

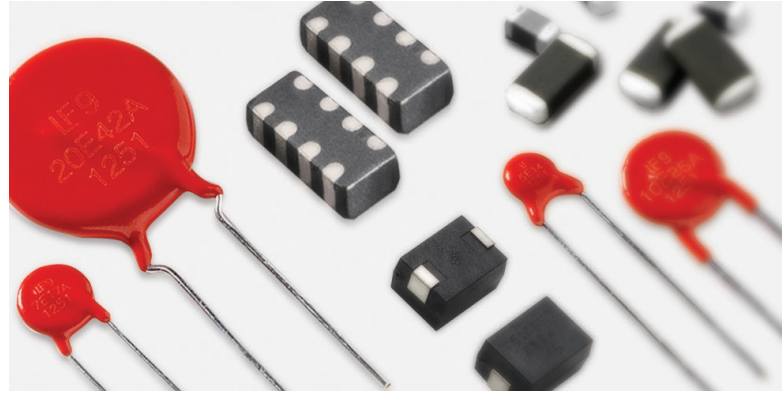

Expertise Applied | Answers Delivered



PRODUCT
CATALOG
& DESIGN
GUIDE









Varistor

Metal-Oxide Varistor (MOV)

TABLE OF CONTENTS

Introduction to Overvoltage Suppression
 Varistor Characteristics, Terms and Consideration Factors
 Varistor Connection Examples
 Varistor Selection Worksheet
 Agency Standards
 Legal Disclaimers

Series Name ¹	Image	Technology Type	Operating AC Voltage Range	Operating DC Voltage Range	Peak Current Range ² (A)	Peak Energy Range (J)	Operating Temperature Range	Lines Protected	Mount/Form Factor	Disc Size	Agency Approvals													
											UL	CSA	VDE	CECC	QPL	RoHS	Lead Free	Halogen Free						
Surface Mount MLVs and MOVs:																								
MHS		Multi-Layer Zinc Oxide (MLV)		9 - 42			-55 to +125°C	1	Surface Mount	Not Applicable						•								
MLE			18																		•			
0201 MLA			5.5																			•		
MLA			2.5 - 107	3.5 - 120	4 - 500	0.02 - 2.5																•		
MLA Automotive			2.5 - 40	3.5 - 48	500	0.1 - 2.5																•		
AUML				18 - 48		1.5 - 25																•		
MLN		Zinc Oxide (MOV)	4 - 14	5.5 - 18	30	0.05 - 0.10	-55 to +85°C	4									•							
CH			14 - 275	18 - 369	100 - 400	1.0 - 8.0														•				
SM7			50 - 510	68 - 675	1200	10 - 40															•	•		
SM20			20 - 320	26 - 420	6500	165															•	•	•	
Radial Leaded MOVs:																								
LV UltraMOV [®] Varistor		Zinc Oxide	11 - 95	14 - 127	500 - 10000	0.8 - 150	-55 to +85°C	1	Radial Leaded	5, 7, 10, 14, 20mm							•	•	•					
UltraMOV [®] Varistor			130 - 625	170 - 825	1750 - 10000	12.5 - 400				7, 10, 14, 20mm	•	•	•	•						•	•	•		
UltraMOV [®] 25S Varistor			115 - 750	150 - 970	22000	230 - 890				25mm	•	•									•	•		
C-III			130 - 1000		3500 - 10000	40 - 530				10, 14, 20mm	•	•	•	•							•	•	•	
LA			130 - 1000	175 - 1200	1200 - 6500	11 - 360				7, 10, 14, 20mm	•	•	•	•							•	•	•	
ZA			4 - 460	5.5 - 615	50 - 6500	0.1 - 52				5, 7, 10, 14, 20mm	•		•	•							•	•	•	
AUMOV [®] Varistor			14 - 42	16 - 50	400 - 5000	1.0 to 140				5, 7, 10, 14, 20mm	•													
HMOV			11 - 625	14 - 825		4.2 - 490				10, 14, 20mm	•											•	•	•
Industrial High Energy Terminal MOVs:																								
BA/BB		Zinc Oxide	130 - 2800	175 - 3500	50000 - 70000	450 - 10000	-55 to +85°C	1	Screw / Clip Terminals	60mm	•							•						
DA/DB			130 - 750	175 - 970	40000	270 - 1050				40mm	•										•			
HA			110 - 750	148 - 970	25000 - 40000	160 - 1050				32, 40mm	•	•									•	•	•	
HB34, HF34, HG34			110 - 750	148 - 970	40000	220 - 1050					34mm	•	•									•	•	•
DHB34			110 - 750	148 - 970	40000	220 - 1050				34mm	•	•										•	•	•
CA			250 - 2800	330 - 3500	20000 - 70000	880 - 10000				Bare Disc	60mm													
Specialty Application MOVs:																								
MA		Zinc Oxide	9 - 264	13 - 365	40 - 100	0.06 - 1.7	-55 to +85°C	1	Axial Leaded	Not Applicable								•	•	•				
RA			4 - 275	5.5 - 369	100 - 6500	0.4 - 160	-55 to +125°C		Inline Radial Leads	Not Applicable	•	•							•	•				
High Reliability			130 - 320	175 - 420	6000	50 - 120	-55 to +85°C		(Varies)	7, 10, 14, 20mm									•					
Thermally Protected MOVs:																								
TMOV [®] Varistor/ iTMOV [®] Varistor		Zinc Oxide	115 - 750	150 - 970	6000 - 10000	35 - 480	-55 to +85°C	1	Radial Leaded	14, 20mm	•		•	•				•	•					
TMOV [®] 25S Varistor			115 - 750	150 - 970	20000	170 - 670				25mm	•		•	•							•	•		
TMOV [®] 34S Varistor			115 - 750	150 - 970	40000	280 - 1200				34mm	•		•	•								•	•	
SMOV [®] 25S Varistor			115 - 750	150 - 970	20000	170 - 670					25mm												•	•
SMOV [®] 34S Varistor			115 - 750	150 - 970	40000	280 - 1200				34mm													•	•
FBMOV			115 - 750	150 - 970	40000	340 - 1340				-55 to +85°C	Bolt Terminal											•		

(1) Detailed information about most product series listed here can be found on our web.

(2) Not an applicable parameter for Crowbar devices

(3) AUMOV[®] Varistor: Energy rating (auto load dump) for impulse duration of 40ms minimum to one half of peak current, 60 second interval (ISO7637-2 5a).

Introduction to Overvoltage Suppression

To assure reliable operation, transient voltage suppression should be considered at early stages of the design process. This can be a complex task as electronic components are increasingly sensitive to stray electrical transients. The designer must define the types of transient threats and determine what applications are needed while meeting the product agency norms and standards.

Varistors are increasingly used as the front-line solution for transient surge protection. Littelfuse provides expertise to the designer and offers the broadest range of circuit protection technologies to choose from.

Littelfuse varistors are available in a variety of forms to serve a wide range of applications. Options include ultra small surface mount multi-layer suppressor (MLV) devices for small electronics applications, and traditional mid-range metal-oxide (MOV) radial and axial leaded devices for protection of small machinery, power sources and components. Littelfuse also offers larger terminal mount MOVs for industrial applications.

A more recent innovation to the the Littelfuse product line, MLVs address a specific part of the transient voltage spectrum – the circuit board level environment

where, although lower in energy, transients from ESD, inductive load switching, and even lightning surge remnants would otherwise reach sensitive integrated circuits. Each of these events can relate to a product's ElectroMagnetic Compatibility (EMC), or its immunity to transients that could cause damage or malfunction.

Littelfuse offers five distinct versions of MLVs including the MHS Series ESD Suppressor for high data rates, the ML Series which supports the broadest application range, the MLE Series intended for ESD while providing filter functions, the MLN Series Quad Array in a 1206 & 0805 chip and the AUML Series characterized for the specific transients found in automotive electronic systems.

This catalog and design guide includes selection tables, technology tutorials, and detailed product technical information, to aid you in choosing the correct Littelfuse Varistor to serve your application.

Please visit www.littelfuse.com regularly to find the most current Littelfuse varistor product information.

Additional design support information can be found at www.littelfuse.com/design-support.html

Varistor Application Guides

MARKET SEGMENT	TYPICAL APPLICATIONS AND CIRCUIT EXAMPLES		DEVICE FAMILY OR SERIES	TECHNOLOGY	SURFACE MOUNT PRODUCTS
Low Voltage, Board Level Products	<ul style="list-style-type: none"> Hand-Held/Portable Devices EDP Computer I/O Port and Interfaces 	<ul style="list-style-type: none"> Controllers Instrumentation Remote Sensors Medical Electronics, Etc. 	CH	MOV	√
			MA, ZA, RA	MOV	
			ML, MLE, MLN, MHS	MLV	√
AC Line, TVSS Products	<ul style="list-style-type: none"> UPS AC Panels AC Power Taps TVSS Devices AC Appliance/Controls 	<ul style="list-style-type: none"> Power Meters Power Supplies Circuit Breakers Consumer Electronics 	TMOV®, UltraMOV™, C-111, LA, HA, HB, HG, HF, DHB, TMOV34S®, RA	MOV	
			CH	MOV	√
Automotive Electronics	<ul style="list-style-type: none"> ABS EEC Instrument Center Air Bag Window Control/ Wiper Modules 	<ul style="list-style-type: none"> Body Controllers Multiplex Bus EFI 	CH	MOV	√
			ZA	MOV	
			AUML, ML, MLE, MLN, MHS	MLV	√
Telecommunications Products	<ul style="list-style-type: none"> Cellular/Cordless Phone Modems Secondary Phone Line Protectors Data Line Connectors 	<ul style="list-style-type: none"> Repeaters Line Cards COE T1/E1/ISDN 	CH	MOV	√
			ZA	MOV	
			ML, MLE, MLN, MHS	MLV	√
Industrial High Energy AC Products	<ul style="list-style-type: none"> High Current Relays Solenoids Motor Drives AC Distribution Panels 	<ul style="list-style-type: none"> Robotics Large Motors/Pumps/Compressors 	DA/DB, BA/BB, CA, HA, HB, HC, HG, HF, DHB, TMOV34S®	MOV	

Available in both surfacemount and through-hole packages.

Introduction to Overvoltage Suppression (continued)

Transient Threats – What Are Transients?

Voltage transients are defined as short duration surges of electrical energy and are the result of the sudden release of energy that was previously stored, or induced by other means, such as heavy inductive loads or lightning strikes. In electrical or electronic circuits, this energy can be released in a predictable manner via controlled switching actions, or randomly induced into a circuit from external sources.

Repeatable transients are frequently caused by the operation of motors, generators, or the switching of reactive circuit components. Random transients, on the other hand, are often caused by Lightning (Figure 1) and Electrostatic Discharge (ESD) (Figure 2). Lightning and ESD generally occur unpredictably, and may require elaborate monitoring to be accurately measured, especially if induced at the circuit board level. Numerous electronics standards groups have analyzed transient voltage occurrences using accepted monitoring or testing methods. The key characteristics of several transients are shown below in Table 1.

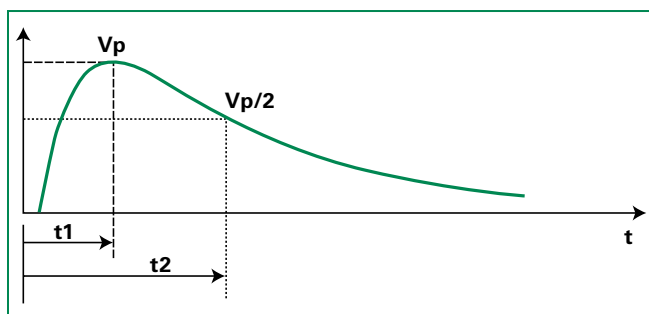

Figure 1. Lightning Transient Waveform

	VOLTAGE	CURRENT	RISE-TIME	DURATION
Lighting	25kV	20kA	10 μ s	1ms
Switching	600V	500A	50 μ s	500ms
EMP	1kV	10A	20ns	1ms
ESD	15kV	30A	<1ns	100ns

Table 1. Examples of transient sources and magnitude

Characteristics of Transient Voltage Spikes

Transient voltage spikes generally exhibit a "double exponential" wave form, shown in Figure 1 for lightning and figure 2 for ESD. The exponential rise time of lightning is in the range 1.2 μ s to 10 μ s (essentially 10% to 90%) and the duration is in the range of 50 μ s to 1000 μ s (50% of peak values). ESD on the other hand, is a much shorter duration event. The rise time has been characterized at less than 1 ns. The overall duration is approximately 100ns.

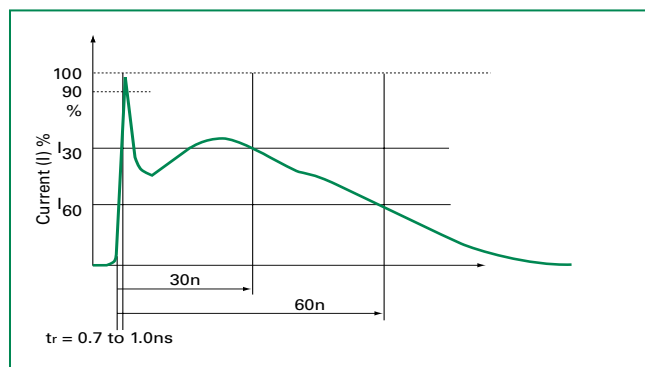

Figure 2. ESD Test Waveform

Why are Transients of Increasing Concern?

Component miniaturization has resulted in increased sensitivity to electrical stresses. Microprocessors for example, have structures and conductive paths which are unable to handle high currents from ESD transients. Such components operate at very low voltages, so voltage disturbances must be controlled to prevent device interruption and latent or catastrophic failures. Sensitive devices such as microprocessors are being adopted at an exponential rate. Microprocessors are beginning to perform transparent operations never before imagined. Everything from home appliances, such as dishwashers, to industrial controls and even toys, have increased the use of microprocessors to improve functionality and efficiency.

Vehicles now employ many electronics systems to control the engine, climate, braking and, in some cases, steering systems. Some of the innovations are designed to improve efficiency, but many are safety related, such as ABS and traction control systems. Many of the features in appliances and automobiles use modules which present transient threats (such as electric motors). Not only is the general environment hostile, but the equipment or appliance can also be sources of threats. For this reason, careful circuit design and the correct use of overvoltage protection technology will greatly improve the reliability and safety of the end application. Table 2 shows the vulnerability of various component technologies.

Device Type	Vulnerability (volts)
VMOS	30-1800
MOSFET	100-200
GaAsFET	100-300
EPROM	100
JFET	140-7000
CMOS	250-3000
Schottky Diodes	300-2500
Bipolar Transistors	380-7000
SCR	680-1000

Table 2: Range of device vulnerability.

Introduction to Overvoltage Suppression (continued)

Transient Voltage Scenarios

ESD (Electrostatic Discharge)

Electrostatic discharge is characterized by very fast rise times and very high peak voltages and currents. This energy is the result of an imbalance of positive and negative charges between objects.

Below are some examples of the voltages which can be generated, depending on the relative humidity (RH):

- **Walking across a carpet:**
35kV @ RH = 20%; 1.5kV @ RH = 65%
- **Walking across a vinyl floor:**
12kV @ RH = 20%; 250V @ RH = 65%
- **Worker at a bench:**
6kV @ RH = 20%; 100V @ RH = 65%
- **Vinyl envelopes:**
7kV @ RH = 20%; 600V @ RH = 65%
- **Poly bag picked up from desk:**
20kV @ RH = 20%; 1.2kV @ RH = 65%

Referring to Table 2 on the previous page, it can be seen that ESD that is generated by everyday activities can far surpass the vulnerability threshold of standard semiconductor technologies. Figure 2 shows the ESD waveform as defined in the IEC 61000-4-2 test specification.

Inductive Load Switching

The switching of inductive loads generates high energy transients which increase in magnitude with increasingly heavy loads. When the inductive load is switched off, the collapsing magnetic field is converted into electrical energy which takes the form of a double exponential transient. Depending on the source, these transients can be as large as hundreds of volts and hundreds of Amps, with duration times of 400ms.

Typical sources of inductive transients are:

- **Generator**
- **Motor**
- **Relay**
- **Transformer**

These examples are extremely common in electrical and electronic systems. Because the sizes of the loads vary according to the application, the wave shape, duration, peak current and peak voltage are all variables which exist in real world transients. Once these variables can be approximated, a suitable suppressor technology can be selected.

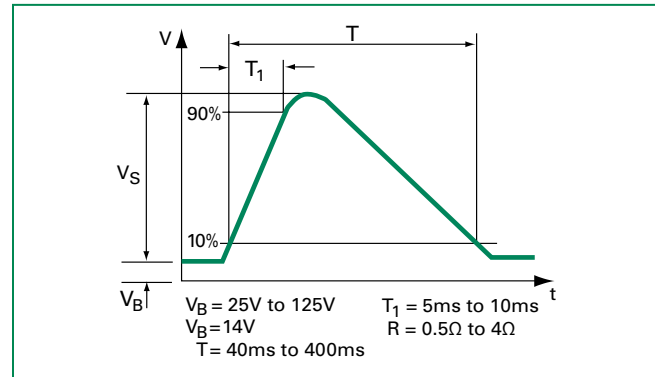

Figure 3. Automotive Load Dump

Figure 3, shows a transient which is the result of stored energy within the alternator of an automobile charging system. A similar transient can also be caused by other DC motors in a vehicle. For example, DC motors power amenities such as power locks, seats and windows. These various applications of a DC motor can produce transients that are just as harmful to the sensitive electronic components as transients created in the external environment.

Lightning Induced Transients

Even though a direct strike is clearly destructive, transients induced by lightning are not the result of a direct strike. When a lightning strike occurs, the event creates a magnetic field which can induce transients of large magnitude in nearby electrical cables.

Figure 4, shows how a cloud-to-cloud strike will effect not only overhead cables, but also buried cables. Even a strike 1 mile distant (1.6km) can generate 70V in electrical cables.

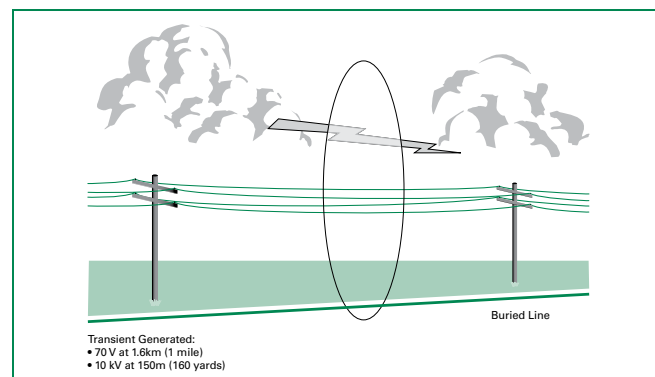

Figure 4. Cloud-to-Cloud Lightning Strike

Introduction to Overvoltage Suppression (continued)

Figure 5 shows the effect of a cloud-to-ground strike: the transient-generating effect is far greater.

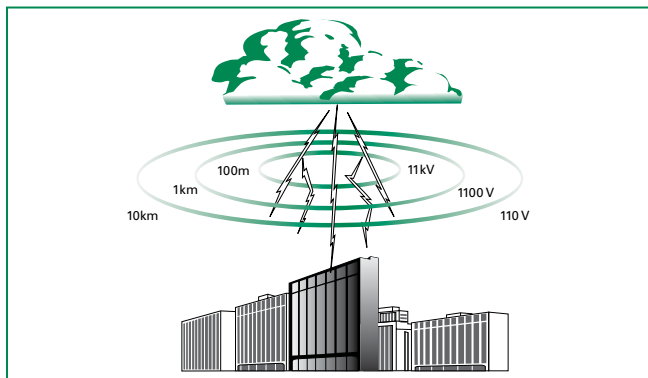

Figure 5. Cloud-to-Ground Lightning Strike

Figure 6, shows a typical current waveform for induced lightning disturbances.

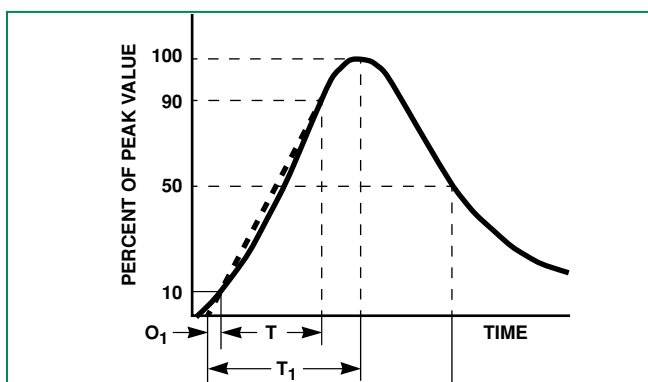

Figure 6. Peak Pulse Current Test Waveform

Technological Solutions for Transient Threats

Because of the various types of transients and applications, it is important to correctly match the suppression solution to the different applications. Littelfuse offers the broadest range of circuit protection technologies to ensure that you get the proper solution for your application. Please consult our online library of Application Notes and Design Notes for further information on common design issues encountered at www.littelfuse.com.

Metal Oxide Varistors and Multi-Layered Varistors

Varistors are voltage dependent, nonlinear devices which have electrical characteristics similar to back-to-back Zener diodes. They are composed primarily of ZnO with small additions of other metal oxides such as Bismuth, Cobalt, Magnese and others. The Metal Oxide Varistor or "MOV" is sintered during the manufacturing operation into a ceramic semiconductor and results in a crystalline microstructure that allows MOVs to dissipate very high levels of transient energy across the entire bulk of the device. Therefore, MOVs are typically used for the suppression of lightning and other high energy transients found in industrial or AC line applications. Additionally, MOVs are used in DC circuits such as low voltage power supplies and automobile applications. Their manufacturing process permits many different form factors with the radial leaded disc being the most common.

Multilayer Varistors or MLVs are constructed of ZnO material similar to standard MOVs, however, they are fabricated with interweaved layers of metal electrodes and supplied in leadless ceramic packages. As with standard MOVs, Multilayers transition from a high impedance to a conduction state when subjected to voltages that exceed their nominal voltage rating. MLVs are constructed in various chip form sizes and are capable of significant surge energy for their physical size. Thus, data line and power supply suppression are achieved with one technology.

The following parameters apply to Varistors and/or Multilayer Varistors and should be understood by the circuit designer to properly select a device for a given application.

The three Littelfuse technologies described offer a comprehensive choice for the designer. Reviewing the attributes of each can result in a suitable ESD suppression solution for most applications. See the individual data sheets for specific electrical and mechanical information.

Varistor Characteristics, Terms and Consideration Factors

The varistor body structure consists of a matrix of conductive ZnO grains separated by grain boundaries providing P-N junction semiconductor characteristics. These boundaries are responsible for blocking conduction at low voltages and are the source of the nonlinear electrical conduction at higher voltages.

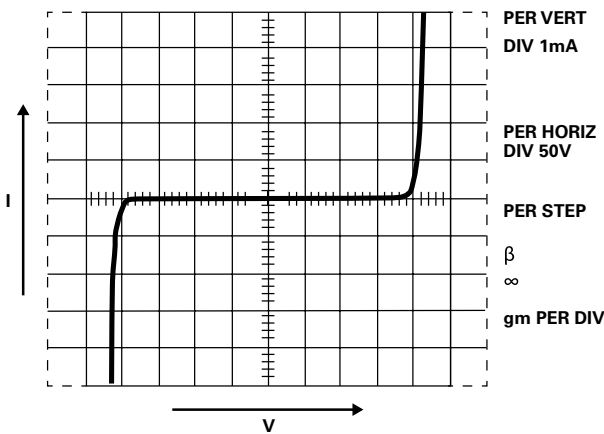

FIGURE 1. TYPICAL VARISTOR V-I CHARACTERISTIC

The symmetrical, sharp breakdown characteristics shown in Figure 1, enable the varistor to provide excellent transient suppression performance. When exposed to high voltage transients the varistor impedance changes many orders of magnitude from a near open circuit to a highly conductive level, thus clamping the transient voltage to a safe level. The potentially destructive energy of the incoming transient pulse is absorbed by the varistor, thereby protecting vulnerable circuit components.

Since electrical conduction occurs, in effect, between ZnO grains distributed throughout the bulk of the device, the Littelfuse Varistor is inherently more rugged than its single P-N junction counterparts, such as Zener diodes. In the varistor, energy is absorbed uniformly throughout the body of the device with the resultant heating spread evenly through its volume. Electrical properties are controlled mainly by the physical dimensions of the varistor body which is sintered in various form factors such as discs, chips and tubes. The energy rating is determined by volume, voltage rating by thickness or current flow path length, and current capability by area measured normal to the direction of current flow.

Physical Properties

MOVs are designed to protect sensitive circuits against external transients (lightning) and internal transients (inductive load switching, relay switching and capacitor discharges). And other high level transients found in industrial, AC line application or lower level transients found in automotive DC line applications with peak current rating ranging from 20A to 500A and peak energy rating from 0.05J – 2.5J.

An attractive property of the MOV is that the electrical characteristics are related to the bulk of the device. Each ZnO grain of the ceramic acts as if it has a semiconductor junction at the grain boundary. A cross-section of the material is shown in Figure 2, which illustrates the ceramic microstructure. Varistors are fabricated by forming and sintering Zinc Oxide-based powders into ceramic parts. These parts are then electroded with either thick film Silver or arc/flame sprayed metal.

The ZnO grain boundaries can be clearly observed. Since the nonlinear electrical behavior occurs at the boundary of each semiconducting ZnO grain, the varistor can be considered a "multi-junction" device composed of many series and parallel connections of grain boundaries. Device behavior may be analyzed with respect to the details of the ceramic microstructure. Mean grain size and grain size distribution play a major role in electrical behavior.

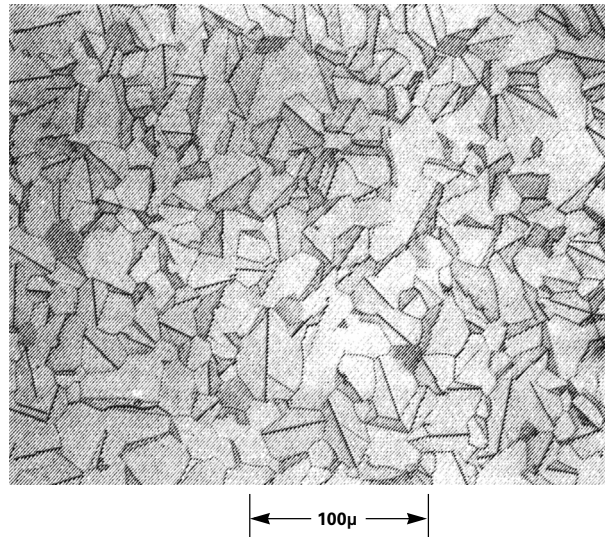

FIGURE 2. OPTICAL PHOTOMICROGRAPH OF A POLISHED AND ETCHED SECTION OF A VARISTOR

Varistor Characteristics, Terms and Consideration Factors (continued)

Varistor Microstructure

The bulk of the varistor between contacts is comprised of ZnO grains of an average size "d" as shown in the schematic model of Figure 3. Resistivity of the ZnO is <0.3 Ω-cm.

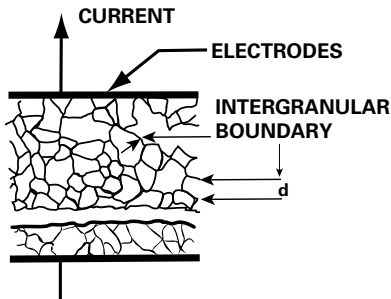

FIGURE 3. SCHEMATIC DEPICTION OF THE MICROSTRUCTURE OF A METAL-OXIDE VARISTOR, GRAINS OF CONDUCTING ZnO (AVERAGE SIZE d) ARE SEPARATED BY INTERGRANULAR BOUNDARIES.

Designing a varistor for a given nominal varistor voltage, (V_N), is basically a matter of selecting the device thickness such that the appropriate number of grains, (n), are in series between electrodes. In practice, the varistor material is characterized by a voltage gradient measured across its thickness by a specific volts/mm value. By controlling composition and manufacturing conditions the gradient remains fixed. Because there are practical limits to the range of thicknesses achievable, more than one voltage gradient value is desired. By altering the composition of the metal oxide additives it is possible to change the grain size "d" and achieve the desired result.

A fundamental property of the ZnO varistor is that the voltage drop across a single interface "junction" between grains is nearly constant. Observations over a range of compositional variations and processing conditions show a fixed voltage drop of about 2V-3V per grain boundary junction. Also, the voltage drop does not vary for grains of different sizes. It follows, then, that the varistor voltage will be determined by the thickness of the material and the size of the ZnO grains. The relationship can be stated very simply as follows:

$$\text{and, varistor thickness, } D = \frac{\text{between electrodes}}{(n + 1)d} \approx \frac{V_N \times d}{3}$$

where, d = average grain size

$$R_X = \frac{V}{I}$$

The varistor voltage, (V_N), is defined as the voltage across a varistor at the point on its V-I characteristic where the transition (v) is complete from the low-level linear region to the highly nonlinear region. For standard measurement purposes, it is arbitrarily defined as the voltage at a current of 1mA. Some typical values of dimensions for Littelfuse Varistors are given in Table 1.

TABLE 1.

VARISTOR VOLTAGE	AVERAGE GRAIN SIZE	n	GRADIENT	DEVICE THICKNESS
			V/mm AT 1mA	mm
150V _{RMS}	20	75	150	1.5
25V _{RMS}	80 (Note)	12	39	1.0

NOTE: Low voltage formulation.

Theory of Operation

Because of the polycrystalline nature of metal-oxide semiconductor varistors, the physical operation of the device is more complex than that of conventional semiconductors. Intensive measurement has determined many of the device's electrical characteristics, and much effort continues to better define the varistor's operation. However from the user's viewpoint, this is not nearly as important as understanding the basic electrical properties as they relate to device construction.

The key to explaining metal-oxide varistor operation lies in understanding the electronic phenomena occurring near the grain boundaries, or junctions between the ZnO grains. While some of the early theory supposed that electronic tunneling occurred through an insulating second phase layer at the grain boundaries, varistor operation is probably better described by a series-parallel arrangement of semiconducting diodes. In this model, the grain boundaries contain defect states which trap free electrons from the n-type semiconducting ZnO grains, thus forming a space charge depletion layer in the ZnO grains in the region adjacent to the grain boundaries. (See reference notes on the last page of this section).

Evidence for depletion layers in the varistor is shown in Figure 4, where the inverse of the capacitance per boundary squared is plotted against the applied voltage per boundary. This is the same type of behavior observed carrier concentration, N , was determined to be about 2×10^{17} per cm^3 . In addition, the width of the depletion layer was calculated to be about 1000 Angstrom units. Single junction studies also support the diode model.

It is these depletion layers that block the free flow of carriers and are responsible for the low voltage insulating behavior in the leakage region as depicted in Figure 5. The leakage current is due to the free flow of carriers across

Varistor Characteristics, Terms and Consideration Factors (continued)

the field lowered barrier, and is thermally activated, at least above about 25°C. For semiconductor abrupt P-N junction diodes. The relationship is:

$$\frac{1}{C^2} = \frac{2(V_b + V)}{q\epsilon s N}$$

Where:

- (**V_b**) = barrier voltage,
- (**V**) = applied voltage,
- (**q**) = electron charge,
- (**εs**) = semiconductor permittivity and
- (**N**) = carrier concentration.

From this relationship the ZnO carrier concentration, **N**, was determined to be about 2 x 10¹⁷ per cm³.

In addition, the width of the depletion layer was calculated to be about 1000 Angstrom units. Single junction studies also support the diode model.

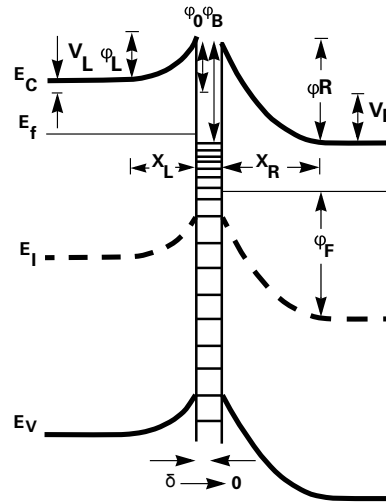

FIGURE 5. ENERGY BAND DIAGRAM OF A ZnO-GRAINBOUNDARY-ZnO JUNCTION

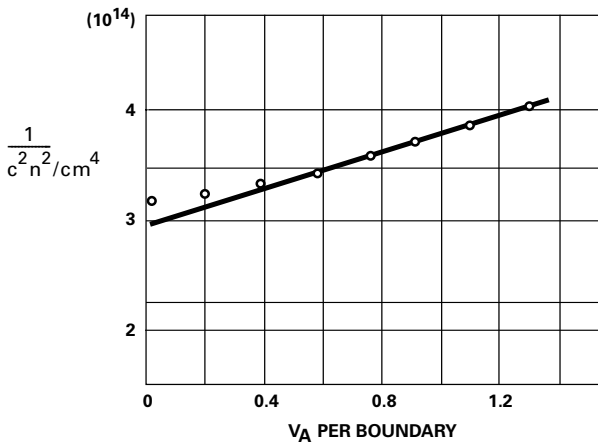

FIGURE 4. CAPACITANCE-VOLTAGE BEHAVIOR OF VARISTOR RESEMBLES A SEMICONDUCTOR ABRUPT-JUNCTION REVERSED BIASED DIODE Nd ~ 2 x 10¹⁷/cm³

Figure 5, shows an energy band diagram for a ZnO-grain boundary-ZnO junction . The left-hand grain is forward biased, **V_L**, and the right side is reverse biased to **V_R**. The depletion layer widths are **X_L** and **X_R**, and the respective barrier heights are **f_L** and **f_R**. The zero biased barrier height is **f₀**. As the voltage bias is increased, **f_L** is decreased and **f_R** is increased, leading to a lowering of the barrier and an increase in conduction.

The barrier height **f_L** of a low voltage varistor was measured as a function of applied voltage, and is presented in Figure 6. The rapid decrease in the barrier at high voltage represents the onset of nonlinear conduction.

Transport mechanisms in the nonlinear region are very complicated and are still the subject of active research. Most theories draw their inspiration from semiconductor transport theory and is not covered in detail in this document.

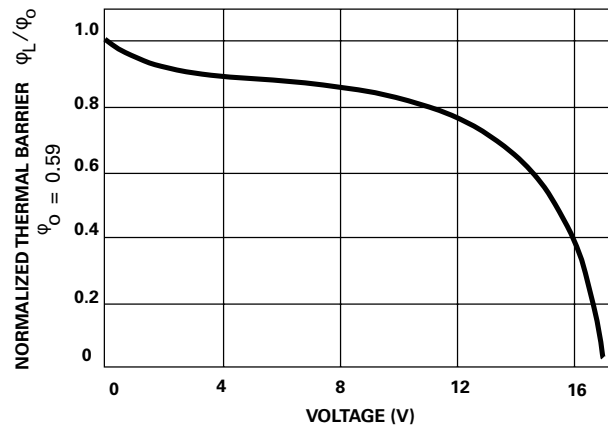

FIGURE 6. THERMAL BARRIER vs APPLIED VOLTAGE

Varistor Characteristics, Terms and Consideration Factors (continued)

Varistor Construction

The process of fabricating a Littelfuse Varistor is illustrated in the flow chart of Figure 7. The starting material may differ in the composition of the additive oxides, in order to cover the voltage range of product.

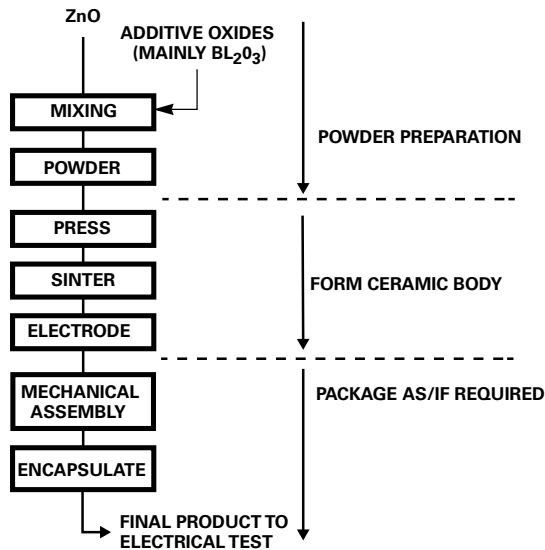

FIGURE 7. SCHEMATIC FLOW DIAGRAM OF LITTELFUSE VARISTOR FABRICATION

Device characteristics are determined at the pressing operation. The powder is pressed into a form of predetermined thickness in order to obtain a desired value of nominal voltage. To obtain the desired ratings of peak current and energy capability, the electrode area and mass of the device are varied. The range of diameters obtainable in disc product offerings is listed here:

Nominal Disc Diameter—mm												
3	5	7	8	10	14	16	20	22	25	32	34	62

Of course, other shapes, such as rectangles, are also possible by simply changing the press dies. Other ceramic fabrication techniques can be used to make different shapes. For example, rods or tubes are made by extruding and cutting to length. After forming, the green (i.e., unfired) parts are placed in a kiln and sintered at peak temperatures in excess of 1200°C. The Bismuth oxide is molten above 825°C, assisting in the initial densification of the polycrystalline ceramic. At higher temperatures, grain growth occurs, forming a structure with controlled grain size.

Electroding is accomplished, for radial and chip devices, by means of thick film silver fired onto the ceramic surface. Wire leads or strap terminals are then soldered in place. A conductive epoxy is used for connecting leads to the axial 3mm discs. For the larger industrial devices (40mm and

60mm diameter discs) the contact material is arc sprayed Aluminum, with an overspray of Copper if necessary to give a solderable surface.

Many encapsulation techniques are used in the assembly of the various Littelfuse Varistor packages. Most radials and some industrial devices (HA Series) are epoxy coated in a fluidized bed, whereas epoxy is “spun” onto the axial device.

Radials are also available with phenolic coatings applied using a wet process. The PA Series package consists of plastic molded around a 20mm disc subassembly. The RA, DA and DB Series devices are all similar in that they all are composed of discs or chips, with tabs or leads, encased in a molded plastic shell filled with epoxy. Different package styles allow variation in energy ratings, as well as in mechanical mounting.

TABLE 2. BY-TYPE CERAMIC DIMENSIONS

PACKAGE TYPE	SERIES	CERAMIC DIMENSIONS
Leadless Surface Mount	CH, AUML†, ML†, MLE†, MLN† Series	5mm x 8mm Chip, 0603, 0805, 1206, 1210, 1812, 2220
Axial Leaded	MA Series	3mm Diameter Disc
Radial Leaded	ZA, LA, C-III, TMOV®, iTMOV®, UltraMOV™, TMOV25S® Series	5mm, 7mm, 10mm, 14mm, 20mm Diameter Discs
Boxed, Low Profile	RA Series	5mm x 8mm, 10mm x 16mm, 14 x 22 Chips
Industrial Packages	BA, BB Series DA, DB Series DHB Series HA, HB Series HC, HF Series HG Series	32mm, 40mm Diameter Disc, 34mm Square Disc, 40mm Diameter Disc, 60mm Diameter Disc
Industrial Discs	CA Series	60mm Diameter Discs

Figure 9A, 9B and 9C (next page) show construction details of some Littelfuse varistor packages. Dimensions of the ceramic, by package type, are above in Table 2.

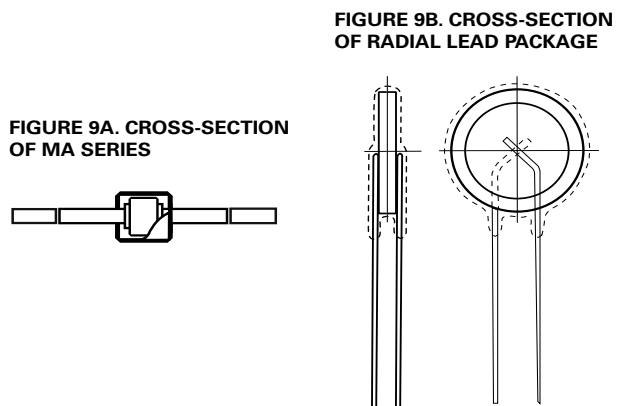

Varistor Characteristics, Terms and Consideration Factors (continued)

FIGURE 9C. PICTORIAL VIEW OF HIGH ENERGY DA, DB AND BA/BB SERIES

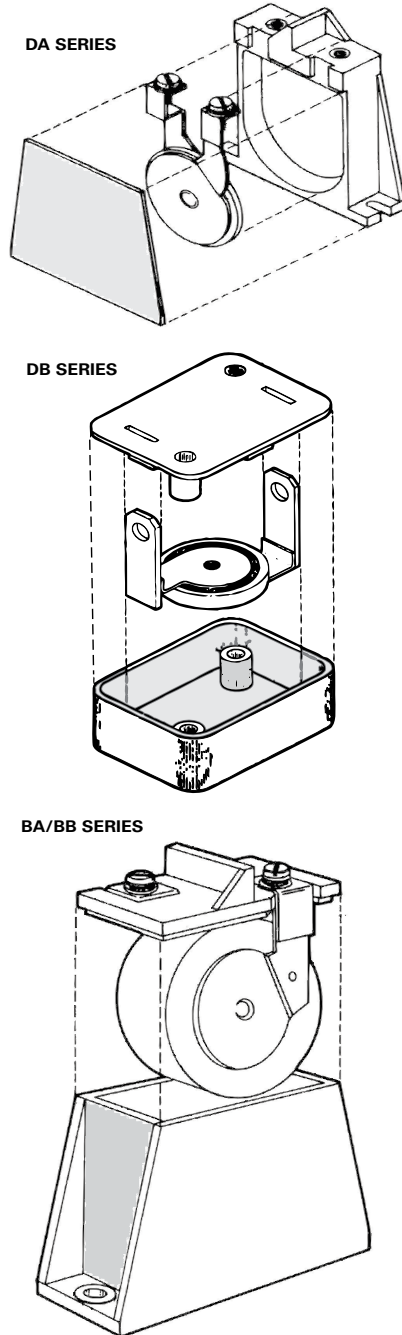

Electrical Characterization Varistor V-I Characteristics

Turning now to the high current upturn region in Figure 10, we see that the V-I behavior approaches an ohmic characteristic. The limiting resistance value depends upon the electrical conductivity of the body of the semiconducting ZnO grains, which have carrier concentrations in the range of 10^{17} to 10^{18} per cm^3 . This would put the ZnO resistivity below $0.3\Omega\text{cm}$.

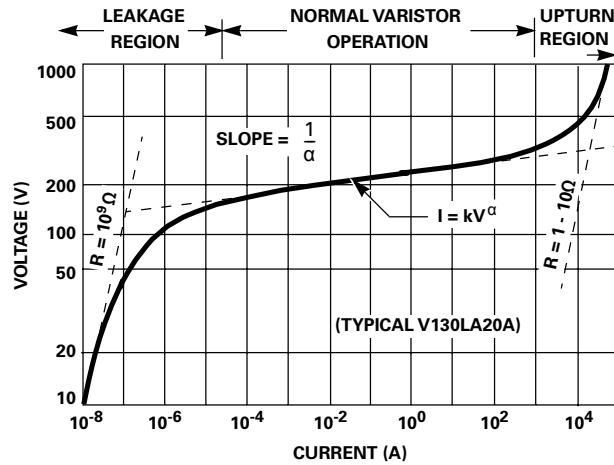

FIGURE 10. TYPICAL VARISTOR V-I CURVE PLOTTED ON LOG-LOG SCALE

Varistor electrical characteristics are conveniently displayed using log-log format in order to show the wide range of the V-I curve. The log format also is clearer than a linear representation which tends to exaggerate the nonlinearity in proportion to the current scale chosen. A typical V-I characteristic curve is shown in Figure 10. This plot shows a wider range of current than is normally provided on varistor data sheets in order to illustrate three distinct regions of electrical operation.

Equivalent Circuit Model

An electrical model for the varistor can be represented by the simplified equivalent circuit of Figure 11.

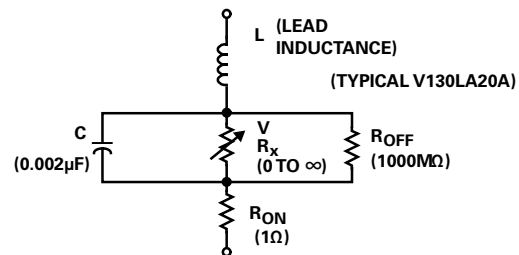

FIGURE 11. VARISTOR EQUIVALENT CIRCUIT MODEL

Varistor Characteristics, Terms and Consideration Factors (continued)

Leakage Region of Operation

At low current levels, the V-I Curve approaches a linear (ohmic) relationship and shows a significant temperature dependence. The varistor is in a high resistance mode (approaching $10^9\Omega$) and appears as an open circuit. The nonlinear resistance component (R_x) can be ignored because (R_{OFF}) in parallel will predominate. Also, (R_{ON}) will be insignificant compared to (R_{OFF}).

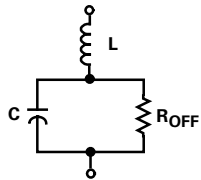

FIGURE 12. EQUIVALENT CIRCUIT AT LOW CURRENTS

For a given varistor device, capacitance remains approximately constant over a wide range of voltage and frequency in the leakage region. The value of capacitance drops only slightly as voltage is applied to the varistor. As the voltage approaches the nominal varistor voltage, the capacitance decreases. Capacitance remains nearly constant with frequency change up to 100 kHz. Similarly, the change with temperature is small, the 25°C value of capacitance being well with +/-10% from -40°C to +125°C.

The temperature effect of the V-I characteristic curve in the leakage region is shown in Figure 13. A distinct temperature dependence is noted.

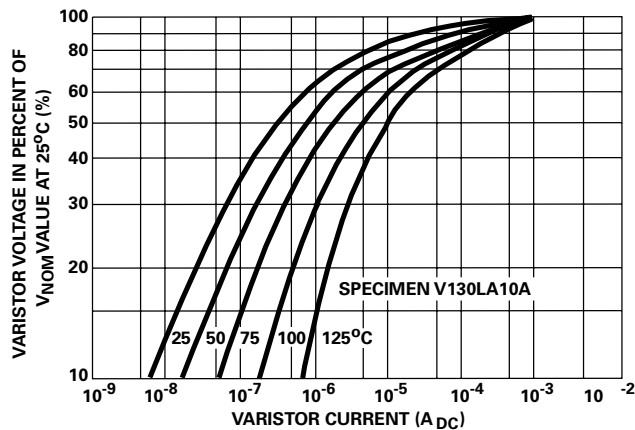

FIGURE 13. TEMPERATURE DEPENDENCE OF THE CHARACTERISTIC CURVE IN THE LEAKAGE REGION

The relation between the leakage current (I) and temperature (T) is

$$I = I_0 \epsilon^{-V_B/kT}$$

where: $I_0 = \text{constant}$
 $k = \text{Boltzmann's Constant}$
 $V_B = 0.9eV$

The temperature variation, in effect, corresponds to a change in (R_{OFF}). However, (R_{OFF}) remains at a high resistance value even at elevated temperatures. For example, it is still in the range of 10MΩ to 100MΩ at 125°C.

Although (R_{OFF}) is a high resistance it varies with frequency. The relationship is approximately linear with inverse frequency.

If however, the parallel combination of (R_{OFF}) and (°C) is predominantly capacitive at any frequency of interest. This is because the capacitive reactance also varies approximately linearly with $1/f$.

At higher currents, at and above the mA range, temperature variation becomes minimal. The plot of the temperature coefficient (dV/dT) is given in Figure 14. It should be noted that the temperature coefficient is negative (-) and decreases as current rises. In the clamping voltage range of the varistor ($I > 1A$), the temperature dependency approaches zero.

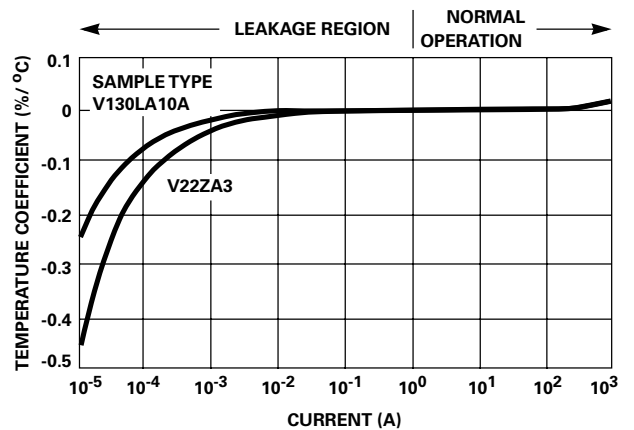

NOTE: Typical Temperature Coefficient of Voltage vs Current, 14mm Size, 55°C to 125°C.

FIGURE 14. RELATION OF TEMPERATURE COEFFICIENT DV/DT TO VARISTOR CURRENT

Varistor Characteristics, Terms and Consideration Factors (continued)

Nominal Varistor Region of Operation

The varistor characteristic follows the equation: $I = kV^a$, where **(k)** is a constant and the exponent **(a)** defines the degree of nonlinearity. Alpha is a figure of merit and can be determined from the slope of the V-I curve or calculated from the formula:

$$\alpha = \frac{\log(I_2/I_1)}{\log(V_2/V_1)}$$

$$= \frac{1}{\log(V_2/V_1)} \text{ for } I_2/I_1 = 1$$

In this region the varistor is conducting and **R_x** will predominate over **C**, **R_{ON}** and **R_{OFF}**. **R_x** becomes many orders of magnitude less than **R_{OFF}** but remains larger than **R_{ON}**.

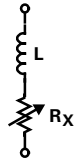

FIGURE 15. EQUIVALENT CIRCUIT AT VARISTOR CONDUCTION

During conduction the varistor voltage remains relatively constant for a change in current of several orders of magnitude. In effect, the device resistance, **R_x**, is changing in response to current. This can be observed by examining the static or dynamic resistance as a function of current. The static resistance is defined by:

$$R_x = \frac{V}{I}$$

and the dynamic resistance by:

$$Z_x = \frac{dv}{di} = V/\alpha I = R_x/\alpha$$

Plots of typical resistance values vs current (**I**) are given in Figure 16A and 16B.

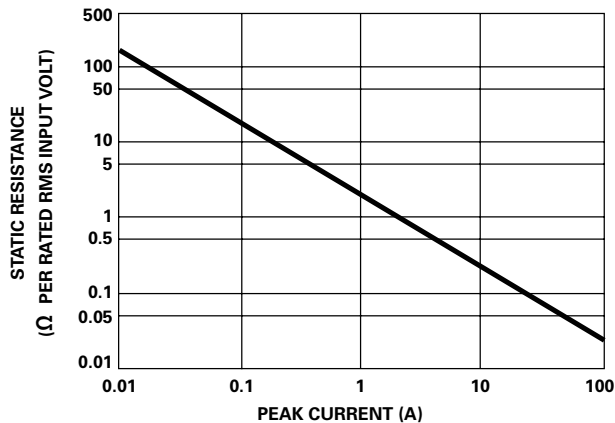

FIGURE 16A. R_x STATIC VARISTOR RESISTANCE FIGURE

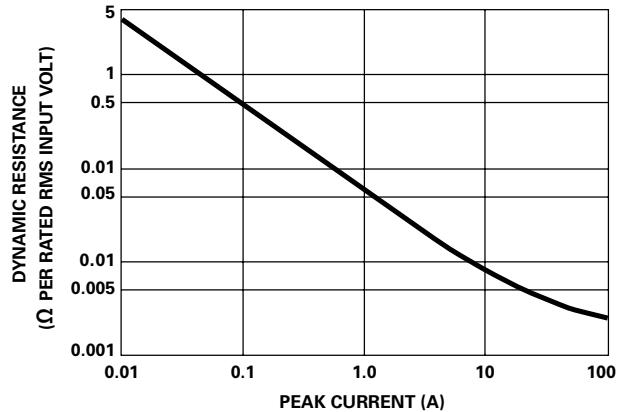

FIGURE 16B. Z_x DYNAMIC VARISTOR RESISTANCE

Upturn Region of Operation

At high currents, approaching the maximum rating, the varistor approximates a short-circuit. The curve departs from the nonlinear relation and approaches the value of the material bulk resistance, about 1Ω-10Ω. The upturn takes place as **R_x** approaches the value of **R_{ON}**. Resistor **R_{ON}** represents the bulk resistance of the **Z_NO** grains. This resistance is linear (which appears as a steeper slope on the log plot) and occurs at currents 50A to 50,000A, depending on the varistor size.

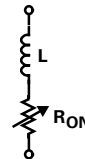

FIGURE 17. EQUIVALENT CIRCUIT AT VARISTOR UPTURN

Varistor Characteristics, Terms and Consideration Factors (continued)

Speed of Response and Rate Effects

The varistor action depends on a conduction mechanism similar to that of other semiconductor devices. For this reason, conduction occurs very rapidly, with no apparent time lag – even into the nanosecond (ns) range. Figure 18, shows a composite photograph of two voltage traces with and without a varistor inserted in a very low inductance impulse generator. The second trace (which is not synchronized with the first, but merely superimposed on the oscilloscope screen) shows that the voltage clamping effect of the varistor occurs in less than **1.0 ns**.

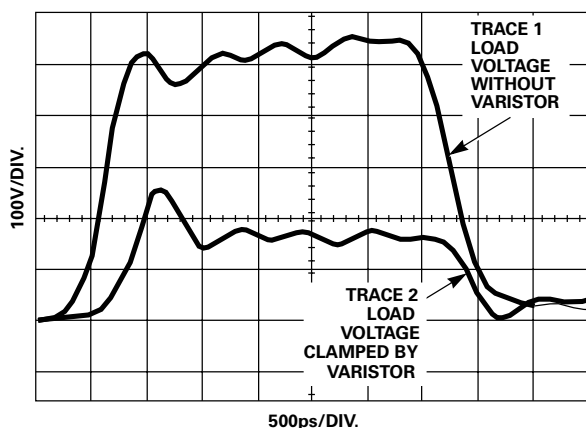

FIGURE 18. RESPONSE OF A ZnO VARISTOR TO A FAST RISE TIME (500ps) PULSE

In the conventional lead-mounted devices, the inductance of the leads would completely mask the fast action of the varistor; therefore, the test circuit for Figure 18, required insertion of a small piece of varistor material in a coaxial line to demonstrate the intrinsic varistor response.

Tests made on lead-mounted devices, even with careful attention to minimizing lead length, show that the voltages induced in the loop formed by the leads contribute a substantial part of the voltage appearing across the terminals of a varistor at high current and fast current rise. Fortunately, the currents which can be delivered by a transient source are invariably slower in rise time than the observed voltage transients. The applications most frequently encountered for varistors involve current rise times longer than $0.5\mu\text{s}$.

Voltage rate-of-rise is not the best term to use when discussing the response of a varistor to a fast impulse (unlike spark gaps where a finite time is involved in switching from nonconducting to conducting state). The response time of the varistor to the transient current that a circuit can deliver is the appropriate characteristic to consider.

The V-I characteristic of Figure 19A, shows how the response of the varistor is affected by the current waveform. From such data, an "overshoot" effect can be defined as being the relative increase in the maximum voltage appearing across the varistor during a fast current rise, using the conventional $8/20\mu\text{s}$ current wave as the reference. Figure 19B, shows typical clamping voltage variation with rise time for various current levels.

FIGURE 19. RESPONSE OF LEAD-MOUNTED VARISTORS TO CURRENT WAVEFORM

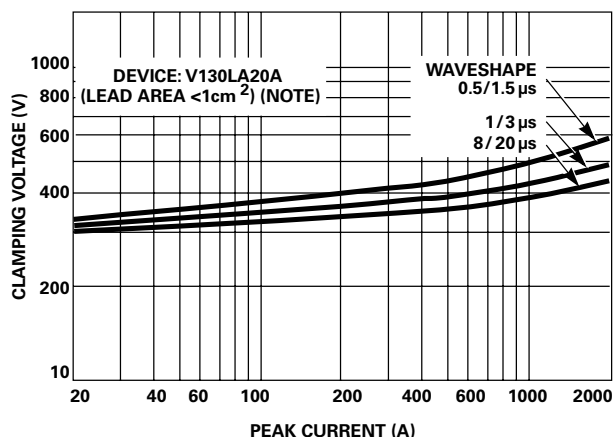

FIGURE 19A. V-I CHARACTERISTICS FOR VARIOUS CURRENT RISE TIMES

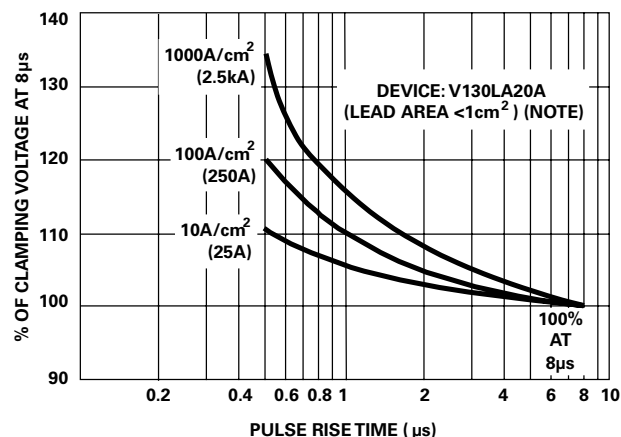

FIGURE 19B. OVERSHOOT DEFINED WITH REFERENCE TO THE BASIC $8/20\mu\text{s}$ CURRENT PULSE

Transient suppressors can be exposed to high currents for short durations in the nanoseconds to millisecond time frame.

Littelfuse Varistors are connected in parallel to the load, and any voltage drop in the leads to the varistor will reduce its effectiveness. Best results are obtained by using short leads that are close together to reduce induced voltages and a low ohmic resistance to reduce $I \cdot R$ drops.

Varistor Characteristics, Terms and Consideration Factors (continued)

Definitions (IEEE Standard C62.33, 1982)

A characteristic is an inherent and measurable property of a device. Such a property may be electrical, mechanical, or thermal, and can be expressed as a value for stated conditions.

A rating is a value which establishes either a limiting capability or a limiting condition (either maximum or minimum) for operation of a device. It is determined for specified values of environment and operation. The ratings indicate a level of stress which may be applied to the device without causing degradation or failure. Varistor symbols are defined on the linear V-I graph illustrated in Figure 20.

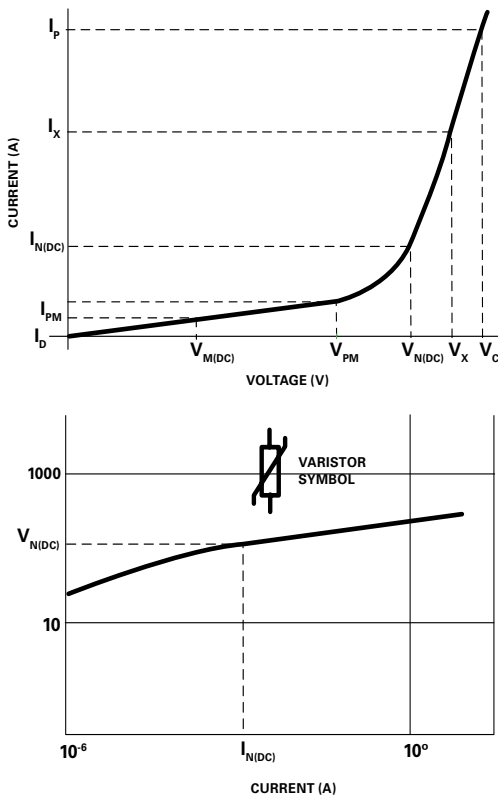

FIGURE 20 - I-V GRAPH ILLUSTRATING SYMBOLS AND DEFINITIONS

Voltage Clamping Device

A clamping device, such as an MOV, refers to a characteristic in which the effective resistance changes from a high to low state as a function of applied voltage. In its conductive state, a voltage divider action is established between the clamping device and the source impedance of the circuit. Clamping devices are generally "dissipative" devices, converting much of the transient electrical energy to heat.

Choosing the most appropriate suppressor depends upon a balance between the application, its operation, voltage transient threats expected and sensitivity levels of the components requiring protection. Form factor/package style also must be considered.

Test Waveform

At high current and energy levels, varistor characteristics are measured, of necessity, with an impulse waveform. Shown in Figure 21, is the ANSI Standard C62.1 wave-shape, an exponentially decaying waveform representative of lightning surges and the discharge of stored energy in reactive circuits.

The 8/20 μ s current wave (8 μ s rise and 20 μ s to 50% decay of peak value) is used as a standard, based on industry practices, for the characteristics and ratings described. One exception is the energy rating (W_{TM}), where a longer waveform of 10/1000 μ s is used. This condition is more representative of the high energy surges usually experienced from inductive discharge of motors and transformers. Varistors are rated for a maximum pulse energy surge that results in a varistor voltage (V_N) shift of less than +/-10% from initial value.

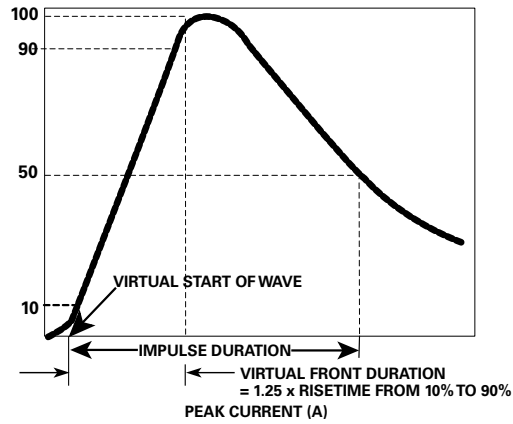

FIGURE 21. DEFINITION OF PULSE CURRENT WAVEFORM

Power Dissipation Ratings

When transients occur in rapid succession the average power dissipation is the energy W_{TM} (watt-seconds) per pulse times the number of pulses per second. The power so developed must be within the specifications shown in the Device Ratings and Characteristics Table for the specific device. Certain parameters must be derated at high temperatures.

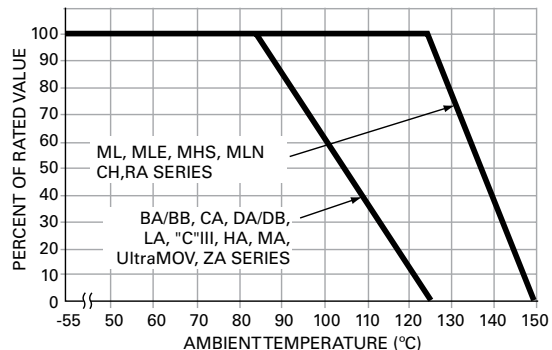

FIGURE 22. DEVICE RATINGS AND CHARACTERISTICS

Varistor Characteristics, Terms and Consideration Factors (continued)

TABLE 3. VARISTOR CHARACTERISTICS (IEEE STANDARD C62.33-1982 SUBSECTION 2.3 AND 2.4)

Terms and Descriptions	Symbol
Clamping Voltage. Peak voltage across the varistor measured under conditions of a specified peak V_C pulse current and specified waveform. NOTE: Peak voltage and peak currents are not necessarily coincidental in time.	V_C
Rated Peak Single Pulse Transient Currents (Varistor). Maximum peak current which may be applied for a single 8/20 μ s impulse, with rated line voltage also applied, without causing device failure.	I_{TM}
Lifetime Rated Pulse Currents (Varistor). Derated values of I_{TM} for impulse durations exceeding that of an 8/20 μ s waveshape, and for multiple pulses which may be applied over device rated lifetime.	-
Rated RMS Voltage (Varistor). Maximum continuous sinusoidal RMS voltage which may be applied.	$V_{M(AC)}$
Rated DC Voltage (Varistor). Maximum continuous DC voltage which may be applied.	$V_{M(DC)}$
DC Standby Current (Varistor). Varistor current measured at rated voltage, $V_{M(DC)}$.	I_D
For certain applications, some of the following terms may be useful.	
Nominal Varistor Voltage. Voltage across the varistor measured at a specified pulsed DC current, $I_{N(DC)}$, of specific duration. $I_{N(DC)}$ of specific duration. $I_{N(DC)}$ is specified by the varistor manufacturer.	$V_{N(DC)}$
Peak Nominal Varistor Voltage. Voltage across the varistor measured at a specified peak AC current, $I_{N(AC)}$, of specific duration. $I_{N(AC)}$ is specified by the varistor manufacturer.	$V_{N(AC)}$
Rated Recurrent Peak Voltage (Varistor). Maximum recurrent peak voltage which may be applied for a specified duty cycle and waveform.	V_{PM}
Rated Single Pulse Transient Energy (Varistor). Energy which may be dissipated for a single impulse of maximum rated current at a specified waveshape, with rated RMS voltage or rated DC voltage also applied, without causing device failure.	W_{TM}
Rated Transient Average Power Dissipation (Varistor). Maximum average power which may be dissipated due to a group of pulses occurring within a specified isolated time period, without causing device failure.	
Varistor Voltage. Voltage across the varistor measured at a given current, I_X .	V_X
Voltage Clamping Ratio (Varistor). A figure of merit measure of the varistor clamping effectiveness as defined by the symbols $(V_C) \div (V_{M(AC)})$, $(V_C) \div (V_{M(DC)})$.	V_C / V_{PM}
Nonlinear Exponent. A measure of varistor nonlinearity between two given operating currents, I_1 and I_2 , as described by $I = kV^a$ where k is a device constant, $I_1 \leq I \leq I_2$, and $a_{12} = (\log I_2 / I_1) \div (\log V_2 / V_1)$	a
Dynamic Impedance (Varistor). A measure of small signal impedance at a given operating point as defined by: $Z_X = (dV_X) \div (dI_X)$	Z_X
Resistance (Varistor). Static resistance of the varistor at a given operating point as defined by: $R_X = (V_X) \div (I_X)$	R_X
Capacitance (Varistor). Capacitance between the two terminals of the varistor measured at C specified frequency and bias.	C
AC Standby Power (Varistor). Varistor AC power dissipation measured at rated RMS voltage $V_{M(AC)}$.	P_D
Voltage Overshoot (Varistor). The excess voltage above the clamping voltage of the device for a given current that occurs when current waves of less than 8 μ s virtual front duration are applied. This value may be expressed as a % of the clamping voltage (V_C) for an 8/20 current wave.	V_{OS}
Response Time (Varistor). The time between the point at which the wave exceeds the clamping voltage level (V_C) and the peak of the voltage overshoot. For the purpose of this definition, clamping voltage as defined with an 8/20 μ s current waveform of the same peak current amplitude as the waveform used for this response time.	-
Overshoot Duration (Varistor). The time between the point voltage level (V_C) and the point at which the voltage overshoot has decayed to 50% of its peak. For the purpose of this definition, clamping voltage is defined with an 8/20 μ s current waveform of the same peak current amplitude as the waveform used for this overshoot duration.	-

Varistor Connection Examples

Single Phase

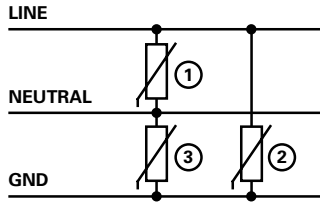

FIGURE 23.

This is the most complete protection one can select, but in many cases only Varistor 1 or Varistor 1 and 2 are selected.

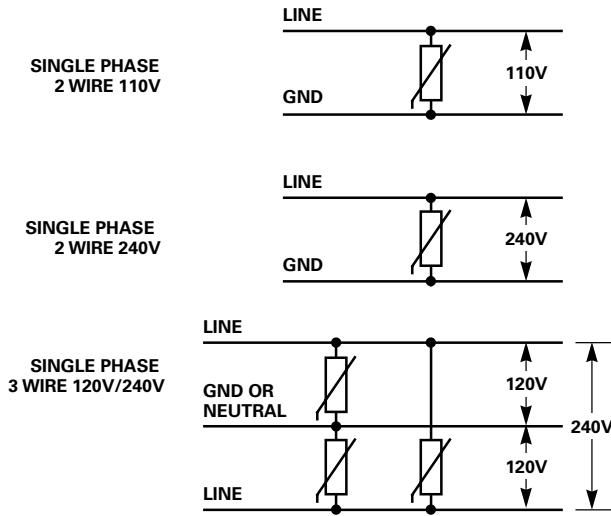

FIGURE 24.

Three Phase

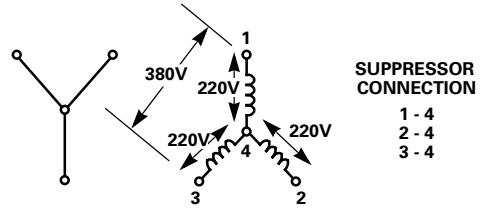

FIGURE 25A. 3 PHASE 220V/380V, UNGROUNDED

- SUPPRESSOR CONNECTION**
- 1 - 4
 - 2 - 4
 - 3 - 4

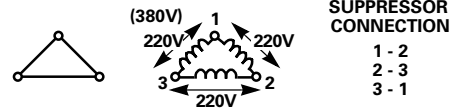

FIGURE 25B. 3 PHASE 220V OR 380V, UNGROUNDED

- SUPPRESSOR CONNECTION**
- 1 - 2
 - 2 - 3
 - 3 - 1

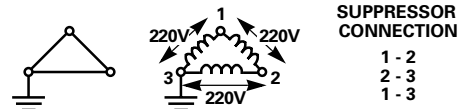

FIGURE 25C. 3 PHASE 220V, ONE PHASE GROUNDED

- SUPPRESSOR CONNECTION**
- 1 - 2
 - 2 - 3
 - 1 - 3

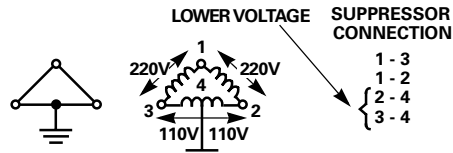
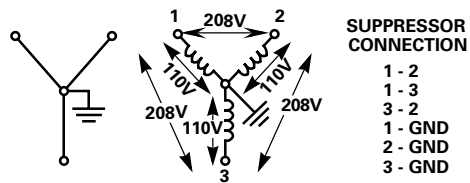

FIGURE 25D. 3 PHASE 220V

- SUPPRESSOR CONNECTION**
- 1 - 3
 - 1 - 2
 - 2 - 4
 - 3 - 4



If only 3 suppressor use 1-GND, 2-GND, 3-GND

FIGURE 25E. 3 PHASE 120V/208V, 4-WIRE

- SUPPRESSOR CONNECTION**
- 1 - 2
 - 1 - 3
 - 3 - 2
 - 1 - GND
 - 2 - GND
 - 3 - GND

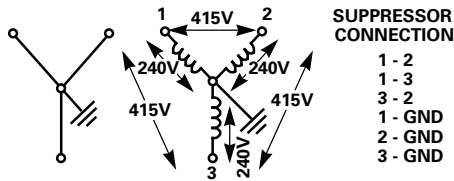

If only 3 suppressor use 1-GND, 2-GND, 3-GND

FIGURE 25F. 3 PHASE 240V/415V

- SUPPRESSOR CONNECTION**
- 1 - 2
 - 1 - 3
 - 3 - 2
 - 1 - GND
 - 2 - GND
 - 3 - GND

For higher voltages use same connections, but select varistors for the appropriate voltage rating.

Varistor Connection Examples (continued)

DC Application

DC applications require connection between plus and minus or plus and ground and minus and ground.

For example, if a transient towards ground exists on all 3 phases (common mode transients) only transient suppressors connected phase to ground would absorb energy. Transient suppressors connected phase to phase would not be effective.

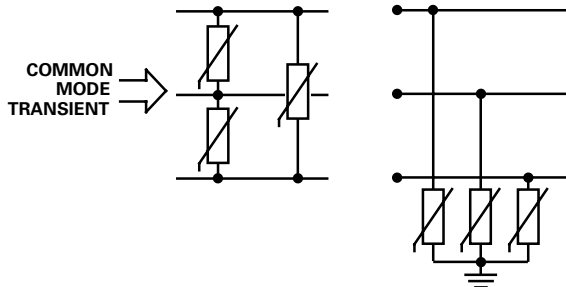

FIGURE 26A. INCORRECT **FIGURE 26B. CORRECT**
FIGURE 26. COMMON MODE TRANSIENT AND CORRECT SOLUTION

On the other hand if a differential mode of transient (phase to phase) exists then transient suppressors connected phase to phase would be the correct solution.

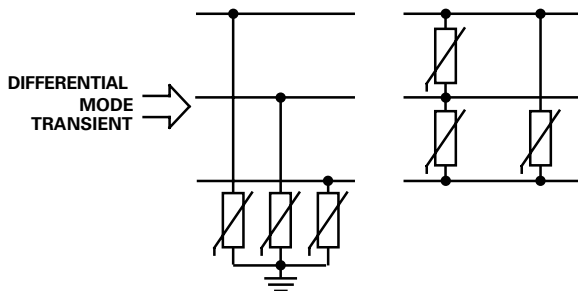

FIGURE 27A. INCORRECT **FIGURE 27B. CORRECT**
FIGURE 27. DIFFERENTIAL MODE TRANSIENT AND CORRECT SOLUTION

This is just a selection of some of the more important variations in connecting transient suppressors.

The logical approach is to connect the transient suppressor between the points of the potential difference created by the transient. The suppressor will then equalize or reduce these potentials to lower and harmless levels.

Varistor Selection Worksheet

Step 1. Determine the circuit's operating parameters.

(complete as much of the following information as possible).

1-a. Source and path of the transient

_____ Source _____ Path

1-b. Normal operating voltage of protected device

_____ (V_{AC}), or _____ (V)_{RMS} DC

1-c. Tolerance of normal operating voltage (1-b)

_____ (V) or _____ Unknown

1-d. Max. allowable voltage of protected device

_____ (V_{AC}) or _____ (V)_{RMS} DC

1-e. Maximum expected surge current and number of hits

(Specify 8x20μs waveform equivalent of surge current)

_____ (A) _____ (# of hits)

1-f. Maximum energy applied to device in surge event

_____ (Joules) (E=1.4xVxIxT)

1-g. Maximum power applied to device in surge event

_____ (W) (P=VxI)

1-h. Maximum allowable varistor capacitance (@1kHz; 0V_{DC} bias) (This is the maximum capacitance of the varistor device that will not impair the functionality of the circuit)

_____ (pF)

1-i. Required safety standards

(Name of standards required, such as UL, CSA, VDE, etc.)

Step 2. Calculate voltage value.

2-a. The required varistor voltage value should be equal to:

the operating voltage of the protected equipment or device*
+
the tolerance of the operating voltage.

If the tolerance is not known, multiply the operating voltage of protected equipment or device by 1.10 to 1.25 (i.e. 10–25% above operating voltage value).

If the operating voltage is in AC (V_{RMS}) convert to V_{DC}.
_____ Operating voltage AC (V) x 1.414 = _____
Operating voltage (V)_{RMS} DC

_____ Operating voltage of equipment or device (V_{DC})
+
_____ Tolerance (V) = _____
Required varistor voltage (V)

- or -

_____ Operating voltage of equipment or device (V_{DC})
x
(1.10 to 1.25) = _____ Required varistor voltage (V)

Step 3. Guidelines for Selecting a Varistor

If a response to one of the requirements below is "False," refer to appropriate corrective action notes (A-F) at bottom of list:

3-a. Varistor voltage value - Tolerance of varistor ≥ Required varistor voltage value (2-a) _____ **True** _____ **False (A)**

3-b. Varistor Maximum clamping voltage value < Maximum allowable voltage of protected equipment or device (1-d) (Max. current should be less than or equal to the current at which maximum clamping voltage is measured). _____ **True** _____ **False (B)**

3-c. Varistor maximum peak current value > Maximum expected surge current (1-e) _____ **True** _____ **False (C)**

Note: If surge current waveform is not 8 x 20μs, use Pulse Lifetime Ratings curves.

3-d. Varistor maximum energy rating > Maximum energy applied to system (1-f) _____ **True** _____ **False (D)**

3-e. Varistor maximum rated power > Maximum power applied to system (1-g) _____ **True** _____ **False (E)**

3-f. Varistor capacitance < Maximum allowable system capacitance (1-h) _____ **True** _____ **False (F)**

Corrective action notes:

- A. Select next varistor on the list (i.e. next varistor with increasing varistor voltage value) and then re-verify 3-a.
- B. Select previous varistor on the list (i.e. previous varistor with decreasing varistor voltage value) and then re-verify 3-b.
- C. Select next varistor diameter level and then re-verify 3-c. *
- D. Select next varistor diameter level and then re-verify 3-d. *
- E. Select next varistor diameter level and then re-verify 3-e. *
- F. Select lower varistor diameter level and then re-verify 3-c, 3-d, 3-e and 3-f. *

* If varistor voltage is below 82V, selecting an 82V ROV may be preferable over a higher diameter part.

Step 4. Verify the following system conditions.

4-a. Leakage current of the selected varistor is appropriate for the circuit _____ **True** _____ **False**

4-b. Verify the performance of the varistor under fault conditions _____ **Verified**

Users should Independently evaluate the suitability of, and test each MOV device in their application for safety and suitability with the end application.

Agency Standards

Littelfuse Varistors have been investigated and evaluated and are certified, recognized or otherwise approved with pertinent safety or standards organizations. Following are descriptions of some of the applicable standards.

Underwriters Laboratories (UL)

UL writes "Standards" to which products are investigated. Upon completion of the tests, a "Listing" or "Recognition" to the standard with conditions of acceptability is given under a unique file number. All of Littelfuse applicable Varistors are in the "Recognized Components" category to one or more of the following standards:

- **UL1449** Transient Voltage Suppressors.
- **UL497B** Protectors for Data and Communication and Fire Alarm Circuits.

(Note that the terms "Approved" or "Certified" are not correct in referring to devices listed or recognized by UL.)

VDE (Verband Deutscher Electrotechniker)

Based in Germany, this is the Association of German Engineers who develop specific safety standards and test requirements. VDE tests and certifies devices or products, assigning a license number. Littelfuse Radial Varistors are currently certified under license number 104846-E having successfully met CECC standard 42 201-006 (issue 1/1996).

CECC (CENELEC Electronic Components Committee)

Based in Brussels, CENELEC is the "European Committee for Electrotechnical Standardization" which provides harmonized standards for the European Community based upon IEC and ISO publications. All Littelfuse Radial Varistor Series are approved to Specification 42201-006.

CSA (Canadian Standards Association)

Based in Canada, this regulatory agency writes standards to which it conducts product safety tests. Upon successful completion, a file number is established, the product is "Certified" and may display the CSA logo as indication. Specific Littelfuse Varistors have been tested to CSA Standard number 22.2, No.1-94. Littelfuse file number is 91788.

Electrostatic Discharge (ESD) Standards

Several industry standards and specifications exist that

are used to qualify and quantify ESD events. Since many circuits or systems must demonstrate immunity to ESD, these standards are often incorporated in the testing of ESD capability. Of particular concern is the immunity level for semiconductors. The "standards" include Human Body Model (HBM) to MIL-STD-883, Machine Model (MM) such as EIAJ IC121, and Charged Device Model (CDM) such as US ESD DS 5.3. The Human Body Model, Machine Model and Charged Device Model primarily relate to manufacturing and testing process of an IC.

One of the most severe is IEC 61000-4-2 from the International Electrotechnical Commission (IEC) and referenced in the EMC directive. Level 4 of this test method is the highest level, subjecting the device under test to 8kV contact discharge method (preferred) and/or 15kV air discharge. Each Littelfuse technology is designed for this level. Recommended Littelfuse devices for these applications include Silicon Protection Arrays, PulseGuard[®] ESD Suppressors, and ML, MLE, MHS or MLN series Multilayer Varistors.

The designer should be aware of the ESD ratings of the semiconductors used in the circuit. For example, semiconductor manufacturers that rate their devices to MIL-STD-883 to 2kV may not pass 2kV when subjected to the more difficult IEC test method (150pF / 330Ω instead of 100pF / 1500Ω). Additionally, even if semiconductors do meet some level of ESD immunity to IEC standards, that does not imply that additional ESD suppression is not required. Real world ESD transients can exceed the peak currents and voltages as defined by the standards and can have much faster rise times.

IEC 61000-4-2 consists of four test severity levels of ESD immunity using both a Contact Discharge and Air Discharge test method. The EUT or DUT may be subjected to increasing levels of severity until failure. Or, a particular level of immunity may be prescribed for EM compatibility of an end product.

For more information about the IEC 61000-4-2 test method, see Application Note AN9734, "IEC Electromagnetic Compatibility Standards for Industrial Process Measurement and Control Equipment."

Agency Standards (continued)

AGENCY AND SPECIFICATION NUMBER						
SERIES	UL UL1449	UL UL497B	CSA 22.2-1	VDE IEC 61051-1 and 61051-2	IEC Annex Q	DSSC MIL, QPL
Surface Mount MOVs:						
CH	X					
SM7	Note 1					
SM20	Note 1					
Radial Lead MOVs:						
TMOV® 14mm and 20mm	X				Note 1	
TMOV® 25mm	X					
UltraMOV™	X		X	X	Note 1	
25S UltraMOV™	X					
C-III	X		X	X	Note 1	
LA	X	X	X	X	Note 1	
ZA	Note 1	X		Note 1	Note 1	
Industrial / High Energy MOVs:						
BA	X					
BB						
DA/DB	X					
HA, HC	X		X			
TMOV® 34mm	X					
HB, HF, HG, DHB	X		X			
CA60 Disk						
Special / Application Specific MOVs:						
MA						
RA	Note 1	X	Note 1			
HI REL, QPL Parts						X

NOTES:

- 1) Applies to certain models only, see specific product Data Sheet for details.
- Not all types within each series are applicable for recognition.
- Not all Littelfuse Varistors products require safety listing due to their low operating voltage and intended applications. These includes ML, MLN, MLE, MHS surface mount (leadless) devices.
- The information provided is accurate at the time of printing. Changes can occur based upon new products offered by Littelfuse, revision of an existing standard, or introduction of a new standard or agency requirement. Contact Littelfuse Sales for latest information.

Legal Disclaimers

Liability

Littelfuse, Inc. its affiliates, agents, and employees, and all persons acting on its or their behalf (collectively, "Littelfuse"), disclaim any and all liability for any errors, inaccuracies or incompleteness contained here or in any other disclosure relating to any product. Littelfuse disclaims any and all liability arising out of the use or application of any product described herein or of any information provided herein to the maximum extent permitted by law. The product specifications do not expand or otherwise modify Littelfuse terms and conditions of purchase, including but not limited to the warranty expressed therein, which apply to these products.

Right to Make Changes

Littelfuse reserves the right to make any and all changes to the products described herein without notice.

Not Intended for Use in Life Support or Life Saving Applications

The products shown herein are not designed for use in life sustaining or life saving applications unless otherwise expressly indicated. Customers using or selling Littelfuse products not expressly indicated for use in such applications do so entirely at their own risk and agree to fully indemnify Littelfuse for any damages arising or resulting from such use or sale. Please contact authorized Littelfuse personnel to obtain terms and conditions regarding products designed for such applications.

Intellectual Property

No license, express or implied, by estoppel or otherwise, to any intellectual property rights is granted by this document or by any conduct of Littelfuse. Product names and markings noted herein may be registered trademarks of their respective owners. Littelfuse makes no representations or warranties of non-infringement or misappropriation of any third party intellectual property rights unless specifically provided for herein.

Disclaimer

Specifications, descriptions and data contained in this document are believed to be accurate. However, users should independently evaluate each product for the particular application. Littelfuse reserves the right to change any information contained herein without notice and may, at its sole discretion, change the design, manufacture or construction of any product. Visit www.littelfuse.com for the most up-to-date information. Littelfuse's only obligations for any of its products are specified in its Standard Terms and Conditions and Littelfuse shall not be liable for any indirect, consequential or incidental damages from any sale or use of any of its products.

MHS Varistor Series

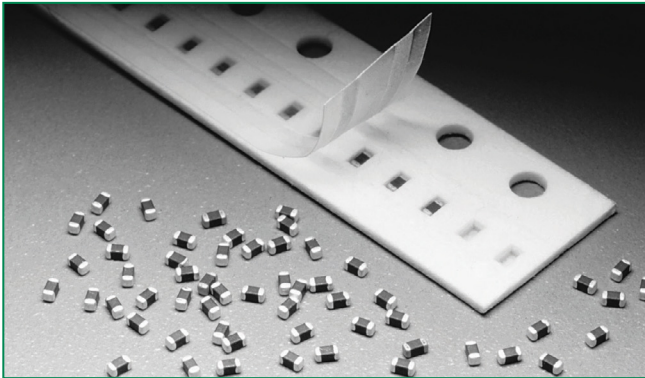

Size Table

Metric	EIA
1005	0402
1608	0603

Additional Information



Datasheet



Resources



Samples

Applications

- Data, Diagnostic I/O Ports
- Universal Serial Bus (USB)
- Video & Audio Ports
- Portable/Hand-Held Products
- Mobile Communications
- Computer/DSP Products
- Industrial Instruments Including Medical

Description

The Multilayer High-Speed MHS Series is a very-low capacitance extension to the Littelfuse ML family of transient voltage surge suppression devices available in an 0402 and 0603-size surface mount chip.

The MHS Series provides protection from ESD and EFT in high-speed data line and other high frequency applications. The low capacitance of the MHS Series permits usage in analog or digital circuits where it will not attenuate or distort the desired signal or data.

Their small size is ideal for high-density printed circuit boards, being typically applied to protect intergrated circuits and other sensitive components. They are particularly well suited to suppress ESD events including those specified in IEC 61000-4-2 or other standards used for Electromagnetic Compliance (EMC) testing.

The MHS Series is manufactured from semiconducting ceramics and is supplied in a leadless, surface mount package. The MHS Series is also compatible with modern reflow and wave soldering processes.

Littelfuse Inc. manufactures other multilayer varistor series products, see the ML, MLE, MLN and AUML Series data sheets.

Features

- Halogen-Free and RoHS compliant
- 3pF, 12pF, and 22pF capacitance versions suitable for high-speed data rate lines
- ESD rated to IEC
- 61000-4-2 (Level 4)
- EFT/B rated to IEC 61000-4-4 (Level 4)
- Low leakage currents
- -55°C to +125°C operating temp. range
- Inherently bi-directional

Absolute Maximum Ratings

• For ratings of individual members of a series, see device ratings and specifications table.

Continuous	MHS Series	Units
Steady State Applied Voltage:		
DC Voltage Range (V_{MDC}) :	V0402/0603MHS03	≤ 42 V
	V0402/0603MHS12	≤ 18 V
	V0402/0603MHS22	≤ 09 V
Operating Ambient Temperature Range (T_A)	-55 to +125	°C
Storage Temperature Range (T_{STG})	-55 to +150	°C

Device Ratings and Specifications

Part Number	Performance Specifications (25 °C)							
	Maximum Clamping Voltage At 1A (8X20 μ s)	Maximum ESD Clamp Voltage (Note 1)		Typical Leakage Current at Specified DC Voltage		Typical Capacitance at 1MHz (1V p-p)		Typical Inductance (from Impedance Analysis)
		8kV Contact (Note 2)	15kV AIR (Note 3)	3.5V	5.5V	C (Note 4)		
	(V _c)	Clamp (V)	Clamp (V)	P (μ A)	I _L (μ A)	MIN (pF)	MAX (pF)	L (nH)
V0402MHS03N (Note 5)	135	<300	<400	0.5	1.00	2	5	<1.0
V0402MHS03F (Note 7)	135	<300	<400	0.5	1.00	2	5	<1.0
V0603MHS03N (Note 5)	135	<300	<400	0.5	1.00	1	6	<1.0
V0603MHS03F (Note 7)	135	<300	<400	0.5	1.00	1	6	<1.0
V0402MHS12N (Note 5)	55	<125	<160	0.5	1.00	8	16	<1.0
V0402MHS12F (Note 7)	55	<125	<160	0.5	1.00	8	16	<1.0
V0603MHS12N (Note 5)	55	<125	<160	0.5	1.00	8	16	<1.0
V0603MHS12F (Note 7)	55	<125	<160	0.5	1.00	8	16	<1.0
V0402MHS22N (Note 5)	30	<125	<160	0.5	1.00	15	29	<1.0
V0402MHS22F (Note 7)	30	<125	<160	0.5	1.00	15	29	<1.0
V0603MHS22N (Note 5)	30	<65	<100	0.5	1.00	15	29	<1.0
V0603MHS22F (Note 7)	30	<65	<100	0.5	1.00	15	29	<1.0

NOTES:

1. Tested to IEC-61000-4-2 Human Body Model (HBM) discharge test circuit.
2. Direct discharge to device terminals (IEC preferred test method).
3. Corona discharge through air (represents actual ESD event).
4. Capacitance may be customized, contact your Littelfuse Sales Representative.
5. V0402MHSxxx (0402 size devices) available as "R" packaging option only. Example: V0402MHS03NR. See Packaging and Tape and Reel sections (last page) for additional information.
6. The typical capacitance rating is discrete component test result.
7. Items are lead free and antimony free, available as "R" packing option only.

Peak Current and Energy Derating Curve

For applications exceeding 125°C ambient temperature, the peak surge current and energy ratings must be reduced as shown below.

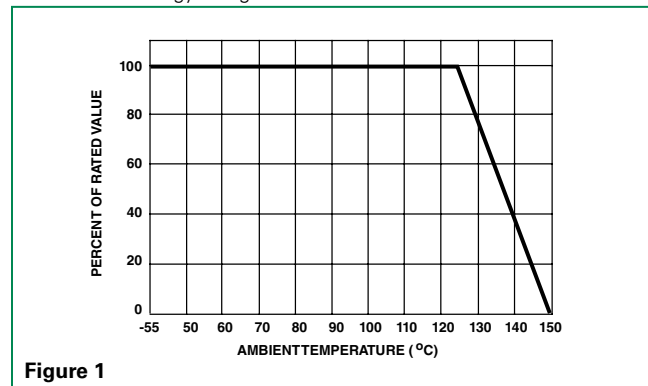

Standby Current at Normalized Varistor Voltage and Temperature

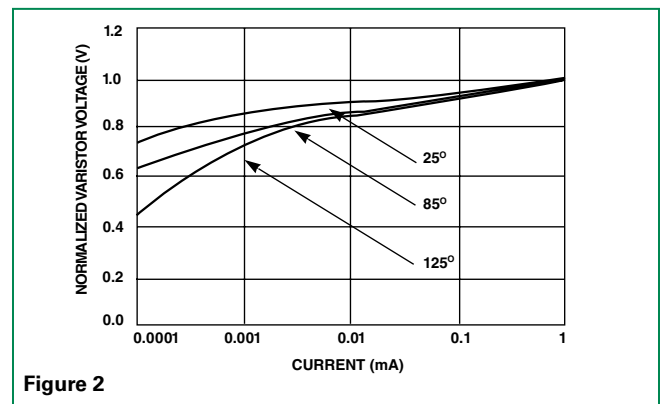

Disclaimer Notice - Information furnished is believed to be accurate and reliable. However, users should independently evaluate the suitability of and test each product selected for their own applications. Littelfuse products are not designed for, and may not be used in, all applications. Read complete Disclaimer Notice at www.littelfuse.com/disclaimer-electronics.

Nominal Voltage Stability to Multiple ESD Impulses (8kV Contact Discharges per IEC 61000-4-2)

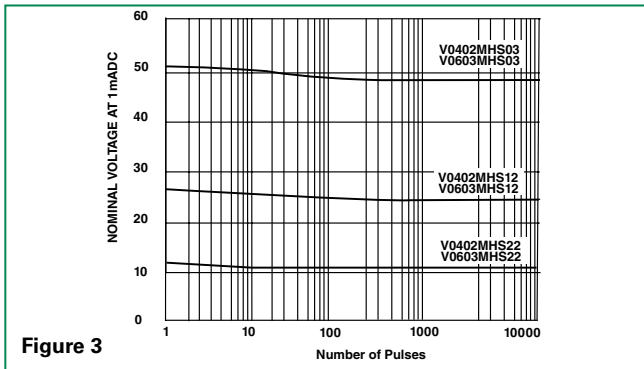

Figure 3

Insertion Loss (S21) Characteristics

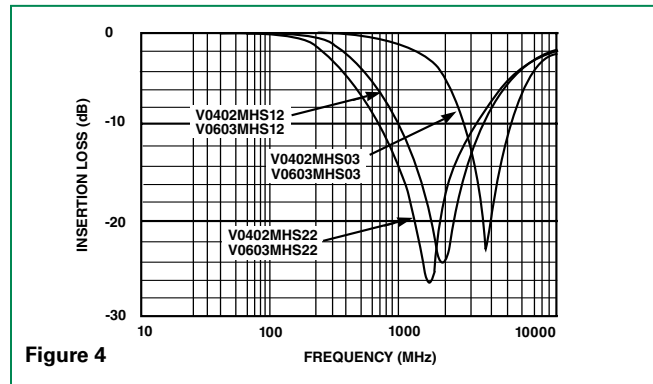

Figure 4

Device Characteristics

At low current levels, the V-I curve of the multilayer transient voltage suppressor approaches a linear (ohmic) relationship and shows a temperature dependent effect. At or below the maximum working voltage, the suppressor is in a high resistance model (approaching $10^6 \Omega$ at its maximum rated working voltage). Leakage currents at maximum rated voltage are below $100 \mu A$, typically $25 \mu A$; for 0402 size below $20 \mu A$, typically $5 \mu A$.

Speed of Response

The Multilayer Suppressor is a leadless device. Its response time is not limited by the parasitic lead inductances found in other surface mount packages. The response time of the ZnO dielectric material is less than 1ns and the MLE can clamp very fast dV/dT events such as ESD. Additionally, in "real world" applications, the associated circuit wiring is often the greatest factor effecting speed of response. Therefore, transient suppressor placement within a circuit can be considered important in certain instances.

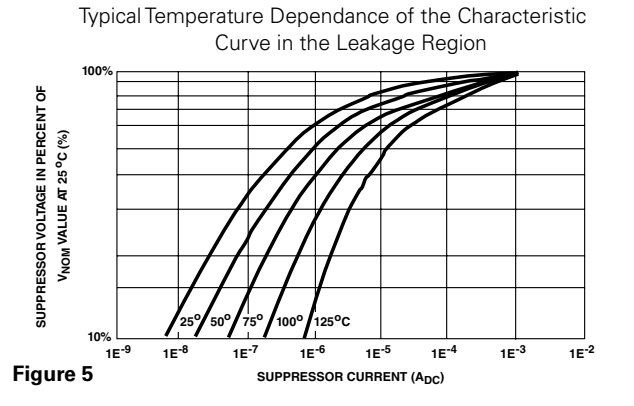

Figure 5

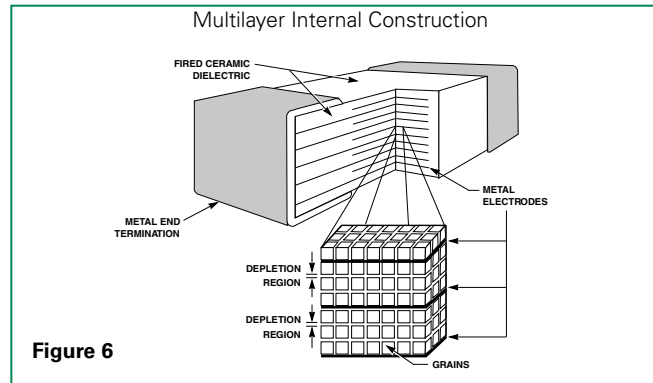

Figure 6

Lead (Pb) Soldering Recommendations

The principal techniques used for the soldering of components in surface mount technology are IR Re-flow and Wave soldering. Typical profiles are shown on the right.

Reflow Solder Profile

The recommended solder for the MHS suppressor is a 62/36/2 (Sn/Pb/Ag), 60/40 (Sn/Pb) or 63/37 (Sn/Pb). Littelfuse also recommends an RMA solder flux.

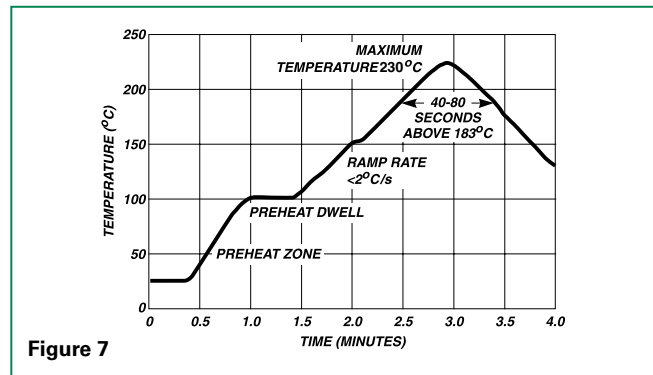

Figure 7

Wave soldering is the most strenuous of the processes. To avoid the possibility of generating stresses due to thermal shock, a preheat stage in the soldering process is recommended, and the peak temperature of the solder process should be rigidly controlled.

Lead-free (Pb-free) Soldering Recommendations

When using a reflow process, care should be taken to ensure that the MHS chip is not subjected to a thermal gradient steeper than 4 degrees per second; the ideal gradient being 2 degrees per second. During the soldering process, preheating to within 100 degrees of the solder's peak temperature is essential to minimize thermal shock.

Once the soldering process has been completed, it is still necessary to ensure that any further thermal shocks are avoided. One possible cause of thermal shock is hot printed circuit boards being removed from the solder process and subjected to cleaning solvents at room temperature. The boards must be allowed to cool gradually to less than 50°C before cleaning.

Littelfuse offers the Nickel Barrier Termination finish for the optimum Lead-free solder performance.

The preferred solder is 96.5/3.0/0.5 (SnAgCu) with an RMA flux, but there is a wide selection of pastes and fluxes available with which the Nickel Barrier parts should be compatible.

The reflow profile must be constrained by the maximums in the Lead-free Reflow Profile. For Lead-free wave soldering, the Wave Solder Profile still applies.

Note: the Lead-free paste, flux and profile were used for evaluation purposes by Littelfuse, based upon industry standards and practices. There are multiple choices of all three available, it is advised that the customer explores the optimum combination for their process as processes vary considerably from site to site.

Wave Solder Profile

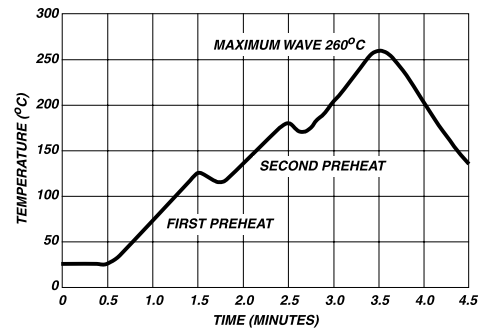

Figure 8

Lead-free Re-flow Profile

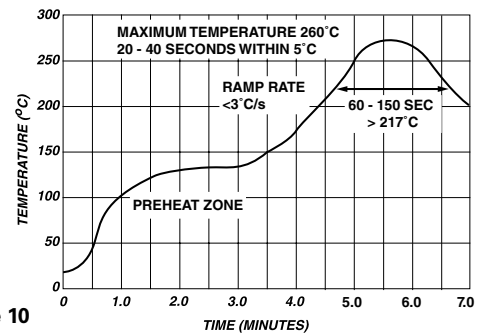
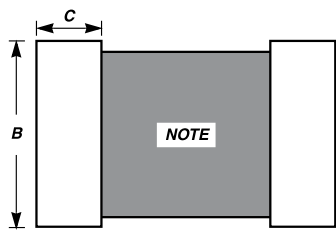

Figure 10

Product Dimensions (mm)

PAD LAYOUT DIMENSIONS



Note: Avoid metal runs in this area, parts are not recommended for use in applications using Silver (Ag) epoxy paste.

CHIP LAYOUT DIMENSIONS

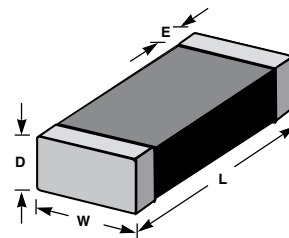

Dimension	0402 Size		0603 Size	
	IN	MM	IN	MM
A	0.067	1.700	0.100	2.540
B	0.020	0.510	0.030	0.760
C	0.024	0.610	0.035	0.890
D (max.)	0.024	0.600	0.040	1.000
E	0.01 +/- 0.006	0.25 +/- 0.15	0.015 +/- 0.008	0.4 +/- 0.2
L	0.039 +/- 0.004	1.00 +/- 0.10	0.063 +/- 0.006	1.6 +/- 0.15
W	0.020 +/- 0.004	0.50 +/- 0.10	0.032 +/- 0.006	0.8 +/- 0.15

Part Numbering System

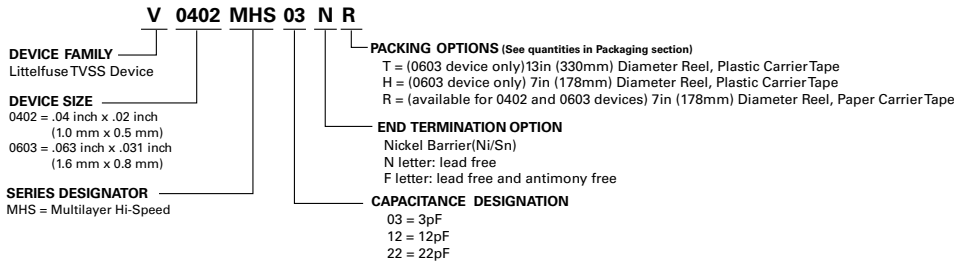

Packaging*

Device Size	Quantity		
	13 Inch Reel ("T" Option)	7 Inch Reel ("H" Option)	7 Inch Reel ("R" Option)
0603	10,000	2,500	4,000
0402	not available	not available	10,000

*(Packaging) It is recommended that parts be kept in the sealed bag provided and that parts be used as soon as possible when removed from bags.

Tape and Reel Specifications

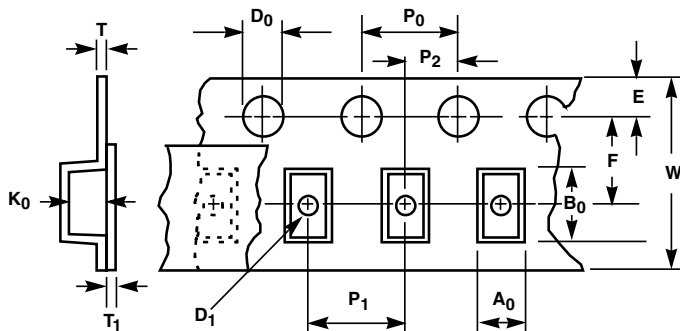

Symbol	Description	Dimensions in Millimeters	
		0402 Size	0603 Size
A_0	Width of Cavity	Dependent on Chip Size to Minimize Rotation.	
B_0	Length of Cavity	Dependent on Chip Size to Minimize Rotation.	
K_0	Depth of Cavity	Dependent on Chip Size to Minimize Rotation.	
W	Width of Tape	8 +/- 0.2	8 +/- 0.3
F	Distance Between Drive Hole Centers and Cavity Centers	3.5 +/- 0.05	3.5 +/- 0.05
E	Distance Between Drive Hole Centers and Tape Edge	1.75 +/- 0.1	1.75 +/- 0.1
P_1	Distance Between Cavity Centers	2 +/- 0.05	4 +/- 0.1
P_2	Axial Drive Distance Between Drive Hole Centers & Cavity Centers	2 +/- 0.1	2 +/- 0.1
P_0	Axial Drive Distance Between Drive Hole Centers	4 +/- 0.1	4 +/- 0.1
D_0	Drive Hole Diameter	1.55 +/- 0.05	1.55 +/- 0.05
D_1	Diameter of Cavity Piercing	N/A	1.05 +/- 0.05
T_1	Top Tape Thickness	0.1 Max	0.1 Max
T	Nominal Carrier Tape Thickness	1.1	1.1

- Notes:
- Conforms to EIA-481-1, Revision A
 - Can be supplied to IEC publication 286-3

MLE Varistor Series

RoHS HF



Size Table

Metric	EIA
1005	0402
1608	0603
2012	0805
3216	1206

Applications

- Protection of components and circuits sensitive to ESD Transients occurring on power supplies, control and signal lines
- Suppression of ESD events such as specified in IEC-61000-4-2 or MIL-STD-883 Method-3015.7, for electromagnetic compliance (EMC)
- Used in mobile communications, computer/EDP products, medical products, hand held/portable devices, industrial equipment, including diagnostic port protection and I/O interfaces

Description

The MLE Series family of transient voltage suppression devices are based on the Littelfuse multilayer fabrication technology. These components are designed to suppress ESD events, including those specified in IEC 61000-4-2 or other standards used for Electromagnetic Compliance testing. The MLE Series is typically applied to protect integrated circuits and other components at the circuit board level operating at $18V_{DC}$ or less.

The fabrication method and materials of these devices result in capacitance characteristics suitable for high frequency attenuation/low-pass filter circuit functions, thereby providing suppression and filtering in a single device.

The MLE Series is manufactured from semiconducting ceramics and is supplied in a leadless, surface mount package. The MLE Series is compatible with modern reflow and wave soldering procedures.

Littelfuse Inc. manufactures other Multilayer Series products. See the ML Series data sheet for higher energy/peak current transient applications. See the AUML Series for automotive applications and the MLN Quad Array. For high-speed applications see the MHS Series.

Features

- Halogen-Free and RoHS Compliant
- Rated for ESD (IEC-61000-4-2)
- Characterized for impedance and capacitance
- -55°C to $+125^{\circ}\text{C}$
- operating temp. range
- Leadless 0402, 0603, 0805, and 1206 sizes
- Operating voltages up to $18V_{M(DC)}$
- Multilayer ceramic construction technology

Additional Information



Datasheet



Resources



Samples

Absolute Maximum Ratings

• For ratings of individual members of a series, see device ratings and specifications table.

Continuous	MLE Series	Units
Steady State Applied Voltage:		
DC Voltage Range ($V_{M(DC)}$)	≤ 18	V
Operating Ambient Temperature Range (T_A)	-55 to +125	$^{\circ}\text{C}$
Storage Temperature Range (T_{STG})	-55 to +150	C

Device Ratings and Specifications

Part Number	Max Continuous Working Voltage -55°C to 125°C	Performance Specifications (25°C)					
		Nominal Voltage		Maximum Clamping Voltage at Specified Current (8/20 μ s)	Maximum ESD Clamp Voltage (Note 2)		Typical Capacitance at 1MHz
		(Note 1) V _{M(DC)}	V _{NOM} at 1mA DC		V _C	8kV Contact (Note 3)	
(V)	MIN (V)	MAX (V)	(V)	(V)	Clamp (V)	(pF)	
V18MLE0402N	18	22	28	50 at 1A	<125	<110	<55
V18MLE0402F (Note 8)	18	22	28	50 at 1A	<125	<110	<55
V18MLE0603N	18	22	28	50 at 1A	<75	<110	<125
V18MLE0603F (Note 8)	18	22	28	50 at 1A	<75	<110	<125
V18MLE0603LN	18	22	28	50 at 1A	<100	<140	<100
V18MLE0805N	18	22	28	50 at 1A	<70	<75	<500
V18MLE0805LN	18	22	28	50 at 1A	<75	<135	<290
V18MLE1206N	18	22	28	50 at 1A	<65	<65	<1700

- NOTES:
- For applications of 18V_{DC} or less. Higher voltages available, contact your Littelfuse Sales Representative.
 - Tested with IEC-61000-4-2 Human Body Model (HBM) discharge test circuit.
 - Direct discharge to device terminals (IEC preferred test method).
 - Corona discharge through air (represents actual ESD event).
 - Capacitance may be customized, contact your Littelfuse Sales Representative.
 - Leakage current ratings are at 18V_{DC} and 25 μ A maximum.
 - The typical capacitance rating is the discrete component test result.
 - Items are lead free, and available as "R" packing option only.

Peak Current and Energy Derating Curve

For applications exceeding 125°C ambient temperature, the peak surge current and energy ratings must be reduced as shown below.

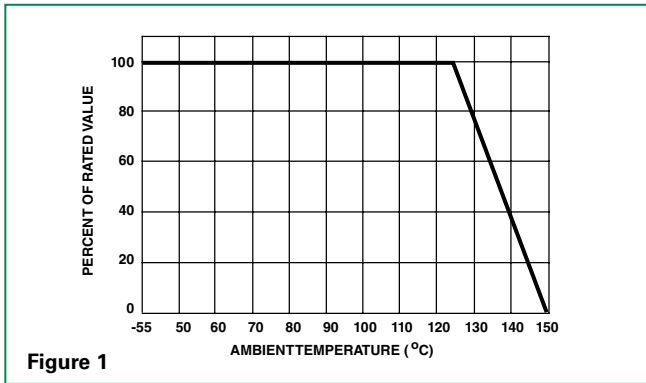

Figure 1

Standby Current at Normalized Varistor Voltage and Temperature

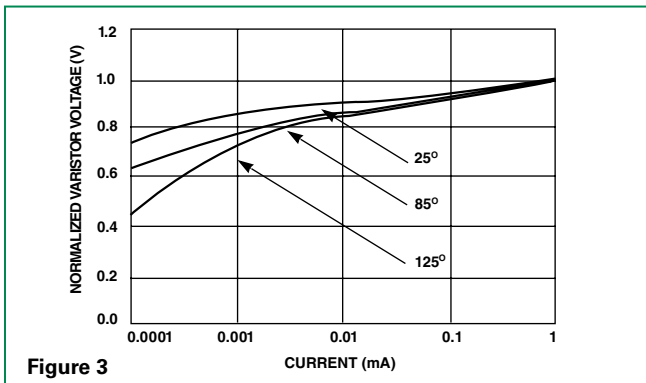

Figure 3

Nominal Voltage Stability to Multiple ESD Impulses (8kV Contact Discharges per IEC 61000-4-2)

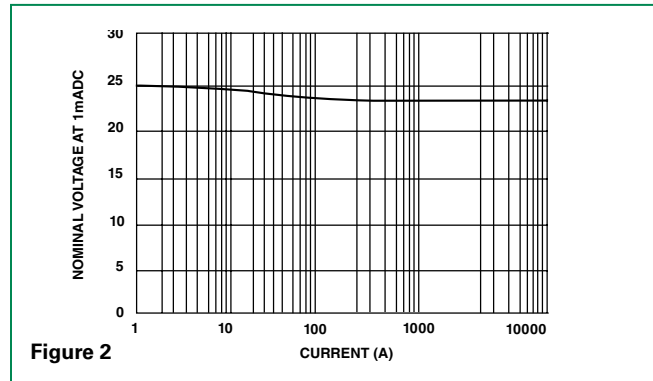

Figure 2

Impedance (Z) vs Frequency Typical Characteristic

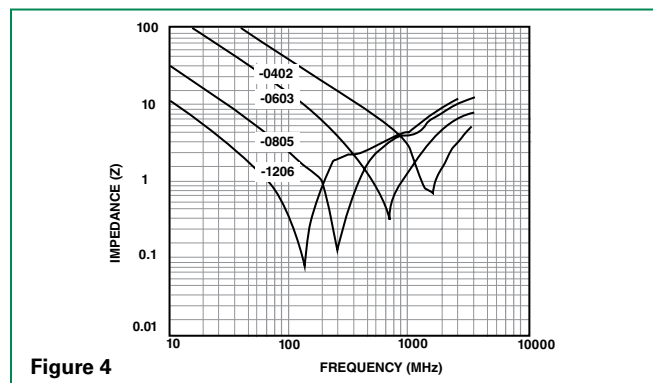

Figure 4

Device Characteristics

At low current levels, the V-I curve of the multilayer transient voltage suppressor approaches a linear (ohmic) relationship and shows a temperature dependent effect. At or below the maximum working voltage, the suppressor is in a high resistance model (approaching $10^9\Omega$ at its maximum rated working voltage). Leakage currents at maximum rated voltage are below $100\mu A$, typically $25\mu A$; for 0402 size below $20\mu A$, typically $5\mu A$.

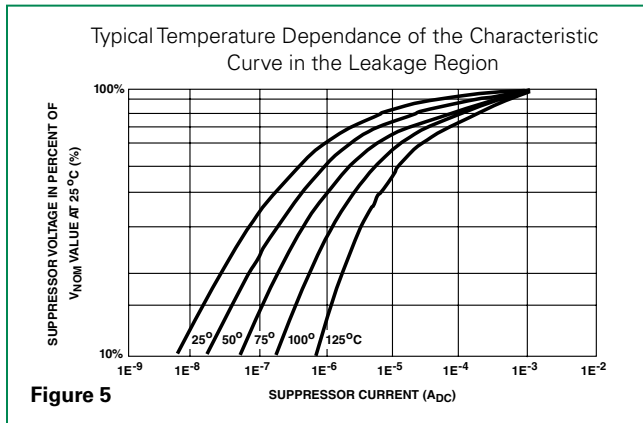

Figure 5

Speed of Response

The Multilayer Suppressor is a leadless device. Its response time is not limited by the parasitic lead inductances found in other surface mount packages. The response time of the $Z_{N}O$ dielectric material is less than 1ns and the MLE can clamp very fast dV/dT events such as ESD. Additionally, in "real world" applications, the associated circuit wiring is often the greatest factor effecting speed of response. Therefore, transient suppressor placement within a circuit can be considered important in certain instances.

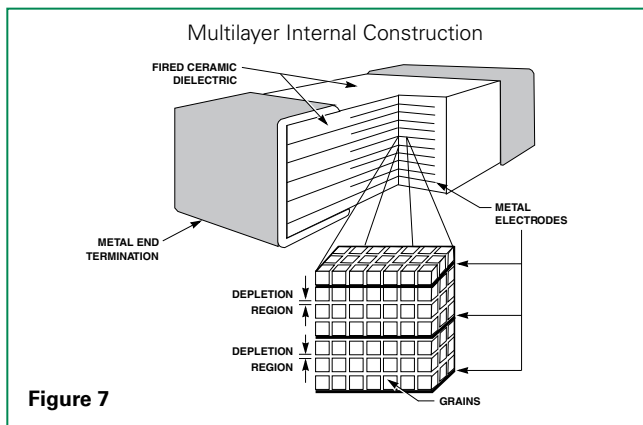

Figure 7

Clamping Voltage Over Temperature (V_c at 10A)

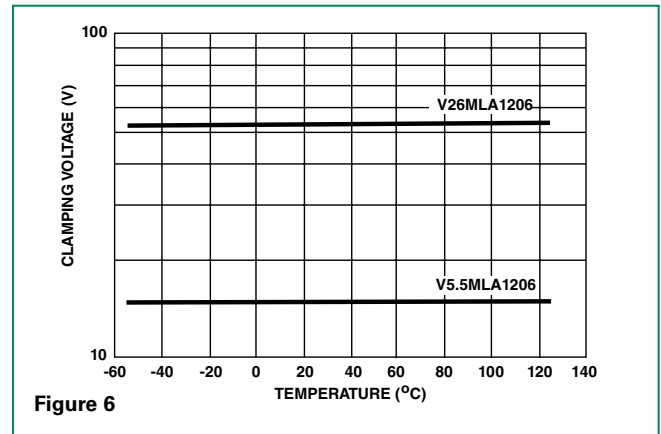

Figure 6

Energy Absorption/Peak Current Capability

Energy dissipated within the MLE is calculated by multiplying the clamping voltage, transient current and transient duration. An important advantage of the multilayer is its interdigitated electrode construction within the mass of dielectric material. This results in excellent current distribution and the peak temperature per energy absorbed is very low. The matrix of semiconducting grains combine to absorb and distribute transient energy (heat) (see Speed of Response). This dramatically reduces peak temperature; thermal stresses and enhances device reliability.

As a measure of the device capability in energy and peak current handling, the V26MLA1206A part was tested with multiple pulses at its peak current rating (3A, 8/20 μs). At the end of the test, 10,000 pulses later, the device voltage characteristics are still well within specification.

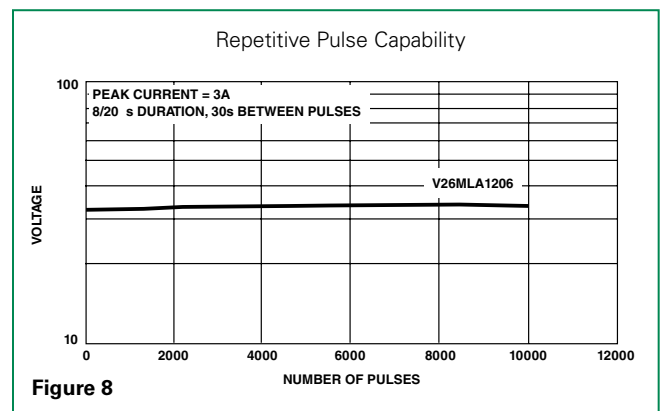

Figure 8

Lead (Pb) Soldering Recommendations

The principal techniques used for the soldering of components in surface mount technology are IR Re-flow and Wave soldering. Typical profiles are shown on the right.

The recommended solder for the MLE suppressor is a 62/36/2 (Sn/Pb/Ag), 60/40 (Sn/Pb) or 63/37 (Sn/Pb). Littelfuse also recommends an RMA solder flux.

Wave soldering is the most strenuous of the processes. To avoid the possibility of generating stresses due to thermal shock, a preheat stage in the soldering process is recommended, and the peak temperature of the solder process should be rigidly controlled.

When using a reflow process, care should be taken to ensure that the MLE chip is not subjected to a thermal gradient steeper than 4 degrees per second; the ideal gradient being 2 degrees per second. During the soldering process, preheating to within 100 degrees of the solder's peak temperature is essential to minimize thermal shock.

Once the soldering process has been completed, it is still necessary to ensure that any further thermal shocks are avoided. One possible cause of thermal shock is hot printed circuit boards being removed from the solder process and subjected to cleaning solvents at room temperature. The boards must be allowed to cool gradually to less than 50°C before cleaning.

Reflow Solder Profile

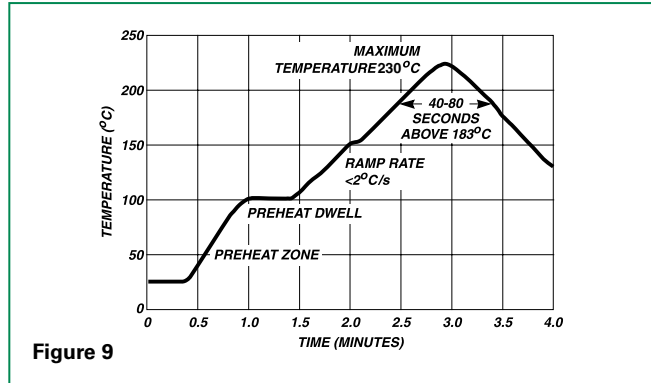

Wave Solder Profile

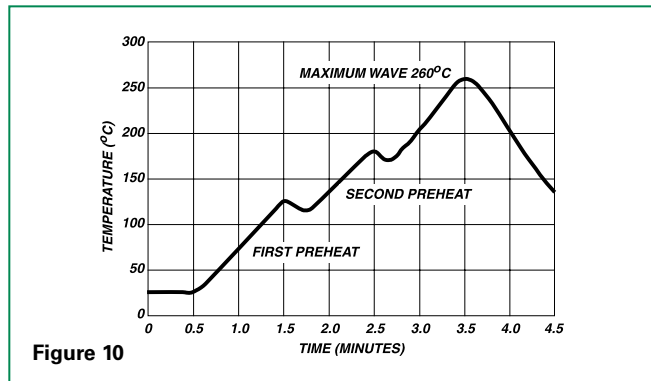

Lead-free (Pb-free) Soldering Recommendations

Littelfuse offers the Nickel Barrier Termination finish for the optimum Lead-free solder performance.

The preferred solder is 96.5/3.0/0.5 (SnAgCu) with an RMA flux, but there is a wide selection of pastes and fluxes available with which the Nickel Barrier parts should be compatible.

The reflow profile must be constrained by the maximums in the Lead-free Reflow Profile. For Lead-free Wave soldering, the Wave Solder Profile still applies.

Note: the Lead-free paste, flux and profile were used for evaluation purposes by Littelfuse, based upon industry standards and practices. There are multiple choices of all three available, it is advised that the customer explores the optimum combination for their process as processes vary considerably from site to site.

Lead-free Re-flow Profile

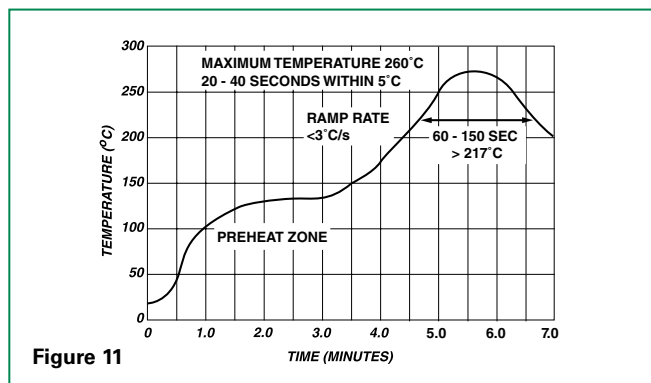

Product Dimensions (mm)

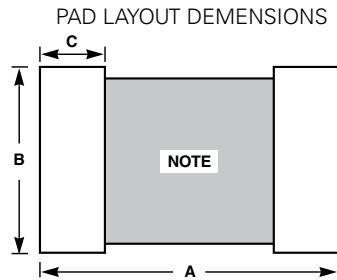

NOTE: Avoid metal runs in this area.

Note: Avoid metal runs in this area, parts are not recommended for use in applications using Silver (Ag) epoxy paste.

CHIP LAYOUT DIMENSIONS

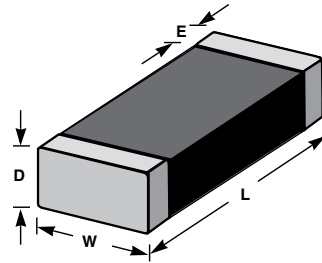

Dimension	1206 Size		0805 Size		0603 Size		0402 Size	
	IN	MM	IN	MM	IN	MM	IN	MM
A	0.160	4.06	0.120	3.05	0.100	2.54	0.067	1.70
B	0.065	1.65	0.050	1.27	0.030	0.76	0.020	0.51
C	0.040	1.02	0.040	1.02	0.035	0.89	0.024	0.61
D (max.)	0.071	1.80	0.043	1.10	0.040	1.00	0.024	0.60
E	0.02 +/- 0.01	0.50 +/- 0.25	0.02 +/- 0.01	0.50 +/- 0.25	0.015 +/- 0.008	0.4 +/- 0.2	0.010 +/- 0.006	0.25 +/- 0.15
L	0.125 +/- 0.012	3.20 +/- 0.03	0.079 +/- 0.008	2.01 +/- 0.2	0.063 +/- 0.006	1.6 +/- 0.15	0.039 +/- 0.004	1.0 +/- 0.1
W	0.06 +/- 0.011	1.60 +/- 0.28	0.049 +/- 0.008	1.25 +/- 0.2	0.032 +/- 0.006	0.8 +/- 0.15	0.020 +/- 0.004	0.5 +/- 0.1

Part Numbering System

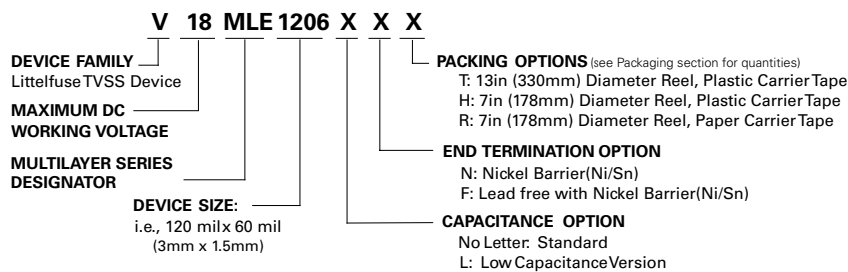

Packaging*

Device Size	Quantity			
	13" Inch Reel ('T' Option)	7" Inch Reel ('H' Option)	7" Inch Reel ('R' Option)	Bulk Pack ('A' Option)
1206	10,000	2,500	N/A	2500
0805	10,000	2,500	N/A	2500
0603	10,000	2,500	4,000	2500
0402	N/A	N/A	10,000	N/A

*(Packaging) It is recommended that parts be kept in the sealed bag provided and that parts be used as soon as possible when removed from bags.

Tape and Reel Specifications

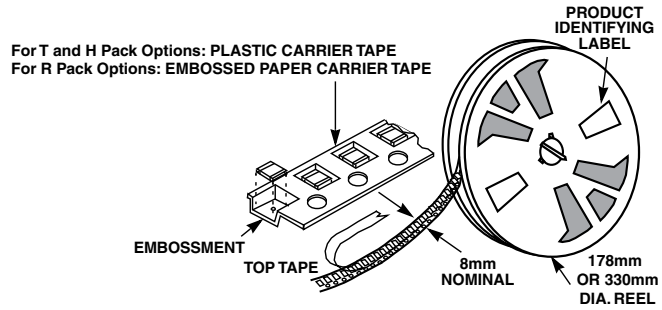
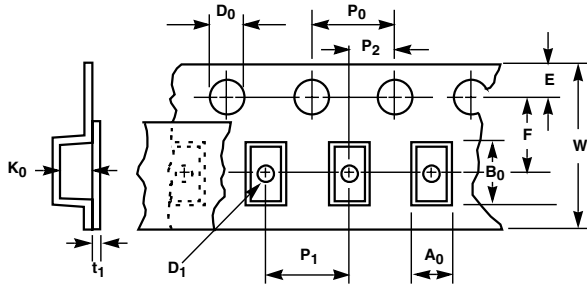

Symbol	Description	Dimensions in Millimeters	
		0402 Size	0603, 0805 & 1206 Sizes
A₀	Width of Cavity	Dependent on Chip Size to Minimize Rotation.	
B₀	Length of Cavity	Dependent on Chip Size to Minimize Rotation.	
K₀	Depth of Cavity	Dependent on Chip Size to Minimize Rotation.	
W	Width of Tape	8 +/- 0.2	8 +/- 0.3
F	Distance Between Drive Hole Centers and Cavity Centers	3.5 +/- 0.05	3.5 +/- 0.05
E	Distance Between Drive Hole Centers and Tape Edge	1.75 +/- 0.1	1.75 +/- 0.1
P₁	Distance Between Cavity Centers	2 +/- 0.05	4 +/- 0.1
P₂	Axial Drive Distance Between Drive Hole Centers & Cavity Centers	2 +/- 0.1	2 +/- 0.1
P₀	Axial Drive Distance Between Drive Hole Centers	4 +/- 0.1	4 +/- 0.1
D₀	Drive Hole Diameter	1.55 +/- 0.05	1.55 +/- 0.05
D₁	Diameter of Cavity Piercing	N/A	1.05 +/- 0.05
T₁	Top Tape Thickness	0.1 Max	0.1 Max

- Notes :
- Conforms to EIA-481-1, Revision A
 - Can be supplied to IEC publication 286-3

Disclaimer Notice - Information furnished is believed to be accurate and reliable. However, users should independently evaluate the suitability of and test each product selected for their own applications. Littelfuse products are not designed for, and may not be used in, all applications. Read complete Disclaimer Notice at www.littelfuse.com/disclaimer-electronics.

0201 MLA Varistor Series

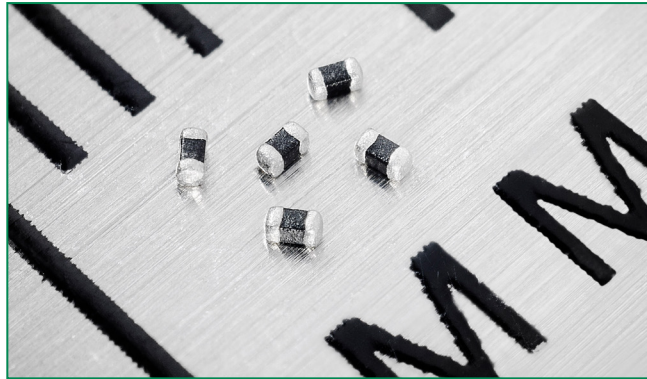

Absolute Maximum Ratings

Steady State Applied Voltage:		Unit
Maximum DC Voltage ($V_{M(DC)}$)	5.5	V
Maximum AC Voltage ($V_{M(AC)(RMS)}$)	4.0	V
Transient:		
Non-Repetitive Surge Current, 8/20 μ s Waveform, (I_{TM})	4.0	A
Temperature:		
Operating Ambient Temperature Range (T_A)	-40 to +85	°C
Storage Temperature Range (T_{STG})	-40 to +85	°C

Description

New 0201-size MLA Multi-Layer Varistor (MLV) series can protect small electronic products from electrostatic discharge (ESD) and electrically fast transients (EFT).

It's ultra-compact 0201 size, the smallest form factor available for MLV devices, is ideal for compact handheld products.

The MLA Series is manufactured from semiconducting ceramics, and is supplied in a leadless, surface mount package.

Plating consists of Silver base material (which is fired on to the Zn dielectric), Nickel barrier plated under-layer and Matte-Tin outer surface plate.

Features

- Ultra-small 0201 size for minimal board space
- Low capacitance (33pF) for high data rates to minimize signal distortion
- Meets IEC 61000-4-2 for ESD
- Low leakage (<25 μ A)
- Multilayer ceramic construction technology
- Inherently Bi-directional
- Stable performance over wide operating and storage temperature range -40°C to +85°C
- Operating voltage $V_{M(DC)} = 5.5V$
- Rated for surge current (8 x 20 μ s)
- Pb-Free and RoHS Compliant

Applications

- Portable / handheld electronic devices
- Mobile communications / cellular phones
- USB, video and audio ports
- Analog signal / sensor lines
- Data, diagnostic I/O ports
- Computer / DSP products
- Industrial instruments including non-life sustaining medical equipment

Device Ratings and Specifications

Part Number	Maximum Ratings @ +85°C			Specifications @ +25°C			
	Maximum Continuous Working Voltage		Maximum Non-repetitive Surge Current (8/20 μ s)	Maximum Clamping Voltage at 1A (8/20 μ s)	Nominal Voltage at 1mA DC Test Current		Typical Capacitance at f = 1MHz
	$V_{M(DC)}$ (V)	$V_{M(AC)}$ (V)	I_{TM} (A)	V_C (V)	$V_{N(DC)}$ Min (V)	$V_{N(DC)}$ Max (V)	C (pF)
V5.5MLA020133FR	5.5	4.0	1	28.0*	8.0	14.0	33.0
V5.5MLA020133NR	5.5	4.0	1	28.0*	8.0	14.0	33.0
V5.5MLA020147NR	5.5	4.0	1	26.0*	8.0	14.0	47.0
V5.5MLA020164NR	5.5	4.0	1	26.0*	8.0	14.0	64.0

Notes:
 - Typical leakage at 25°C at $V_{M(DC)}$: 0201 size <10 μ A typical, <25 μ A maximum
 - End surface finish of Tin with Nickel barrier on Silver base material
 - Standard packing quantity 10,000 per reel, 7" reel

Additional Information



Datasheet



Resources



Samples

Reliability and Environmental Specifications

	Judge Criteria	Test Condition
Solderability	> 95% solder coverage	245 +/- °C, 3 +/- 1 sec.
Leaching Resistance	> 95% solder coverage	245 +/- °C, 3 +/- 1 sec.
High Temperature Exposure	$\Delta V_v / V_v \leq 10\%$	1000 hours 85°C, un-powered
Thermal Shock	$\Delta V_v / V_v \leq 10\%$	-45 to +85 °C, 30 min. cycle, 5 cycles
Operating Life	$\Delta V_v / V_v \leq 10\%$	85 °C, DC working voltage 1000 hours
Bias Humidity	$\Delta V_v / V_v \leq 10\%$	40 °C / 85% RH, DC working voltage 1000 hours

Peak Pulse Current Test Waveform for Clamping Voltage

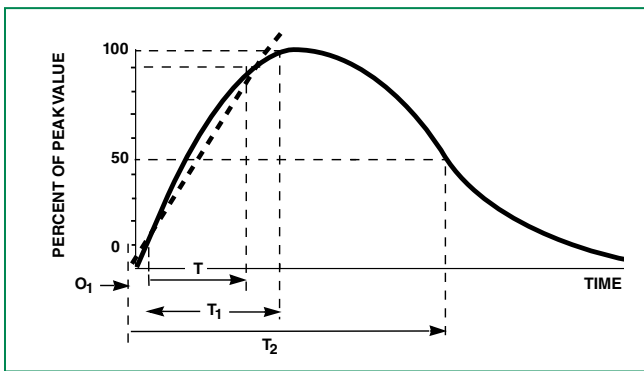

O_1 = Virtual Origin of Wave
 T = Time from 10% to 90% of Peak
 T_1 = Rise Time = 1.25 x T
 T_2 = Decay Time
Example - For an 8/20 μ s Current Waveform:
 8μ s = T_1 = Rise Time
 20μ s = T_2 = Decay Time

Multilayer Internal Construction

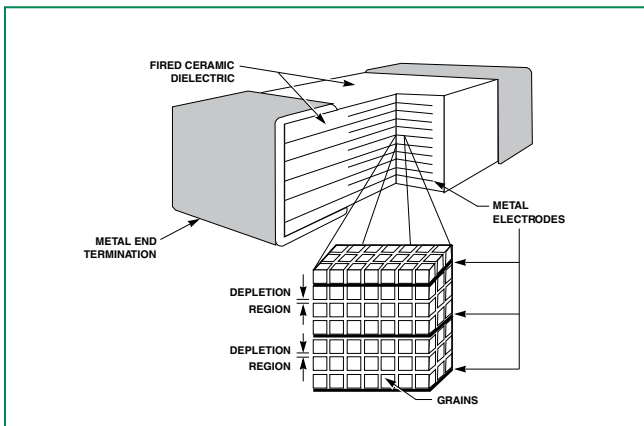

Lead-free (Pb-free) Soldering Recommendations

To avoid the possibility of generating stresses due to thermal shock, a preheat stage in the soldering process is recommended, and the peak temperature of the solder process should be rigidly controlled.

When using a reflow process, care should be taken to ensure that the ML chip is not subjected to a thermal gradient steeper than 4 degrees per second; the ideal gradient being 2 degrees per second. During the soldering process, preheating to within 100 degrees of the solder's peak temperature is essential to minimize thermal shock.

Once the soldering process has been completed, it is still necessary to ensure that any further thermal shocks are avoided. One possible cause of thermal shock is hot printed circuit boards being removed from the solder process and subjected to cleaning solvents at room temperature. The boards must be allowed to cool gradually to less than 50° C before cleaning.

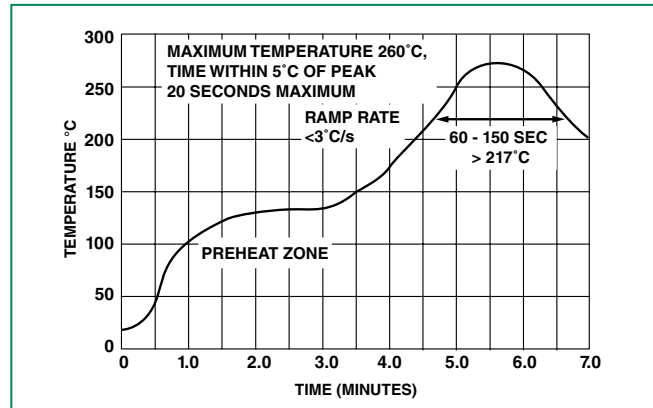

Disclaimer Notice - Information furnished is believed to be accurate and reliable. However, users should independently evaluate the suitability of and test each product selected for their own applications. Littelfuse products are not designed for, and may not be used in, all applications. Read complete Disclaimer Notice at www.littelfuse.com/disclaimer-electronics.

Product Dimensions (mm)

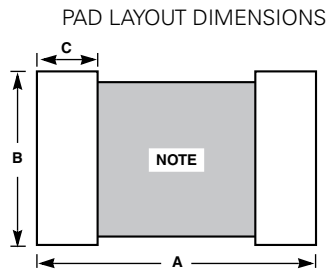

NOTE : Avoid metal runs in this area, parts not recommended for use in applications using Silver (Ag) epoxy paste.

CHIP LAYOUT DIMENSIONS

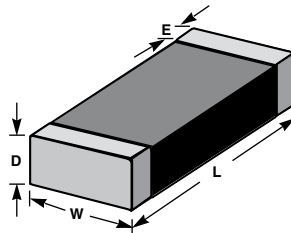

Dimension	0201 Size	
	IN	MM
A	0.055	1.40
B	0.020	0.50
C	0.020	0.50
D (max.)	0.014	0.35
E	0.008 \pm 0.004	0.20 \pm 0.10
L	0.024 \pm 0.002	0.60 \pm 0.05
W	0.012 \pm 0.002	0.30 \pm 0.05

Part Numbering System

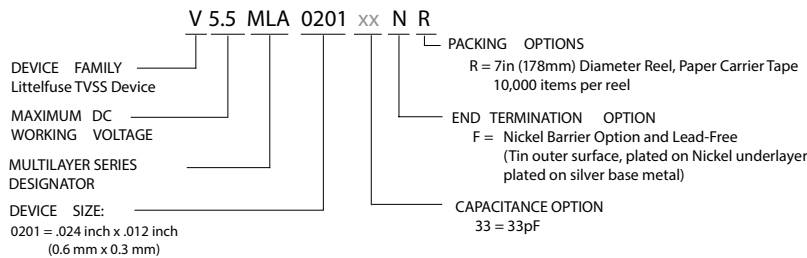

Tape and Reel Specifications

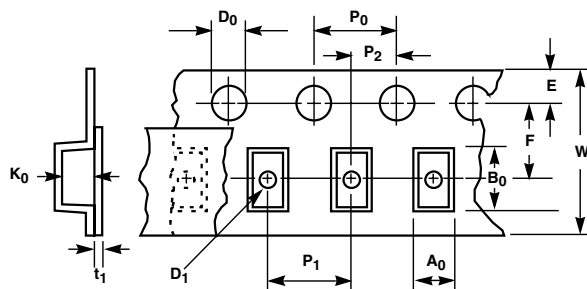

For T and H Pack Options: PLASTIC CARRIER TAPE
 For R Pack Options: EMBOSSED PAPER CARRIER TAPE

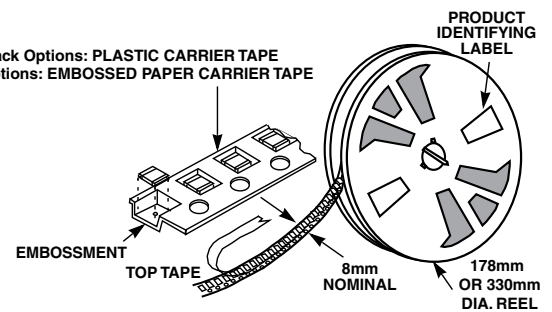

Symbol	Description	Dimensions in Millimeters
		0201
A₀	Width of Cavity	0.36 \pm 0.02
B₀	Length of Cavity	0.70 \pm 0.02
W	Width of Tape	8.0 \pm 0.1
F	Distance Between Drive Hole Centers and Cavity Centers	3.5 \pm 0.05
E	Distance Between Drive Hole Centers and Tape Edge	1.75 \pm 0.05
P₁	Distance Between Cavity Centers	2.0 \pm 0.05
P₂	Axial Drive Distance Between Drive Hole Centers & Cavity Centers	2.0 \pm 0.05
P₀	Axial Drive Distance Between Drive Hole Centers	4.0 \pm 0.1
D₀	Drive Hole Diameter	1.55 \pm 0.05
T₁	Top Tape Thickness	0.42 \pm 0.02

NOTE: It is recommended that parts be kept in the sealed bag provided and that parts be used as soon as possible when removed from bags.

MLA Varistor Series

RoHS HF



Size Table

Metric	EIA
1005	0402
1608	0603
2012	0805
3216	1206
3225	1210

Absolute Maximum Ratings

• For ratings of individual members of a series, see device ratings and specifications table.

Continuous	ML Series	Units
Steady State Applied Voltage:		
DC Voltage Range ($V_{M(DC)}$)	3.5 to 120	V
AC Voltage Range ($V_{M(AC)(RMS)}$)	2.5 to 107	V
Transient:		
Non-Repetitive Surge Current, 8/20 μ s Waveform, (I_{TM})	4 to 500	A
Non-Repetitive Surge Energy, 10/1000 μ s Waveform, (W_{TM})	0.02 to 2.5	J
Operating Ambient Temperature Range (T_A)	-55 to +125	°C
Storage Temperature Range (T_{STG})	-55 to +150	°C
Temperature Coefficient (αV) of Clamping Voltage (V_C) at Specified Test Current	<0.01	%/°C

Additional Information



Datasheet



Resources



Samples

Description

The MLA Series family of transient voltage surge suppression devices is based on the Littelfuse Multilayer fabrication technology. These components are designed to suppress a variety of transient events, including those specified in IEC 61000-4-2 or other standards used for Electromagnetic Compliance (EMC). The MLA Series is typically applied to protect integrated circuits and other components at the circuit board level.

The wide operating voltage and energy range make the MLA Series suitable for numerous applications on power supply, control and signal lines.

The MLA Series is manufactured from semiconducting ceramics, and is supplied in a leadless, surface mount package. The MLA Series is compatible with modern reflow and wave soldering procedures.

It can operate over a wider temperature range than Zener diodes, and has a much smaller footprint than plastic-housed components.

Littelfuse Inc. manufactures other multilayer series products. See the MLE Series data sheet for ESD applications, MHS Series data sheet for high-speed ESD applications, the MLN Series for multilayer protection and the AUML Series for automotive applications.

Features

- Halogen-Free and RoHS compliant
- Leadless 0402, 0603, 0805, 1206 and 1210 chip sizes
- Multilayer ceramic construction technology
- -55°C to +125°C operating temp. range
- Operating voltage range $V_{M(DC)} = 5.5V$ to 120V
- Rated for surge current ($8 \times 20\mu s$)
- Rated for energy ($10 \times 1000\mu s$)
- Inherent bi-directional clamping
- Standard low capacitance types available
- ESD rated to IEC 61000-4-2, Level 4: Air Discharge 15KV and Contact Discharge 8KV

Applications

- Suppression of inductive switching or other transient events such as EFT and surge voltage at the circuit board level
- ESD protection for IEC 61000-4-2 (Level 4), MIL-STD-883 method 3015.7, and other industry specifications (see also the MLE or MLN Series)
- Provides on-board transient voltage protection for ICS and transistors
- Used to help achieve electromagnetic compliance of end products
- Replace larger surface mount TVS Zeners in many applications

Device Ratings and Specifications

Part Number	Maximum Ratings (125° C)					Specifications (25°C)		
	Maximum Continuous Working Voltage		Maximum Non-repetitive Surge Current (8/20 μ s)	Maximum Non-repetitive Surge Energy (10/1000 μ s)	Maximum Clamping Voltage at 1A (or as Noted) (8/20 μ s)	Nominal Voltage at 1mA DC Test Current		Typical Capacitance at f = 1 MHz
	V _{M(DC)} (V)	V _{M(AC)} (V)	I _{TM} (A)	W _{TM} (J)	V _C (V)	V _{N(DC) Min} (V)	V _{N(DC) Max} (V)	C (pF)
V3.5MLA0603N ⁵	3.5	2.5	30	0.100	13.0	3.7	7.0	1270
V3.5MLA0805N	3.5	2.5	120	0.300	13.0	3.7	7.0	1760
V3.5MLA0805LN	3.5	2.5	40	0.100	13.0	3.7	7.0	1380
V3.5MLA1206N	3.5	2.5	100	0.300	13.0	3.7	7.0	5800
V5.5MLA0402N	5.5	4.0	20	0.050	21.0	7.1	10.8	220
V5.5MLA0402F ⁸	5.5	4.0	20	0.050	21.0	7.1	10.8	220
V5.5MLA0402LN	5.5	4.0	20	0.050	39.0	15.9	21.5	70
V5.5MLA0402LF ⁸	5.5	4.0	20	0.05	39	15.9	21.5	70
V5.5MLA0603N ⁵	5.5	4.0	30	0.100	17.5	7.1	9.3	960
V5.5MLA0603LN ⁴	5.5	4.0	30	0.100	17.5	7.1	9.3	450
V5.5MLA0603LF ⁸	5.5	4.0	30	0.100	17.5	7.1	9.3	450
V5.5MLA0805N	5.5	4.0	120	0.300	17.5	7.1	9.3	1200
V5.5MLA0805LN	5.5	4.0	40	0.100	17.5	7.1	9.3	660
V5.5MLA1206N	5.5	4.0	150	0.400	17.5	7.1	9.3	2800
V9MLA0402N	9.0	6.5	20	0.050	30.0	11.0	16.0	120
V9MLA0402F ⁸	9.0	6.5	20	0.050	30.0	11.0	16.0	120
V9MLA0402LN	9.0	6.5	4	0.020	35.0	11.0	16.0	33
V9MLA0402LF ⁸	9.0	6.5	4	0.020	35.0	11.0	16.0	33
V9MLA0603N ⁵	9.0	6.5	30	0.100	25.5	11.0	16.0	490
V9MLA0603LN ⁴	9.0	6.5	30	0.100	25.5	11.0	16.0	360
V9MLA0603LF ⁸	9.0	6.5	30	0.100	25.5	11.0	16.0	360
V9MLA0805LN	9.0	6.5	40	0.100	25.5	11.0	16.0	320
V12MLA0805LN	12.0	9.0	40	0.100	29.0	14.0	18.5	220
V14MLA0402N	14.0	10.0	20	0.050	39.0	15.9	21.5	70
V14MLA0402F ⁸	14.0	10.0	20	0.050	39.0	15.9	21.5	70
V14MLA0603N	14.0	10.0	30	0.100	34.5	15.9	21.5	80
V14MLA0603F ⁸	14.0	10.0	30	0.100	34.5	15.9	21.5	180
V14MLA0805N	14.0	10.0	120	0.300	32.0	15.9	20.3	360
V14MLA0805LN	14.0	10.0	40	0.100	32.0	15.9	20.3	200
V14MLA1206N	14.0	10.0	150	0.400	32.0	15.9	20.3	800
V18MLA0402N	18.0	14.0	20	0.050	50.0	22.0	28.0	40
V18MLA0402F ⁸	18.0	14.0	20	0.050	50.0	22.0	28.0	40
V18MLA0603N	18.0	14.0	30	0.100	50.0	22.0	28.0	60
V18MLA0603F ⁸	18.0	14.0	30	0.100	50.0	22.0	28.0	120
V18MLA0805N	18.0	14.0	120	0.300	44.0	22.0	28.0	260
V18MLA0805LN	18.0	14.0	40	0.100	44.0	22.0	28.0	170
V18MLA1206N	18.0	14.0	150	0.400	44.0	22.0	28.0	1030
V18MLA1210N	18.0	14.0	500	2.500	44.0 at 2.5	22.0	28.0	2500
V18MLA1812N ⁷	18.0	14.0	1000	2.900	44.0 at 5	22.0	28.0	4050
V26MLA0603N	26.0	20.0	30	0.100	60.0	31.0	38.0	55
V26MLA0603F ⁸	26.0	20.0	30	0.100	60.0	31.0	38.0	110
V26MLA0805N	26.0	20.0	100	0.300	60.0	29.5	38.5	110
V26MLA0805LN	26.0	20.0	40	0.100	60.0	29.5	38.5	90
V26MLA1206N	26.0	20.0	150	0.600	60.0	29.5	38.5	630
V26MLA1210N	26.0	20.0	300	1.200	60.0 at 2.5	29.5	38.5	1250
V30MLA0603N	30.0	25.0	30	0.100	74.0	37.0	46.0	45
V30MLA0603F ⁸	30.0	25.0	30	0.100	74.0	37.0	46.0	90
V30MLA0805LN	30.0	25.0	30	0.100	72.0	37.0	46.0	85
V30MLA1206N	30.0	25.0	180	1.000	67.0	35.0	43.0	400
V30MLA1210N	30.0	25.0	280	1.200	68.0 at 2.5	35.0	43.0	685
V30MLA1210LN	30.0	25.0	220	0.900	68.0 at 2.5	35.0	43.0	500

Device Ratings and Specifications (Continue...)

Part Number	Maximum Ratings (125° C)				Specifications (25° C)			
	Maximum Continuous Working Voltage		Maximum Non-repetitive Surge Current (8/20 μ s)	Maximum Non-repetitive Surge Energy (10/1000 μ s)	Maximum Clamping Voltage at 1A (or as Noted) (8/20 μ s)	Nominal Voltage at 1mA DC Test Current		Typical Capacitance at f = 1MHz
	V _{M(DC)} (V)	V _{M(AC)} (V)	I _{TM} (A)	W _{TM} (J)	V _c (V)	V _{N(DC) Min} (V)	V _{N(DC) Max} (V)	C (pF)
V30MLA1812N ⁷	30.0	25.0	800	3.700	65.0 at 5	35.0	43.0	1900
V33MLA1206N	33.0	26.0	180	0.800	75.0	38.0	49.0	390
V38MLA1812N ⁷	38.0	30.0	800	4.500	77.0 at 5	43.0	52.0	1450
V42MLA1206N	42.0	30.0	180	0.800	92.0	46.0	60.0	345
V45MLA1812N ⁷	45.0	35.0	500	4.000	90.0 at 5	50.4	61.6	1200
V48MLA1206N	48.0	40.0	180	0.900	100.0	54.5	66.5	185
V48MLA1210N	48.0	40.0	250	1.200	105.0 at 2.5	54.5	66.5	400
V48MLA1210LN	48.0	40.0	220	0.900	105.0 at 2.5	54.5	66.5	380
V56MLA1206N	56.0	40.0	180	1.000	120.0	61.0	77.0	180
V60MLA1210N	60.0	50.0	250	1.500	130.0 at 2.5	67.0	83.0	230
V68MLA1206N	68.0	50.0	180	1.000	140.0	76.0	90.0	130
V85MLA1210N	85.0	67.0	250	2.500	180.0 at 2.5	95.0	115.0	160
V120MLA1210N	120.0	107.0	125	2.000	260.0 at 2.5	135.0	165.0	70

- NOTES:
- 1 'L' suffix is a low capacitance and energy version; Contact your Littelfuse sales representative for custom capacitance requirements.
 - 2 Typical leakage at 25°C < 25 μ A, maximum leakage 100 μ A at V_{M(DC)} for 0402 size, typical leakage < 5 μ A, maximum leakage < 20 μ A at V_{M(DC)}.
 - 3 Average power dissipation of transients for 0402, 0603, 0805, 1206 and 1210 sizes not to exceed 0.03W, 0.05W, 0.1W, 0.1W and 0.15W respectively.
 - 4 Item is available as 'R' packing option only. All 0402 size items available as 'R' packaging option only. See Packaging section for additional information.
 - 5 Item is available in 'H', 'T' and 'A' packing option only. All 0805, 1206 and 1210 parts come as 'H', 'T' and 'A' packing option only. See Packaging section for additional information.
 - 6 The typical capacitance rating is the discrete component test result.
 - 7 Item is available in 'T' packing option only.
 - 8 Item is available in 'R' packing option only, and lead free.

Peak Current and Energy Derating Curve

When transients occur in rapid succession, the average power dissipation is the energy (watt-seconds) per pulse times the number of pulses per second. The power so developed must be within the specifications shown on the Device Ratings and Specifications Table for the specific device. For applications exceeding 125°C ambient temperature, the peak surge current and energy ratings must be derated as shown below.

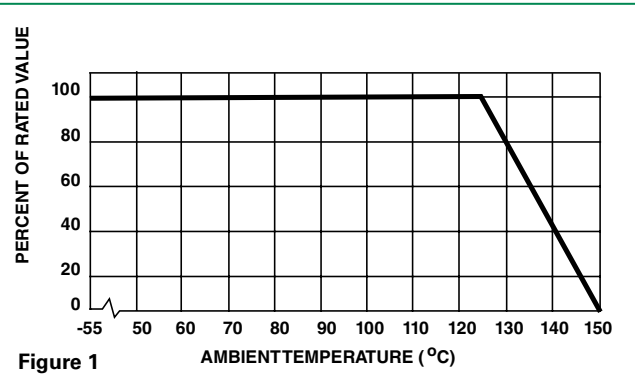

Peak Pulse Current Test Waveform for Clamping Voltage

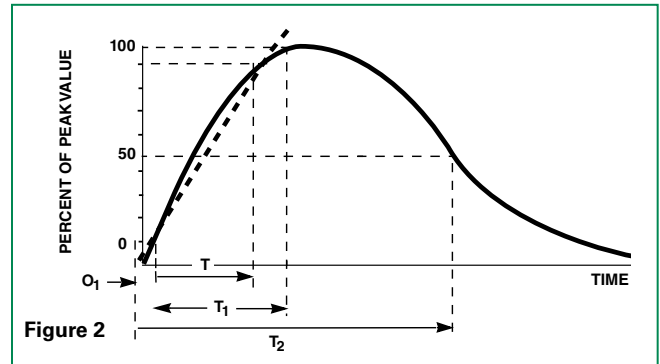

- O_1 = Virtual Origin of Wave
- T = Time from 10% to 90% of Peak
- T_1 = Rise Time = $1.25 \times T$
- T_2 = Decay Time

Example - For an 8/20 μ s Current Waveform:
 $8\mu s = T_1$ = Rise Time
 $20\mu s = T_2$ = Decay Time

Limit V-I Characteristic for V5.5MLA0402 to V18MLA0402

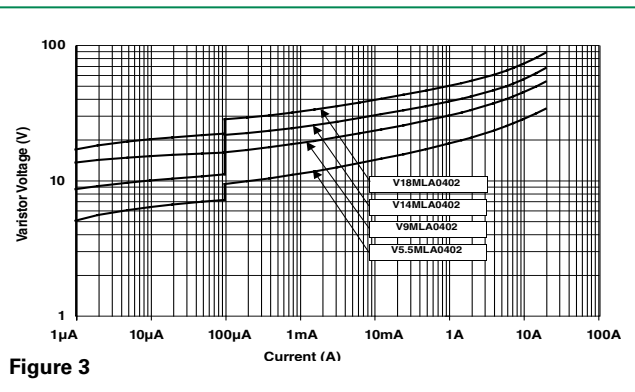

Limit V-I Characteristic for V9MLA0402L

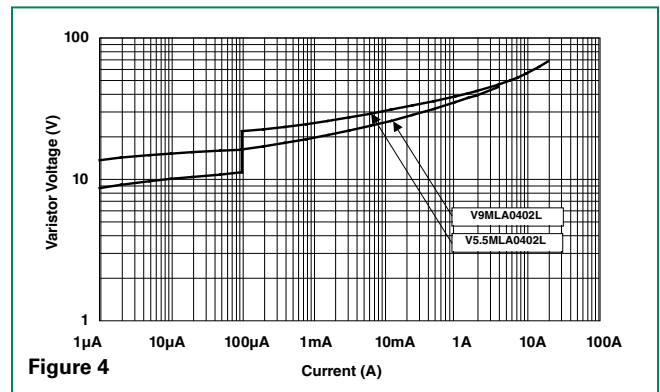

Limit V-I Characteristic for V3.5MLA0603 to V30MLA0603

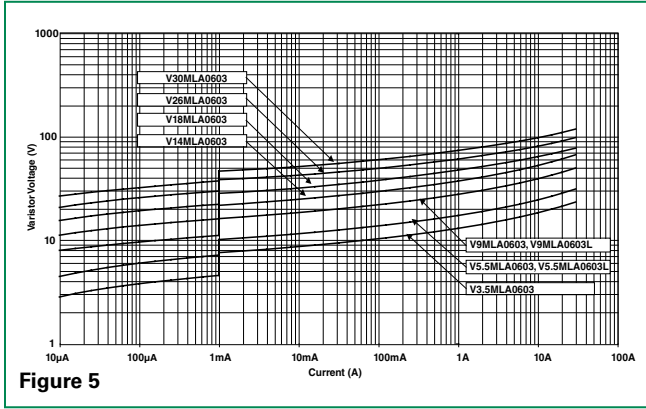

Figure 5

Limit V-I Characteristic for V3.5MLA0805L to V30MLA0805L

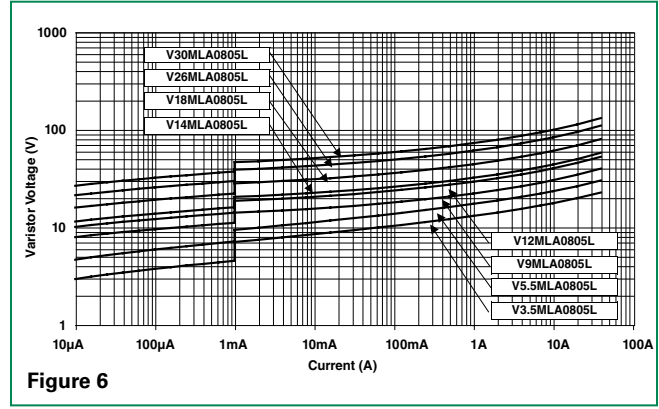

Figure 6

Limit V-I Characteristic for V3.5MLA0805 to V26MLA0805

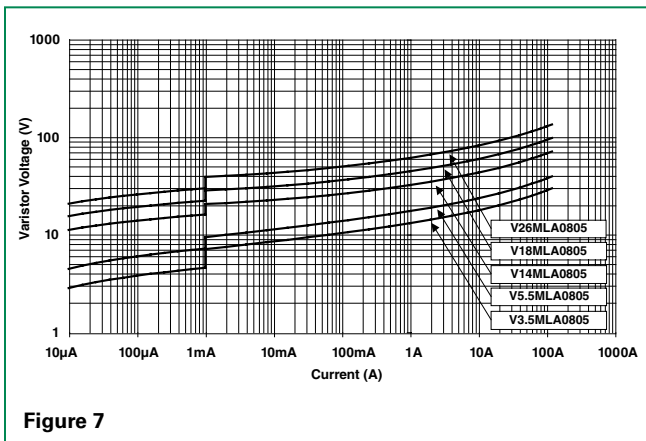

Figure 7

Limit V-I Characteristic for V3.5MLA1206 to V68MLA1206

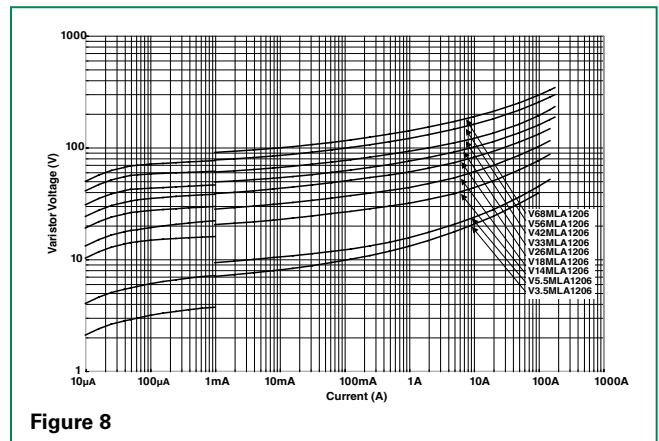

Figure 8

Limit V-I Characteristic for V18MLA1210 to V120MLA1210

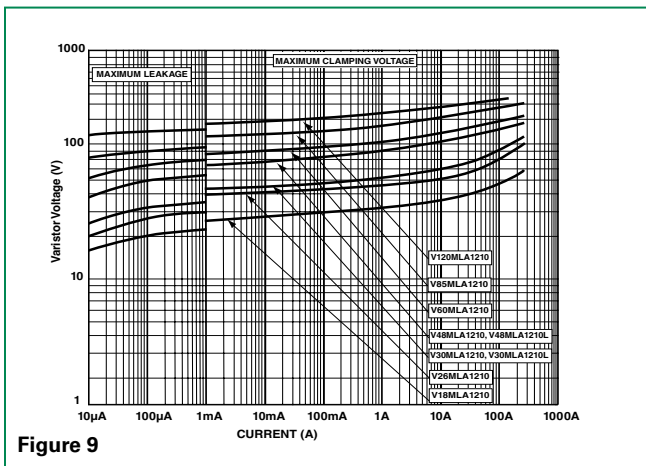

Figure 9

Device Characteristics

At low current levels, the V-I curve of the multilayer transient voltage suppressor approaches a linear (ohmic) relationship and shows a temperature dependent effect. At or below the maximum working voltage, the suppressor is in a high resistance modex (approaching $10^6\Omega$ at its maximum rated working voltage). Leakage currents at maximum rated voltage are below $100\mu A$, typically $25\mu A$; for 0402 size below $20\mu A$, typically $5\mu A$.

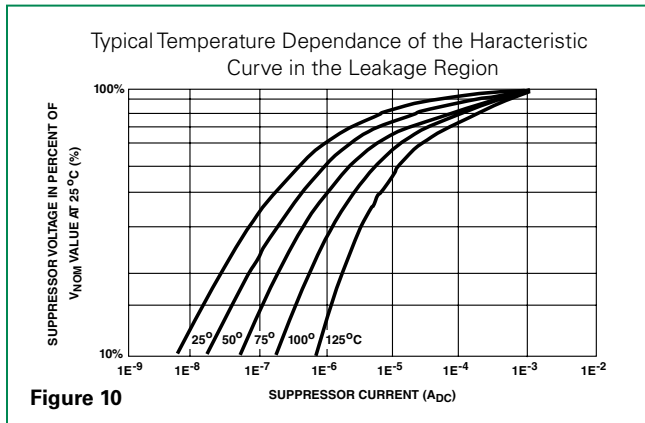

Figure 10

Speed of Response

The Multilayer Suppressor is a leadless device. Its response time is not limited by the parasitic lead inductances found in other surface mount packages. The response time of the $Z_{N}O$ dielectric material is less than 1ns and the MLA can clamp very fast dV/dT events such as ESD. Additionally, in "real world" applications, the associated circuit wiring is often the greatest factor effecting speed of response. Therefore, transient suppressor placement within a circuit can be considered important in certain instances.

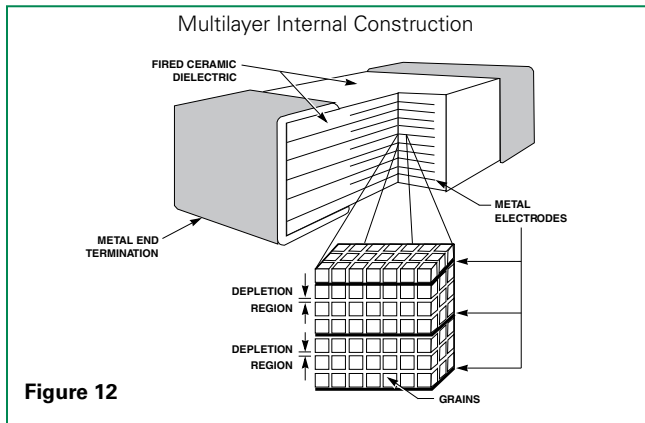

Figure 12

Clamping Voltage Over Temperature (V_c at 10A)

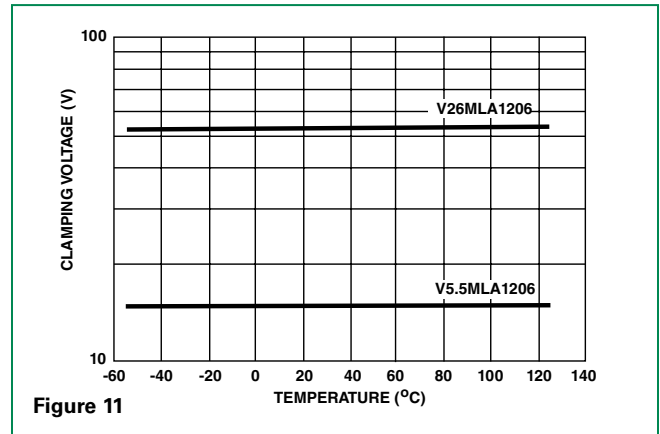

Figure 11

Energy Absorption/Peak Current Capability

Energy dissipated within the MLA Series is calculated by multiplying the clamping voltage, transient current and transient duration. An important advantage of the multilayer is its interdigitated electrode construction within the mass of dielectric material. This results in excellent current distribution and the peak temperature per energy absorbed is very low. The matrix of semiconducting grains combine to absorb and distribute transient energy (heat) (see Speed of Response). This dramatically reduces peak temperature; thermal stresses and enhances device reliability.

As a measure of the device capability in energy and peak current handling, the V26MLA1206A part was tested with multiple pulses at its peak current rating (3A, 8/20 μs). At the end of the test, 10,000 pulses later, the device voltage characteristics are still well within specification.

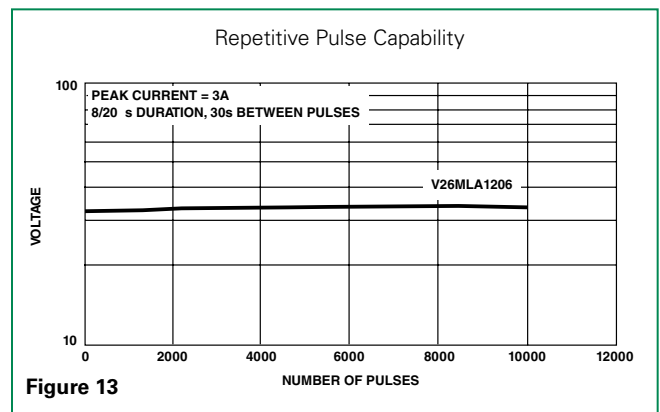

Figure 13

Lead (Pb) Soldering Recommendations

The principal techniques used for the soldering of components in surface mount technology are IR Re-flow and Wave soldering. Typical profiles are shown on the right.

The recommended solder for the MLA suppressor is a 62/36/2 (Sn/Pb/Ag), 60/40 (Sn/Pb) or 63/37 (Sn/Pb). Littelfuse also recommends an RMA solder flux.

Wave soldering is the most strenuous of the processes. To avoid the possibility of generating stresses due to thermal shock, a preheat stage in the soldering process is recommended, and the peak temperature of the solder process should be rigidly controlled.

When using a reflow process, care should be taken to ensure that the MLA chip is not subjected to a thermal gradient steeper than 4 degrees per second; the ideal gradient being 2 degrees per second. During the soldering process, preheating to within 100 degrees of the solder's peak temperature is essential to minimize thermal shock.

Once the soldering process has been completed, it is still necessary to ensure that any further thermal shocks are avoided. One possible cause of thermal shock is hot printed circuit boards being removed from the solder process and subjected to cleaning solvents at room temperature. The boards must be allowed to cool gradually to less than 50° C before cleaning.

Reflow Solder Profile

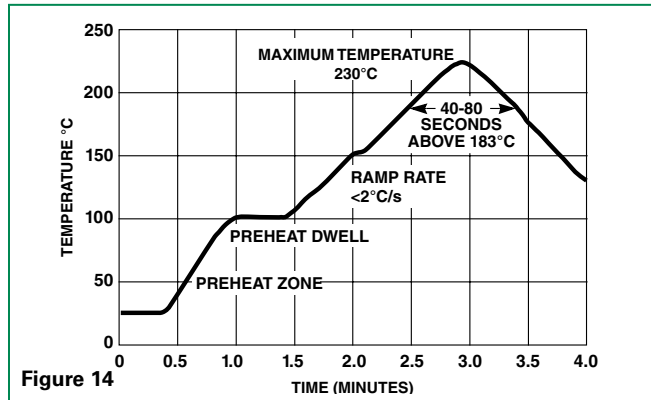

Wave Solder Profile

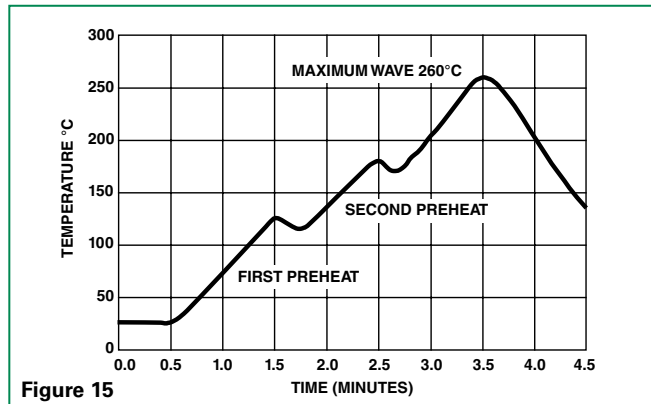

Lead-free (Pb-free) Soldering Recommendations

Littelfuse offers the Nickel Barrier Termination option (see "N" suffix in Part Numbering System for ordering) for the optimum Lead-free solder performance, consisting of a Matte Tin outer surface plated on Nickel underlayer, plated on Silver base metal.

The preferred solder is 96.5/3.0/0.5 (SnAgCu) with an RMA flux, but there is a wide selection of pastes and fluxes available with which the Nickel Barrier parts should be compatible.

The reflow profile must be constrained by the maximums in the Lead-free Reflow Profile. For Lead-free wave soldering, the Wave Solder Profile still applies.

Note: the Lead-free paste, flux and profile were used for evaluation purposes by Littelfuse, based upon industry standards and practices. There are multiple choices of all three available, it is advised that the customer explores the optimum combination for their process as processes vary considerably from site to site.

Lead-free Re-flow Solder Profile

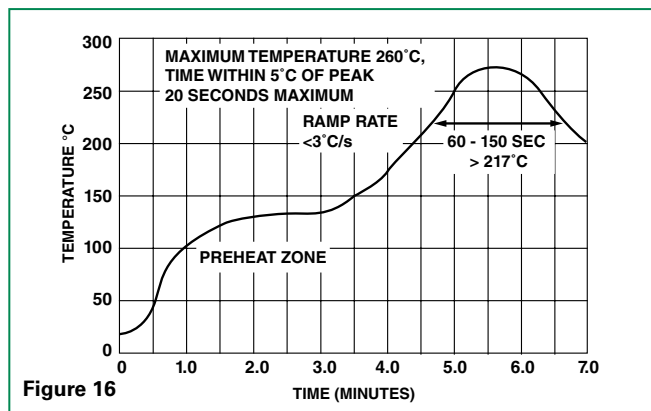

Product Dimensions (mm)

PAD LAYOUT DIMENSIONS

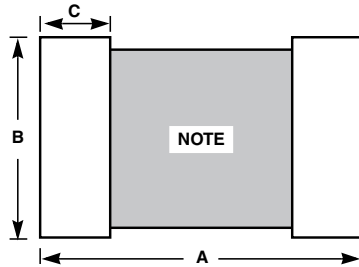

CHIP LAYOUT DIMENSIONS

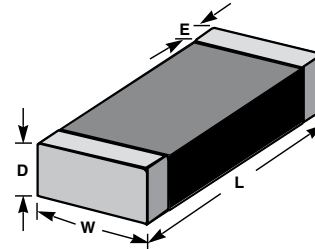

NOTE : Avoid metal runs in this area, parts not recommended for use in applications using Silver (Ag) epoxy paste.

Dimension	1210 Size		1206 Size		0805 Size		0603 Size		0402 Size	
	IN	MM	IN	MM	IN	MM	IN	MM	IN	MM
A	0.160	4.06	0.160	4.06	0.120	3.05	0.100	2.54	0.067	1.70
B	0.100	2.54	0.065	1.65	0.050	1.27	0.030	0.76	0.020	0.51
C	0.040	1.02	0.040	1.02	0.040	1.02	0.035	0.89	0.024	0.61
D (max.)	0.113	2.87	0.071	1.80	0.043	1.10	0.040	1.00	0.024	0.60
E	0.020 -/+0.010	0.50 -/+0.25	0.020 -/+0.010	0.50 -/+0.25	0.020 -/+ 0.010	0.50 -/+ 0.25	0.015 -/+0.008	0.4 -/+0.20	0.010 -/+0.006	0.25 -/+0.15
L	0.125 -/+0.012	3.20 -/+0.30	0.125 -/+0.012	3.20 -/+0.30	0.079 -/+0.008	2.01 -/+0.20	0.063 -/+0.006	1.6 -/+0.15	0.039 -/+0.004	1.00 -/+0.10
W	0.100 -/+0.012	2.54 -/+0.30	0.060 -/+0.011	1.60 -/+0.28	0.049 -/+0.008	1.25 -/+0.20	0.032 -/+0.060	0.8 -/+0.15	0.020 -/+0.004	0.50 -/+0.10

Part Numbering System

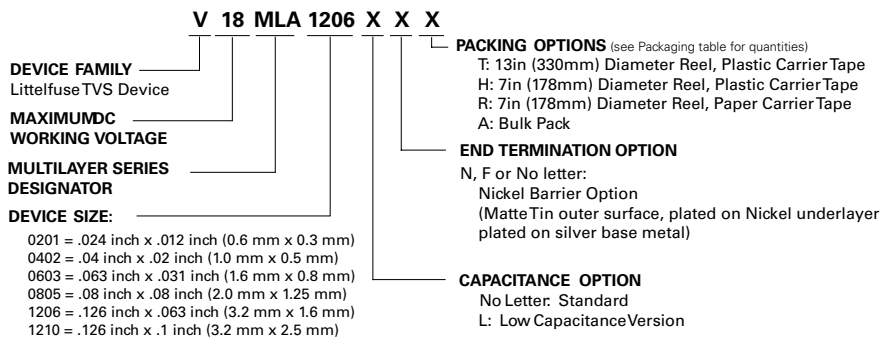

*NOTES:
 1 V120MLA1210 standard shipping quantities are 1000 pieces per reel for the "H" option and 4000 pieces per reel for "T" option.
 2 V3.5 MLA0603, V5.5 MLA0603 and V9 MLA0603 only available in "H," "T" and "A" packing options.

Packaging*

Device Size	Quantity			
	13" Inch Reel ("T" Option)	7" Inch Reel ("H" Option)	7" Inch Reel ("R" Option)	Bulk Pack ("A" Option)
1812	4,000	N/A	N/A	N/A
1210	8,000	2,000	N/A	2,000
1206	10,000	2,500	N/A	2,500
0805	10,000	2,500	N/A	2,500
0603	10,000	2,500	4,000	2,500
0402	N/A	N/A	10,000	N/A

*(Packaging) It is recommended that parts be kept in the sealed bag provided and that parts be used as soon as possible when removed from bags.

Tape and Reel Specifications

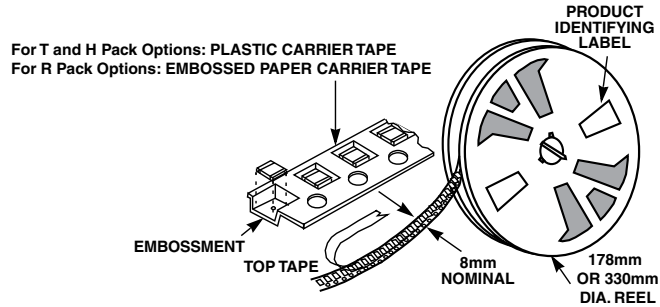
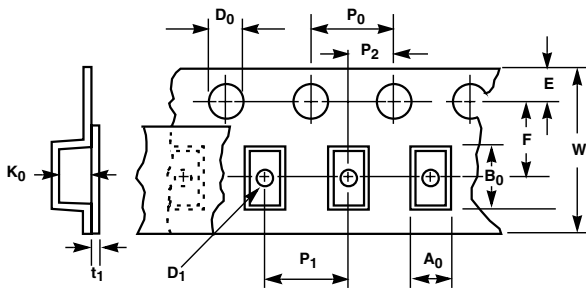

Symbol	Description	Dimensions in Millimeters	
		0402 Size	0603, 0805, 1206 & 1210 Sizes
A₀	Width of Cavity	Dependent on Chip Size to Minimize Rotation.	
B₀	Length of Cavity	Dependent on Chip Size to Minimize Rotation.	
K₀	Depth of Cavity	Dependent on Chip Size to Minimize Rotation.	
W	Width of Tape	8 -/+0.2	8 -/+0.3
F	Distance Between Drive Hole Centers and Cavity Centers	3.5 -/+0.05	3.5 -/+0.05
E	Distance Between Drive Hole Centers and Tape Edge	1.75 -/+0.1	1.75 -/+0.1
P₁	Distance Between Cavity Centers	2 -/+0.05	4 -/+0.1
P₂	Axial Drive Distance Between Drive Hole Centers & Cavity Centers	2 -/+0.1	2 -/+0.1
P₀	Axial Drive Distance Between Drive Hole Centers	4 -/+0.1	4 -/+0.1
D₀	Drive Hole Diameter	1.55 -/+0.05	1.55 -/+0.05
D₁	Diameter of Cavity Piercing	N/A	1.05 -/+0.05
T₁	Top Tape Thickness	0.1 Max	0.1 Max

NOTES:
 • Conforms to EIA-481-1, Revision A
 • Can be supplied to IEC publication 286-3

Disclaimer Notice - Information furnished is believed to be accurate and reliable. However, users should independently evaluate the suitability of and test each product selected for their own applications. Littelfuse products are not designed for, and may not be used in, all applications. Read complete Disclaimer Notice at www.littelfuse.com/disclaimer-electronics.

MLA Automotive Varistor Series

 **AUTOMOTIVE GRADE**  **RoHS**  **HF**



Size Table

Metric	EIA
1608	0603
2012	0805
3216	1206
3225	1210

Absolute Maximum Ratings

• For ratings of individual members of a series, see device ratings and specifications table.

Continuous	MLA Auto Series	Units
Steady State Applied Voltage:		
DC Voltage Range (V_{MDCI})	3.5 to 120	V
AC Voltage Range ($V_{MIACIRMS}$)	2.5 to 107	V
Transient:		
Non-Repetitive Surge Current, 8/20 μ s Waveform, (I_{TM})	up to 500	A
Non-Repetitive Surge Energy, 10/1000 μ s Waveform, (W_{TM})	0.1 to 2.5	J
Operating Ambient Temperature Range (T_A)	-55 to +125	°C
Storage Temperature Range (T_{STG})	-55 to +150	°C
Temperature Coefficient (aV) of Clamping Voltage (V_C) at Specified Test Current	<0.01	%/°C

Additional Information



Datasheet



Resources



Samples

Description

The MLA Automotive Series of transient voltage surge suppression devices is based on the Littelfuse Multilayer fabrication technology. These components are designed to suppress a variety of transient events, including those specified in IEC 61000-4-2 or other standards used for Electromagnetic Compliance (EMC). The MLA Automotive Series is typically applied to protect integrated circuits and other components at the circuit board level.

The wide operating voltage and energy range make the MLA Automotive Series suitable for numerous applications on power supply, control and signal lines.

The MLA Automotive Series is manufactured from semiconducting ceramics, and is supplied in a leadless, surface mount package. The MLA Automotive Series is compatible with modern reflow and wave soldering procedures.

It can operate over a wider temperature range than Zener diodes, and has a much smaller footprint than plastic-housed components.

Features

- AEC-Q200 qualified
- Halogen-Free and RoHS compliant
- Leadless 0603, 0805, 1206 and 1210 chip sizes
- Multilayer ceramic construction technology
- -55°C to +125°C operating temp. range
- Operating voltage range $V_{MDCI} = 3.5V$ to 120V
- Rated for surge current (8 x 20 μ s)
- Rated for energy (10 x 1000 μ s)
- Inherent bi-directional clamping
- No plastic or epoxy packaging assures better than UL94V-0 flammability rating
- Standard low capacitance types available
- Load Dump energy rated per SAE Specification J1113

Applications

- Suppression of inductive switching or other transient events such as EFT and surge voltage at the circuit board level
- ESD protection for IEC 61000-4-2, MIL-STD-883c method 3015.7, and other industry specifications
- Provides on-board transient voltage protection for ICS and transistors
- Used to help achieve electromagnetic compliance of end products
- Replaces larger surface mount TVS Zeners in many applications

Device Ratings and Specifications

Part Number	Maximum Ratings (125° C)							Specifications (25°C)		
	Maximum Continuous Working Voltage		Jump Start Voltage (5 min)	Load Dump Energy	Maximum Non-repetitive Surge Current (8/20µs)	Maximum Non-repetitive Surge Energy (10/1000µs)	Maximum Clamping Voltage at 1A (or as Noted) (8/20µs)	Nominal Voltage at 1mA DC Test Current		Typical Capacitance at f = 1MHz
	V _{M(DC)}	V _{M(AC)}	V _{JUMP}	W _{LD}	I _{TM}	W _{TM}	V _C	V _{N(DC) Min}	V _{N(DC) Max}	C
	(V)	(V)	(V)	(J)	(A)	(J)	(V)	(V)	(V)	(pF)
V3.5MLA0603NHAUTO	3.5	2.5	--	--	30	0.100	13.0	3.7	7.0	860
V3.5MLA0805NHAUTO	3.5	2.5	--	--	120	0.300	13.0	3.7	7.0	1500
V3.5MLA0805LNHAUTO	3.5	2.5	--	--	40	0.100	13.0	3.7	7.0	1080
V3.5MLA1206NHAUTO	3.5	2.5	--	--	100	0.300	13.0	3.7	7.0	3000
V5.5MLA0603NHAUTO	5.5	4.0	--	--	30	0.100	17.5	7.1	9.3	830
V5.5MLA0805NHAUTO	5.5	4.0	--	--	120	0.300	17.5	7.1	9.3	1200
V5.5MLA0805LNHAUTO	5.5	4.0	--	--	40	0.100	17.5	7.1	9.3	400
V5.5MLA1206NHAUTO	5.5	4.0	--	--	150	0.400	17.5	7.1	9.3	2900
V9MLA0603NHAUTO	9.0	6.5	--	--	30	0.100	25.5	11.0	16.0	210
V9MLA0805LNHAUTO	9.0	6.5	--	--	40	0.100	25.5	11.0	16.0	400
V12MLA0805LNHAUTO	12.0	9.0	--	--	40	0.100	29.0	14.0	18.5	210
V14MLA0603NHAUTO	14.0	10.0	--	--	30	0.100	34.5	15.9	21.5	90
V14MLA0805NHAUTO	14.0	10.0	--	--	120	0.300	32.0	15.9	20.3	560
V14MLA0805LNHAUTO	14.0	10.0	--	--	40	0.100	32.0	15.9	20.3	320
V14MLA1206NHAUTO	14.0	10.0	--	--	150	0.400	32.0	15.9	20.3	800
V18MLA0603NHAUTO	18.0	14.0	24.5	0.3	30	0.100	50.0	22.0	28.0	120
V18MLA0805NHAUTO	18.0	14.0	24.5	1	120	0.300	44.0	22.0	28.0	245
V18MLA0805LNHAUTO	18.0	14.0	24.5	0.7	40	0.100	44.0	22.0	28.0	180
V18MLA1206NHAUTO	18.0	14.0	24.5	1.5	150	0.400	44.0	22.0	28.0	1050
V18MLA1210NHAUTO	18.0	14.0	24.5	3	500	2.500	44.0 at 2.5	22.0	28.0	2500
V26MLA0603NHAUTO	26.0	20.0	27.5	0.4	30	0.100	60.0	31.0	38.0	50
V26MLA0805NHAUTO	26.0	20.0	27.5	1	100	0.300	60.0	29.5	38.5	110
V26MLA0805LNHAUTO	26.0	20.0	27.5	0.7	40	0.100	60.0	29.5	38.5	90
V26MLA1206NHAUTO	26.0	20.0	27.5	1.5	150	0.600	60.0	29.5	38.5	600
V26MLA1210NHAUTO	26.0	20.0	27.5	3	300	1.200	60.0 at 2.5	29.5	38.5	1260
V30MLA0603NHAUTO	30.0	25.0	29	0.4	30	0.100	74.0	37.0	46.0	45
V30MLA0805LNHAUTO	30.0	25.0	29	0.7	30	0.100	72.0	37.0	46.0	80
V30MLA1210NHAUTO	30.0	25.0	29	3	280	1.200	68.0 at 2.5	35.0	43.0	690
V30MLA1210LNHAUTO	30.0	25.0	29	3	220	0.900	68.0 at 2.5	35.0	43.0	500
V33MLA1206NHAUTO	33.0	26.0	36	1.5	180	0.800	75.0	38.0	49.0	380
V42MLA1206NHAUTO	42.0	30.0	48	1.5	180	0.800	92.0	46.0	60.0	340
V48MLA1210NHAUTO	48.0	40.0	48	3	250	1.200	105.0 at 2.5	54.5	66.5	400
V48MLA1210LNHAUTO	48.0	40.0	-	-	220	0.90	105.0 at 2.5	54.5	66.5	320
V48MLA1206NHAUTO	48.0	40.0	48	1.5	180	0.90	100	54.5	66.5	180
V56MLA1206NHAUTO	56.0	40.0	48	1.5	180	1.00	120.0	61.0	77.0	150
V60MLA1210NHAUTO	60.0	50.0	48	3	250	1.50	130.0 at 2.5	67.0	83.0	230
V68MLA1206NHAUTO	68.0	50.0	48	1.5	180	1.00	140.0	76.0	90.0	130
V85MLA1210NHAUTO	85.0	67.0	48	3	150	2.50	180.0 at 2.5	95.0	115.0	160
V120MLA1210NHAUTO	120.0	107.0	48	3	125	2.00	260.0 at 2.5	135.0	165.0	80

NOTES:

- 'L' suffix is a low capacitance and energy version; Contact your Littelfuse sales representative for custom capacitance requirements
- Typical leakage at 25°C < 25µA, maximum leakage 100µA at V_{M(DC)}
- Average power dissipation of transients for 0603, 0805, 1206 and 1210 sizes not to exceed 0.05W, 0.1W, 0.1W and 0.15W respectively
- Load dump :min. time of energy input 40ms, interval 60sec(the load dump time constant Td differs from the time constant of energy input; load dump rating for ISO 7637-2 pulse 5a and ISO16750-2 Table 5A. Please contact Littelfuse.

Peak Current and Energy Derating Curve

When transients occur in rapid succession, the average power dissipation is the energy (watt-seconds) per pulse times the number of pulses per second. The power so developed must be within the specifications shown on the Device Ratings and Specifications Table for the specific device. For applications exceeding 125°C ambient temperature, the peak surge current and energy ratings must be derated as shown below.

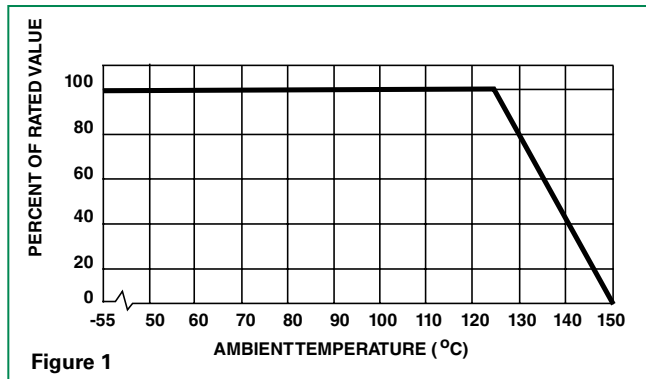

Peak Pulse Current Test Waveform for Clamping Voltage

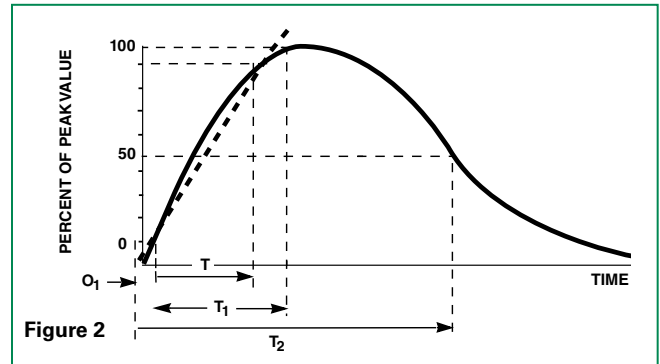

- O_1 = Virtual Origin of Wave
- T = Time from 10% to 90% of Peak
- T_1 = Rise Time = $1.25 \times T$
- T_2 = Decay Time

Example - For an 8/20 μs Current Waveform:
 $8\mu\text{s} = T_1$ = Rise Time
 $20\mu\text{s} = T_2$ = Decay Time

Limit V-I Characteristic for V3.5MLA0603NHAUTO to V30MLA0603NHAUTO

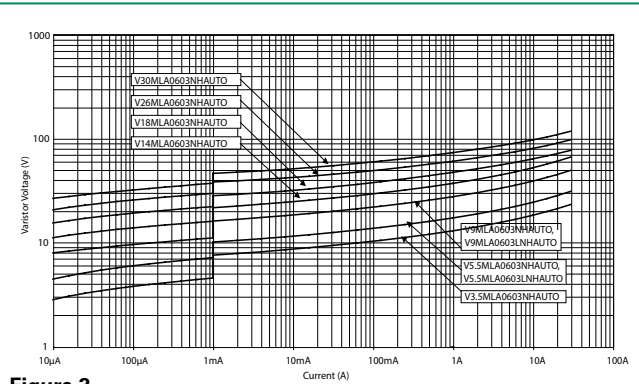

Figure 3

Limit V-I Characteristic for V3.5MLA0805LNHAUTO to V30MLA0805LNHAUTO

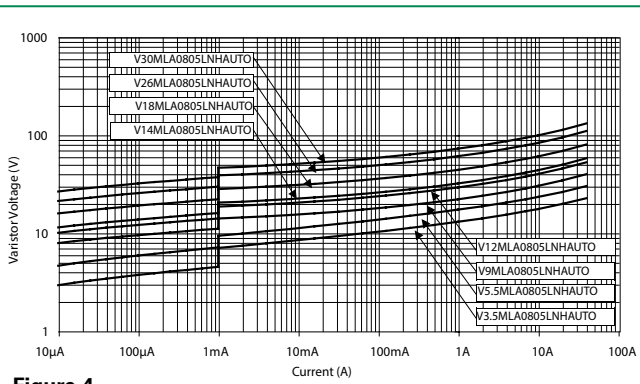

Figure 4

Limit V-I Characteristic for V3.5MLA0805NHAUTO to V26MLA0805NHAUTO

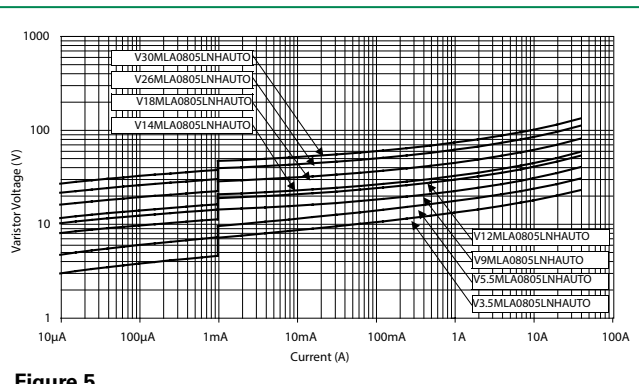

Figure 5

Limit V-I Characteristic for V3.5MLA1206NHAUTO to V42MLA1206NHAUTO

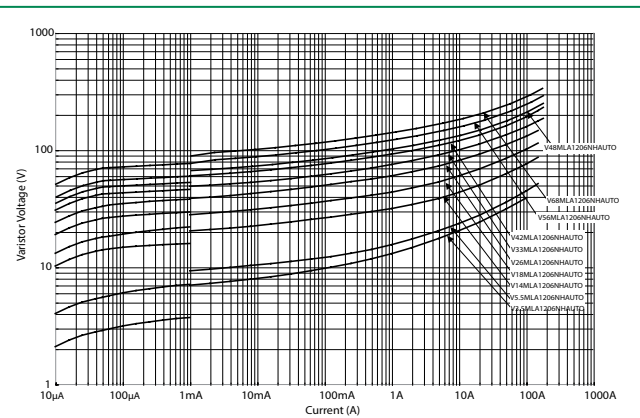

Figure 7

Limit V-I Characteristic for V18MLA1210NHAUTO to V48MLA1210NHAUTO

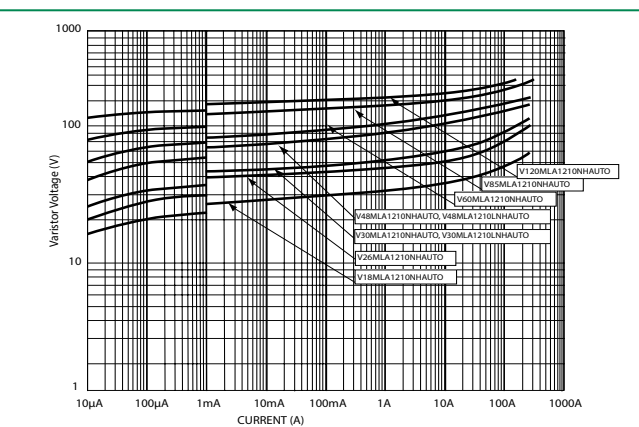

Figure 6

Device Characteristics

At low current levels, the V-I curve of the multilayer transient voltage suppressor approaches a linear (ohmic) relationship and shows a temperature dependent effect. At or below the maximum working voltage, the suppressor is in a high resistance modex (approaching $10^6\Omega$ at its maximum rated working voltage). Leakage currents at maximum rated voltage are below $100\mu A$, typically $25\mu A$.

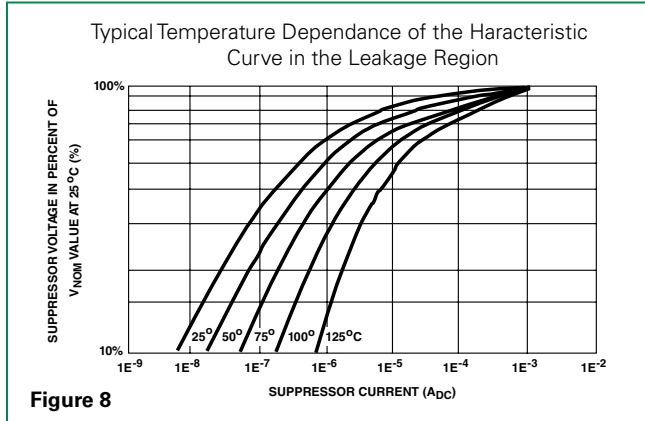

Figure 8

Speed of Response

The Multilayer Suppressor is a leadless device. Its response time is not limited by the parasitic lead inductances found in other surface mount packages. The response time of the Z_{nO} dielectric material is less than 1ns and the MLA Automotive Series can clamp very fast dV/dT events such as ESD. Additionally, in "real world" applications, the associated circuit wiring is often the greatest factor effecting speed of response. Therefore, transient suppressor placement within a circuit can be considered important in certain instances.

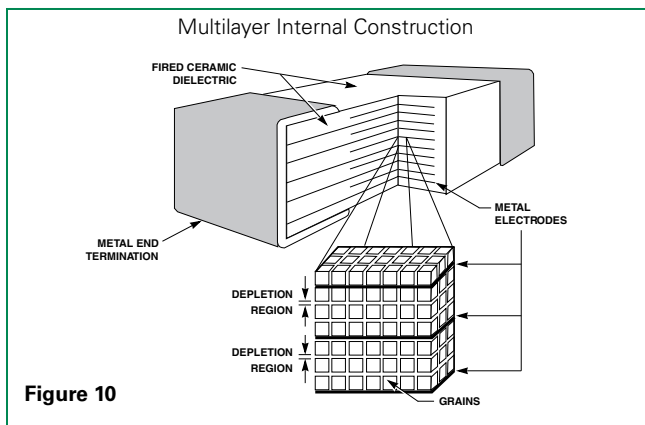

Figure 10

Clamping Voltage Over Temperature (V_c at 10A)

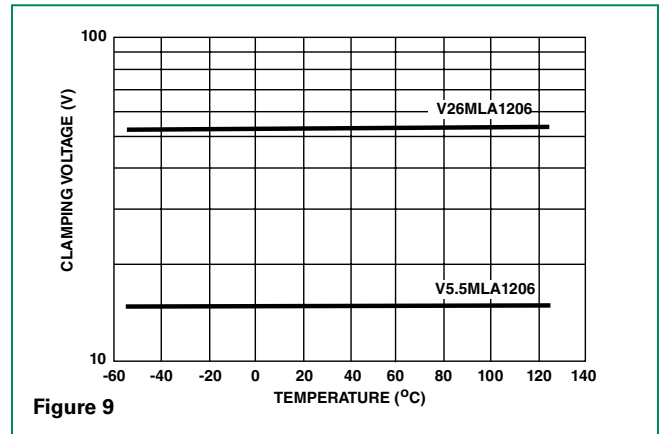

Figure 9

Energy Absorption/Peak Current Capability

Energy dissipated within the MLA Automotive Series is calculated by multiplying the clamping voltage, transient current and transient duration. An important advantage of the multilayer is its interdigitated electrode construction within the mass of dielectric material. This results in excellent current distribution and the peak temperature per energy absorbed is very low. The matrix of semiconducting grains combine to absorb and distribute transient energy (heat) (see Speed of Response). This dramatically reduces peak temperature; thermal stresses and enhances device reliability.

As a measure of the device capability in energy and peak current handling, the V26MLA1206 part was tested with multiple pulses at its peak current rating ($150A, 8/20\mu s$). At the end of the test, 10,000 pulses later, the device voltage characteristics are still well within specification.

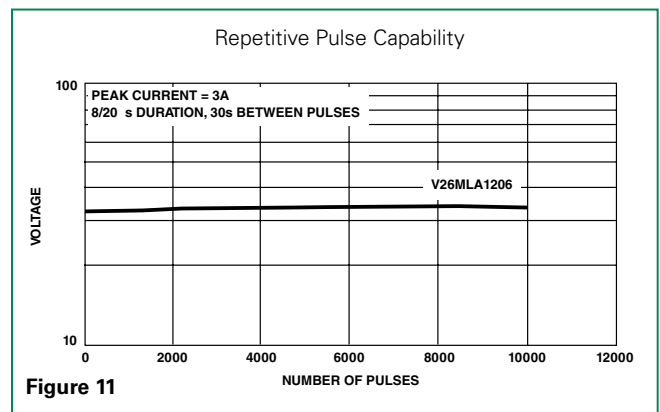

Figure 11

Lead (Pb) Soldering Recommendations

The principal techniques used for the soldering of components in surface mount technology are IR Re-flow and Wave soldering. Typical profiles are shown on the right.

The recommended solder for the MLA Automotive Series suppressor is a 62/36/2 (Sn/Pb/Ag), 60/40 (Sn/Pb) or 63/37 (Sn/Pb). Littelfuse also recommends an RMA solder flux.

Wave soldering is the most strenuous of the processes. To avoid the possibility of generating stresses due to thermal shock, a preheat stage in the soldering process is recommended, and the peak temperature of the solder process should be rigidly controlled.

When using a reflow process, care should be taken to ensure that the MLA Automotive Series chip is not subjected to a thermal gradient steeper than 4 degrees per second; the ideal gradient being 2 degrees per second. During the soldering process, preheating to within 100 degrees of the solder's peak temperature is essential to minimize thermal shock.

Once the soldering process has been completed, it is still necessary to ensure that any further thermal shocks are avoided. One possible cause of thermal shock is hot printed circuit boards being removed from the solder process and subjected to cleaning solvents at room temperature. The boards must be allowed to cool gradually to less than 50° C before cleaning.

Reflow Solder Profile

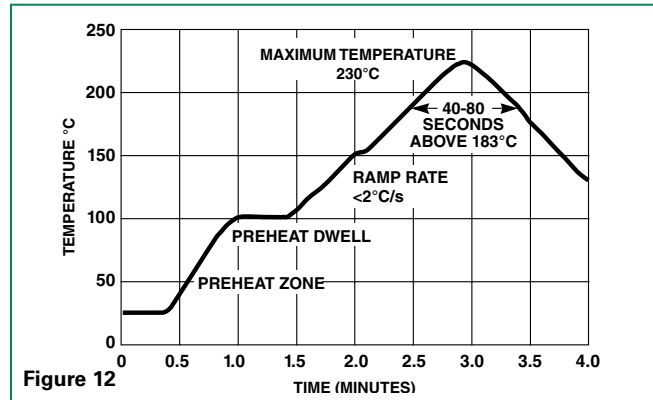

Wave Solder Profile

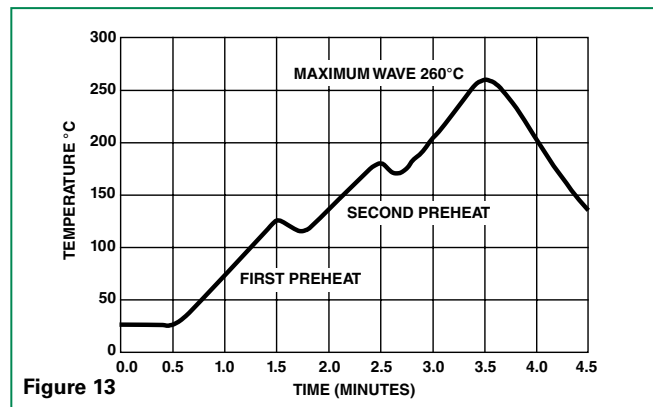

Lead-free (Pb-free) Soldering Recommendations

Littelfuse offers the Nickel Barrier Termination option (see "N" suffix in Part Numbering System for ordering) for the optimum Lead-free solder performance, consisting of a Matte Tin outer surface plated on Nickel underlayer, plated on Silver base metal.

The preferred solder is 96.5/3.0/0.5 (SnAgCu) with an RMA flux, but there is a wide selection of pastes and fluxes available with which the Nickel Barrier parts should be compatible.

The reflow profile must be constrained by the maximums in the Lead-free Reflow Profile. For Lead-free wave soldering, the Wave Solder Profile still applies.

Note: the Lead-free paste, flux and profile were used for evaluation purposes by Littelfuse, based upon industry standards and practices. There are multiple choices of all three available, it is advised that the customer explores the optimum combination for their process as processes vary considerably from site to site.

Lead-free Re-flow Solder Profile

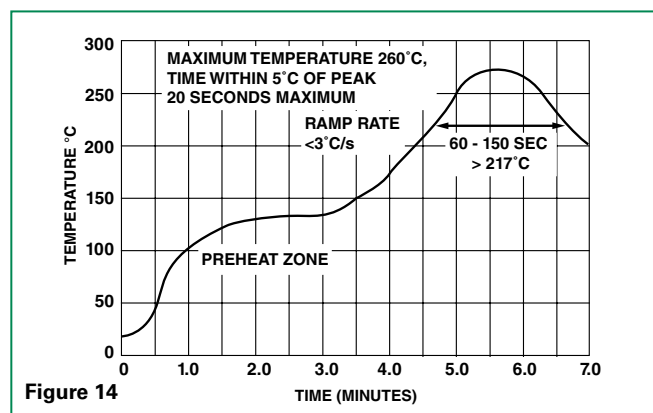

Product Dimensions (mm)

PAD LAYOUT DIMENSIONS

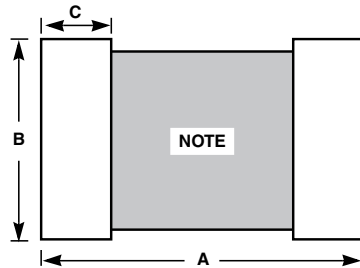

CHIP LAYOUT DIMENSIONS

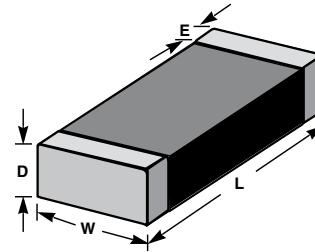

NOTE : Avoid metal runs in this area, parts not recommended for use in applications using Silver (Ag) epoxy paste.

Dimension	1210 Size		1206 Size		0805 Size		0603 Size	
	IN	MM	IN	MM	IN	MM	IN	MM
A	0.160	4.06	0.160	4.06	0.120	3.05	0.100	2.54
B	0.100	2.54	0.065	1.65	0.050	1.27	0.030	0.76
C	0.040	1.02	0.040	1.02	0.040	1.02	0.035	0.89
D (max.)	0.113	2.87	0.071	1.80	0.043	1.10	0.040	1.00
E	0.020 -/+0.010	0.50 -/+0.25	0.020 -/+0.010	0.50 -/+0.25	0.020 +/- 0.010	0.50 +/- 0.25	0.015 -/+0.008	0.4 -/+0.20
L	0.125 -/+0.012	3.20 -/+0.30	0.125 -/+0.012	3.20 -/+0.30	0.079 -/+0.008	2.01 -/+0.20	0.063 -/+0.006	1.6 -/+0.15
W	0.100 -/+0.012	2.54 -/+0.30	0.060 -/+0.011	1.60 -/+0.28	0.049 -/+0.008	1.25 -/+0.20	0.032 -/+0.060	0.8 -/+0.15

Part Numbering System

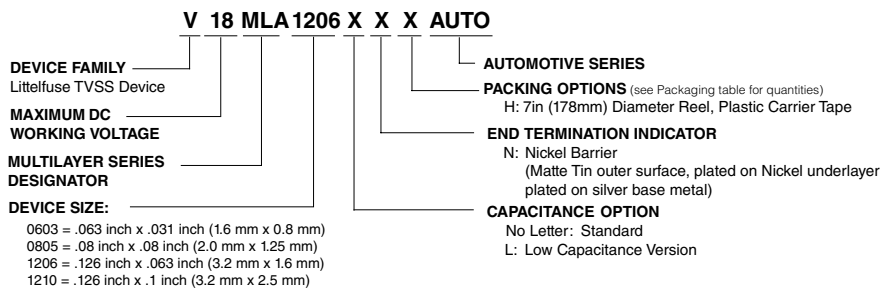

Packaging*

Device Size	Quantity
	7" Inch Reel ("H" Option)
1210	2,000
1206	2,500
0805	2,500
0603	2,500

*(Packaging) It is recommended that parts be kept in the sealed bag provided and that parts be used as soon as possible when removed from bags.

Tape and Reel Specifications

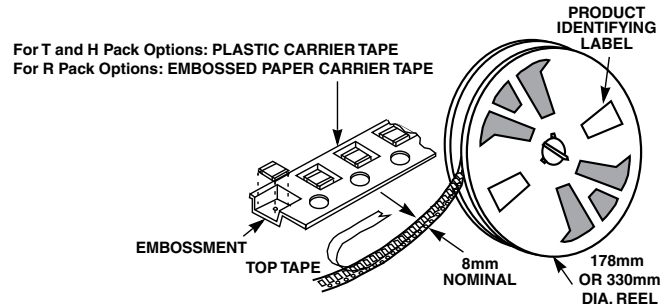
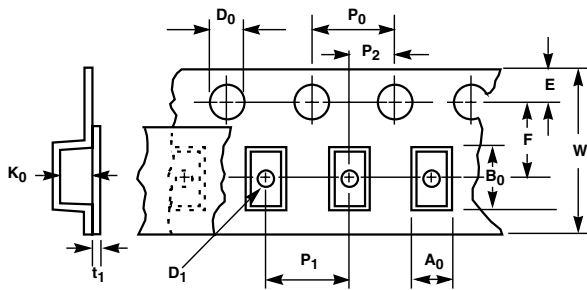

Symbol	Description	Dimensions in Millimeters
		0603, 0805, 1206 & 1210 Sizes
A₀	Width of Cavity	Dependent on Chip Size to Minimize Rotation.
B₀	Length of Cavity	Dependent on Chip Size to Minimize Rotation.
K₀	Depth of Cavity	Dependent on Chip Size to Minimize Rotation.
W	Width of Tape	8 -/+0.3
F	Distance Between Drive Hole Centers and Cavity Centers	3.5 -/+0.05
E	Distance Between Drive Hole Centers and Tape Edge	1.75 -/+0.1
P₁	Distance Between Cavity Centers	4 -/+0.1
P₂	Axial Drive Distance Between Drive Hole Centers & Cavity Centers	2 -/+0.1
P₀	Axial Drive Distance Between Drive Hole Centers	4 -/+0.1
D₀	Drive Hole Diameter	1.55 -/+0.05
D₁	Diameter of Cavity Piercing	1.05 -/+0.05
T₁	Top Tape Thickness	0.1 Max

NOTES:
 • Conforms to EIA-481-1, Revision A
 • Can be supplied to IEC publication 286-3

Disclaimer Notice - Information furnished is believed to be accurate and reliable. However, users should independently evaluate the suitability of and test each product selected for their own applications. Littelfuse products are not designed for, and may not be used in, all applications. Read complete Disclaimer Notice at www.littelfuse.com/disclaimer-electronics.

AUML Varistor Series

RoHS

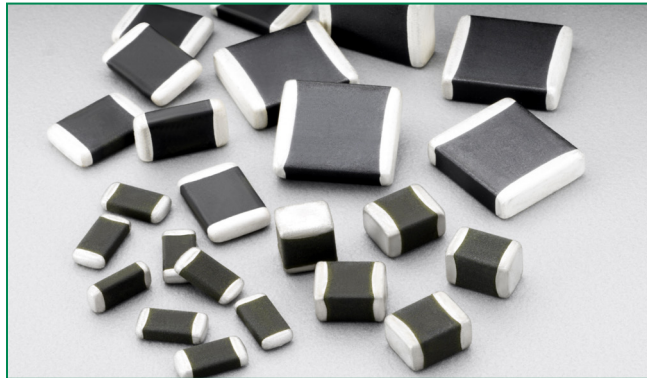

Size Table

Metric	EIA
3216	1206
3225	1210
4532	1812
5650	2220

Applications

- Suppression of inductive switching or other transient events such as EFT and surge voltage at the circuit board level
- ESD protection for components sensitive to IEC 61000-4-2 (Level 4), MIL-STD-883C, Method 3015.7, and other industry specifications (See Also the MLE or MLN Series)
- Provides on-board transient voltage protection for ICs and transistors
- Used to help achieve electromagnetic compliance of end products
- Replace larger surface mount TVS Zeners in many applications

Description

The AUML Series of Multilayer Transient Surge Suppressors was specifically designed to suppress the destructive transient voltages found in an automobile. The most common transient condition results from large inductive energy discharges. The electronic systems in the automobile, e.g. antilock brake systems, direct ignition systems, engine control, airbag control systems, wiper motor controls, etc., are susceptible to damage from these voltage transients and thus require protection. The AUML transient suppressors have temperature independent suppression characteristics affording protection from -55°C to 125°C.

The AUML suppressor is manufactured from semiconducting ceramics which offer rugged protection and excellent transient energy absorption in a small package. The devices are available in ceramic leadless chip form, eliminating lead inductance and assuring fast speed of response to transient surges. These Suppressors require significantly smaller space and land pads than Silicon TVS diodes, offering greater circuit board layout flexibility for the designer.

Also see the Littelfuse ML, MLN and MLE Series of Multilayer Suppressors.

Features

- AEC - Q200 compliant
- RoHS Compliant
- Load Dump energy rated per SAE Specification J1113
- Leadless, surface mount chip form
- "Zero" Lead Inductance
- Variety of energy ratings available
- No temperature derating up to 125°C ambient
- High peak surge current capability
- Low Profile, compact industry standard chip size; (1206, 1210, 1812 and 2220 Sizes)
- Inherent bidirectional clamping
- No Plastic or epoxy packaging assures better than 94V-0 flammability rating

Absolute Maximum Ratings

• For ratings of individual members of a series, see Device Ratings and Specifications chart.

Continuous	AUML Series	Units
Steady State Applied Voltage:		
DC Voltage Range (V_{MIDC})	18, 24, 48, 68	V
Transient:		
Load Dump Energy, (W_{LD})	1.5 to 25	J
Jump Start Capability (5 minutes), (V_{JUMP})	48	V
Operating Ambient Temperature Range (T_A)	-55 to +125	°C
Storage Temperature Range (T_{STG})	-55 to +150	°C
Temperature Coefficient (αV) of Clamping Voltage (V_C) at Specified Test Current	<0.01	%/°C

CAUTION: Stresses above those listed in "Absolute Maximum Ratings" may cause permanent damage to the device. This is a stress only rating and operation of the device at these or any other conditions above those indicated in the operational sections of this specification is not implied.

Device Ratings and Specifications

Part Number	Maximum Ratings (125°C)			Specifications (25°C)				
	Maximum Continuous DC Voltage	Jump Start Voltage (5 Min)	Load Dump Energy (10 Pulses)	Nominal Varistor Voltage at 10mA DC Test Current		Maximum Standby Leakage (at 13V DC)	Maximum Clamping Voltage (V _C) at Test Current (8/20μs)	
	V _{M(DC)} (V)	V _{JUMP} (V)	W _{LD} (J)	V _{N(DC)} Min (V)	V _{N(DC)} Max (V)	I _L (μA)	V _C (V)	I _P (A)
V18AUMLA1206	18	24.5	1.5	23	32	50	40	1.5
V18AUMLA1210	18	24.5	3.0	23	32	50	40	1.5
V18AUMLA1812	18	24.5	6.0	23	32	100	40	5.0
V18AUMLA2220	18	24.5	25	23	32	200	40	10.0
V24AUMLA2220	24	24.5	25	32	39	200	60	10.0
V48AUMLA2220	48	24.5	25	54.5	66.5	200	105	10.0
V68AUMLA2220	68	24.5	25	77.2	94.4	200	135	10.0

NOTES: 1. Average power dissipation of transients not to exceed 0.1W, 0.15W, 0.3W and 1W for model sizes 1206, 1210, 1812 and 2220 respectively.
 2. Load dump :min. time of energy input 40ms, interval 60sec(the load dump time constant Td differs from the time constant of energy input; load dump rating for ISO 7637-2 pulse 5a, please contact littelfuse.
 3. Thermal shock capability per Mil-Std-750, Method 1051: -55°C to 125°C, 5 minutes at 25°C, 25 Cycles: 15 minutes at each extreme.
 4. For application specific requirements, please contact Littelfuse.

Current, Energy and Power Derating Curve

When transients occur in rapid succession, the average power dissipation is the energy (watt-seconds) per pulse times the number of pulses per second. The power so developed must be within the specifications shown on the Device Ratings and Characteristics Table for the specific device. Certain parameter ratings must be derated at high temperatures as shown below.

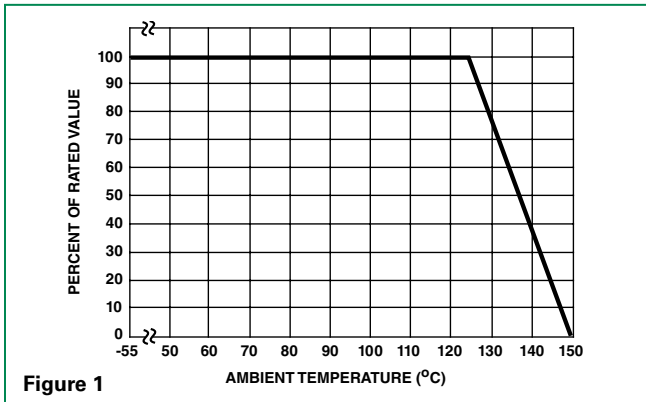

Peak Pulse Current Test Waveform for Clamping Voltage

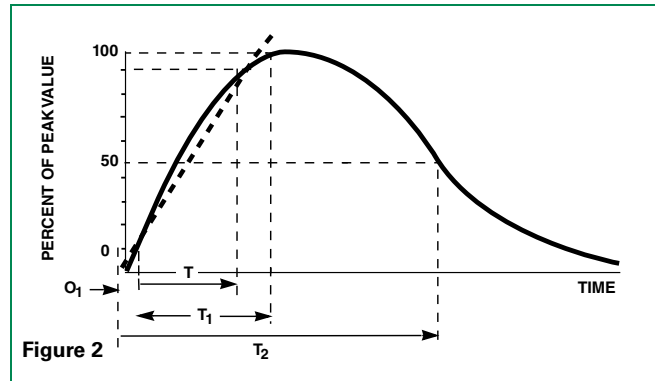

O₁ = Virtual Origin of Wave
 T = Time from 10% to 90% of Peak
 T₁ = Rise Time = 1.25 x T
 T₂ = Decay Time
Example - For an 8/20 μs Current Waveform:
 8 μs = T₁ = Rise Time
 20 μs = T₂ = Decay Time

Maximum Leakage Current/Clamping Voltage Curve for AUML Series at 25°C

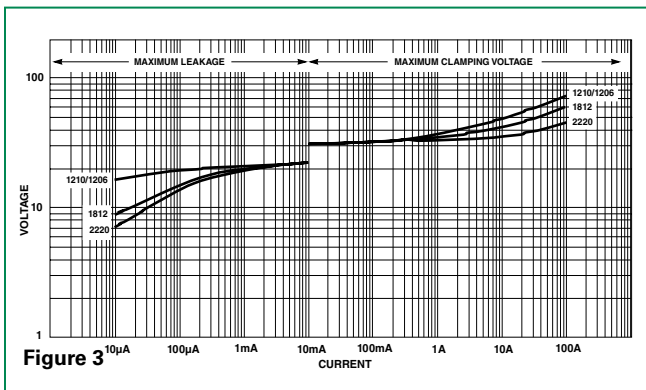

Typical V-I Characteristics of the V18AUMLA2220 at -40°C, 25°C, 85°C and 125°C

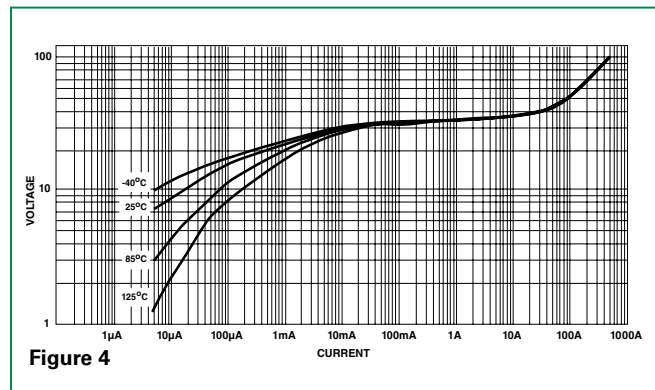

Temperature Effects

In the leakage region of the AUML suppressor, the device characteristics approaches a linear (ohmic) relationship and shows a temperature dependent affect. In this region the suppressor is in a high resistance mode (approaching $10^6\Omega$) and appears as a near open-circuit. Leakage currents at maximum rated voltage are in the microamp range.

When clamping transients at higher currents (at and above the 10mA range), the AUML suppressor approaches a 1-10 characteristic. In this region the characteristics of the AUML are virtually temperature independent. Figure 3 shows the typical effect of temperature on the V-I characteristics of the AUML suppressor.

Load Dump Energy Capability

A Load Dump transient occurs when the alternator load in the automobile is abruptly reduced. The worst case scenario of this transient occurs when the battery is disconnected while operating at full rated load. There are a number of different Load Dump specifications in existence in the automotive industry, with the most common one being that recommended by the Society of Automotive Engineers, specification #SAE J1113. Because of the diversity of these Load Dump specifications Littelfuse defines the Load Dump energy capability of the AUML suppressor range as that energy dissipated by the device itself, independent of the test circuit setup. The resultant Load Dump energy handling capability serves as an excellent figure of merit for the AUML suppressor. Standard Load Dump specifications require a device capability of 10 pulses at rated energy, across a temperature range of -40°C to $+125^\circ\text{C}$. This capability requirement is well within the ratings of all of the AUML Series (Figure 6 on next page).

The very high energy absorption capability of the AUML suppressor is achieved by means of a highly controlled manufacturing process. This technology ensures that a large volume of suppressor material, with an interdigitated layer construction, is available for energy absorption in an extremely small package. Unlike equivalent rated Silicon TVS diodes, the entire AUML device volume is available to dissipate the Load Dump energy.

Hence, the peak temperatures generated by the Load Dump transient are significantly lower and evenly dissipated throughout the complete device (Figure 5 below). This even energy dissipation ensures that there are lower peak temperatures generated at the P-N grain boundaries of the AUML suppressor.

There are a number of different size devices available in the AUML Series, each one with a load dump energy rating, which is size dependent.

Speed of Response

The clamping action of the AUML suppressor depends on a conduction mechanism similar to that of other semiconductor devices (i.e. P-N Junctions). The apparent slow response time often associated with transient voltage suppressors (Zeners, MOVs) is often due to parasitic inductance in the package and leads of the device and less dependent of the basic material (Silicon, $Z_{\text{N}}\text{O}$). Thus, the single most critical element affecting the response time of any suppressor is its lead inductance. The AUML suppressor is a surface mount device, with no leads or external packaging, and thus, it has virtually zero inductance. The actual response time of a AUML surge suppressor is in the 1 to 5 ns range, more than sufficient for the transients which are likely to be encountered in an automotive environment.

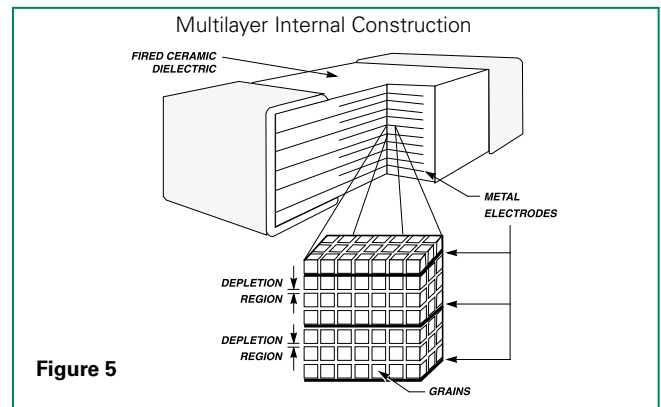

Figure 5

AUML Load Dump Pulsing over a Temperature Range of -55°C to $+125^\circ\text{C}$

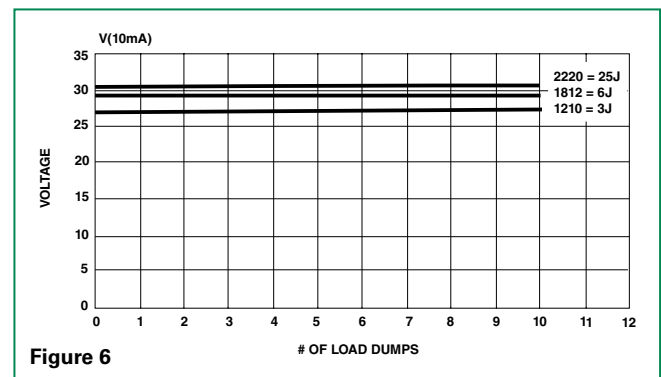

Figure 6

Explanation of Terms

Maximum Continuous DC Working Voltage ($V_{M*(DC)+}$)

This is the maximum continuous DC voltage which may be applied, up to the maximum operating temperature (125°C), to the ML suppressor. This voltage is used as the reference test point for leakage current and is always less than the breakdown voltage of the device.

Load Dump Energy Rating W_{LD+}

This is the actual energy the part is rated to dissipate under Load Dump conditions (not to be confused with the "source energy" of a Load Dump test specification).

Maximum Clamping Voltage V_{C+}

This is the peak voltage appearing across the suppressor when measured at conditions of specified pulse current and specified waveform (8/20 μ s). It is important to note that the peak current and peak voltage may not necessarily be coincidental in time.

Leakage Current I_{L+}

In the nonconducting mode, the device is at a very high impedance (approaching 10⁶ Ω at its rated working voltage) and appears as an almost open circuit in the system. The leakage current drawn at this level is very low (<25 μ A at ambient temperature) and, unlike the Zener diode, the multilayer TVS has the added advantage that, when operated up to its maximum temperature, its leakage current will not increase above 500 μ A.

Nominal Voltage V_{NDC+}

This is the voltage at which the AUML enters its conduction state and begins to suppress transients. In the automotive environment this voltage is defined at the 10mA point and has a minimum ($V_{NDC\ MIN}$) and maximum ($V_{NDC\ MAX}$) voltage specified.

Additional Information



Datasheet



Resources



Samples

Lead (Pb) Soldering Recommendations

The principal techniques used for the soldering of components in surface mount technology are IR Re-flow and Wave soldering. Typical profiles are shown on the right.

The termination option available for each solder technique is:

- | | |
|-------------------------------|-------------------------------|
| Reflow | Wave |
| 1. Nickel Barrier (preferred) | 1. Nickel Barrier (preferred) |
| 2. Silver/Platinum | |

The recommended solder for the AURL suppressor is a 62/36/2 (Sn/Pb/Ag), 60/40 (Sn/Pb) or 63/37 (Sn/Pb). Littelfuse also recommends an RMA solder flux.

Wave soldering is the most strenuous of the processes. To avoid the possibility of generating stresses due to thermal shock, a preheat stage in the soldering process is recommended, and the peak temperature of the solder process should be rigidly controlled.

When using a reflow process, care should be taken to ensure that the AURL chip is not subjected to a thermal gradient steeper than 4 degrees per second; the ideal gradient being 2 degrees per second. During the soldering process, preheating to within 100 degrees of the solder's peak temperature is essential to minimize thermal shock.

Once the soldering process has been completed, it is still necessary to ensure that any further thermal shocks are avoided. One possible cause of thermal shock is hot printed circuit boards being removed from the solder process and subjected to cleaning solvents at room temperature. The boards must be allowed to cool gradually to less than 50°C before cleaning.

Reflow Solder Profile

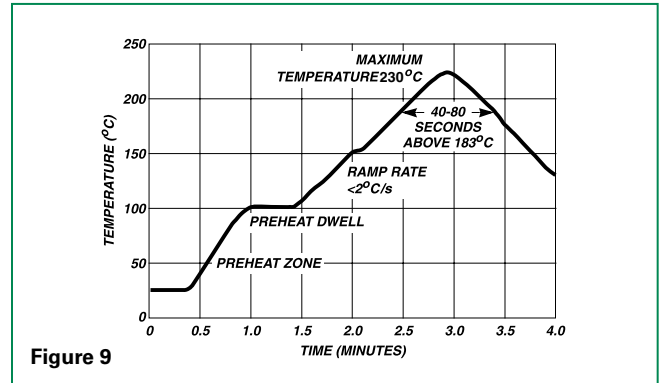

Figure 9

Wave Solder Profile

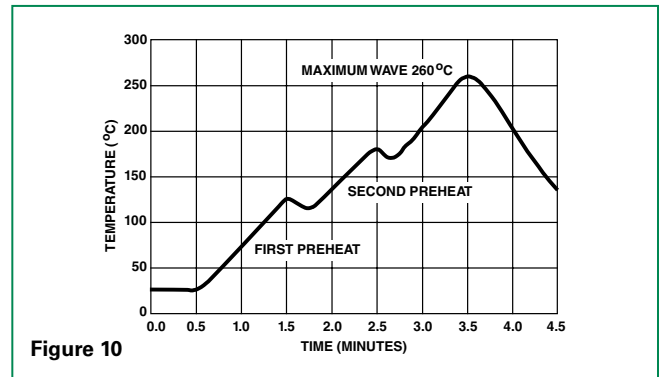

Figure 10

Lead-free (Pb-free) Soldering Recommendations

Littelfuse offers the Nickel Barrier Termination finish for the optimum Lead-free solder performance.

The preferred solder is 96.5/3.0/0.5 (SnAgCu) with an RMA flux, but there is a wide selection of pastes and fluxes available with which the Nickel Barrier parts should be compatible.

The reflow profile must be constrained by the maximums in the Lead-free Reflow Profile. For Lead-free Wave soldering, the Wave Solder Profile still applies.

Note: the Lead-free paste, flux and profile were used for evaluation purposes by Littelfuse, based upon industry standards and practices. There are multiple choices of all three available, it is advised that the customer explores the optimum combination for their process as processes vary considerably from site to site.

Lead-free Re-flow Solder Profile

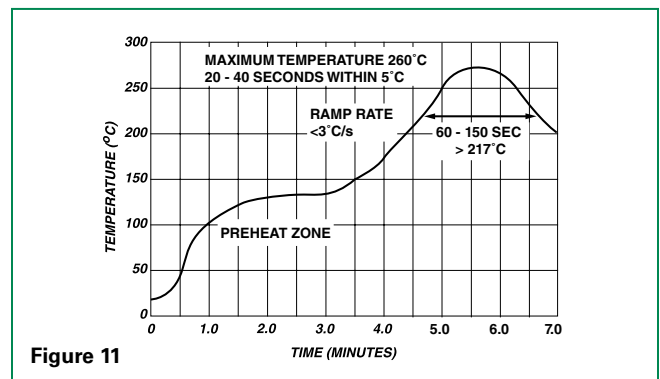
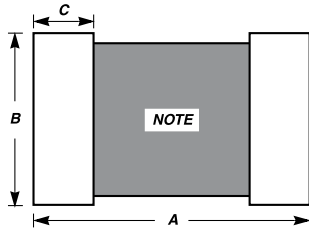

Figure 11

Product Dimensions (mm)

PAD LAYOUT DIMENSIONS



Note: Avoid metal runs in this area, parts are not recommended for use in applications using Silver (Ag) epoxy paste.

CHIP LAYOUT DIMENSIONS

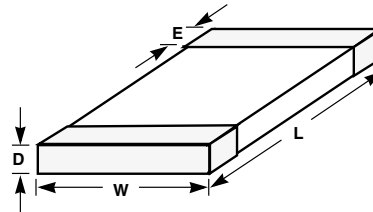

SYMBOL	1206 Size		1210 Size		1812 Size		2220 Size	
	IN	MM	IN	MM	IN	MM	IN	MM
A	0.203	5.150	0.219	5.510	0.272	6.910	0.315	8.000
B	0.103	2.620	0.147	3.730	0.172	4.360	0.240	6.190
C	0.065	1.650	0.073	1.850	0.073	1.850	0.073	1.850
D (max.)	0.071	1.80	0.070	1.80	0.07	1.80	0.118	3.00
E	0.020 +/- 0.010	0.50 +/- 0.25	0.020 +/- 0.010	0.50 +/- 0.25	0.020 +/- 0.010	0.50 +/- 0.25	0.030 +/- 0.010	0.75 +/- 0.25
L	0.125 +/- 0.012	3.20 +/- 0.03	0.125 +/- 0.012	3.20 +/- 0.30	0.180 +/- 0.014	4.50 +/- 0.35	0.225 +/- 0.016	5.70 +/- 0.40
W	0.060 +/- 0.011	1.60 +/- 0.28	0.100 +/- 0.012	2.54 +/- 0.30	0.125 +/- 0.012	3.20 +/- 0.30	0.197 +/- 0.016	5.00 +/- 0.40

Part Numbering System

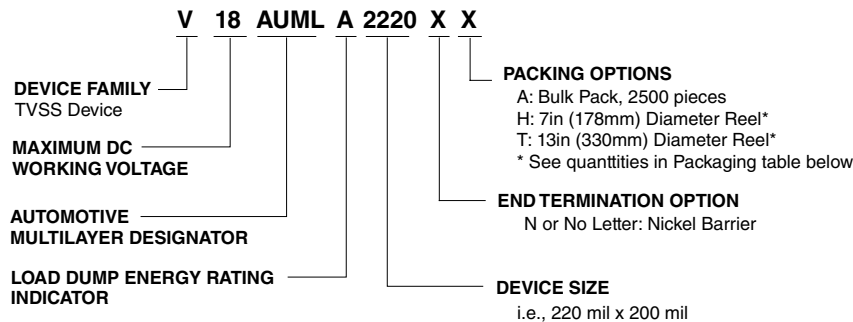

Packaging*

Device Size	Quantity		
	13" Inch Reel ('T' Option)	7" Inch Reel ('H' Option)	Bulk Pack ('A' Option)
1206	10,000	2,500	2,500
1210	8,000	2,000	2,000
1812	4,000	1,000	1,000
2220	4,000	1,000	1,000

*(Packaging) It is recommended that parts be kept in the sealed bag provided and that parts be used as soon as possible when removed from bags.

Tape and Reel Specifications

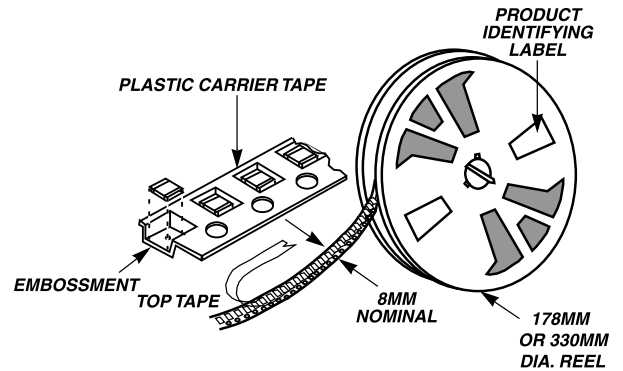
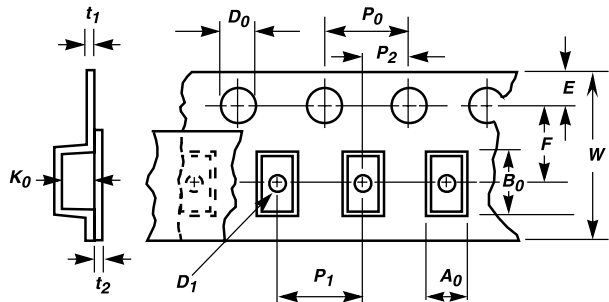

Symbol	Description	Dimensions in Millimeters	
A_0	Width of Cavity	Dependent on Chip Size to Minimize Rotation.	
B_0	Length of Cavity	Dependent on Chip Size to Minimize Rotation.	
K_0	Depth of Cavity	Dependent on Chip Size to Minimize Rotation.	
W	Width of Tape	8 \pm 0.2	12 \pm 0.2
F	Distance Between Drive Hole Centers and Cavity Centers	3.5 \pm 0.5	5.4 \pm 0.5
E	Distance Between Drive Hole Centers and Tape Edge	1.75 \pm 0.1	1.75 \pm 0.1
P_1	Distance Between Cavity Center	4 \pm 0.1	8 \pm 0.1
P_2	Axial Distance Between Drive Hole Centers and Cavity Centers	2 \pm 0.1	2 \pm 0.1
P_0	Axial Distance Between Drive Hole Centers	8 \pm 0.1	8 \pm 0.1
D_0	Drive Hole Diameter	1.55 \pm 0.05	1.55 \pm 0.05
D_1	Diameter of Cavity Piercing	1.05 \pm 0.05	1.55 \pm 0.05
T_1	Embossed Tape Thickness	0.3 Max	0.4 Max
T_2	Top Tape Thickness	0.1 Max	0.1 Max

NOTE: Dimensions in millimeters.

- Conforms to EIA-481-1, Revision A
- Can be supplied to IEC publication 286-3

Tape	8mm Wide Tape		12mm Wide Tape	
Chip Size	1206	1210	1812	2220

Standard Packaging

Tape and reel is the standard packaging method of the AUML Series. The standard 300 millimeter (13-inch) reel utilized contains 4000 pieces for the 2200 and 1812 chips, 8000 pieces for the 1210 chip and 10,000 pieces for the 1206 size.

To order: add 'T' to the standard part number, e.g. V18AUMLA2220T.

Special Packaging

Option1: 178 millimeter (7-inch) reels containing 1000 (2220, 1812), 2000 (1210), 2500 (1206), pieces are available. To order add 'H' to the standard part number, e.g. V18AUMLA2220H.

Option 2 For small sample quantities (less than 100 pieces) the units are shipped bulk pack. To order add 'A' to the standard part number, e.g. V18AUMLA2220A.

Disclaimer Notice - Information furnished is believed to be accurate and reliable. However, users should independently evaluate the suitability of and test each product selected for their own applications. Littelfuse products are not designed for, and may not be used in, all applications. Read complete Disclaimer Notice at www.littelfuse.com/disclaimer-electronics.

MLN SurgeArray™ Suppressor

RoHS



Size Table

Metric	EIA
3216	1206

Absolute Maximum Ratings

Continuous	MLN Series	Units
Steady State Applied Voltage:		
DC Voltage Range (V_{MDC})	5.5 - 18	V
Operating Ambient Temperature Range (T_A)	-55 to +125	°C
Storage Temperature Range (T_{STG})	-55 to +150	°C

For ratings of individual members of a series, see device ratings and specifications table.

Additional Information



Datasheet



Resources



Samples

Description

The MLN SurgeArray™ Suppressor is designed to help protect components from transient voltages that exist at the circuit board level. This device provides four independent suppressors in a single leadless chip in order to reduce part count and placement time as well as save space on printed circuit boards.

SurgeArray™ Suppressor are intended to suppress ESD, EFT and other transients in order to protect integrated circuits or other sensitive components operating at any voltage up to $18V_{DC}$. SurgeArray™ Suppressor are rated to the IEC 61000-4-2 human body model ESD to help products attain EMC compliance. The array offers excellent isolation and low crosstalk between sections.

The inherent capacitance of the SurgeArray™ Suppressor permits it to function as a filter/suppressor, thereby replacing separate Zener/capacitor combinations.

The MLN array is manufactured using the Littelfuse Multilayer technology process and is similar to the Littelfuse ML and MLE Series of discrete leadless chips.

Features

- RoHS Compliant
- Four individual devices in one chip
- ESD rated to IEC 61000-4-2 (Level 4)
- AC characterized for impedance and capacitance
- Low adjacent channel crosstalk, -55dB at 10MHz (Typ)
- Low leakage
- Operating voltage up to $18V_{MDC}$
- -55°C to 125°C operating temp range
- Low-profile, PCMCIA compatible

Applications

- Data, Diagnostic I/O Ports
- Analog Signal/Sensor Lines
- Portable/Hand-Held Products
- Mobile
- Communications/Cellular Phones
- Computer/DSP Products
- Industrial Instruments Including Medical

Device Ratings and Specifications Any Single Section

Part Number	Maximum Ratings (125°C)			Specifications (25°C)							
	Maximum Continuous Working Voltage	Maximum Non-repetitive Surge Current (8/20 μ s)	Maximum Non-repetitive Surge Energy (10/1000 μ s)	Maximum Clamping Voltage (at Noted 8/20 μ s) Current	Typical ESD Suppression Voltage (Note1)			Nominal Voltage at 1 mA DC Test Current		Capacitance at 1 MHz (1V p-p)	
	$V_{M(DC)}$	I_{TM}	W_{TM}	V_C	(Note 2) 8kV Contact		(Note 3) 15kV Air	$V_{N(DC)}$ Min	$V_{N(DC)}$ Max	(Note 4) C	
					Peak	Clamp	Peak			TYP	MAX
(V)	(A)	(J)	(V)	(V)	(V)	(V)	(V)	(V)	(pF)	(pF)	
V5.5MLN41206	5.5	30	0.10	15.5 at 2A	60	35	45	7.10	10.8	430	520
V9MLN41206	9.0	30	0.10	23.0 at 2A	95	50	75	11.0	16.0	250	300
V14MLN41206	14.0	30	0.10	30.0 at 2A	110	55	85	15.9	20.3	140	175
V18MLN41206	18.0	30	0.10	40.0 at 2A	165	63	100	22.0	28.0	100	125
V18MLN41206L	18.0	30	0.05	50.0 at 1A	200	95	130	25.0	35.0	45	75

NOTES: 1. Tested to IEC61000-4-2 Human Body Model (HBM) discharge test circuit.
 2. Direct discharge to device terminals (IEC preferred test method).
 3. Corona discharge through air (represents actual ESD event)

4. Capacitance may be customized, contact Sales.
 5. The typical capacitance rating is the discrete component test result.

Peak Current and Energy Derating Curve

For applications exceeding 125°C ambient temperature, the peak surge current and energy ratings must be reduced.

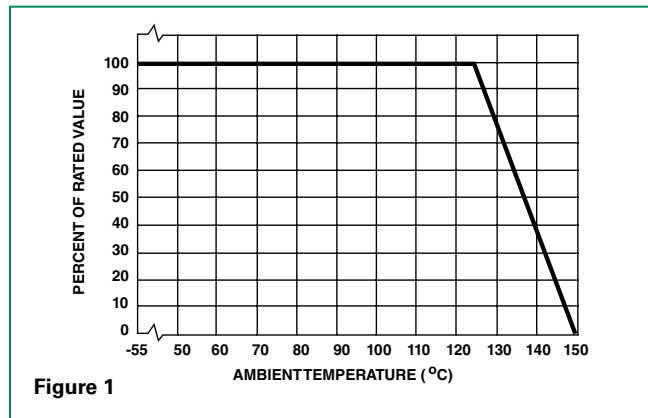

Figure 1

Peak Pulse Current Test Waveform for Clamping Voltage

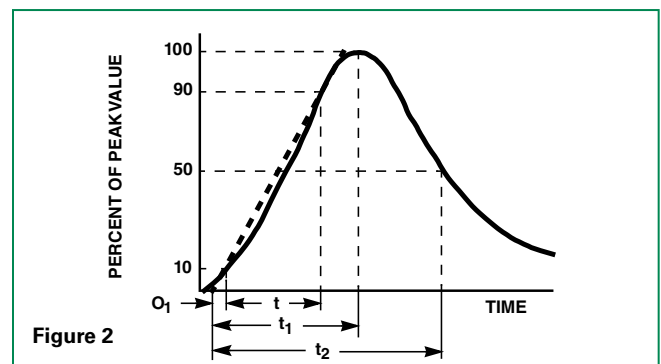

Figure 2

O_1 = Virtual Origin of Wave

T = Time from 10% to 90% of Peak

T_1 = Rise Time = $1.25 \times T$

T_2 = Decay Time

(Impulse Duration)

Example:

For an 8/20 μ s Current Waveform:

$8\mu s = T_1$ = Rise Time

$20\mu s = T_2$ = Virtual Time

to Half Value

Typical Performance Curves

Equivalent Series Resistance

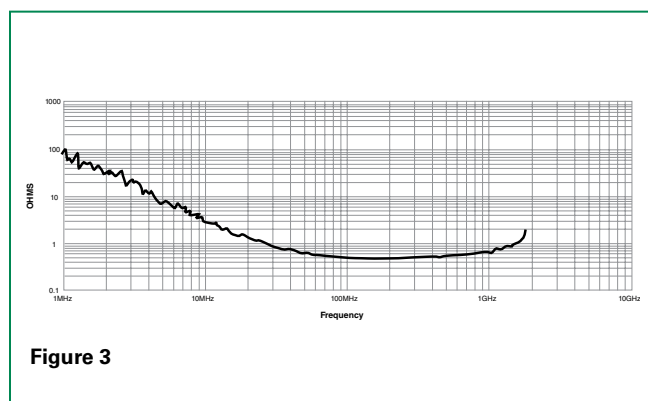

Figure 3

Impedance vs Frequency, 1206 Size

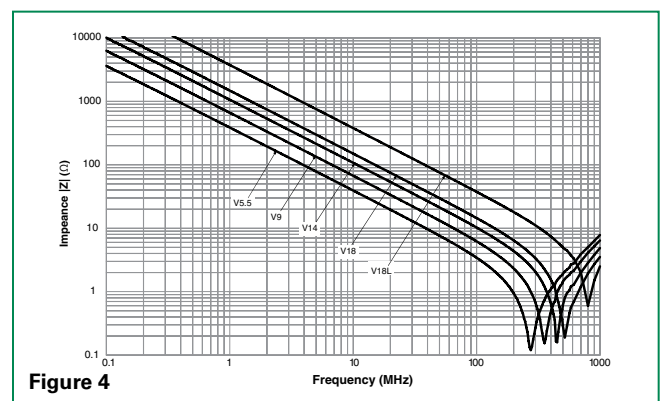

Figure 4

Typical Performance Curves (continued)

Nominal Voltage Stability to IEC 1000-4-2 (8kV Contact Method, One Section)

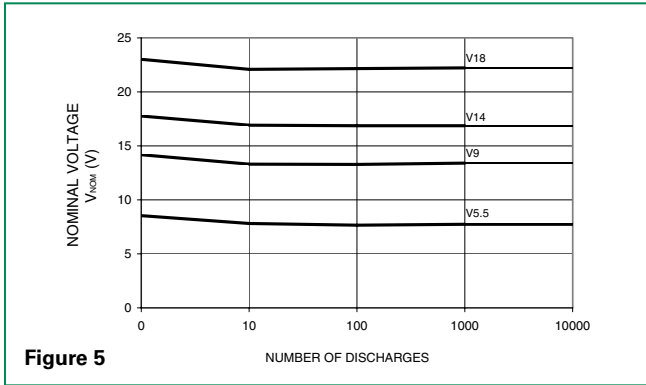

Figure 5

1206 Size Pulse Rating for Long Duration Surges (Any Single Section)

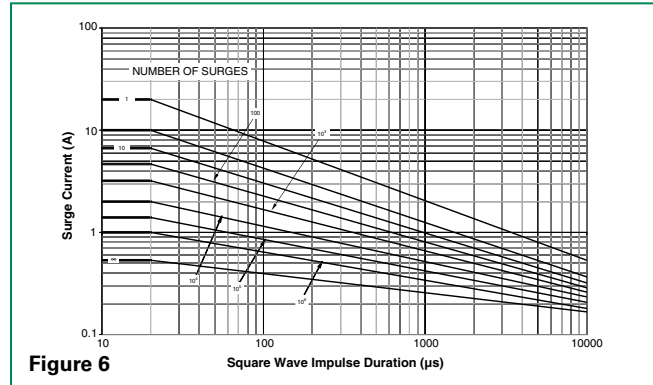

Figure 6

V-I Characteristic, 1206 size

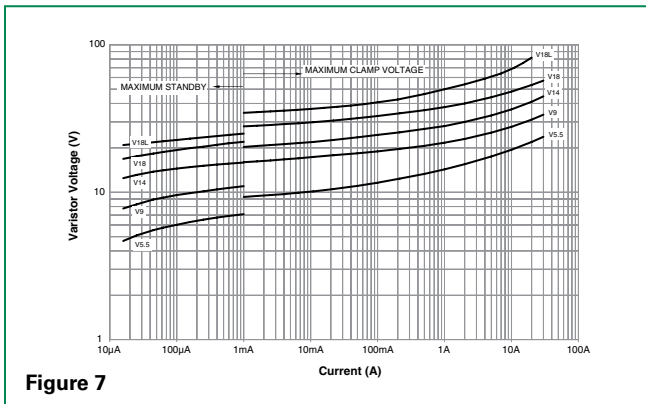

Figure 7

Capacitance vs Frequency, 1206 Size

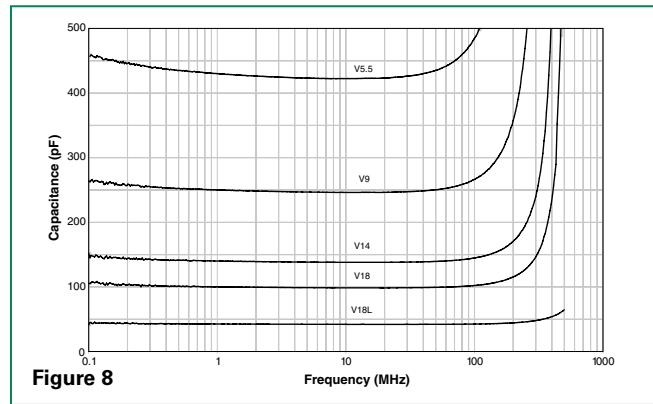

Figure 8

Adjacent Channel Crosstalk

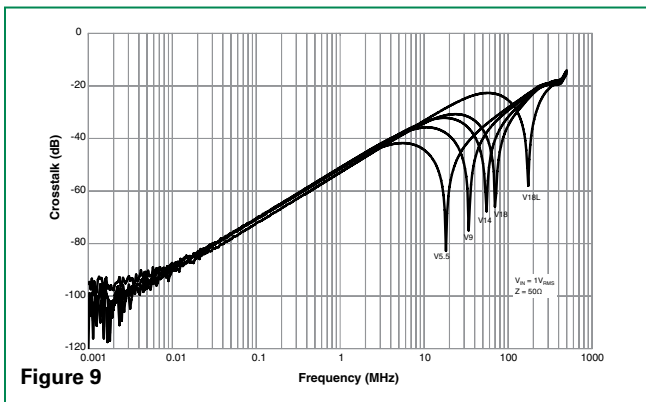

Figure 9

Lead (Pb) Soldering Recommendations

The principal techniques used for the soldering of components in surface mount technology are IR Re-flow and Wave soldering. Typical profiles are shown on the right.

The recommended solder for the MLN suppressor is a 62/36/2 (Sn/Pb/Ag), 60/40 (Sn/Pb) or 63/37 (Sn/Pb). Littelfuse also recommends an RMA solder flux.

Wave soldering is the most strenuous of the processes. To avoid the possibility of generating stresses due to thermal shock, a preheat stage in the soldering process is recommended, and the peak temperature of the solder process should be rigidly controlled.

When using a reflow process, care should be taken to ensure that the MLN chip is not subjected to a thermal gradient steeper than 4 degrees per second; the ideal gradient being 2 degrees per second. During the soldering process, preheating to within 100 degrees of the solder's peak temperature is essential to minimize thermal shock.

Once the soldering process has been completed, it is still necessary to ensure that any further thermal shocks are avoided. One possible cause of thermal shock is hot printed circuit boards being removed from the solder process and subjected to cleaning solvents at room temperature. The boards must be allowed to cool gradually to less than 50°C before cleaning.

Reflow Solder Profile

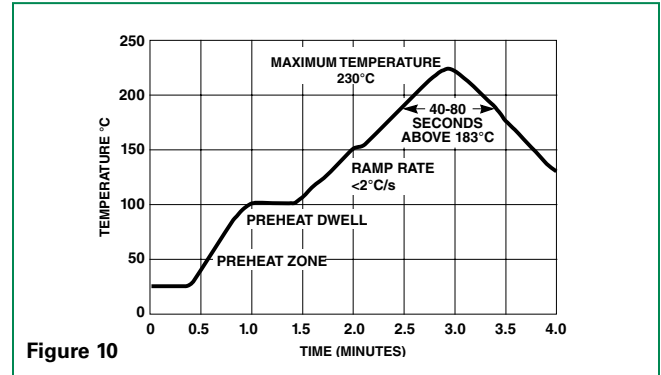

Figure 10

Wave Solder Profile

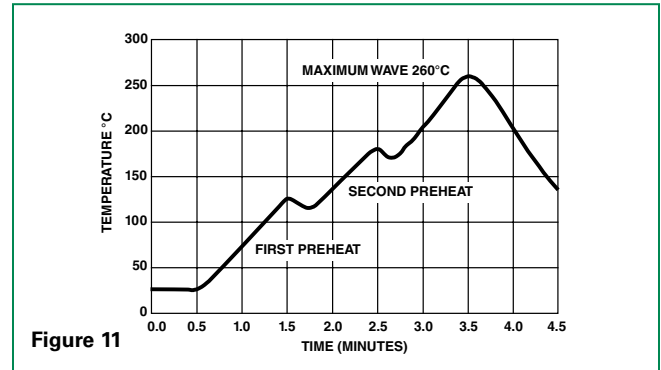
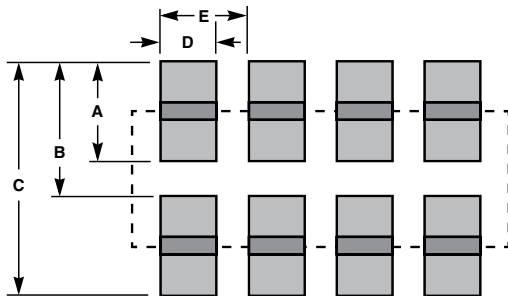

Figure 11

Product Dimensions (mm)

PAD LAYOUT DIMENSIONS



CHIP LAYOUT DIMENSIONS

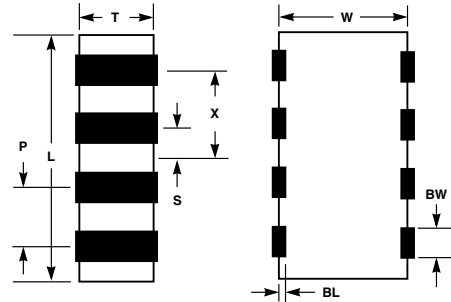

Dimension	1206 Size	
	IN	MM
A	0.035	0.890
B	0.065	1.650
C	0.100	2.540
D	0.018	0.460
E	0.030	0.790
L	3.200 +/-0.200	0.126 +/-0.008
W	1.600 +/-0.200	0.063 +/-0.008
T	1.350 Max	0.053 Max
BW	0.410 +/-0.100	0.016 +/-0.004
BL	0.180 +0.25/-0.050	0.007 +0.01/- 0.002
P	0.760 Ref	0.030 Ref
X	1.140 +/-0.100	0.045 +/-0.004
S	0.380 +/-0.100	0.015 +/-0.004

Part Numbering System

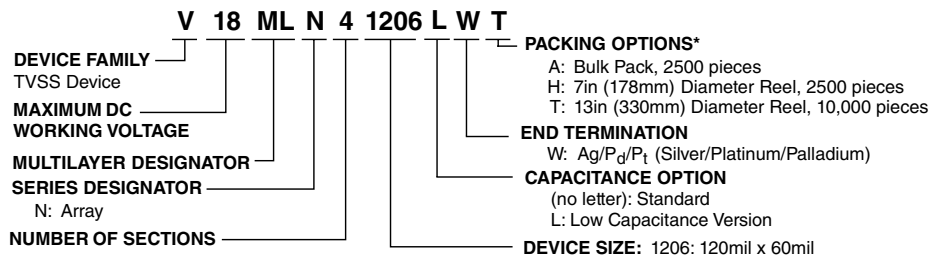

Packaging*

Device Size	Quantity		
	13" Inch Reel ("T" Option)	7" Inch Reel ("H" Option)	Bulk Pack ("A" Option)
1206	10,000	2,500	2,500

*(Packaging) It is recommended that parts be kept in the sealed bag provided and that parts be used as soon as possible when removed from bags.

Tape and Reel Specifications

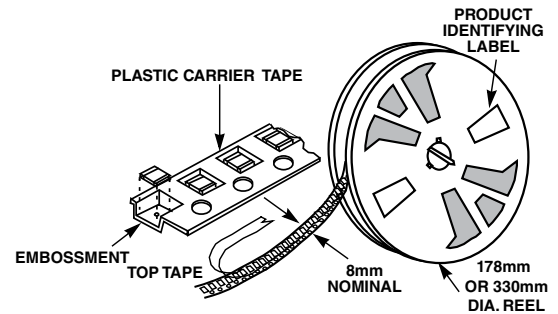
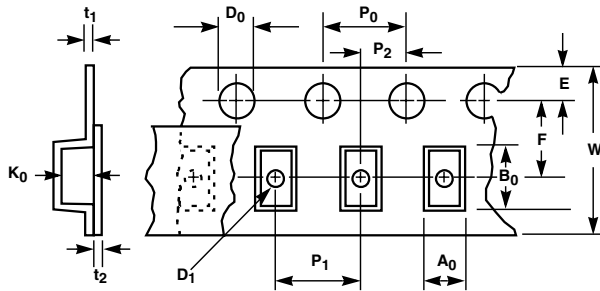

Symbol	Description	Dimensions in Millimeters
A_0	Width of Cavity	Dependent on Chip Size to Minimize Rotation.
B_0	Length of Cavity	Dependent on Chip Size to Minimize Rotation.
K_0	Depth of Cavity	Dependent on Chip Size to Minimize Rotation.
W	Width of Tape	8 -/+0.2
F	Distance Between Drive Hole Centers and Cavity Centers	3.5 -/+0.5
E	Distance Between Drive Hole Centers and Tape Edge	1.75 -/+0.1
P_1	Distance Between Cavity Center	4 -/+0.1
P_2	Axial Distance Between Drive Hole Centers and Cavity Centers	2 -/+0.1
P_0	Axial Distance Between Drive Hole Centers	4 -/+0.1
D_0	Drive Hole Diameter	1.55 -/+0.05
D_1	Diameter of Cavity Piercing	1.05 -/+0.05
T_1	Embossed Tape Thickness	0.3 Max
T_2	Top Tape Thickness	0.1 Max

Notes :

- Conforms to EIA-481-1, Revision A
- Can be supplied to IEC publication 286-3

Disclaimer Notice - Information furnished is believed to be accurate and reliable. However, users should independently evaluate the suitability of and test each product selected for their own applications. Littelfuse products are not designed for, and may not be used in, all applications. Read complete Disclaimer Notice at www.littelfuse.com/disclaimer-electronics.

CH Varistor Series

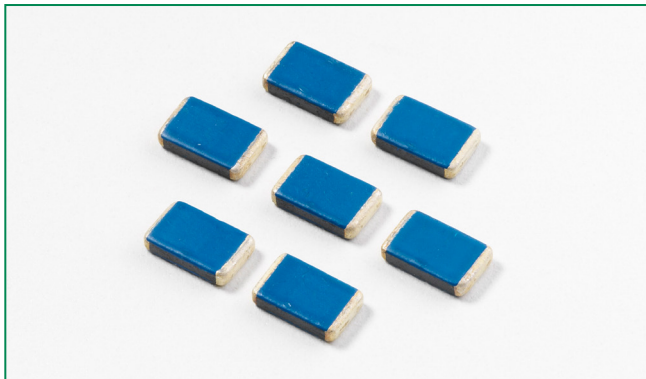

Description

CH Series transient surge suppressors are small, metal-oxide varistors (MOVs) manufactured in leadless chip form. They are intended for use in a variety of applications from low voltage DC to off-line board-level protection. These devices, which have significantly lower profiles than traditional radial lead varistors, permit designers to reduce the size and weight and increase the reliability of their equipment designs.

CH Series varistors are available in a voltage range from 14V to 275V ($V_{M(AC)RMS}$), and energy ratings up to 8J.

See the Littelfuse Multilayer Suppressor Series also.

Agency Approvals

Recognized under the components program of Underwriters Laboratories.

Agency	Agency Approval	Agency File Number
	UL1449	E320116

Features

- RoHS compliant
- Leadless, surface mount chip in 5 x 8mm Size
- Voltage ratings $V_{M(AC)RMS}$ 14V to 275V
- Supplied in tape and reel or bulk pack
- No derating up to 125°C ambient
- High surge rated up to 600A

Absolute Maximum Ratings

• For ratings of individual members of a series, see Device Ratings and Specifications chart

Continuous	CH Series	Units
Steady State Applied Voltage:		
AC Voltage Range ($V_{M(AC)RMS}$)	14 to 275	V
DC Voltage Range ($V_{M(DC)}$)	18 to 369	V
Transient:		
Peak Pulse Current (I_{TM})		
For 8/20 μ s Current (See Figure 2)	100 to 600	A
Single Pulse Energy Range		
For 10/1000 μ s Current Wave (W_{TM})	1.0 to 8.0	J
Operating Ambient Temperature Range (T_A)	-55 to +125	°C
Storage Temperature Range (T_{STG})	-55 to +150	°C
Temperature Coefficient (αV) of Clamping Voltage (V_C) at Specified Test Current	<0.01	%/°C

CAUTION: Stresses above those listed in "Absolute Maximum Ratings" may cause permanent damage to the device. This is a stress only rating and operation of the device at these or any other conditions above those indicated in the operational sections of this specification is not implied.

Additional Information



Datasheet



Resources



Samples

Device Ratings and Specifications

Part Number	Maximum Ratings (125°C)				Specifications (25°C)					
	Continuous		Transient		Varistor Voltage at 1 mA DC Test Current			Max Clamping Volt V_C at Test Current (8/20 μ s)		Typical Capacitance
	V_{RMS}	V_{DC}	Energy (10/1000 μ s)	Peak Current (8/20 μ s)	MIN	V_{NIDC}	MAX	V_C	I_P	f=1MHz
	(V)	(V)	(J)	(A)	(V)	(V)	(V)	(V)	(A)	(pF)
V22CH8	14	18 (Note 3)	1.0 (Note2)	100	18.7	22.0	26.0	47	5	1600
V27CH8	17	22	1.0	100	23.0	27.0	31.1	57	5	1300
V33CH8	20	26	1.0	100*	29.5	33.0	36.5	68	5	750
V39CH8	25	31	1.0	100*	35.0	39.0	43.0	79	5	700
V47CH8	30	38	1.2	100*	42.0	47.0	52.0	92	5	650
V56CH8	35	45	1.4	100*	50.0	56.0	62.0	107	5	600
V68CH8	40	56	1.5	100*	61.0	68.0	75.0	127	10	500
V120CH8	75	102	2.0	250 ⁶	108.0	120.0	132.0	200	10	300
V150CH8	95	127	3.0	250 ⁶	135.0	150.0	165.0	250	10	250
V180CH8	115	153	4.0	250 ⁶	162.0	180.0	198.0	295	10	120
V200CH8	130	175	4.0	250 ⁶	184.0	200.0	228.0	340	10	110
V220CH8	140	180	5.0	250 ⁶	198.0	220.0	242.0	360	10	105
V240CH8	150	200	5.0	250 ⁶	212.0	240.0	268.0	395	10	100
V360CH8	230	300	6.0	250 ⁷	324.0	360.0	396.0	595	10	70
V390CH8	250	330	7.0	250 ⁷	354.0	390.0	429.0	650	10	60
V430CH8	275	369	8.0	250 ⁷	389.0	430.0	473.0	710	10	50

NOTES:

1. Power dissipation of transients not to exceed 0.25W.
2. Energy rating for impulse duration of 30ms minimum to one half of peak current value.
3. Also rated to withstand 24V for 5 minutes.
4. The Typical Capacitance is for reference only.
5. *High Surge Option (up to 400A) available for relevant voltage ratings.
6. High surge option(up to 600A) available for relevant voltage ratings.
7. High surge option(up to 500A) available for relevant voltage ratings.
8. Ultrasonic welding process is not recommended for CH series.

Current, Energy and Power Derating Curve

Continuous power dissipation capability is not an applicable design requirement for a suppressor, unless transients occur in rapid succession. Under this condition, the average power dissipation required is simply the energy (watt-seconds) per pulse times the number of pulses per second. The power so developed must be within the specifications shown on the Device Ratings and Specifications Table for the specific device. Furthermore, the operating values need to be derated at high temperatures as shown in this diagram. Because varistors can only dissipate a relatively small amount of average power they are, therefore, not suitable for repetitive applications that involve substantial amounts of average power dissipation.

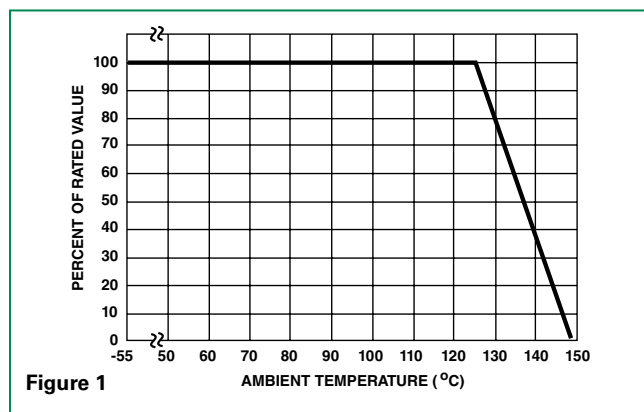

Peak Pulse Current Test Waveform

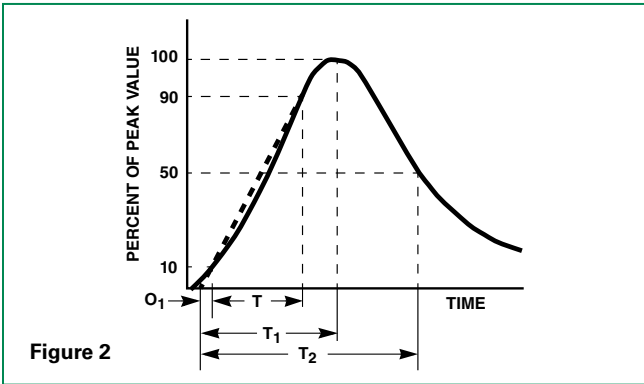

O_1 = Virtual Origin of Wave
 T = Time from 10% to 90% of Peak
 T_1 = Rise Time = $1.25 \times T$
 T_2 = Decay Time
Example:
 For an 8/20 μ s Current Waveform:
 8μ s = T_1 = Rise Time
 20μ s = T_2 = Decay Time

Clamping Voltage for V22CH8 – V68CH8

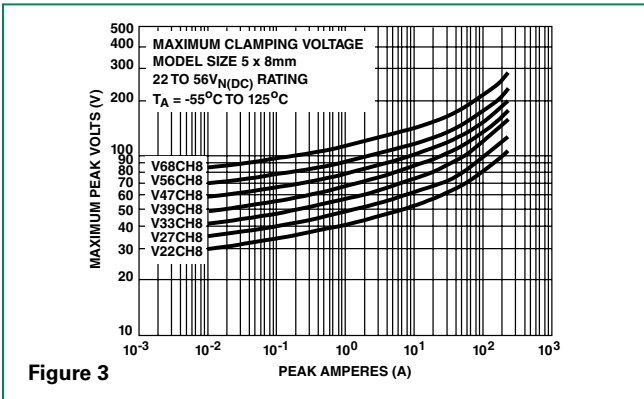

Clamping Voltage for V120CH8 – V430CH8

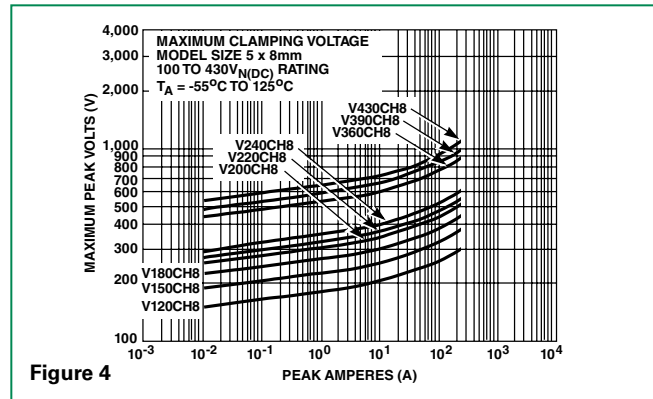

Pulse Rating Curves

Surge Current Rating Curves for V22CH8 - V56CH8

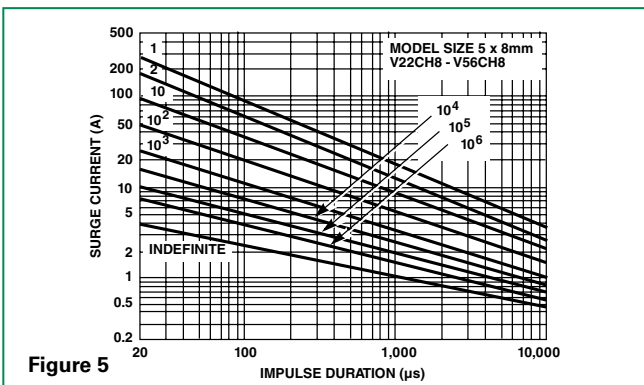

Surge Current Rating Curves for V120CH8 - V430CH8

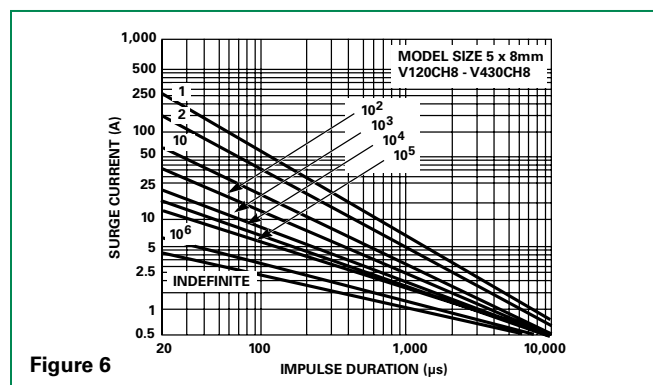

NOTE: If pulse ratings are exceeded, a shift of $V_{N(DC)}$ (at specified current) of more than +/-10% could result. This type of shift, which normally results in a decrease of $V_{N(DC)}$, may result in the device not meeting the original published specifications, but it does not prevent the device from continuing to function, and to provide ample protection.

Lead (Pb) Soldering Recommendations

The principal techniques used for the soldering of components in surface mount technology are IR Re-flow and Wave soldering. Typical profiles are shown on the right.

CH series devices have silver-platinum terminals (Ag/Pt), and the recommended solder is 62/36/2 (Sn/Pb/Ag), 60/40 (Sn/Pb) or 63/37 (Sn/Pb). Littelfuse also recommends an RMA solder flux.

Wave soldering is the most strenuous of the processes. To avoid the possibility of generating stresses due to thermal shock, a preheat stage in the soldering process is recommended, and the peak temperature of the solder process should be rigidly controlled.

When using a reflow process, care should be taken to ensure that the CH chip is not subjected to a thermal gradient steeper than 4 degrees per second; the ideal gradient being 2 degrees per second. During the soldering process, preheating to within 100 degrees of the solder's peak temperature is essential to minimize thermal shock.

Once the soldering process has been completed, it is still necessary to ensure that any further thermal shocks are avoided. One possible cause of thermal shock is hot printed circuit boards being removed from the solder process and subjected to cleaning solvents at room temperature. The boards must be allowed to cool gradually to less than 50°C before cleaning.

Reflow Solder Profile

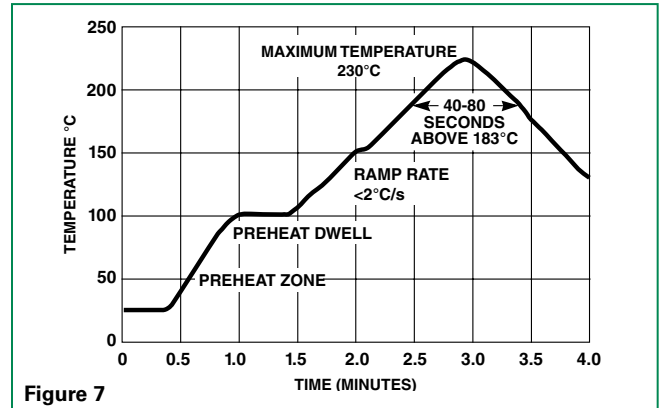

Figure 7

Wave Solder Profile

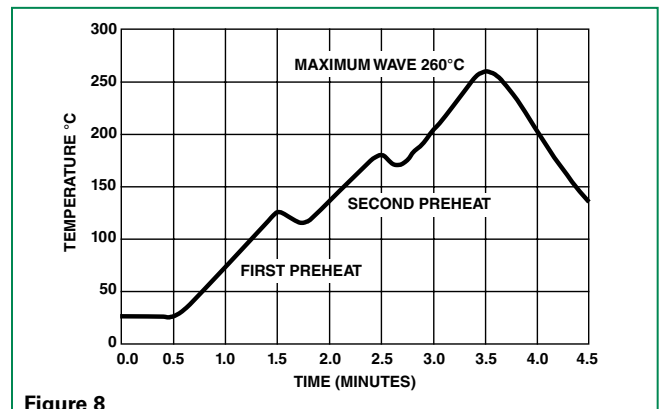

Figure 8

Lead-free (Pb-free) Soldering Recommendations

CH series devices have silver-platinum terminals (Ag/Pt), and the recommended Lead-free solder is 96.5/3.0/0.5 (SnAgCu) with an RMA flux, though there is a wide selection of pastes and fluxes available that should be compatible.

The reflow profile must be constrained by the maximums in the Lead-free Reflow Profile. For Lead-free Wave soldering, the Wave Solder Profile still applies.

Note: the Lead-free paste, flux and profile were used for evaluation purposes by Littelfuse, based upon industry standards and practices. There are multiple choices of all three available, it is advised that the customer explores the optimum combination for their process as processes vary considerably from site to site.

Lead-free Re-flow Solder Profile

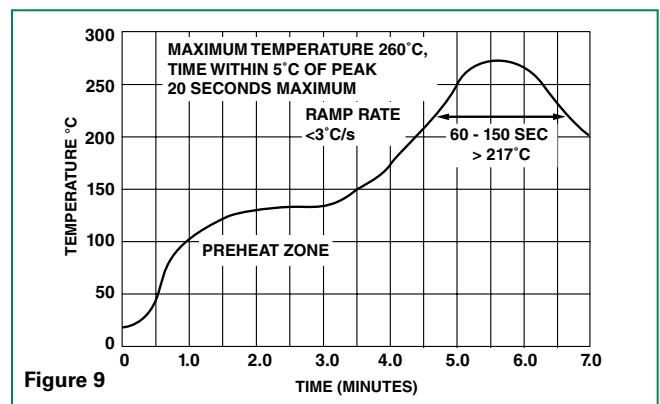
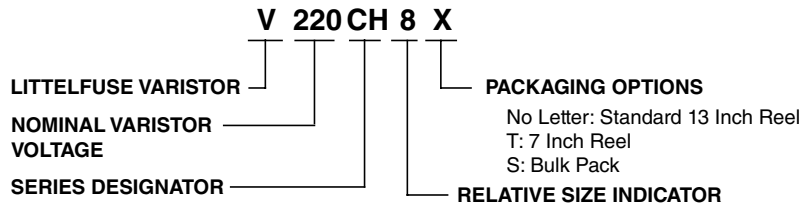

Figure 9

Part Numbering System



Dimensions

PAD LAYOUT DIMENSIONS

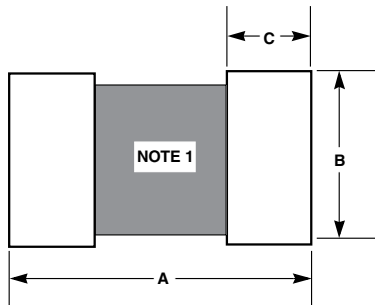

Symbol	Inches		Millimeters	
	Min	Max	Min	Max
A	0.402		10.210	
B	0.216		5.500	
C	0.087		2.210	
D	-	0.080	-	2.00
E	0.016	0.050	0.41	1.27
L	0.311	0.335	7.90	8.51
W	0.185	0.207	4.70	5.26

NOTE: Avoid metal runs in this area.

CHIP LAYOUT DIMENSIONS

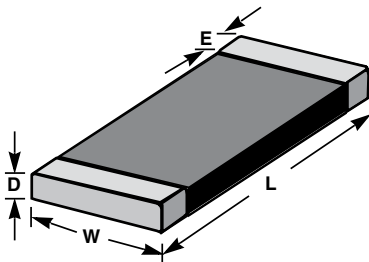

Tape and Reel Specifications

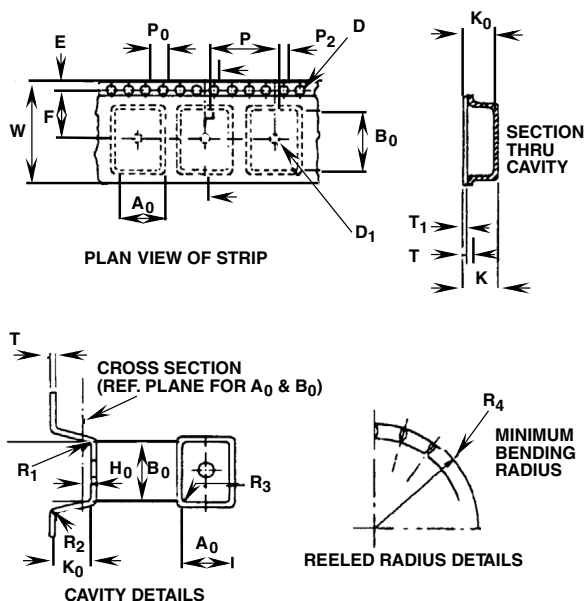

Symbol	Parameter	Size (mm)
B_0	Cavity Length	8.8 -/+ 0.1
A_0	Cavity Width	5.5 -/+ 0.1
K_0	Cavity Depth	2.0 Min.
H_0	Ref. Plane for A0 and B0	+ 0.10 0.3 - 0.05
R_1, R_2, R_3	Tape Cavity Radii	0.5 Max.
T	Carrier Tape Thickness	1.0 Max.
T_1	Cover Tape Thickness	0.1 Max.
E	Sprocket Hole from Edge	1.75 -/+ 0.1
P_0	Sprocket Hole Pitch	4.0 -/+ 0.1
D	Sprocket Hole Diameter	+ 0.1 1.5 - 0.0
P_2	Hole Centre to Component Centre	2.0 -/+ 0.15
R_4	Min. Bending Radius	30.5 Min.
D_1	Ejection Hole Diameter	1.5 Min.
K	Overall Thickness	3.0 Min.
P	Pitch Of Component	8.0 -/+ 0.1
F	Sprocket Hole to Ejection Hole	7.5 -/+ 0.1
W	Carrier Tape Width	16.0 -/+ 0.3

Notes :
 • Conforms to EIA-481-1, Revision A
 • Can be supplied to IEC Publication 286-3

Standard Packaging*

CH Series varistors are always shipped in tape and reel. The standard 13-inch reel utilized contains 4000 pieces.

Note also that the CH Series receives no branding on the chip itself.

*NOTE: It is recommended that parts be kept in the sealed bag provided and that parts be used as soon as possible when removed from bags.

Ordering Notes:

X3313: HIGH SURGE RATING OPTION --

Low voltage (V22~V68) standard parts high surge rating to 100A, to order high surge rated up to 400A with suffix X3313. Example:

Standard Model	Order As
V33CH8	V33CH8X3313

Special Packaging

- Option 1** 7-inch reels containing 1000 pieces are available. To order 7-inch reels add a 'T' suffix to the part number; e.g., V47CH8T.
- Option 2** For small quantities (less than 100 pieces) the units are shipped bulk pack. To order, add a 'S' suffix to the part number; e.g., V47CH8S.

Disclaimer Notice - Information furnished is believed to be accurate and reliable. However, users should independently evaluate the suitability of and test each product selected for their own applications. Littelfuse products are not designed for, and may not be used in, all applications. Read complete Disclaimer Notice at www.littelfuse.com/disclaimer-electronics.

SM7 Varistor Series

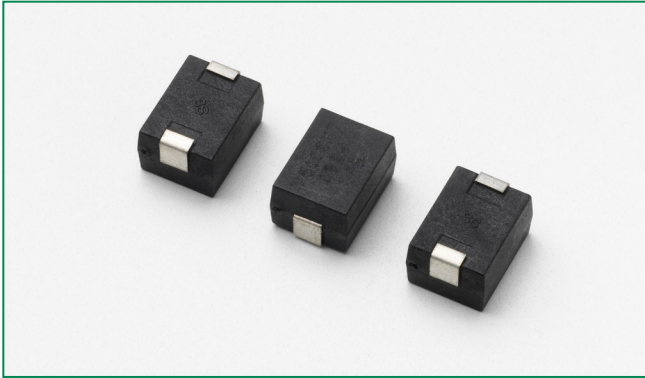

Description

The Littelfuse SM7 is a plastic-encapsulated surface mount MOV in a PPS material molded package with tin-plated terminal which is fully qualified in lead free soldering and available for both reflow and wave soldering process. SM7 is constructed with 7mm varistor element disc. Its maximum operating ambient temperature is 85°C with peak pulse current of 1200A.

Features

- Electrical equivalent to leaded types LA/ZA series
- AC Voltage Rating 50 to 510VAC rms
- No De-Rating up to 85°C ambient
- Good solderability
- Available in tape and reel
- Application of AC power meters
- Lead free and RoHS compliant

Agency Approvals

Agency	Agency Approval	Agency File Number
	UL1449	E320116

Absolute Maximum Ratings

• For ratings of individual members of a series, see Device Ratings and Specifications chart

Continuous	SM7 Series	Units
Steady State Applied Voltage:		
AC Voltage Range ($V_{M(AC)RMS}$)	50 to 510	V
DC Voltage Range ($V_{M(DC)}$)	68 to 675	V
Transients:		
Peak Pulse Current (I_{TM}) For 8/20 μ s Current Wave (See Figure 2)	1200	A
Single Pulse Energy Range For 10/1000 μ s Current Wave (W_{TM})	10 to 40	J
Operating Ambient Temperature Range (T_A)	-40 to +85	°C
Storage Temperature Range (T_{STG})	-55 to +125	°C
Temperature Coefficient (α) of Clamping Voltage (V_C) at Specified Test Current	<0.01	%/°C
Hi-Pot Encapsulation (COATING Isolation Voltage Capability) (Dielectric must withstand indicated DC voltage for one minute per MIL-STD 202, Method 301)	2500	V
COATING Insulation Resistance	1000	M Ω

CAUTION: Stresses above those listed in "Absolute Maximum Ratings" may cause permanent damage to the device. This is a stress only rating and operation of the device at these or any other conditions above those indicated in the operational sections of this specification is not implied.

Additional Information



Datasheet



Resources



Samples

SM7 Series Ratings & Specifications

Part Number	Maximum Rating (85°C)				Specifications (25°C)				
	Continuous		Transient		Varistor Voltage at 1mA DC Test Current		Maximum Clamping Voltage 8 x 20 μs		Typical Capacitance f = 1MHz
	V _{RMS}	V _{DC}	Energy 10 x 1000 μs	Peak Current 8 x 20 μs					
V _{M(AC)} (V)	V _{M(DC)} (V)	W _{TM} (J)	I _{TM} (A)	V _{NOM} Min (V)	V _{NOM} Max (V)	V _C (V)	I _{PK} (A)	C (pF)	
V50SM7	50	68	4	1200	73	91	135	10	700
V60SM7	60	81	5	1200	90	110	165	10	600
V115SM7	115	153	10	1200	162	198	300	10	200
V130SM7	130	175	11	1200	184	228	340	10	180
V140SM7	140	180	12	1200	198	242	360	10	160
V150SM7	150	200	13	1200	212	268	395	10	150
V175SM7	175	225	15	1200	247	303	455	10	130
V230SM7	230	300	20	1200	324	396	595	10	100
V250SM7	250	330	21	1200	354	429	650	10	90
V275SM7	275	369	23	1200	389	473	710	10	80
V300SM7	300	405	25	1200	420	517	775	10	70
V320SM7	320	420	25	1200	462	565	850	10	65
V385SM7	385	505	27	1200	558	682	1025	10	60
V420SM7	420	560	30	1200	610	748	1120	10	55
V460SM7	460	615	37	1200	640	790	1190	10	55
V480SM7	480	640	35	1200	670	825	1240	10	50
V510SM7	510	675	40	1200	735	910	1200	10	45

Product Dimensions

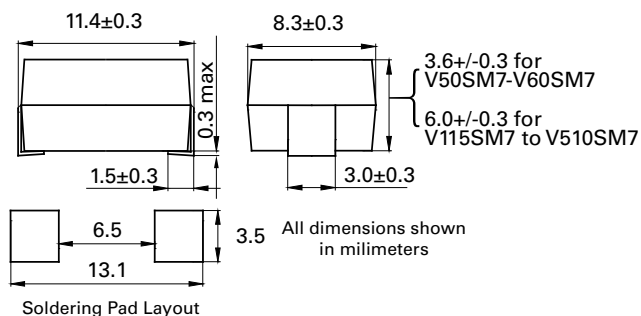

Part Numbering System

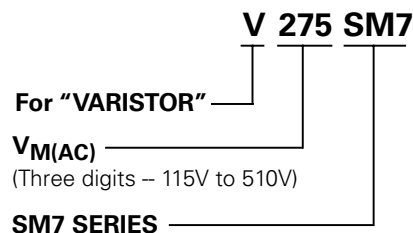

Lead (Pb) Soldering Recommendations

The principal techniques used for the soldering of components in surface mount technology are IR Re-flow and Wave soldering. Typical profiles are shown on the right.

The terminals of SM7 series devices are tin plated copper, and the recommended solder is 62/36/2 (Sn/Pb/Ag), 60/40 (Sn/Pb) or 63/37 (Sn/Pb). Littelfuse also recommends an RMA solder flux.

Wave soldering is the most strenuous of the processes. To avoid the possibility of generating stresses due to thermal shock, a preheat stage in the soldering process is recommended, and the peak temperature of the solder process should be rigidly controlled.

When using a reflow process, care should be taken to ensure that the SM7 chip is not subjected to a thermal gradient steeper than 4 degrees per second; the ideal gradient being 2 degrees per second. During the soldering process, preheating to within 100 degrees of the solder's peak temperature is essential to minimize thermal shock.

Once the soldering process has been completed, it is still necessary to ensure that any further thermal shocks are avoided. One possible cause of thermal shock is hot printed circuit boards being removed from the solder process and subjected to cleaning solvents at room temperature. The boards must be allowed to cool gradually to less than 50°C before cleaning.

Reflow Solder Profile

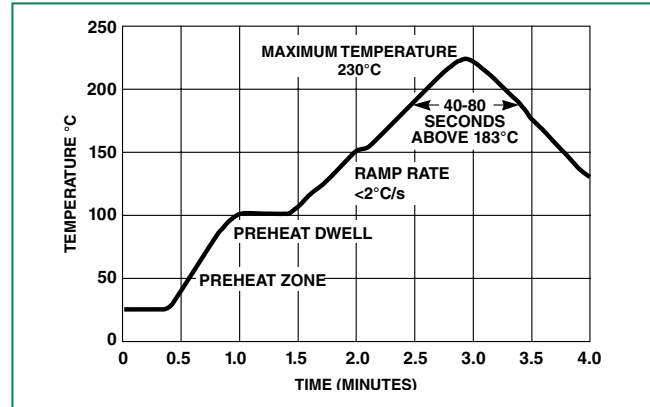

Wave Solder Profile

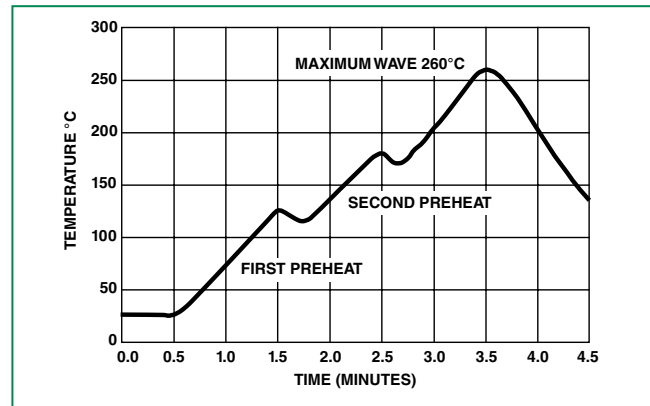

Lead-free (Pb-free) Soldering Recommendations

The terminals of SM7 series devices are tin plated copper, and the recommended Lead-free solder is 96.5/3.0/0.5 (SnAgCu) with an RMA flux, though there is a wide selection of pastes and fluxes available that should be compatible.

The reflow profile must be constrained by the maximums in the Lead-free Reflow Profile. For Lead-free Wave soldering, the Wave Solder Profile still applies.

Note: the Lead-free paste, flux and profile were used for evaluation purposes by Littelfuse, based upon industry standards and practices. There are multiple choices of all three available, it is advised that the customer explores the optimum combination for their process as processes vary considerably from site to site.

Lead-free Re-flow Solder Profile

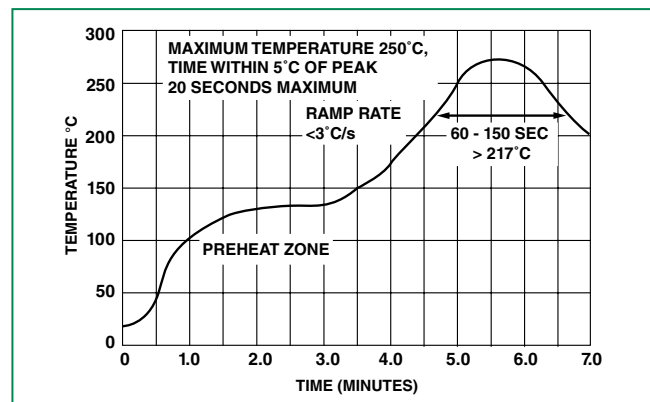

Peak Current, Energy and Power Derating Curve

For applications exceeding 85°C ambient temperature, the peak surge current and energy ratings must be reduced as shown below

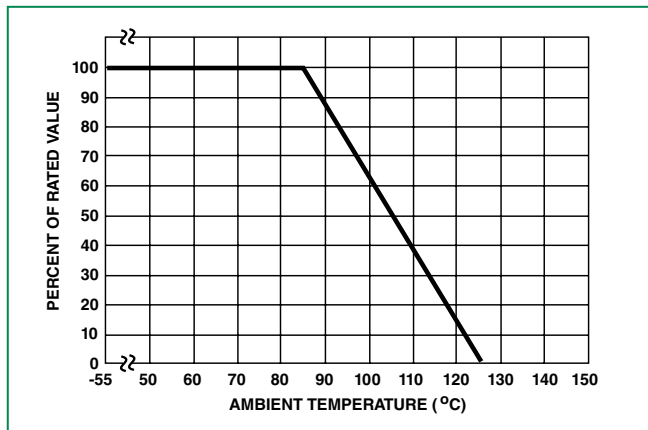

Peak Pulse Current Test Waveform for Clamping Voltage

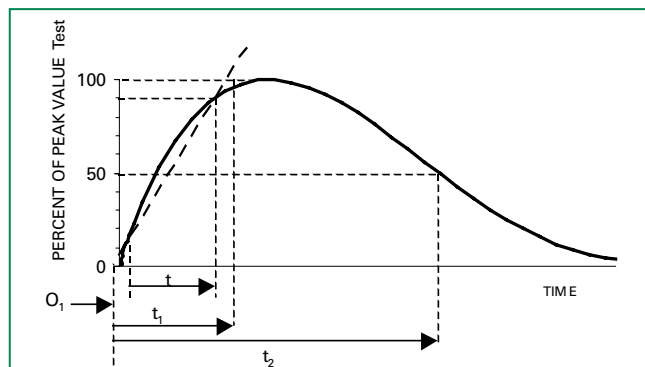

O_1 = Virtual Origin of Wave
 T_1 = Time from 10% to 90% of Peak
 T_{r1} = Rise Time = 1.25 x T
 T_{d2} = Decay Time

Example - For an 8/20 μ s Current Waveform:

8μ s = T_{r1} = Rise Time
 20μ s = T_{d2} = Decay Time

V-I Limit Curves

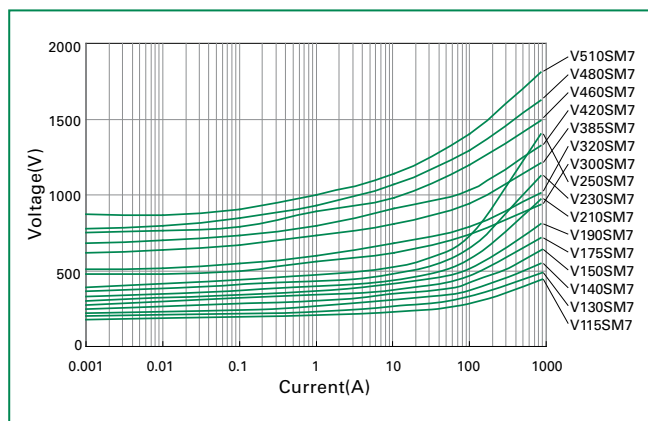

NOTE: If pulse ratings are exceeded, a shift of $V_{N(DC)}$ (at specified current) of more than $\pm 10\%$ could result. This type of shift, which normally results in a decrease of $V_{N(DC)}$, may result in the device not meeting the original published specifications, but it does not prevent the device from continuing to function, and to provide ample protection.

Pulse Rating Curves

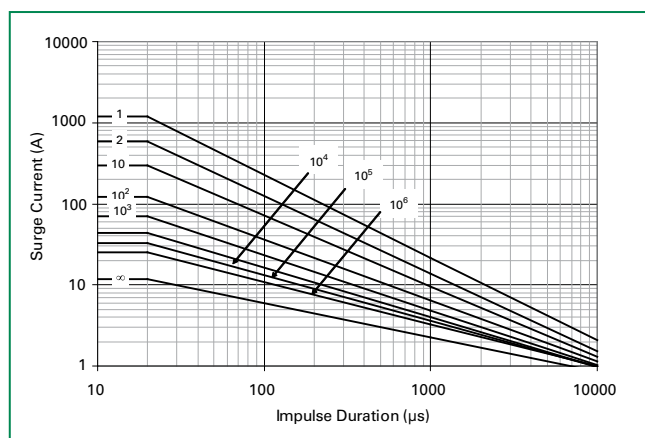

Physical Specifications

Lead Material	Folded Tin Plated Metal Leads
Soldering Characteristics	J-STD-002
Coating	Molded Plastic Meets UL94 V-0 Requirement

Environmental Specifications

Operating Ambient Temperature Range (T_A)	-40°C to +85°C
Storage Temperature Range (T_{STG})	-55°C to 125°C
Solvent Resistance	MIL STD 202, Method 215
Moisture Sensitivity	Level 1, J-STD-020 (V115SM7 to V510SM7)

Disclaimer Notice - Information furnished is believed to be accurate and reliable. However, users should independently evaluate the suitability of and test each product selected for their own applications. Littelfuse products are not designed for, and may not be used in, all applications. Read complete Disclaimer Notice at www.littelfuse.com/disclaimer-electronics.

Tape & Reel Specifications for V50SM7 and V60SM7

Carrier Tape

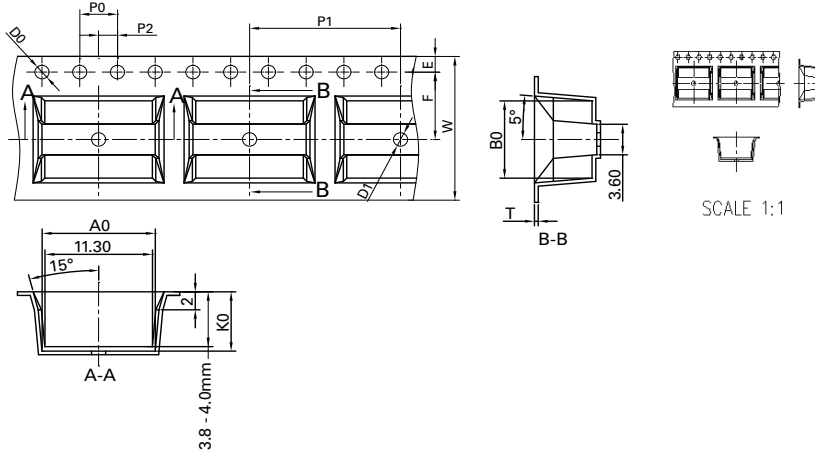

	mm
W	16.00±0.30
T	0.40±0.05
A0	11.80±0.10
B0	8.60±0.10
K0	4.80±0.10
E	1.75±0.10
F	7.50±0.10
P0	4.00±0.10
P1	16.00±0.10
P2	2.00±0.10
D0	ø1.50 +0.10/-0
D1	ø1.50 +0.10/-0

Plastic Reel

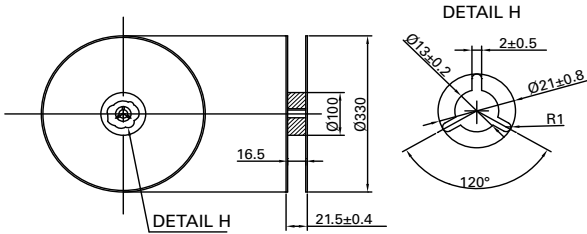

- NOTES:
 1) All dimensions per EIA-481-c
 2) 10 pitches cumulative tolerance on tape ±0.20mm
 3) Quantity per 13 inch (330 mm) reel: 600 pcs

Tape & Reel Specifications for V115SM7 to V510SM7

Carrier Tape

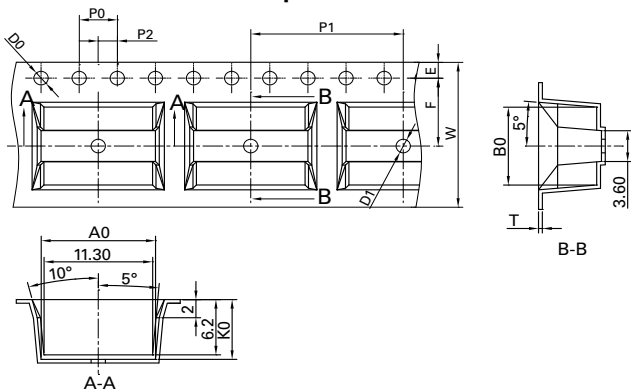

	mm
W	16.00±0.30
T	0.40±0.05
A0	11.80±0.10
B0	8.60±0.10
K0	6.80±0.10
E	1.75±0.10
F	7.50±0.10
P0	4.00±0.10
P1	16.00±0.10
P2	2.00±0.10
D0	ø1.50 +0.10/-0
D1	ø1.50 +0.10/-0

Plastic Reel

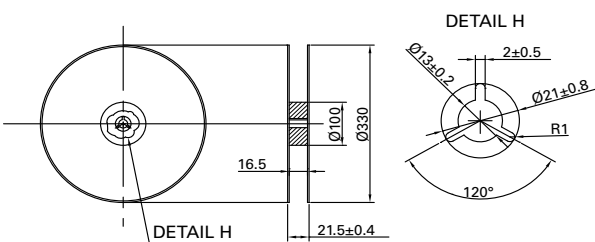

- NOTES:
 1) All dimensions per EIA-481-c
 2) 10 pitches cumulative tolerance on tape ±0.20mm
 3) Quantity per 13 inch (330 mm) reel: 600 pcs

SM20 Varistor Series



Agency Approvals

Agency	Agency Approval	Agency File Number
	UL1449	E320116

Additional Information



Datasheet



Resources



Samples

Description

The Littelfuse 20mm SMD Series is a surface-mount metal oxide varistor device, for use in applications requiring hi-energy / transient current capability.

The AC rated parts are designed to operate continuously across AC power lines. The DC rated parts are suitable for Automotive applications. The series comprises a Nylon molded package with folded tin plated metal leads for soldering to board.

The SMD Series is based on radial 20mm internal varistor element with similar characteristics to the Littelfuse LA / ZA series of varistors.

Features

- DC Voltage Rating 26 - 420VDC
- AC Voltage Rating 20Vac - 320AC
- No De-Rating up to 85°C ambient
- Lead-Free, Halogen-Free and RoHS Compliant
- Low voltage devices specified for automotive load dump energy
- Available in "waffle" tray packaging

Absolute Maximum Ratings

• For ratings of individual members of a series, see Device Ratings and Specifications chart

Continuous	SM20 Series	Units
Steady State Applied Voltage:		
AC Voltage Range ($V_{MIACIRMS}$)	20 to 320	V
DC Voltage Range (V_{MIDC})	26 to 420	V
Transients:		
Peak Pulse Current (I_{TM}) 8/20 μ s Current Wave, Single Pulse	up to 6500	A
Single Pulse Energy Capability (W_{TM}) 10/1000 μ s Current Wave	165	J
Load Dump Energy Capability ($t_d \geq 30$ ms)	160	J
Operating Ambient Temperature Range (T_A)	-40 to +85	°C
Storage Temperature Range (T_{STG})	-55 to +125	°C
Temperature Coefficient (α) of Clamping Voltage (V_c) at Specified Test Current	<0.01	%/°C
Hi-Pot Encapsulation (COATING Isolation Voltage Capability) (Dielectric must withstand indicated DC voltage for one minute per MIL-STD 202, Method 301)	2500	V
COATING Insulation Resistance	1000	M Ω

CAUTION: Stresses above those listed in "Absolute Maximum Ratings" may cause permanent damage to the device. This is a stress only rating and operation of the device at these or any other conditions above those indicated in the operational sections of this specification is not implied.

SM20 Series Ratings & Specifications

Part Number	Branding	Maximum Rating (85°C)				Specifications (25°C)				
		Continuous		Transient		Varistor Voltage at 1mA DC Test Current		Maximum Clamping Voltage 8 x 20 μs		Typical Capacitance f = 1MHz
		V _{RMS}	V _{DC}	Energy 10 x 1000 μs	Peak Current 8 x 20 μs	V _{NOM} Min	V _{NOM} Max	V _C	I _{PK}	C
		V _{M(AC)}	V _{M(DC)}	W _{TM} 1x pulse	I _{TM} 1x pulse	(V)	(V)	(V)	(A)	(pF)
V26SM20	26SM20	20	26	20 160 (note 1)	2000	32 (10mA)	40 (10mA)	63	20	12000
V175SM20	175SM20	175	225	90	6500	247	303	455	100	1400
V230SM20	230SM20	230	300	122	6500	324	396	595	100	1100
V250SM20	250SM20	250	330	130	6500	354	429	650	100	1000
V275SM20	275SM20	275	369	140	6500	389	473	710	100	900
V300SM20	300SM20	300	405	165	6500	420	517	775	100	800
V320SM20	320SM20	320	420	150	6500	462	540	810	100	750

1. Energy rating for impulse duration of 30ms minimum to one half of peak current (automotive load dump).

Peak Current, Energy and Power Derating Curve

For applications exceeding 85°C ambient temperature, the peak surge current and energy ratings must be reduced as shown below

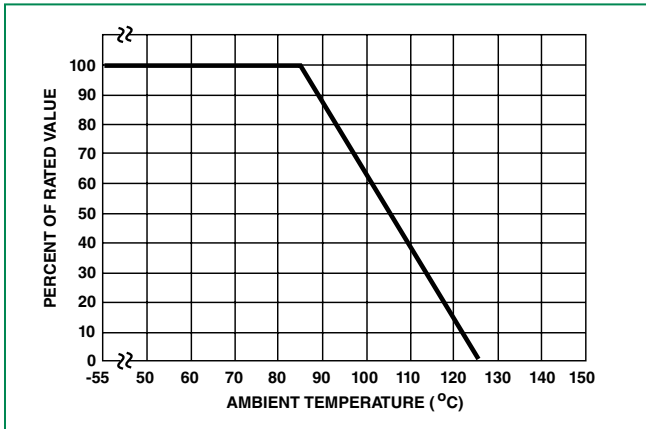

Repetitive Surge Capability

V175SM20 - V320SM20

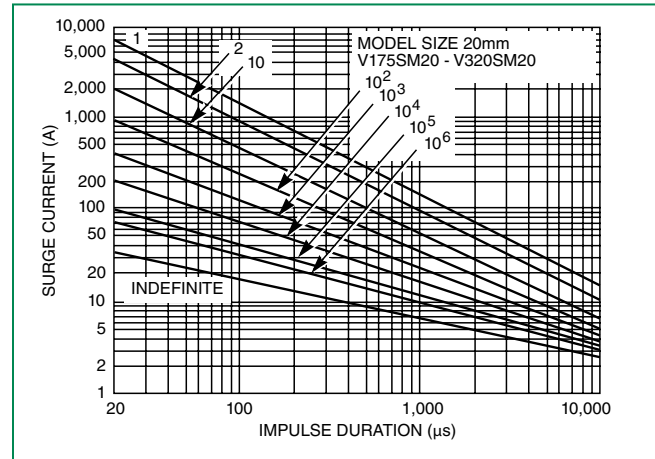

Peak Pulse Current Test Waveform for Clamping Voltage

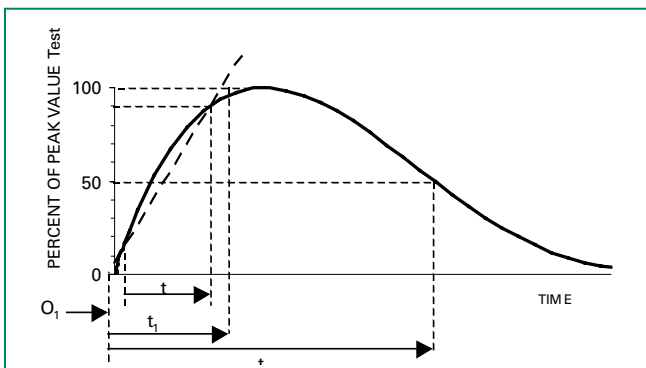

O₁ = Virtual Origin of Wave
T = Time from 10% to 90% of Peak
T₁ = Rise Time = 1.25 x T
T₂ = Decay Time

Example - For an 8/20 μs Current Waveform:

8 μs = T₁ = Rise Time
20 μs = T₂ = Decay Time

Lead (Pb) Soldering Recommendations

The principal techniques used for the soldering of components in surface mount technology are IR Re-flow and Wave soldering. Typical profiles are shown on the right.

The terminals of SM20 series devices are tin plated copper, and the recommended solder is 62/36/2 (Sn/Pb/Ag), 60/40 (Sn/Pb) or 63/37 (Sn/Pb). Littelfuse also recommends an RMA solder flux.

Wave soldering is the most strenuous of the processes. To avoid the possibility of generating stresses due to thermal shock, a preheat stage in the soldering process is recommended, and the peak temperature of the solder process should be rigidly controlled.

When using a reflow process, care should be taken to ensure that the SM20 chip is not subjected to a thermal gradient steeper than 4 degrees per second; the ideal gradient being 2 degrees per second. During the soldering process, preheating to within 100 degrees of the solder's peak temperature is essential to minimize thermal shock.

Once the soldering process has been completed, it is still necessary to ensure that any further thermal shocks are avoided. One possible cause of thermal shock is hot printed circuit boards being removed from the solder process and subjected to cleaning solvents at room temperature. The boards must be allowed to cool gradually to less than 50°C before cleaning.

Reflow Solder Profile

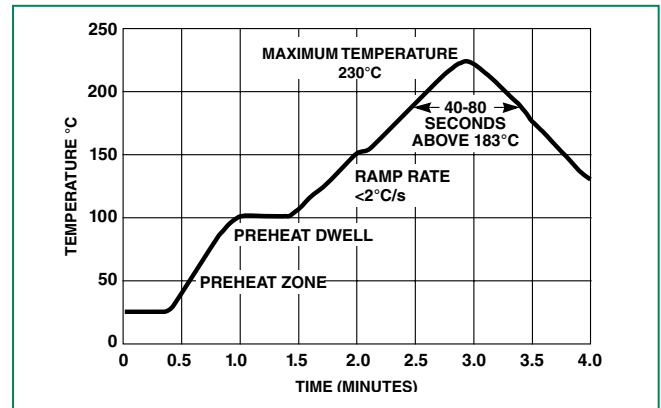

Wave Solder Profile

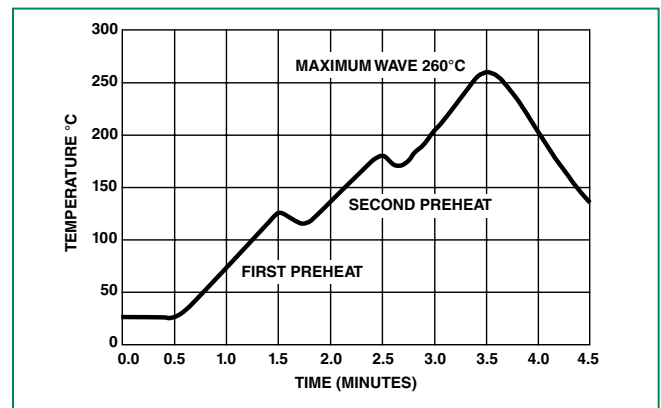

Lead-free (Pb-free) Soldering Recommendations

The terminals of SM20 series devices are tin plated copper, and the recommended Lead-free solder is 96.5/3.0/0.5 (SnAgCu) with an RMA flux, though there is a wide selection of pastes and fluxes available that should be compatible.

The reflow profile must be constrained by the maximums in the Lead-free Reflow Profile. For Lead-free Wave soldering, the Wave Solder Profile still applies.

Note: the Lead-free paste, flux and profile were used for evaluation purposes by Littelfuse, based upon industry standards and practices. There are multiple choices of all three available, it is advised that the customer explores the optimum combination for their process as processes vary considerably from site to site.

Lead-free Re-flow Solder Profile

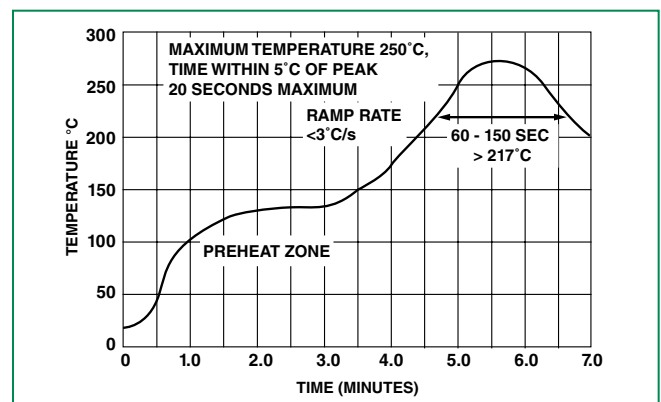

Physical Specifications

Lead Material	Folded Tin Plated Metal Leads
Soldering Characteristics	J-STD-002
Coating	Molded Plastic Meets UL94 V-0 Requirement

Environmental Specifications

Operating Ambient Temperature Range (T_A)	-40°C to +85°C
Storage Temperature Range (T_{STG})	-55°C to 125°C
Solvent Resistance	MIL STD 202, Method 215
Moisture Sensitivity	Level 1, J-STD-020

Product Dimensions

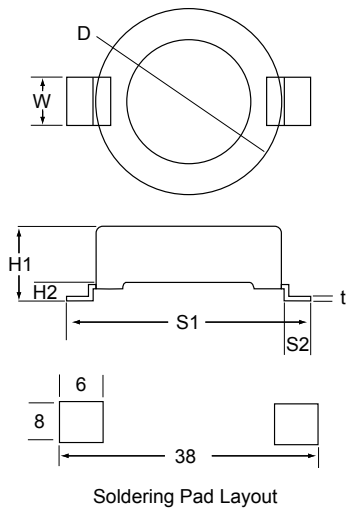

Symbol	Millimeters	
	Min	Max
D (diameter)	—	26
H1	—	10.5
H2	1.0	—
t	0.50	0.70
S1	32.5	35
S2	3.0	4.5
W	6.2	6.6

Packaging

Standard Packaging is in "Waffle" trays:

Quantity per tray: 36 pieces

Quantity per box: 108 pieces

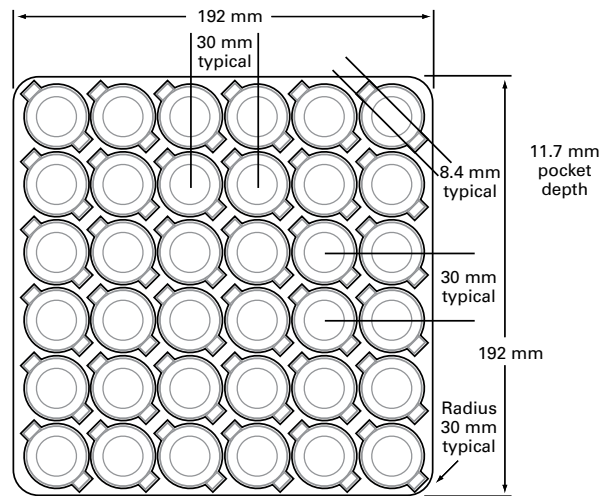

Part Numbering System

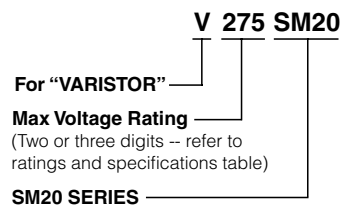

Disclaimer Notice - Information furnished is believed to be accurate and reliable. However, users should independently evaluate the suitability of and test each product selected for their own applications. Littelfuse products are not designed for, and may not be used in, all applications. Read complete Disclaimer Notice at www.littelfuse.com/disclaimer-electronics.

LV UltraMOV® Varistor Series

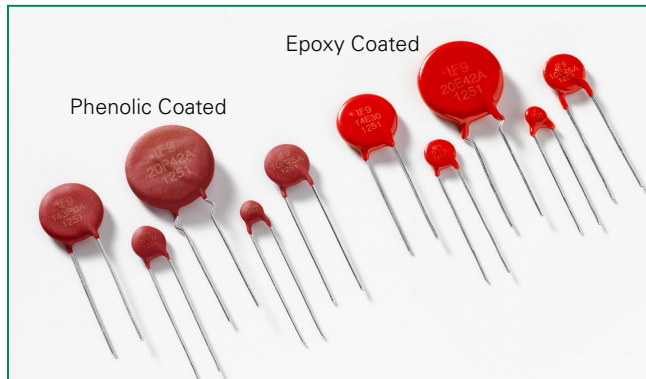

Agency Approvals

Agency	Agency Approval	Agency File Number
	UL 1449	E320116 ¹
	IEC/EN 61051-1 IEC 61051-2 IEC 61051-2-2 IEC 60950-1 (Annex Q) 10mm, 14mm and 20mm with phenolic coating only	J 50324242 ²

Notes:
1. All epoxy coated sizes are UL Recognized while only 10mm, 14mm, and 20mm phenolic coated parts are UL recognized.
2. Phenolic coated only.

Additional Information



Datasheet



Resources



Samples

Absolute Maximum Ratings

• For ratings of individual members of a series, see Device Ratings and Specifications chart

	Low Voltage Series	Units
Continuous:		
Steady State Applied Voltage:		
AC Voltage Range ($V_{M(AC)RMS}$)	11 to 95	V
DC Voltage Range ($V_{M(DC)}$)	14 to 125	V
Transient:		
Non-Repetitive Surge Current, 8/20µs Waveform (I_{TM})	500 to 10,000	A
Non-Repetitive Energy Capability, 2ms Waveform (W_{TM})	0.8 to 150	J
Operating Ambient Temperature Range (T_A) for Epoxy coated	-40 to +85	°C
Operating Ambient Temperature Range (T_A) for Phenolic coated	-40 to +125	°C
Storage Temperature Range (T_{STG}) for Epoxy coated	-40 to +125	°C
Storage Temperature Range (T_{STG}) for Phenolic coated	-40 to +150	°C
Temperature Coefficient (αV) of Clamping Voltage (V_C) at Specified Test Current	< 0.01%	°C
Hi-Pot Encapsulation (Isolation Voltage Capability) for Epoxy coated	2500	V
Hi-Pot Encapsulation (Isolation Voltage Capability) for Phenolic coated	800	V
Epoxy Coating Insulation Resistance	>1,000	MΩ

CAUTION: Stresses above those listed in "Absolute Maximum Ratings" may cause permanent damage to the device. This is a stress only rating and operation of the device at these or any other conditions above those indicated in the operational sections of this specification is not implied.

Description

The Littelfuse LV UltraMOV® Varistor Series provides an ideal circuit protection solution for DC voltage applications.

The maximum peak surge current rating can reach up to 10kA (8/20µs pulse) to protect against the damage from high peak surge current induced by indirect lightning strike interference, system switching transients, and abnormal fast transients from the power source.

Available in five model sizes: 5mm, 7mm, 10mm, 14mm, and 20mm, these device feature a wide voltage range from 14V to 125V.

Features

- Breakthrough in low voltage varistor design provides high peak (up to 10KA) surge current rating
- Reduced footprint and volume required for surge protection
- Wide operating voltage range $V_{M(AC)RMS}$ 11V to 95V and $V_{M(DC)}$ 14V to 125V
- Lead-free, Halogen-Free and RoHS compliant
- High operating temperature range up to 125°C (phenolic coating option)
- 5 model sizes available: 5, 7, 10, 14, and 20mm
- 10mm, 14mm and 20mm devices are UL Recognized and TUV certified with 800V isolation voltage rating.

Applications

- LED lights
- Cordless phones
- Audio and video devices
- Mobile phone chargers
- Security systems
- Fire alarm systems
- Automation control systems
- Industrial control contact relays
- Surge protection device
- Telecom power systems
- Wireless base stations

LV UltraMOV® Series Device Ratings and Specifications

Epoxy Coated Models		Phenolic Coated Models ²		Size Disc Dia. (mm)	Max Continuous Voltage		Varistor Voltage at 1mA			Maximum Clamping Voltage		Max Peak Current (8 x 20µs 1 pulse)	Energy Rating (2ms, 1 pulse)	Typical Capacitance f = 1MHz
Part Number (Base part)	Branding	Part Number (Base part)	Branding		V _{MIAC(RMS)}	V _{M(DC)}	V _{NOM Min}	V _{NOM Nom}	V _{NOM Max}	V _C	I _{PK}			
					(V)	(V)	(V)	(V)	(V)	(V)	(A)	(A)	(J)	(pF)
V05E11P	P5E11	V05P11P	P5P11	5	11	14	16.2	18.0	19.8	36	1	500	0.8	1300
V07E11P	P7E11	V07P11P	P7P11	7	11	14	16.2	18.0	19.8	36	2.5	1000	2.0	2900
V10E11P	P10E11	V10P11P	P10P11	10	11	14	16.2	18.0	19.8	36	5	2000	4.2	5450
V14E11P	P14E11	V14P11P	P14P11	14	11	14	16.2	18.0	19.8	36	10	4000	8	12000
V20E11P	P20E11	V20P11P	P20P11	20	11	14	16.2	18.0	19.8	36	20	8000	25	26000
V05E14P	P5E14	V05P14P	P5P14	5	14	18	19.8	22.0	24.2	43	1	500	1	1100
V07E14P	P7E14	V07P14P	P7P14	7	14	18	19.8	22.0	24.2	43	2.5	1000	2.2	2450
V10E14P	P10E14	V10P14P	P10P14	10	14	18	19.8	22.0	24.2	43	5	2000	5	4650
V14E14P	P14E14	V14P14P	P14P14	14	14	18	19.8	22.0	24.2	43	10	4000	10	10200
V20E14P	P20E14	V20P14P	P20P14	20	14	18	19.8	22.0	24.2	43	20	8000	28	22200
V05E17P	P5E17	V05P17P	P5P17	5	17	22	24.3	27.0	29.7	53	1	500	1.4	950
V07E17P	P7E17	V07P17P	P7P17	7	17	22	24.3	27.0	29.7	53	2.5	1000	2.8	2100
V10E17P	P10E17	V10P17P	P10P17	10	17	22	24.3	27.0	29.7	53	5	2000	6.5	3900
V14E17P	P14E17	V14P17P	P14P17	14	17	22	24.3	27.0	29.7	53	10	4000	13	8700
V20E17P	P20E17	V20P17P	P20P17	20	17	22	24.3	27.0	29.7	53	20	8000	35	18750
V05E20P	P5E20	V05P20P	P5P20	5	20	26	29.7	33.0	36.3	65	1	500	2	850
V07E20P	P7E20	V07P20P	P7P20	7	20	26	29.7	33.0	36.3	65	2.5	1000	4.2	1750
V10E20P	P10E20	V10P20P	P10P20	10	20	26	29.7	33.0	36.3	65	5	2000	10	3400
V14E20P	P14E20	V14P20P	P14P20	14	20	26	29.7	33.0	36.3	65	10	4000	20	7500
V20E20P	P20E20	V20P20P	P20P20	20	20	26	29.7	33.0	36.3	65	20	8000	58	15000
V05E23P	P5E23	V05P23P	P5P23	5	23	28	32.4	36.0	39.6	71	1	500	2.2	800
V07E23P	P7E23	V07P23P	P7P23	7	23	28	32.4	36.0	39.6	71	2.5	1000	5.0	1650
V10E23P	P10E23	V10P23P	P10P23	10	23	28	32.4	36.0	39.6	71	5	2000	12	3200
V14E23P	P14E23	V14P23P	P14P23	14	23	28	32.4	36.0	39.6	71	10	4000	23	7000
V20E23P	P20E23	V20P23P	P20P23	20	23	28	32.4	36.0	39.6	71	20	8000	70	14000
V05E25P	P5E25	V05P25P	P5P25	5	25	31	35.1	39.0	42.9	77	1	500	2.5	750
V07E25P	P7E25	V07P25P	P7P25	7	25	31	35.1	39.0	42.9	77	2.5	1000	5.5	1500
V10E25P	P10E25	V10P25P	P10P25	10	25	31	35.1	39.0	42.9	77	5	2000	13	2900
V14E25P	P14E25	V14P25P	P14P25	14	25	31	35.1	39.0	42.9	77	10	4000	25	6200
V20E25P	P20E25	V20P25P	P20P25	20	25	31	35.1	39.0	42.9	77	20	8000	77	13500
V05E30P	P5E30	V05P30P	P5P30	5	30	38	42.3	47.0	51.7	93	1	500	3.1	650
V07E30P	P7E30	V07P30P	P7P30	7	30	38	42.3	47.0	51.7	93	2.5	1000	7	1350
V10E30P	P10E30	V10P30P	P10P30	10	30	38	42.3	47.0	51.7	93	5	2000	15.5	2550
V14E30P	P14E30	V14P30P	P14P30	14	30	38	42.3	47.0	51.7	93	10	4000	32	5550
V20E30P	P20E30	V20P30P	P20P30	20	30	38	42.3	47.0	51.7	93	20	8000	90	12000
V05E35P	P5E35	V05P35P	P5P35	5	35	45	50.4	56.0	61.6	93	1	500	4	550
V07E35P	P7E35	V07P35P	P7P35	7	35	45	50.4	56.0	61.6	110	2.5	1000	9	1200
V10E35P	P10E35	V10P35P	P10P35	10	35	45	50.4	56.0	61.6	110	5	2000	20	2200
V14E35P	P14E35	V14P35P	P14P35	14	35	45	50.4	56.0	61.6	110	10	4000	40	5000
V20E35P	P20E35	V20P35P	P20P35	20	35	45	50.4	56.0	61.6	110	20	8000	115	10500
V05E40P	P5E40	V05P40P	P5P40	5	40	56	61.2	68.0	74.8	135	1	500	5	500
V07E40P	P7E40	V07P40P	P7P40	7	40	56	61.2	68.0	74.8	135	2.5	1000	11	1000
V10E40P	P10E40	V10P40P	P10P40	10	40	56	61.2	68.0	74.8	135	5	2000	25	1850
V14E40P	P14E40	V14P40P	P14P40	14	40	56	61.2	68.0	74.8	135	10	4000	50	4000
V20E40P	P20E40	V20P40P	P20P40	20	40	56	61.2	68.0	74.8	135	20	8000	140	8500

Notes:
 1. Average power dissipation of transients not to exceed 0.2W, 0.25W, 0.4W, 0.6W or 1W for model sizes 5mm, 7mm, 10mm, 14mm, and 20mm, respectively.
 2. 10mm, 14mm and 20mm devices are UL recognized with 800V isolation voltage rating.

Epoxy Coated Models		Phenolic Coated Models ²		Size Disc Dia. (mm)	Max Continuous Voltage		Varistor Voltage at 1mA			Maximum Clamping Voltage		Max Peak Current (8 x 20µs 1 pulse)	Energy Rating (2ms, 1 pulse)	Typical Capacitance f = 1MHz
Part Number (Base part)	Branding	Part Number (Base part)	Branding		V _{M(ACRMS)}	V _{M(DC)}	V _{NOM Min}	V _{NOM Nom}	V _{NOM Max}	V _C	I _{PK}			
					(V)	(V)	(V)	(V)	(V)	(V)	(A)	I _{TM}	W _{TM}	C
V05E50P	P5E50	V05P50P	P5P50	5	50	65	73.8	82	90.2	135	5	800	5	350
V07E50P	P7E50	V07P50P	P7P50	7	50	65	73.8	82	90.2	135	10	1750	10	800
V10E50P	P10E50	V10P50P	P10P50	10	50	65	73.8	82	90.2	135	25	3500	20	1400
V14E50P	P14E50	V14P50P	P14P50	14	50	65	73.8	82	90.2	145	50	6500	40	3000
V20E50P	P20E50	V20P50P	P20P50	20	50	65	73.8	82	90.2	145	100	10000	80	6000
V05E60P	P5E60	V05P60P	P5P60	5	60	85	90	100	110	165	5	800	6	310
V07E60P	P7E60	V07P60P	P7P60	7	60	85	90	100	110	165	10	1750	12	700
V10E60P	P10E60	V10P60P	P10P60	10	60	85	90	100	110	165	25	3500	24	1200
V14E60P	P14E60	V14P60P	P14P60	14	60	85	90	100	110	175	50	6500	50	2500
V20E60P	P20E60	V20P60P	P20P60	20	60	85	90	100	110	175	100	10000	100	5200
V05E75P	P5E75	V05P75P	P5P75	5	75	100	108	120	132	205	5	800	7	260
V07E75P	P7E75	V07P75P	P7P75	7	75	100	108	120	132	205	10	1750	14	600
V10E75P	P10E75	V10P75P	P10P75	10	75	100	108	120	132	200	25	3500	29	1100
V14E75P	P14E75	V14P75P	P14P75	14	75	100	108	120	132	210	50	6500	60	2300
V20E75P	P20E75	V20P75P	P20P75	20	75	100	108	120	132	210	100	10000	120	4800
V05E95P	P5E95	V05P95P	P5P95	5	95	125	135	150	165	250	5	800	9	200
V07E95P	P7E95	V07P95P	P7P95	7	95	125	135	150	165	250	10	1750	18	520
V10E95P	P10E95	V10P95P	P10P95	10	95	125	135	150	165	250	25	3500	36	800
V14E95P	P14E95	V14P95P	P14P95	14	95	125	135	150	165	250	50	6500	75	1700
V20E95P	P20E95	V20P95P	P20P95	20	95	125	135	150	165	250	100	10000	150	3700

Notes:

1. Average power dissipation of transients not to exceed 0.2W, 0.25W, 0.4W, 0.6W or 1W for model sizes 5mm, 7mm, 10mm, 14mm, and 20mm respectively.
2. 10mm, 14mm and 20mm devices are UL recognized and TUV certified with 800V isolation voltage rating.

Current Energy and Power Dissipation Ratings

Figure 1A - Power Derating for Epoxy Coated

For applications exceeding 85°C ambient temperature, the peak surge current and energy ratings must be reduced as shown below.

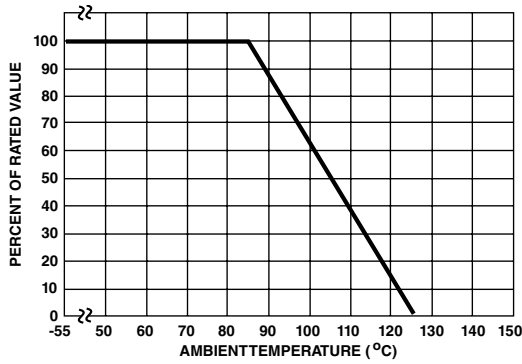
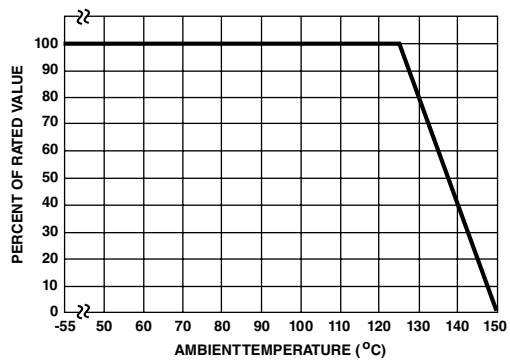
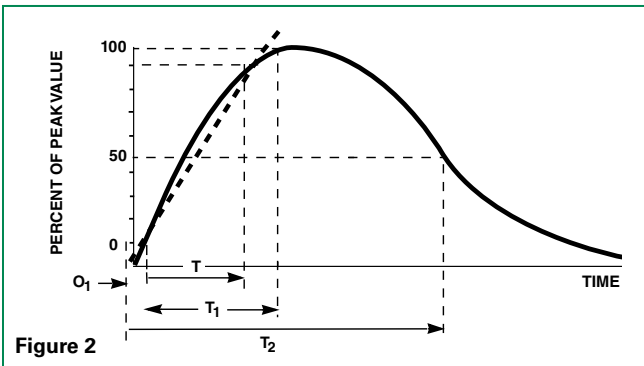

Figure 1B - Power Derating for Phenolic Coated

For applications exceeding 125°C ambient temperature, the peak surge current and energy ratings must be reduced as shown below.



Peak Pulse Current Test Waveform for Clamping Voltage



- O_1 = Virtual Origin of Wave
- T = Time from 10% to 90% of Peak
- T_1 = Rise Time = $1.25 \times T$
- T_2 = Decay Time

Example - For an 8/20µs Current Waveform:

- $8\mu s = T_1$ = Rise Time
- $20\mu s = T_2$ = Decay Time

Maximum Clamping Voltage for 5mm Parts

V05x11P - V05x40P

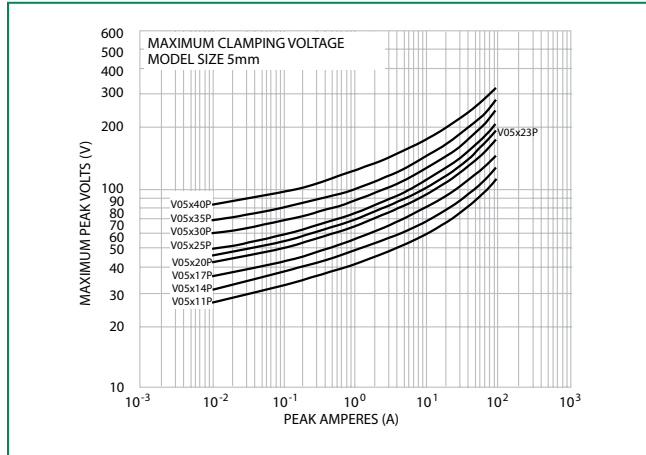

Maximum Clamping Voltage for 7mm Parts

V07x11P - V07x40P

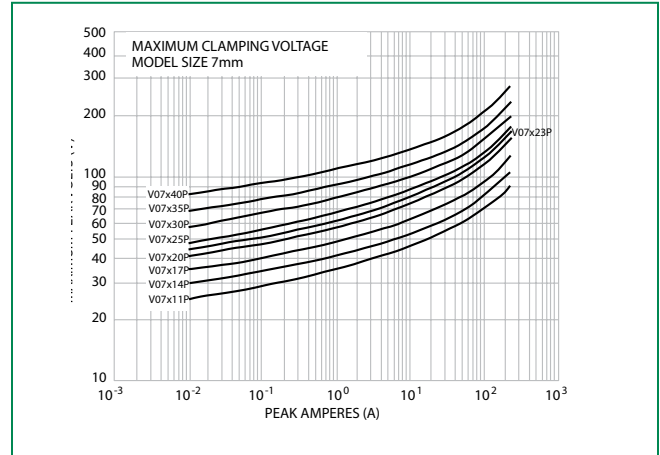

Maximum Clamping Voltage for 10mm Parts

V10x11P - V10x40P

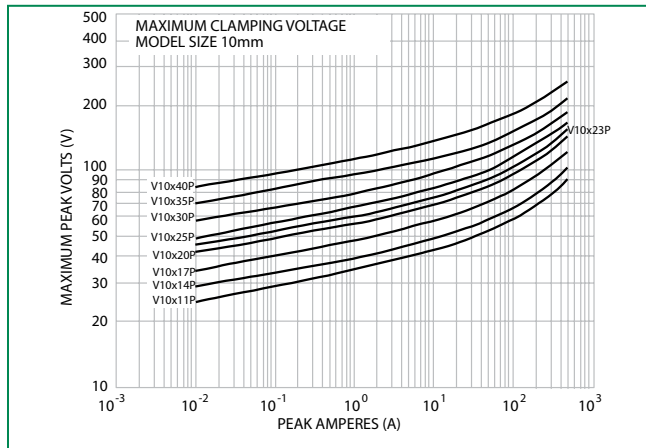

Maximum Clamping Voltage for 14mm Parts

V14x11P - V14x40P

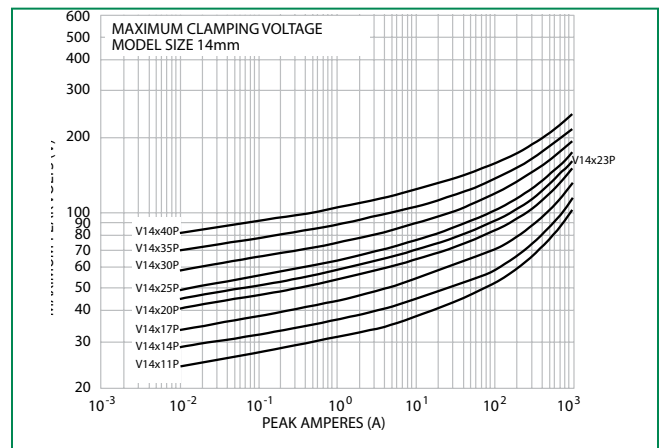

Maximum Clamping Voltage for 20mm Parts

V20x11P - V20x40P

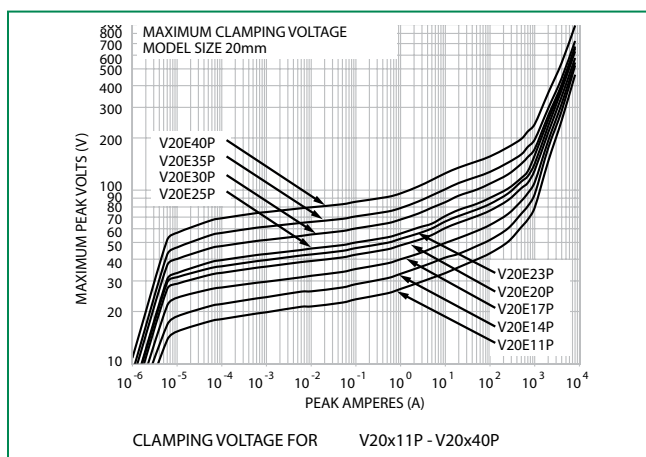

Maximum Clamping Voltage for 5mm Parts

V05x50P - V05x95P

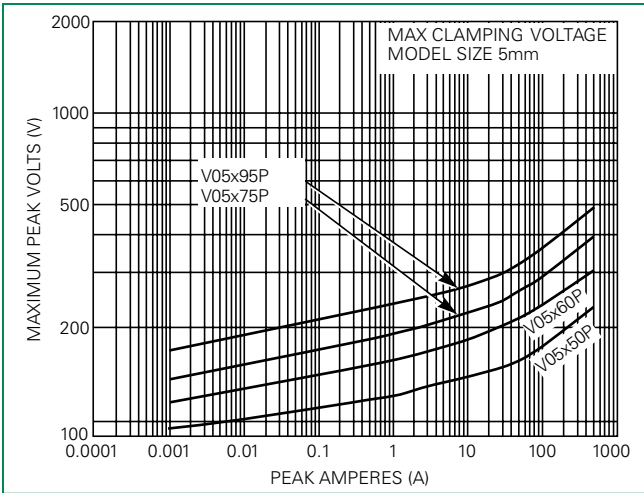

Maximum Clamping Voltage for 7mm Parts

V07x50P - V07x95P

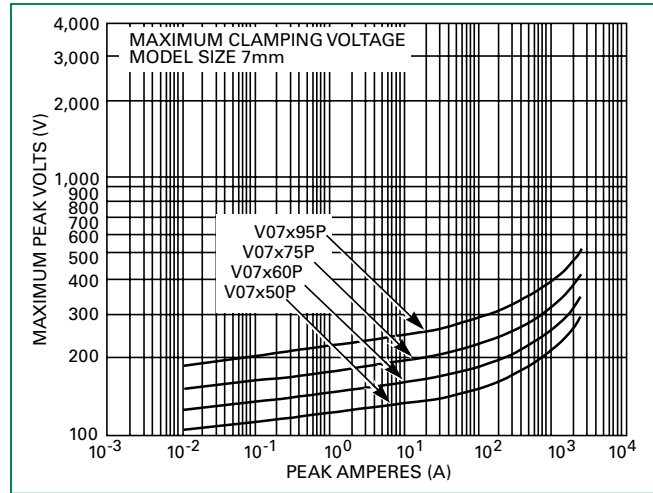

Maximum Clamping Voltage for 10mm Parts

V10x50P - V10x95P

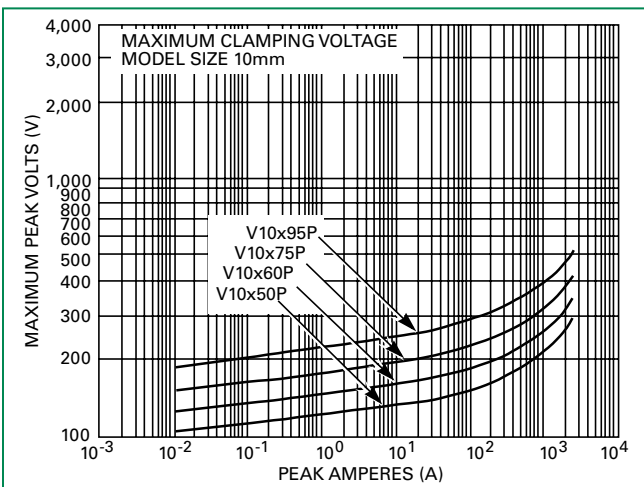

Maximum Clamping Voltage for 14mm Parts

V14x50P - V14x95P

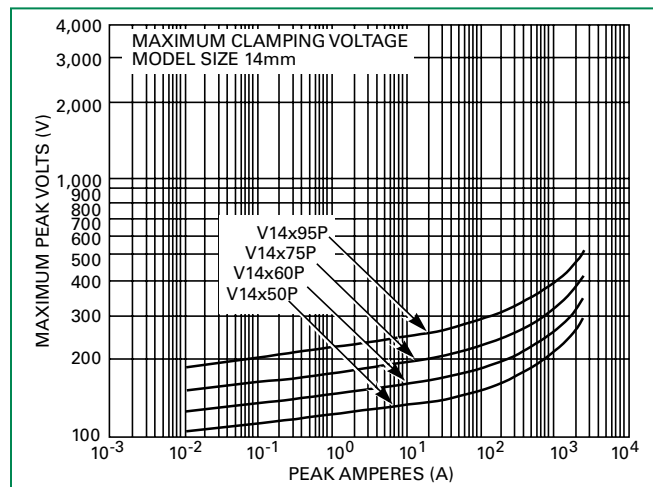

Maximum Clamping Voltage for 20mm Parts

V20x50P - V20x95P

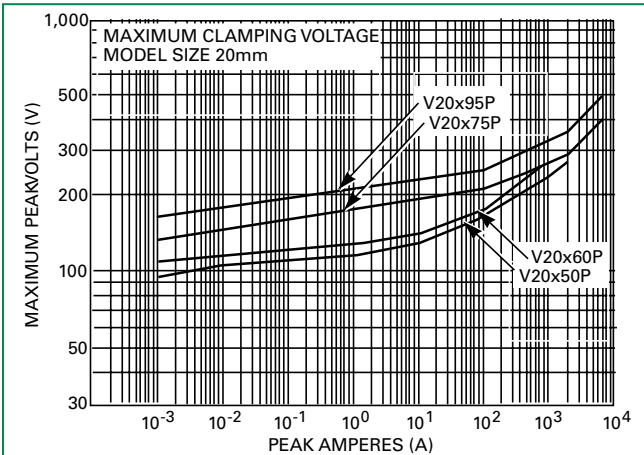

Repetitive Surge Capability for 5mm Parts

V05x11P - V05x40P

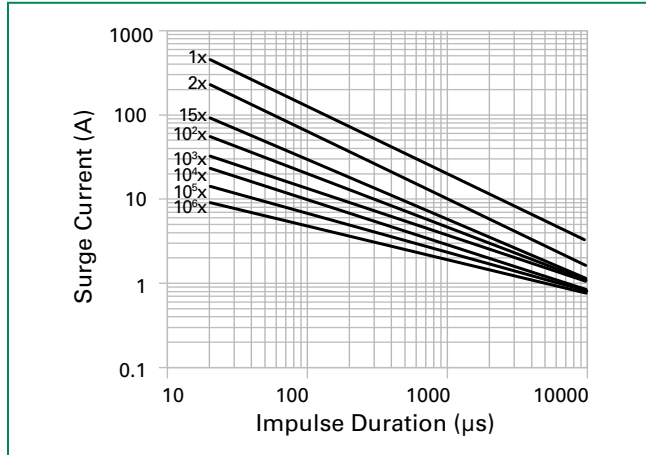

Repetitive Surge Capability for 7mm Parts

V07x11P - V07x40P

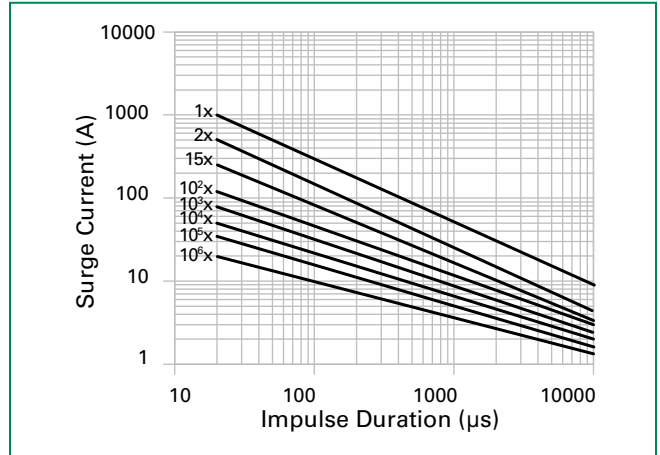

Repetitive Surge Capability for 10mm Parts

V10x11P - V10x40P

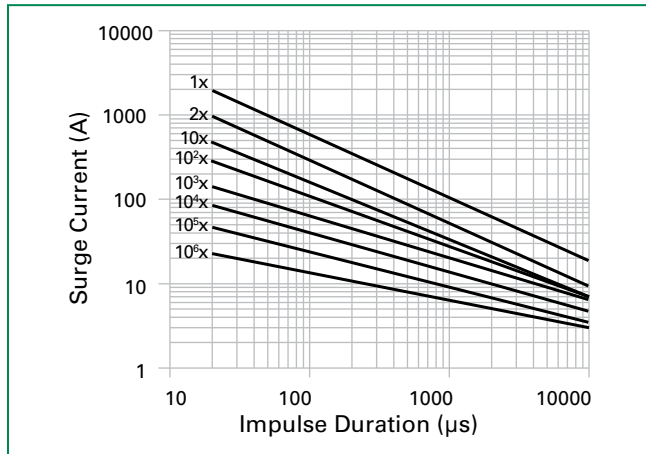

Repetitive Surge Capability for 14mm Parts

V14x11P - V14x40P

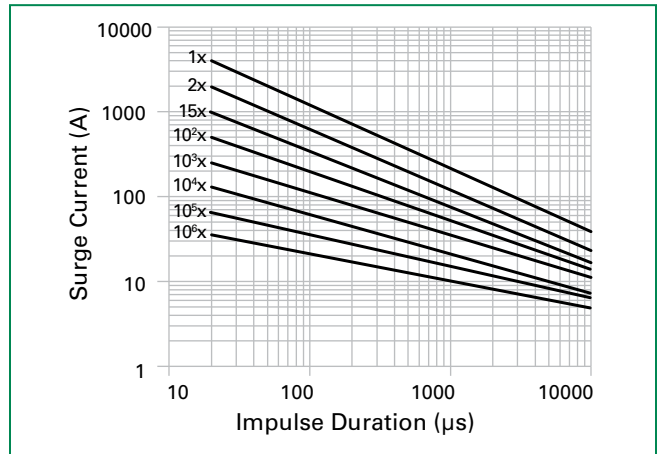

Repetitive Surge Capability for 20mm Parts

V20x11P - V20x40P

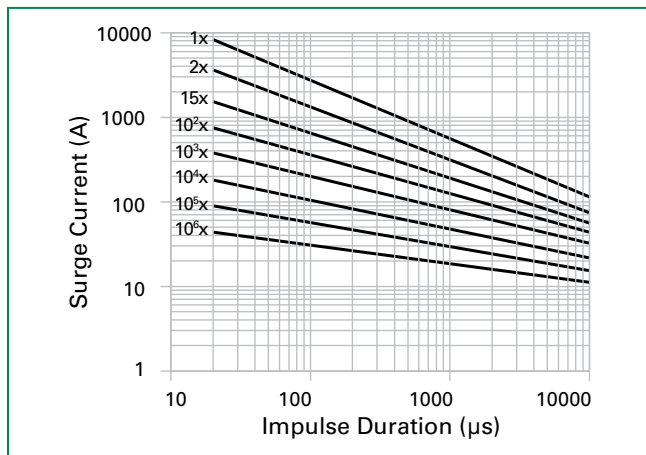

NOTE: If pulse ratings are exceeded, a shift of V_{NIDCI} (at specified current) of more than +/-10% could result. This type of shift, which normally results in a decrease of V_{NIDCI} , may result in the device not meeting the original published specifications, but does not prevent the device from continuing to function, and to provide ample protection.

Repetitive Surge Capability for 5mm Parts

V05x50P - V05x95P

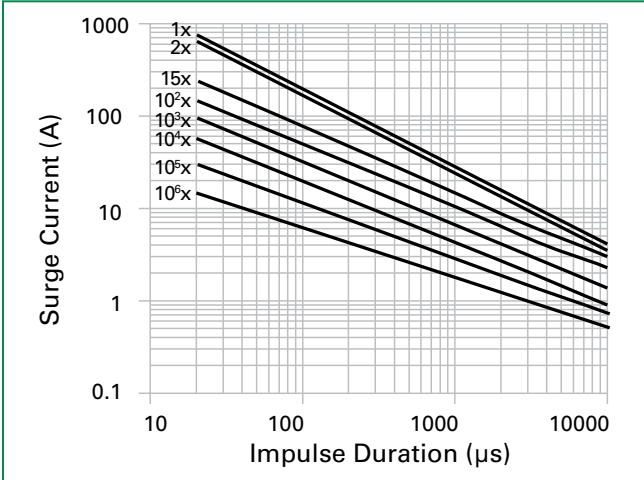

Repetitive Surge Capability for 7mm Parts

V07x50P - V07x95P

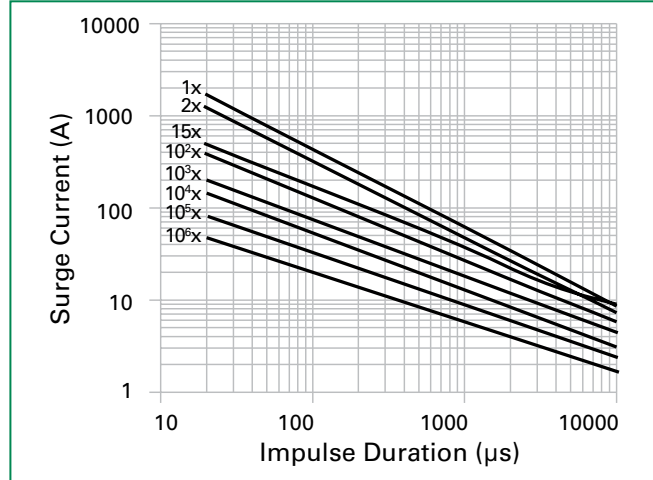

Repetitive Surge Capability for 10mm Parts

V10x50P - V10x95P

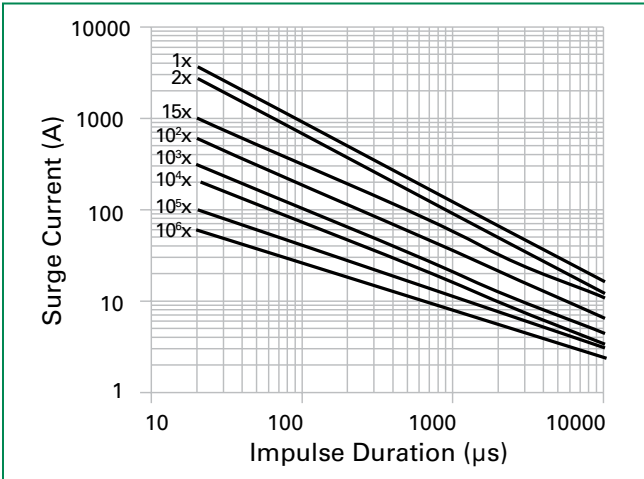

Repetitive Surge Capability for 14mm Parts

V14x50P - V14x95P

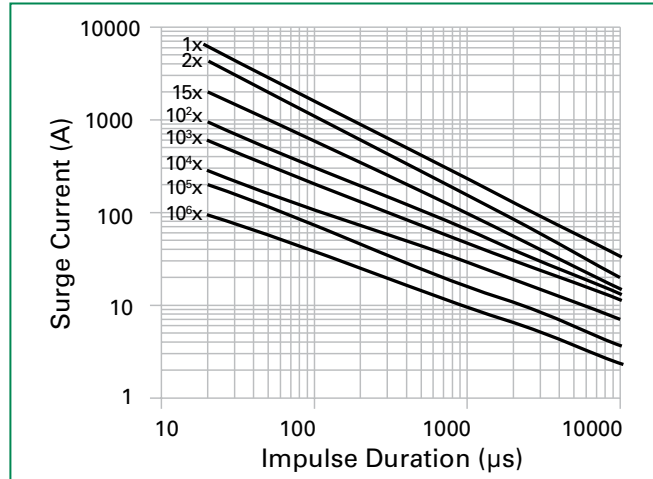

Repetitive Surge Capability for 20mm Parts

V20x50P - V20x95P

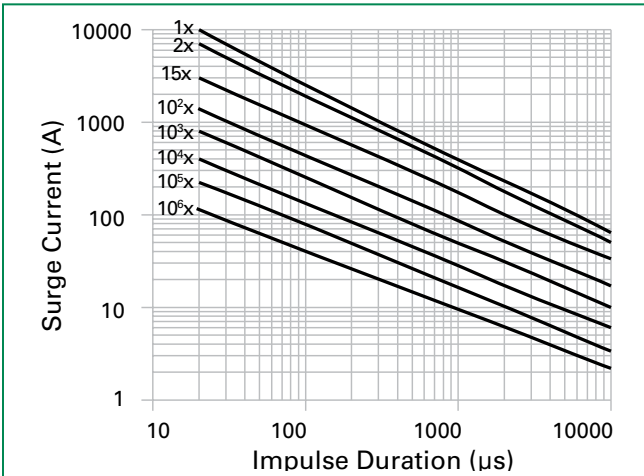

Wave Solder Profile

Non Lead-free Profile

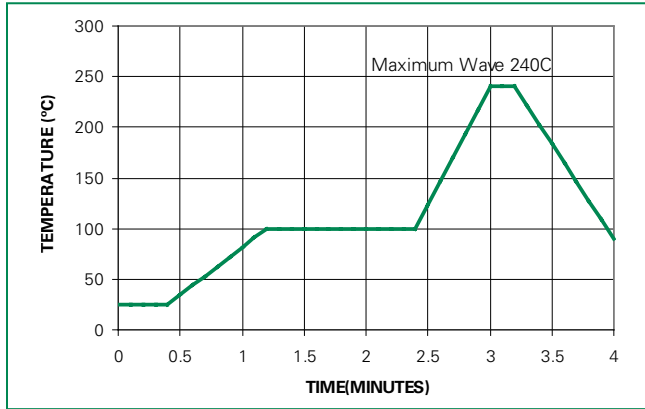

Lead-free Profile



Physical Specifications

Lead Material	Copper Clad Steel Wire
Soldering Characteristics	Solderability per MIL-STD-202, Method 208
Insulating Material	Cured, flame retardant epoxy polymer meets UL94V-0 requirements
Device Labeling	Marked with LF, voltage and date code

Environmental Specifications

Humidity Aging	+85°C, 85% RH, 1000 hours +/-10% typical voltage change
Thermal Shock	+85°C to -40°C 10 times +/-10% typical voltage change
Solvent Resistance	MIL-STD-202, Method 215
Moisture Sensitivity	Level 1, J-STD-020

Product Dimensions (mm)

Straight Lead

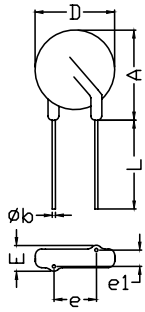

Outer Crimp Lead

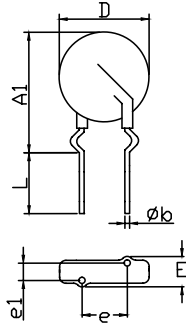

In-Line (Under Crimp) Lead

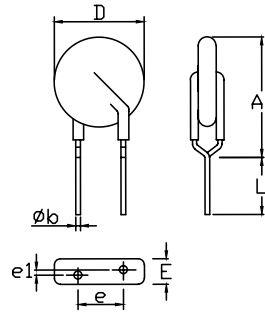

Inner Crimp Lead

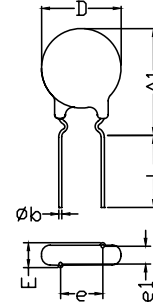

Dimension	V _{RMS} Voltage Model	5mm Size		7mm Size		10mm Size		14mm Size		20mm Size	
		Min. mm (in)	Max. mm (in)	Min. mm (in)	Max. mm (in)	Min. mm (in)	Max. mm (in)	Min. mm (in)	Max. mm (in)	Min. mm (in)	Max. mm (in)
A	All	-	10 (0.394)	-	12 (0.472)	-	16 (0.630)	-	20 (0.787)	-	26.5 (1.043)
A1	All	-	13 (0.512)	-	15 (0.591)	-	19.5 (0.768)	-	22.5 (0.886)	-	29 (1.142)
ØD	All	-	7 (0.276)	-	9 (0.354)	-	12.5 (0.492)	-	17 (0.669)	-	23 (0.906)
e	All	4 (0.157)	6 (0.236)	4 (0.157)	6 (0.236)	6.5 (0.256)	8.5 (0.335)	6.5 (0.256)	8.5 (0.335)	6.5 (0.256)	8.5 (0.335)
e₁	11 - 30	1 (0.039)	3 (0.118)	1 (0.039)	3 (0.118)	1 (0.039)	3 (0.118)	1 (0.039)	3 (0.118)	1 (0.039)	3 (0.118)
	35 - 95	1.5 (0.059)	3.5 (0.138)	1.5 (0.059)	3.5 (0.138)	1.5 (0.059)	3.5 (0.138)	1.5 (0.059)	3.5 (0.138)	1.5 (0.059)	3.5 (0.138)
E	11 - 30	-	5.0 (0.197)	-	5.0 (0.197)	-	5.0 (0.197)	-	5.0 (0.197)	-	5.0 (0.197)
	35 - 95	-	5.6 (0.220)	-	5.6 (0.220)	-	5.6 (0.220)	-	5.6 (0.220)	-	5.6 (0.220)
øb	All	0.585 (0.023)	0.685 (0.027)	0.585 (0.023)	0.685 (0.027)	0.76 (0.030)	0.86 (0.034)	0.76 (0.030)	0.86 (0.034)	0.76 (0.030)	0.86 (0.034)
L	All	25.4 (1.00)	-	25.4 (1.00)	-	25.4 (1.00)	-	25.4 (1.00)	-	25.4 (1.00)	-
L_{TRIM}	All	2.41 (0.095)	4.69 (0.185)	2.41 (0.095)	4.69 (0.185)	2.41 (0.095)	4.69 (0.185)	2.41 (0.095)	4.69 (0.185)	2.41 (0.095)	4.69 (0.185)

Tape and Reel Specifications

5 and 7mm Devices

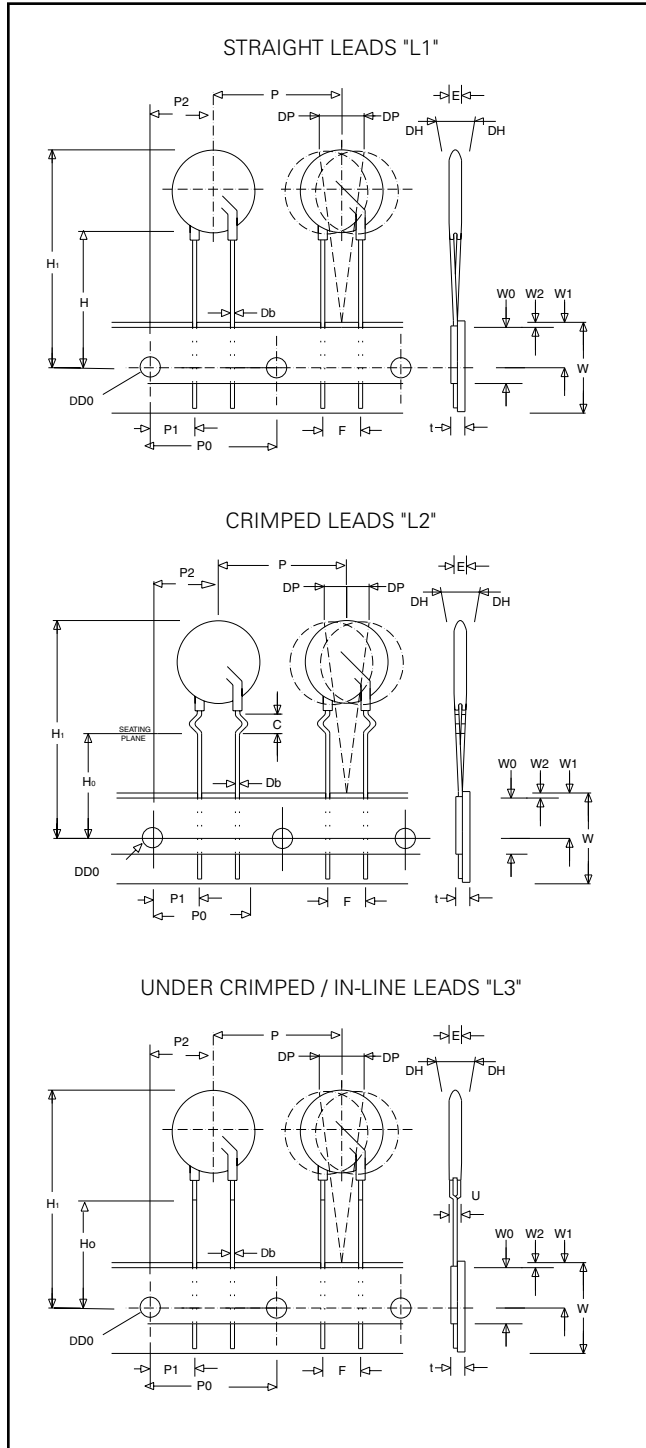

10, 14, and 20mm Devices

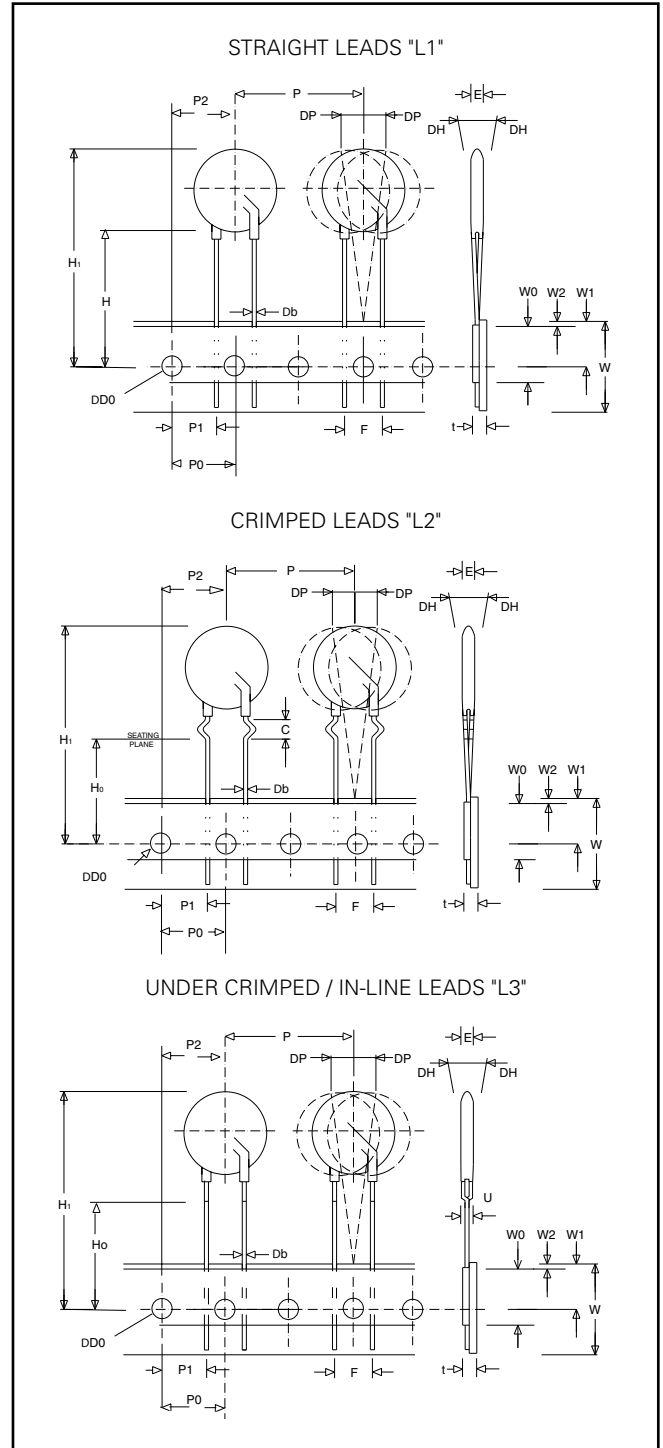

Refer to next page for dimension measurement specifics.

Tape and Reel Specifications (continued)

NOTES:

- Radial devices on tape are supplied with crimped leads, straight leads, or under-crimped leads
- Leads are offset by product dimension e1
- Conforms to ANSI and EIA specifications
- Can be supplied to IEC Publication 286-2

SYMBOL	DESCRIPTION	MODEL SIZE				
		5mm	7mm	10mm	14mm	20mm
P	Pitch of Component	12.7 +/- 1.0	12.7 +/- 1.0	25.4 +/- 1.0	25.4 +/- 1.0	25.4 +/- 1.0
P₀	Feed Hole Pitch	12.7 +/- 0.2	12.7 +/- 0.2	12.7 +/- 0.2	12.7 +/- 0.2	12.7 +/- 0.2
P₁	Feed Hole Center to Pitch	3.85 +/- 0.7	3.85 +/- 0.7	8.85 +/- 0.7	8.85 +/- 0.7	8.85 +/- 0.7
P₂	Hole Center to Component Center	6.35 +/- 1.0	6.35 +/- 1.0	12.7 +/- 0.7	12.7 +/- 0.7	12.7 +/- 0.7
F	Lead to Lead Distance	5.0 +/- 1.0	5.0 +/- 1.0	7.5 +/- 1.0	7.5 +/- 1.0	7.5 +/- 1.0
h	Component Alignment	2.0 Max	2.0 Max	2.0 Max	2.0 Max	2.0 Max
W	Tape Width	18.0 +1.0 / -0.5	18.0 +1.0 / -0.5	18.0 +1.0 / -0.5	18.0 +1.0 / -0.5	18.0 +1.0 / -0.5
W₀	Hold Down Tape Width	12.0 +/- 0.3	12.0 +/- 0.3	12.0 +/- 0.3	12.0 +/- 0.3	12.0 +/- 0.3
W₁	Hole Position	9.0 +0.75 / -0.50	9.0 +0.75 / -0.50	9.0 +0.75 / -0.50	9.0 +0.75 / -0.50	9.0 +0.75 / -0.50
W₂	Hold Down Tape Position	0.5 Max	0.5 Max	0.5 Max	0.5 Max	0.5 Max
H	Height from Tape Center to Component Base	18.0 +2.0 / -0.0	18.0 +2.0 / -0.0	18.0 +2.0 / -0.0	18.0 +2.0 / -0.0	18.0 +2.0 / -0.0
H₀	Seating Plane Height	16.0 +/- 0.5	16.0 +/- 0.5	16.0 +/- 0.5	16.0 +/- 0.5	16.0 +/- 0.5
H₁	Component Height	29.0 Max	32.0 Max	36.0 Max	40.0 Max	46.5 Max
D₀	Feed Hole Diameter	4.0 +/- 0.2	4.0 +/- 0.2	4.0 +/- 0.2	4.0 +/- 0.2	4.0 +/- 0.2
t	Total Tape Thickness	0.7 +/- 0.2	0.7 +/- 0.2	0.7 +/- 0.2	0.7 +/- 0.2	0.7 +/- 0.2
U	Undercrimp Width	8.0 Max	8.0 Max	8.0 Max	8.0 Max	8.0 Max
p	Component Alignment	3° Max	3° Max	3° Max	3° Max	3° Max

Part Numbering System

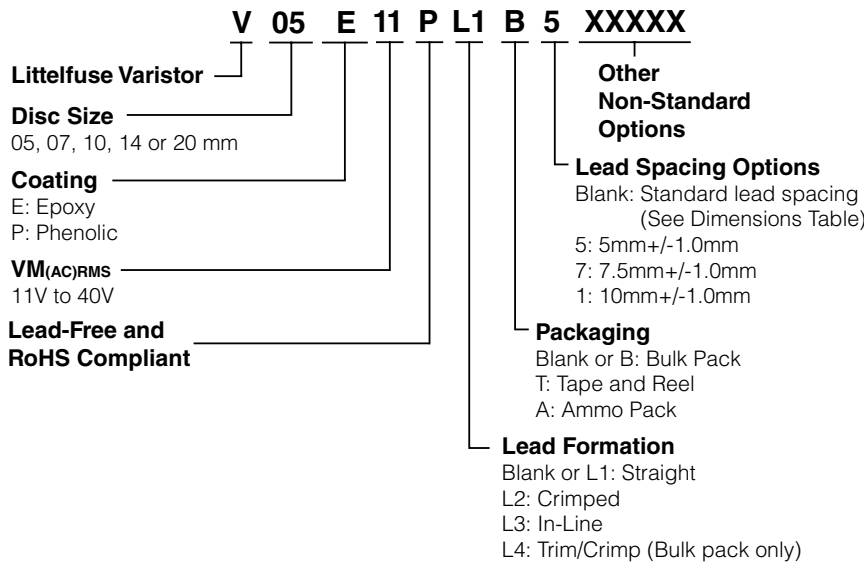



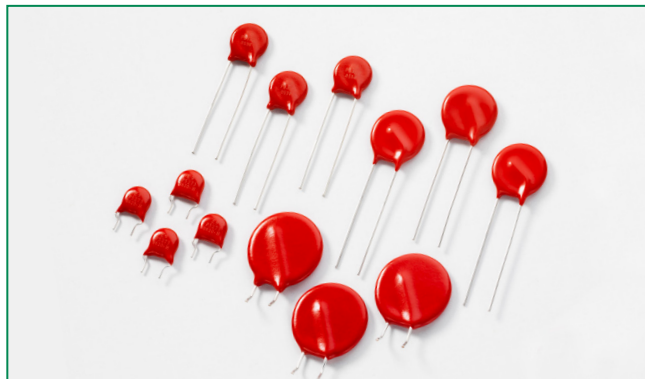

OPTION CODES:
X2855: Nickel Barrier COATED WIRE OPTION --
All standard parts use tinned copper clad steel wire. Nickel Barrier Coated wire is available as an option, consisting of Copper wire with a flashing of Nickel followed by a top coating of Tin. To order append standard model BASE PART number with "X2855".
Example:
Standard Model: Order As:
V05P11P V05P11PX2855

Disclaimer Notice - Information furnished is believed to be accurate and reliable. However, users should independently evaluate the suitability of and test each product selected for their own applications. Littelfuse products are not designed for, and may not be used in, all applications. Read complete Disclaimer Notice at www.littelfuse.com/disclaimer-electronics.

UltraMOV® Varistor Series



Agency Approvals

Agency	Agency Approval	Agency File Number
	UL1449	E320116 ³
	CECC 42201-006 IEC 61051-1 IEC 61051-2 IEC 60950-1 (Annex Q) for 14mm and 20mm only	116895 ¹
	CSA C22.2 No. 1	91788
	CECC 42201-006 IEC 61051-1 IEC 61051-2 IEC 60950-1 (Annex Q) for 10mm, 14mm and 20mm only	IECQ-C BSI 14.0001 ¹
	IEC/EN 61051-1 IEC 61051-2 IEC 61051-2-2 IEC 60950-1 (Annex Q) for 10mm, 14mm and 20mm only	J 50324242 ²

Notes:

- Epoxy coated only.
- Phenolic coated only.
- All epoxy coated sizes are UL Recognized while only 10mm, 14mm, and 20mm phenolic coated parts are UL recognized.

Description

The UltraMOV® Metal Oxide Varistor Series is designed for applications requiring high peak surge current ratings and high energy absorption capability. UltraMOV® varistors are primarily intended for use in AC Line Voltage applications such as Surge Protection Device (SPD), Uninterruptable Power Supplies (UPS), AC Power Taps, AC Power Meters, or other products that require voltage clamping of high transient surge currents from sources such as lightning, inductive load switching, or capacitor bank switching.

These devices are produced in radial lead package sizes of 7, 10, 14 and 20mm and offered in a variety of lead forms. UltraMOV® varistor are manufactured with recognized epoxy encapsulation and are rated for ambient temperatures up to 85°C with no derating. This Series is LASER-branded and is supplied in bulk, ammo pack (fan-fold), or tape and reel packaging.

Features

- Lead-free, Halogen-Free and RoHS compliant
- High peak surge current rating (I_{TM}) up to 10kA, single 8 x 20 pulse, (20mm)
- Standard operating voltage range compatible with common AC line voltages (130 V_{AC} to 625 V_{AC})
- Characterized for maximum standby current (Leakage)
- Custom voltage types available
- Standard lead form and lead space options
- High operating temperature range up to 125°C (phenolic coating option). 10mm, 14mm and 20mm devices are UL Recognized and TUV certified with 800V isolation voltage rating

Absolute Maximum Ratings

- For ratings of individual members of a series, see Device Ratings and Specifications chart

Continuous	UltraMOV® Varistor Series	Units
Steady State Applied Voltage:		
AC Voltage Range ($V_{MIAC,RMS}$)	130 to 625	V
Transients:		
Single-Pulse Peak Current (I_{TM}) 8x20µs Wave (See Figure 2)	1,750 to 10,000	A
Single-Pulse Energy Range (W_{TM}) 2ms Square Wave	12.5 to 400	J
Operating Ambient Temperature Range (T_A) for Epoxy coated	-55 to +85	°C
Operating Ambient Temperature Range (T_A) for Phenolic coated	-55 to +125	°C
Storage Temperature Range (T_{STG}) for Epoxy coated	-55 to +125	°C
Storage Temperature Range (T_{STG}) for Phenolic coated	-55 to +150	°C
Temperature Coefficient (α) of Clamping Voltage (V_C) at Specified Test Current	<0.01	%/°C
Hi-Pot Encapsulation (COATING Isolation Voltage Capability)	2500	V
COATING Insulation Resistance	1000	MΩ

CAUTION: Stresses above those listed in "Absolute Maximum Ratings" may cause permanent damage to the device. This is a stress only rating and operation of the device at these or any other conditions above those indicated in the operational sections of this specification is not implied.

UltraMOV® Series Ratings & Specifications

Epoxy Coated Models		Phenolic Coated Models		Maximum Rating (85°C)					Specifications (25°C)				
				Continuous		Transient			Varistor Voltage at 1mA DC Test Current		Maximum Clamping Voltage 8 x 20µs		Typical Capacitance
Part Number	Branding	Part Number	Branding	RMS Volts	DC Volts	Energy 2ms	Peak Current 8 x 20µs						
				V _{M(AC)}	V _{M(DC)}	W _{TM}	I _{TM} 1 x Pulse	I _{TM} 2 x Pulse	(V)	(V)	(V)	(A)	(pF)
V07E130P	P7V130	V07P130P	P7P130	130	170	12.5	1750	1200	184.5	225.5	340	10	180
V10E130P	P10V130	V10P130P	P10P130	130	170	25	3500	2500	184.5	225.5	340	25	450
V14E130P	P14V130	V14P130P	P14P130	130	170	50	6000	4500	184.5	225.5	340	50	1000
V20E130P	P20V130	V20P130P	P20P130	130	170	100	10000	6500	184.5	225.5	340	100	1900
V07E140P	P7V140	V07P140P	P7P140	140	180	13.5	1750	1200	198	242	360	10	160
V10E140P	P10V140	V10P140P	P10P140	140	180	27.5	3500	2500	198	242	360	25	400
V14E140P	P14V140	V14P140P	P14P140	140	180	55	6000	4500	198	242	360	50	900
V20E140P	P20V140	V20P140P	P20P140	140	180	110	10000	6500	198	242	360	100	1750
V07E150P	P7V150	V07P150P	P7P150	150	200	15	1750	1200	216	264	395	10	150
V10E150P	P10V150	V10P150P	P10P150	150	200	30	3500	2500	216	264	395	25	360
V14E150P	P14V150	V14P150P	P14P150	150	200	60	6000	4500	216	264	395	50	800
V20E150P	P20V150	V20P150P	P20P150	150	200	120	10000	6500	216	264	395	100	1600
V07E175P	P7V175	V07P175P	P7P175	175	225	17	1750	1200	243	297	455	10	130
V10E175P	P10V175	V10P175P	P10P175	175	225	35	3500	2500	243	297	455	25	350
V14E175P	P14V175	V14P175P	P14P175	175	225	70	6000	4500	243	297	455	50	700
V20E175P	P20V175	V20P175P	P20P175	175	225	135	10000	6500	243	297	455	100	1400
V07E230P	P7V230	V07P230P	P7P230	230	300	20	1750	1200	324	396	595	10	100
V10E230P	P10V230	V10P230P	P10P230	230	300	42	3500	2500	324	396	595	25	250
V14E230P	P14V230	V14P230P	P14P230	230	300	80	6000	4500	324	396	595	50	550
V20E230P	P20V230	V20P230P	P20P230	230	300	160	10000	6500	324	396	595	100	1100
V07E250P	P7V250	V07P250P	P7P250	250	320	25	1750	1200	351	429	650	10	90
V10E250P	P10V250	V10P250P	P10P250	250	320	50	3500	2500	351	429	650	25	220
V14E250P	P14V250	V14P250P	P14P250	250	320	100	6000	4500	351	429	650	50	500
V20E250P	P20V250	V20P250P	P20P250	250	320	170	10000	6500	351	429	650	100	1000
V07E275P	P7V275	V07P275P	P7P275	275	350	28	1750	1200	387	473	710	10	80
V10E275P	P10V275	V10P275P	P10P275	275	350	55	3500	2500	387	473	710	25	200
V14E275P	P14V275	V14P275P	P14P275	275	350	110	6000	4500	387	473	710	50	450
V20E275P	P20V275	V20P275P	P20P275	275	350	190	10000	6500	387	473	710	100	900
V07E300P	P7V300	V07P300P	P7P300	300	385	30	1750	1200	423	517	775	10	70
V10E300P	P10V300	V10P300P	P10P300	300	385	60	3500	2500	423	517	775	25	180
V14E300P	P14V300	V14P300P	P14P300	300	385	125	6000	4500	423	517	775	50	400
V20E300P	P20V300	V20P300P	P20P300	300	385	250	10000	6500	423	517	775	100	800
V07E320P	P7V320	V07P320P	P7P320	320	420	32	1750	1200	459	561	840	10	65
V10E320P	P10V320	V10P320P	P10P320	320	420	67	3500	2500	459	561	840	25	170
V14E320P	P14V320	V14P320P	P14P320	320	420	136	6000	4500	459	561	840	50	380
V20E320P	P20V320	V20P320P	P20P320	320	420	273	10000	6500	459	561	840	100	750
V07E385P	P7V385	V07P385P	P7P385	385	505	36	1750	1200	558	682	1025	10	60
V10E385P	P10V385	V10P385P	P10P385	385	505	75	3500	2500	558	682	1025	25	160
V14E385P	P14V385	V14P385P	P14P385	385	505	150	6000	4500	558	682	1025	50	360
V20E385P	P20V385	V20P385P	P20P385	385	505	300	10000	6500	558	682	1025	100	700
V07E420P	P7V420	V07P420P	P7P420	420	560	40	1750	1200	612	748	1120	10	55
V10E420P	P10V420	V10P420P	P10P420	420	560	80	3500	2500	612	748	1120	25	140
V14E420P	P14V420	V14P420P	P14P420	420	560	160	6000	4500	612	748	1120	50	300
V20E420P	P20V420	V20P420P	P20P420	420	560	320	10000	6500	612	748	1120	100	600
V07E440P	P7V440	V07P440P	P7P440	440	585	44	1750	1200	643.5	786.5	1180	10	50
V10E440P	P10V440	V10P440P	P10P440	440	585	85	3500	2500	643.5	786.5	1180	25	130
V14E440P	P14V440	V14P440P	P14P440	440	585	170	6000	4500	643.5	786.5	1180	50	260
V20E440P	P20V440	V20P440P	P20P440	440	585	340	10000	6500	643.5	786.5	1180	100	500
V07E460P	P7V460	V07P460P	P7P460	460	615	48	1750	1200	675	825	1240	10	45
V10E460P	P10V460	V10P460P	P10P460	460	615	90	3500	2500	675	825	1240	25	120

Ratings & Specifications (Continued...)

Epoxy Coated Models		Phenolic Coated Models		Maximum Rating (85°C)					Specifications (25°C)				
				Continuous		Transient			Varistor Voltage at 1mA DC Test Current		Maximum Clamping Voltage 8 x 20µs		Typical Capacitance
Part Number	Branding	Part Number	Branding	RMS Volts	DC Volts	Energy 2ms	Peak Current 8 x 20µs		V _{NOM} Min	V _{NOM} Max	V _C	I _{PK}	f = 1MHz
				V _{M(AC)}	V _{M(DC)}	W _{TM}	I _{TM} 1 x Pulse	I _{TM} 2 x Pulse					
				(V)	(V)	(J)	(A)	(A)	(V)	(V)	(V)	(A)	(pF)
V14E460P	P14V460	V14P460P	P14P460	460	615	180	6000	4500	675	825	1240	50	220
V20E460P	P20V460	V20P460P	P20P460	460	615	360	10000	6500	675	825	1240	100	400
V07E510P	P7V510	V07P510P	P7P510	510	670	52	1750	1200	738	902	1355	10	40
V10E510P	P10V510	V10P510P	P10P510	510	670	92	3500	2500	738	902	1355	25	110
V14E510P	P14V510	V14P510P	P14P510	510	670	185	6000	4500	738	902	1355	50	200
V20E510P	P20V510	V20P510P	P20P510	510	670	365	10000	6500	738	902	1355	100	350
V10E550P	P10V550	V10P550P	P10P550	550	745	95	3500	2500	819	1001	1500	25	100
V14E550P	P14V550	V14P550P	P14P550	550	745	190	6000	4500	819	1001	1500	50	180
V20E550P	P20V550	V20P550P	P20P550	550	745	370	10000	6500	819	1001	1500	100	300
V10E625P	P10V625	V10P625P	P10P625	625	825	100	3500	2500	900	1100	1650	25	90
V14E625P	P14V625	V14P625P	P14P625	625	825	200	6000	4500	900	1100	1650	50	160
V20E625P	P20V625	V20P625P	P20P625	625	825	400	10000	6500	900	1100	1650	100	250

NOTE: 1. Average power dissipation of transients should not exceed 0.25W, 0.4W, 0.6W and 1.0W for 7mm, 10mm, 14mm, and 20mm model sizes, respectively.

Current Energy and Power Dissipation Ratings

Should transients occur in rapid succession, the average power dissipation is the energy (watt-seconds) per pulse times the number of pulses per second. The power so developed must be within the specifications shown on the Device Ratings and Specifications Table for the specific

device. The operating values of a MOV need to be derated at high temperatures as shown above. Because varistors only dissipate a relatively small amount of average power they are not suitable for repetitive applications that involve substantial amounts of average power dissipation.

Figure 1A - Power Derating for Epoxy Coated

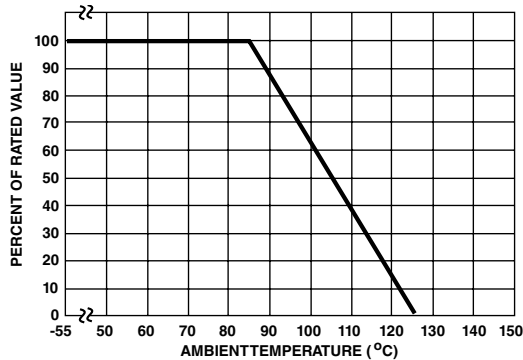
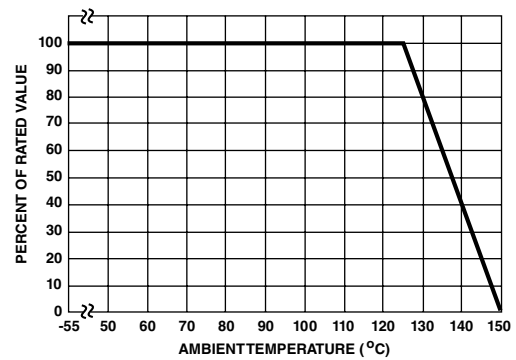
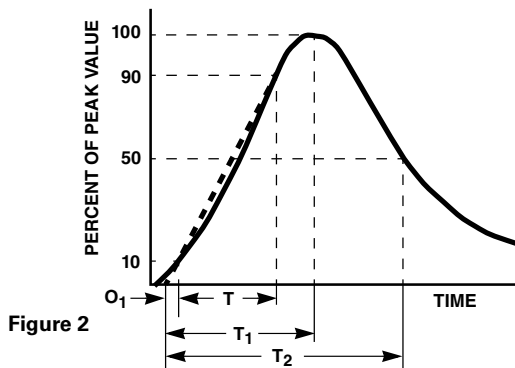

Figure 1B - Power Derating for Phenolic Coated



Peak Pulse Current Test Waveform



O₁ = Virtual Origin of Wave
 T = Time from 10% to 90% of Peak
 T₁ = Rise Time = 1.25 x T
 T₂ = Decay Time
Example - For an 8/20 µs Current Waveform:
 8µs = T₁ = Rise Time
 20µs = T₂ = Decay Time

Transient V-I Characteristics Curves

Maximum Clamping Voltage for 7mm Parts

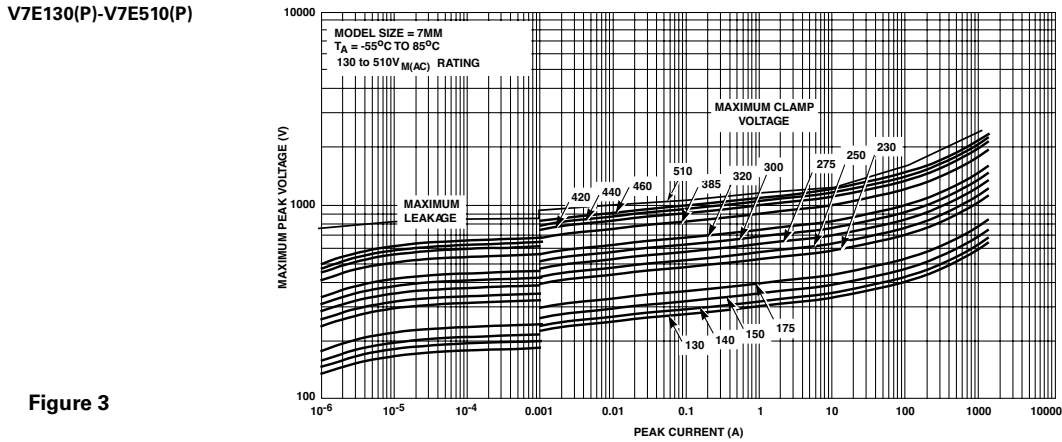

Figure 3

Maximum Clamping Voltage for 10mm Parts

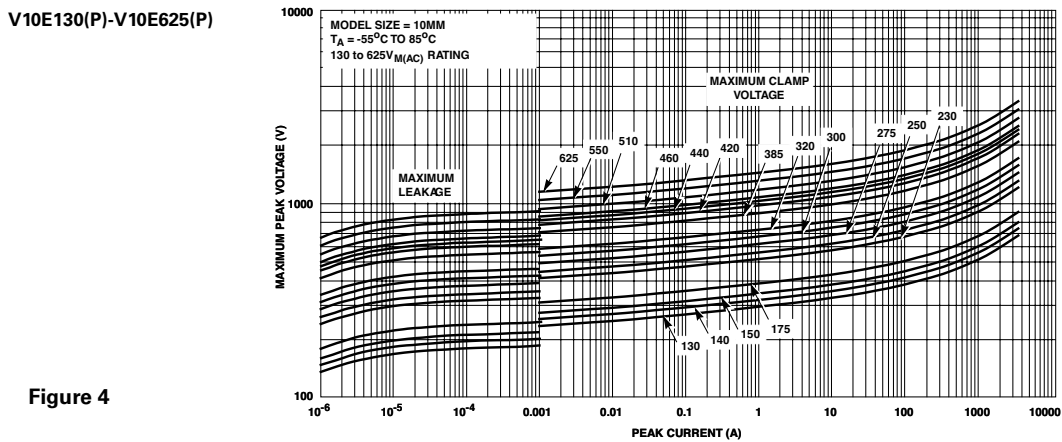

Figure 4

Maximum Clamping Voltage for 14mm Parts

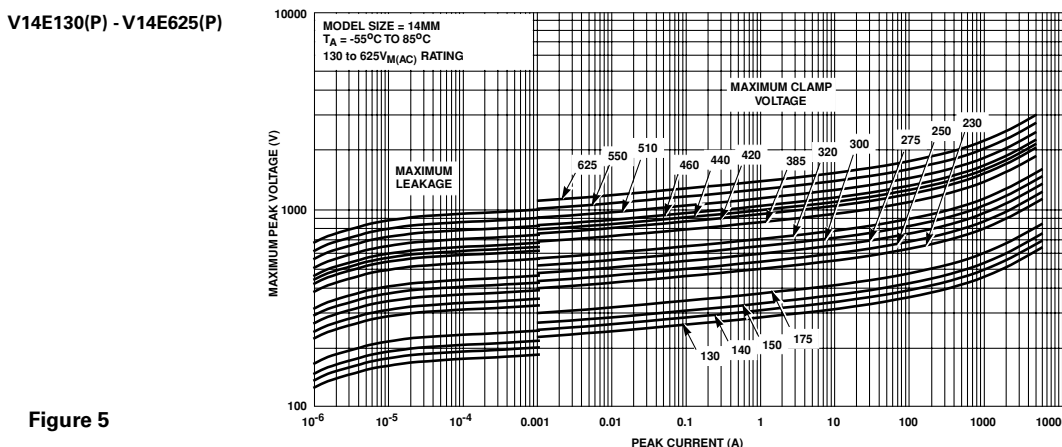

Figure 5

Transient V-I Characteristics Curves

Maximum Clamping Voltage for 20mm Parts

V20E130(P) - V20E625(P)

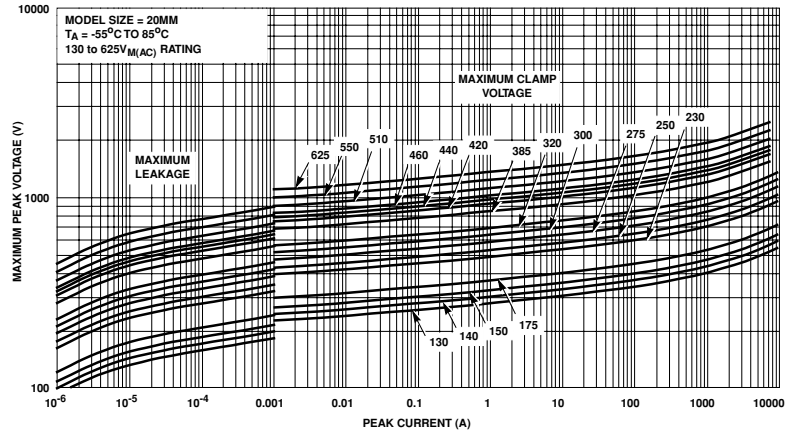

Figure 6

Pulse Rating Curves

Repetitive Surge Capability for 7mm Parts

V7E130(P) - V7E460(P)

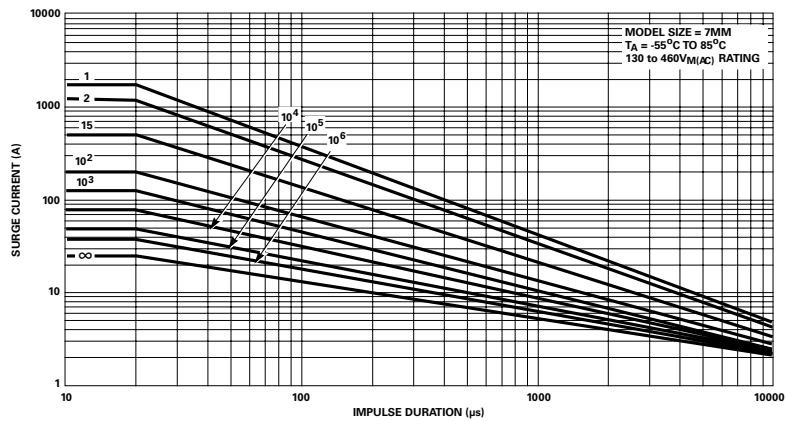

Figure 7

Additional Information



Datasheet



Resources



Samples

Pulse Rating Curves

Repetitive Surge Capability for 10mm Parts

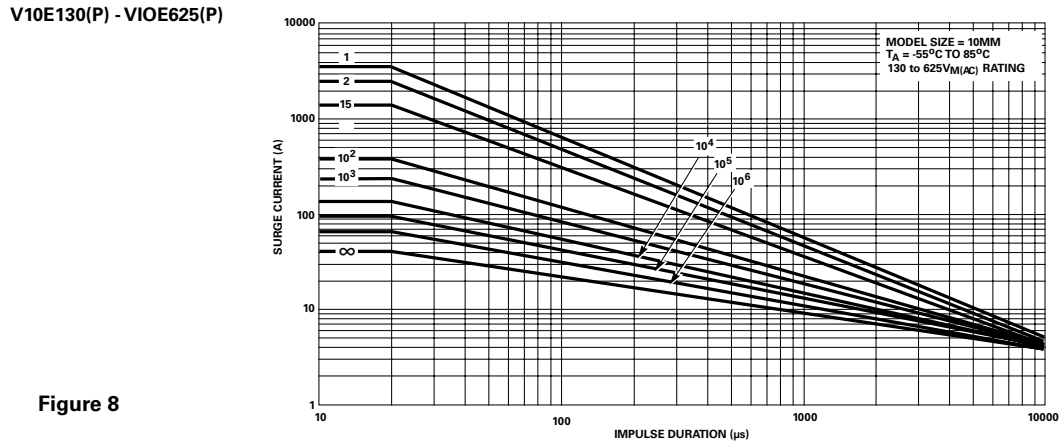

Repetitive Surge Capability for 14mm Parts

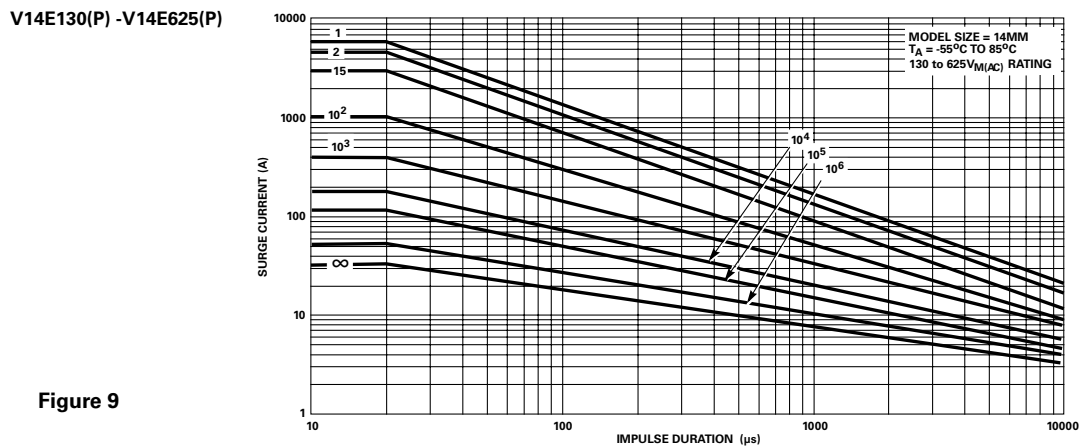

Repetitive Surge Capability for 20mm Parts

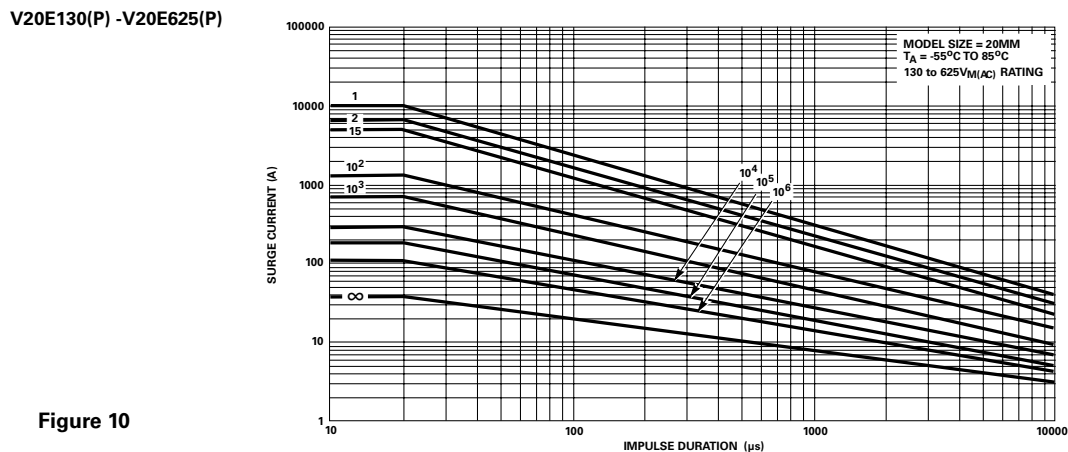

Wave Solder Profile

Non Lead-free Profile

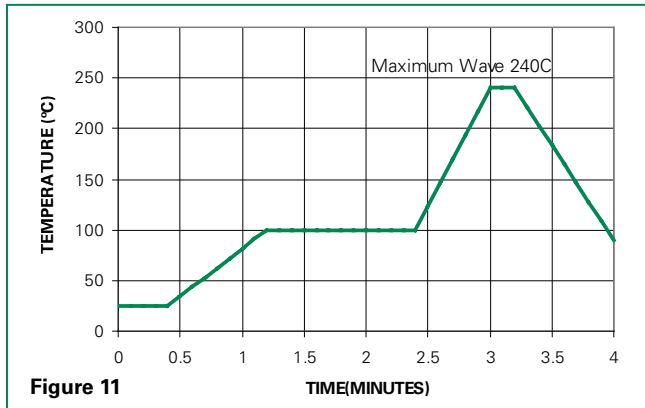

Lead-free Profile

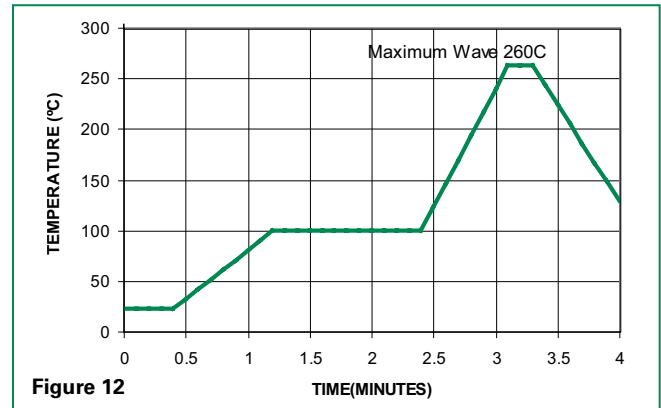

Physical Specifications

Lead Material	Copper Clad Steel Wire
Soldering Characteristics	Solderability per MIL-STD-202, Method 208
Insulating Material	Cured, flame retardant epoxy polymer meets UL94V-0 requirements
Device Labeling	Marked with LF, voltage, UL/CSA logos, and date code

Environmental Specifications

Operating Temperature	-55°C to +85°C
Storage Temperature	-55°C to +125°C
Humidity Aging	+85°C, 85% RH, 1000 hours +/-10% typical voltage change
Thermal Shock	+85°C to -40°C 5 times +/-10% typical voltage change
Solvent Resistance	MIL-STD-202, Method 215
Moisture Sensitivity	Level 1, J-STD-020

Phenolic Coating Option -- UltraMOV® Varistor Series for Hi-Temperature Operating Conditions:

- Phenolic Coated UltraMOV® Varistor Series devices are available with improved maximum operating temperature 125°C.
- These devices also have improved temperature cycling performance capability.
- Ratings and Specifications are as per standard UltraMOV® Series except Hi-Pot Encapsulation (Isolation Voltage Capability) = 800V.
- Phenolic Coating is HALOGEN FREE. To order: change 'E' (Epoxy coating) in part number to 'P' (Phenolic coating; e.g. V20P230)
- See Part Numbering System section of this series for more information.
- Contact factory for further details.
- Product marking:

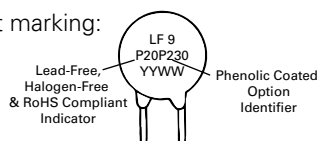

NOTE: 10mm, 14mm and 20mm devices are UL recognized and TUV certified with 800V isolation voltage rating.

Product Dimensions (mm)

Lead form options L1 and L3
(refer to table below)

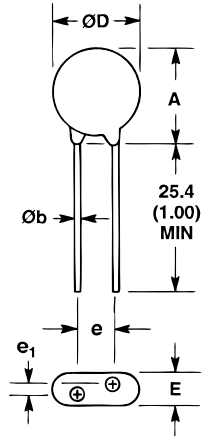

Lead form options L2 and L4
(refer to table below)

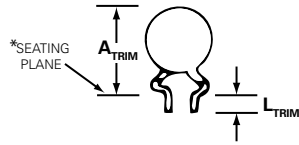

*Seating plane interpretation per IEC-717
(not available on tape or ammo pack)

Dimension	V _{RMS} Voltage Model	7mm Size		10mm Size		14mm Size		20mm Size	
		Min. mm (in)	Max. mm (in)	Min. mm (in)	Max. mm (in)	Min. mm (in)	Max. mm (in)	Min. mm (in)	Max. mm (in)
A	130-320	-	12 (0.472)	-	16 (0.630)	-	20 (0.787)	-	26.5 (1.043)
	385-625	-	13 (0.512)	-	17 (0.689)	-	20.5 (0.807)	-	28 (1.102)
ØD	All	-	9 (0.354)	-	12.5 (0.492)	-	17 (0.669)	-	23 (0.906)
e (Note 2)	All	4 (0.157)	6 (0.236)	6.5 (0.256)	8.5 (0.335)	6.5 (0.256)	8.5 (0.335)	9 (0.354)	11 (0.433)
e₁ (Note 3)	130-320	1.5 (0.059)	3.5 (0.138)	1.5 (0.059)	3.5 (0.138)	1.5 (0.059)	3.5 (0.138)	1.5 (0.059)	3.5 (0.138)
	385-625	2.5 (0.098)	5.5 (0.217)	2.5 (0.098)	5.5 (0.217)	2.5 (0.098)	5.5 (0.217)	2.5 (0.098)	5.5 (0.217)
E	130-320	-	5.6 (0.220)	-	5.6 (0.220)	-	5.6 (0.220)	-	5.6 (0.220)
	385-510	-	7.3 (0.287)	-	7.3 (0.287)	-	7.3 (0.287)	-	7.3 (0.287)
	550-625	-	8.3 (0.327)	-	8.3 (0.327)	-	8.3 (0.327)	-	8.3 (0.327)
Ø b	All	0.585 (0.023)	0.685 (0.027)	0.76 (0.030)	0.86 (0.034)	0.76 (0.030)	0.86 (0.034)	0.76 (0.030) (Note 2)	0.86 (0.034) (Note 2)
A_{TRIM}	All	-	15 (0.591)	-	19.5 (0.768)	-	22.5 (0.886)	-	29.0 (1.142)
L (L2)	All	25.4 (1.00)	-	25.4 (1.00)	-	25.4 (1.00)	-	25.4 (1.00)	-
*L (L4)	All	2.41 (0.095)	4.69 (0.185)	2.41 (0.095)	4.69 (0.185)	2.41 (0.095)	4.69 (0.185)	2.41 (0.095)	4.69 (0.185)

- NOTES:
1. Measurements displayed in Millimeters (Inches in parentheses).
 2. Standard lead space.
 3. For in-line lead option L3, dimension e₁ is "zero". Straight lead form option L1 shown.

For information about bulk packaging quantities, please refer to the Ordering Notes section at the end of this document.

Tape Specifications for Reel and Ammo Pack Items (Refer to dimensions on following page)

7mm Devices

CRIMPED LEADS "L2"

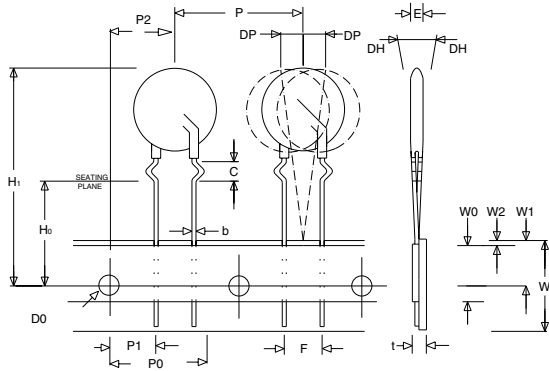

10, 14 and 20mm Devices

CRIMPED LEADS "L2"

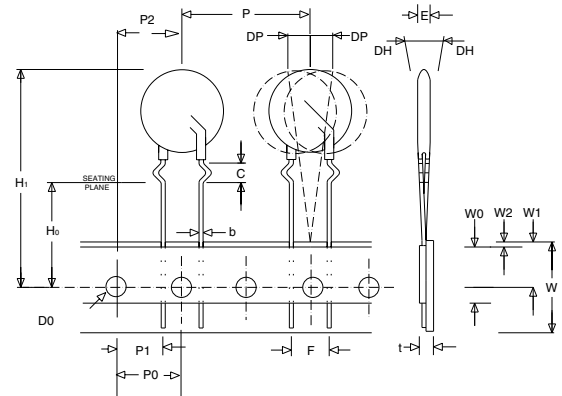

INLINE LEADS "L3"

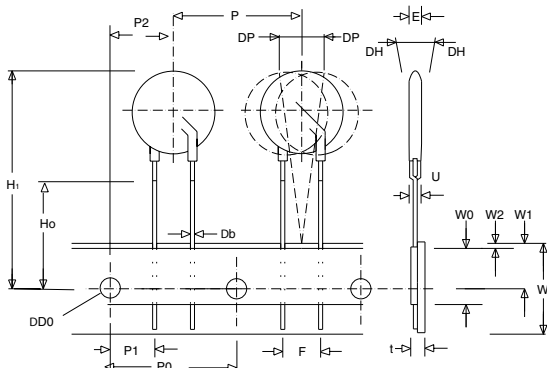

INLINE LEADS "L3"

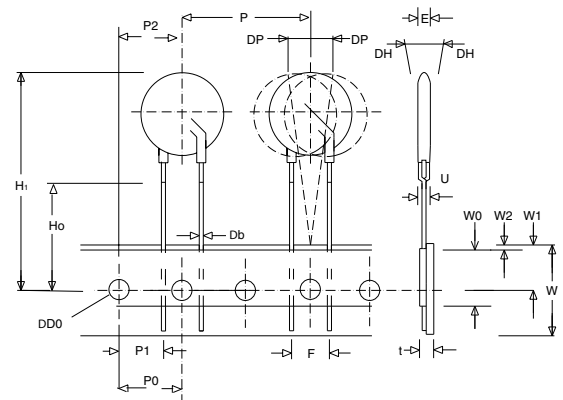

STRAIGHT LEADS "L1"

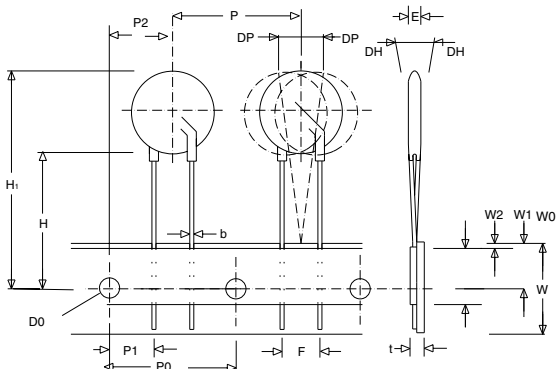

STRAIGHT LEADS "L1"

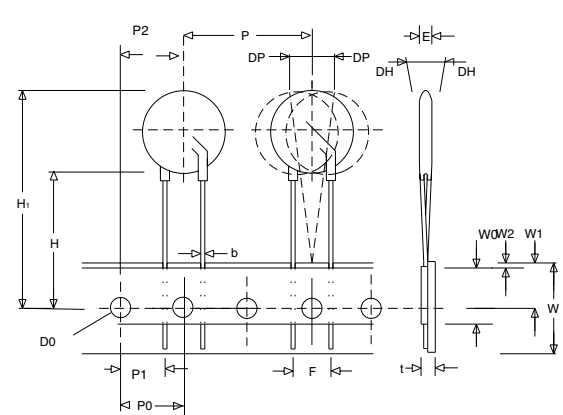

Tape Specifications for Reel and Ammo Pack Items (Refer to drawings on previous page)

- Conforms to ANSI and EIA specifications.
- Can be supplied to IEC Publication 286-2.
- Radial devices on tape are offered with crimped leads, straight leads, or in-line leads. See Ordering Information.
- For 10mm devices 'P' (component pitch) is 12.7mm when 'F' (lead space) is 5mm.
- 7mm parts are available on tape and reel up to 460 VAC only
- 10mm parts are available on tape and reel up to 510 VAC only
- 14mm and 20mm parts are available on tape and reel up to 550 VAC only
- 7mm devices with 7.5mm lead spacing option will be taped at 25.4mm component pitch and 500 pieces per reel
- 10mm devices with 5.0mm lead spacing option will be taped at 12.7mm component pitch and 1000 pieces per reel

Symbol	Description	Model Size			
		7mm	10mm	14mm	20mm
B₁	Component Top to Seating Plane	15 Max	19.5 Max	22.5 Max	29 Max
C	Crimp Length	2.4 Typ	2.6 Typ	2.6 Typ	2.6 Typ
P	Pitch of Component	12.7 +/- 1.0	25.4 +/- 1.0	25.4 +/- 1.0	25.4 +/- 1.0
P₀	Feed Hole Pitch	12.7 +/- 0.2	12.7 +/- 0.2	12.7 +/- 0.2	12.7 +/- 0.2
P₁	Feed Hole Center to Pitch	3.85 +/- 0.7	8.85 +/- 0.7	8.85 +/- 0.7	7.70 +/- 0.7
P₂	Hole Center to Component Center	6.35 +/- 0.7	12.7 +/- 0.7	12.7 +/- 0.7	12.7 +/- 0.7
F	Lead to Lead Distance	5.0 +/- 0.8	7.5 +/- 0.8	7.5 +/- 0.8	10.0 +/- 0.8
Δh	Component Alignment	2.0 Max	2.0 Max	2.0 Max	2.0 Max
W	Tape Width	18.0 +1.0 / -0.5	18.0 +1.0 / -0.52	18.0 +1.0 / -0.5	18.0 +1.0 / -0.5
W₀	Hold Down Tape Width	12.0 +/- 0.3	12.0 +/- 0.3	12.0 +/- 0.3	12.0 +/- 0.3
W₁	Hole Position	9.0 +0.75 / -0.50	9.0 +0.75 / - 0.50	9.0 +0.75 / 0.50	9.0 +0.75 / -0.50
W₂	Hold Down Tape Position	0.5 Max	0.5 Max	0.5 Max	0.5 Max
H	Height from Tape Center to Component Base	18.0 +2.0 / -0.0	18.0 +2.0 / -0.0	18.0 +2.0 / -0.0	18.0 +2.0 / -0.0
H₀	Seating Plane Height	16.0 +/- 0.5	16.0 +/- 0.5	16.0 +/- 0.5	16.0 +/- 0.5
H₁	Component Height	32.0 Max	36.0 Max	40.0 Max	46.5 Max
D₀	Feed Hole Diameter	4.0 +/- 0.2	4.0 +/- 0.2	4.0 +/- 0.2	4.0 +/- 0.2
t	Total Tape Thickness	0.7 +/- 0.2	0.7 +/- 0.2	0.7 +/- 0.2	0.7 +/- 0.2
Δp	Component Alignment	3° Max, 1.00mm	3° Max, 1.00mm	3° Max, 1.00mm	3° Max, 1.00mm

For information on tape and reel packaging quantities, please refer to the Ordering Notes section at the end of this document.

Disclaimer Notice - Information furnished is believed to be accurate and reliable. However, users should independently evaluate the suitability of and test each product selected for their own applications. Littelfuse products are not designed for, and may not be used in, all applications. Read complete Disclaimer Notice at www.littelfuse.com/disclaimer-electronics.

Part Numbering System

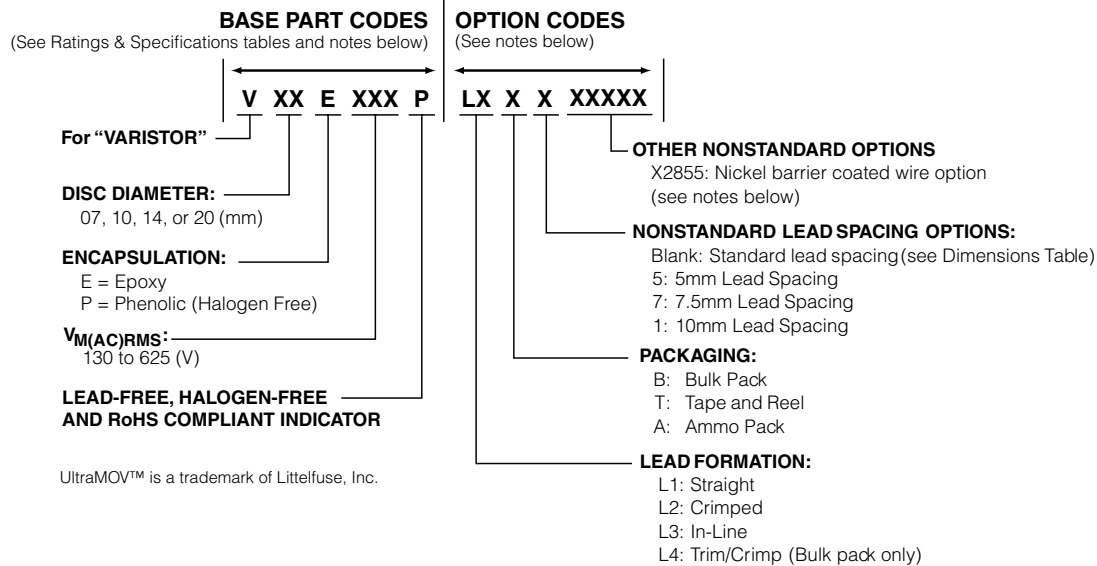

Ordering Notes:

For standard parts, use the **BASE PART** designator only.

For parts with non-standard options (such as additional form, packaging and lead space options) use, **BASE PART + OPTION CODE**.

OPTION CODE items are subject to availability and minimum order requirements. Please contact a Littelfuse representative if you require additional information

OPTION CODES:

X2855: Nickel Barrier COATED WIRE OPTION

All standard parts use tinned copper clad steel wire. Nickel Barrier Coated Wire is available as an option, consisting of Copper Wire with a flashing of Nickel followed by a top coating of Tin.

To order: append standard model **BASE PART** number with "X2855." Example:

Standard Model	Order As
V18ZA40P	V18ZA40PX2855

PACKAGING:

Littelfuse UltraMOV® varistors are shipped standard in bulk pack with straight leads and lead spacing outlined in the dimensions sections of this document. Contact a Littelfuse representative to discuss non-standard options.

Standard Part Default Conditions

Device Size	Part #	Lead Space	Packaging
7mm	V07E-	5.0-/±1	Bulk
10mm	V10E-	7.5-/±1	Bulk
14mm	V14E-	7.5-/±1	Bulk
20mm	V20E-	10.0-/±1	Bulk

Standard Bulk Pack Quantity

Varistor Voltage	Standard Bulk Pack Quantity			
	Varistor Model Size			
	7mm	10mm	14mm	20mm
130 – 275	1500	1000	700	500
300 – 460	1500	700	600	400
510 – 625	1500	700	500	400

Tape & Reel Quantity

Varistor Voltage	Shipping Quantity Per Reel			
	7mm	10mm	14mm	20mm
130 – 275	1000	500	500	500
300 – 625	1000	500	400	400

UltraMOV® 25S Varistor Series

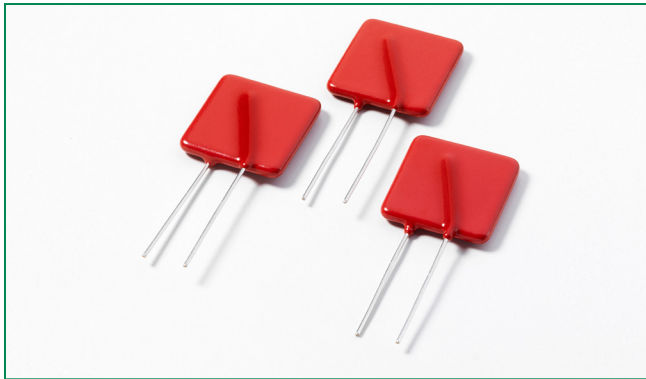



Description

The UltraMOV® 25S Varistor Series is designed for applications requiring high peak surge current ratings and high energy absorption capability. UltraMOV™ varistors are primarily intended for use in AC Line Voltage applications such as Surge Protective Devices (SPD), Uninterruptable Power Supplies (UPS), AC Power Taps, AC Power Meters, or other products that require voltage clamping of high transient surge currents from sources such as lightning, inductive load switching, or capacitor bank switching.

These devices have 25mm square forms are produced in a radial lead package and offered with straight leads. UltraMOV® 25S varistors are manufactured with recognized epoxy encapsulation and are rated for ambient temperatures up to 85°C with no derating. This 25S Series is LASER-branded and is supplied in bulk packaging.

Agency Approvals

Agency	Agency Approval	Agency File Number
	UL1449	E320116
	22.2-1	091788
	IEC 61051-1, IEC61051-2, IEC 60950-1 (Annex Q)	116895

Additional Information



Datashheet



Resources



Samples

Features

- Lead-free and RoHS compliant.
- High peak surge current rating (I_{TM}) 22kA, single 8/20 μ s pulse, (25mm)
- Standard operating voltage range compatible with common AC line voltages (115 to 750VAC)
- Custom voltage types available
- Standard lead form and lead space options

Absolute Maximum Ratings

• For ratings of individual members of a series, see Device Ratings and Specifications chart

Continuous	UltraMOV® 25S Varistor Series	Units
Steady State Applied Voltage:		
AC Voltage Range ($V_{MIACIRMS}$)	115 to 750	V
DC Voltage Range (V_{MDC1})	150 to 970	V
Transients:		
Peak Pulse Current (I_{TM}) 8x20 μ s Current Wave Single Pulse	22,000	A
Single-Pulse Energy Capability (W_{TM}) 2ms Current Wave	230 to 890	J
Operating Ambient Temperature Range (T_A)	-55 to +85	°C
Storage Temperature Range (T_{STG})	-55 to +125	°C
Temperature Coefficient (α^V) of Clamping Voltage (V_C) at Specified Test Current	<0.01	%/C
Hi-Pot Encapsulation (COATING Isolation Voltage Capability)	2500	V
Dielectric Withstand DC for 1 min per MIL-STD-202, Method 301		
Insulation Resistance of the Epoxy Coating	1000	M Ω

CAUTION: Stresses above those listed in "Absolute Maximum Ratings" may cause permanent damage to the device. This is a stress only rating and operation of the device at these or any other conditions above those indicated in the operational sections of this specification is not implied.

Ratings & Specifications

Part Number	Branding	Maximum Rating (85°C)				Specifications (25°C)				
		Continuous		Transient		Varistor Voltage at 1mA DC Test Current		Maximum Clamping Voltage at 100A, 8 x 20µs	UL 1449 Voltage Protection Rating	Typical Capacitance f = 1MHz
		AC Volts	DC Volts	Energy 2ms	Peak Surge Current 8 x 20µs					
		$V_{M(ACIRMS)}$	$V_{M(DC)}$	W_{TM} 1 x Pulse	I_{TM} 1 x Pulse	V_{NOM} Min	V_{NOM} Max	V_C	VPR	C
(V)	(V)	(J)	(A)	(V)		(V)		(pF)		
V25S115P	P25S115	115	150	230	22000	162	198	295	400	4500
V25S130P	P25S130	130	170	255	22000	184.5	225.5	335	500	3900
V25S140P	P25S140	140	180	285	22000	198	242	355	500	3500
V25S150P	P25S150	150	200	300	22000	216	264	390	500	3200
V25S175P	P25S175	175	225	315	22000	243	297	450	600	2550
V25S230P	P25S230	230	300	400	22000	324	396	585	700	1900
V25S250P	P25S250	250	320	435	22000	351	429	640	800	1750
V25S275P	P25S275	275	350	470	22000	387	473	700	900	1610
V25S300P	P25S300	300	385	500	22000	423	517	765	1000	1450
V25S320P	P25S320	320	420	540	22000	459	561	825	1000	1350
V25S385P	P25S385	385	505	630	22000	558	682	1010	1200	1080
V25S420P	P25S420	420	560	655	22000	612	748	1100	1500	1000
V25S440P	P25S440	440	585	675	22000	643.5	786.5	1160	n/a	900
V25S460P	P25S460	460	615	690	22000	675	825	1220	n/a	870
V25S510P	P25S510	510	670	700	22000	738	902	1335	n/a	820
V25S550P	P25S550	550	745	765	22000	819	1001	1475	n/a	750
V25S625P	P25S625	625	825	800	22000	900	1100	1625	n/a	660
V25S750P	P25S750	750	970	890	22000	1080	1320	1950	n/a	550

Note: Average powder dissipation of transients should not exceed 1.5 watts.

Transient V-I Characteristics Curves

Peak Current, Energy and Power Derating Curve

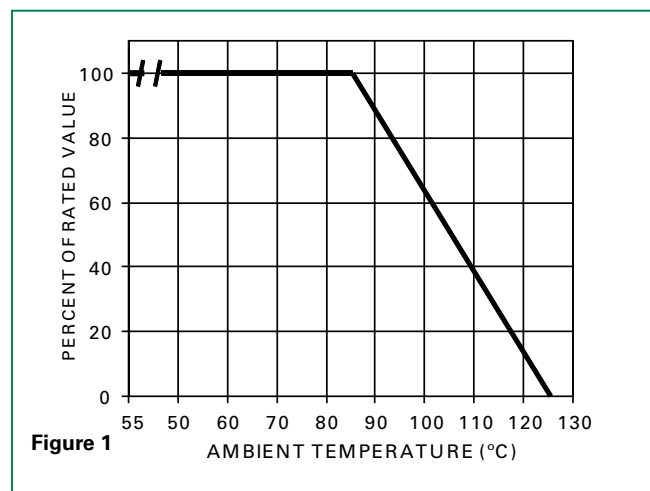

For applications exceeding 85°C ambient temperature, the peak surge current and energy ratings must be reduced as shown above.

Peak Pulse Current Test Waveform for Clamping Voltage

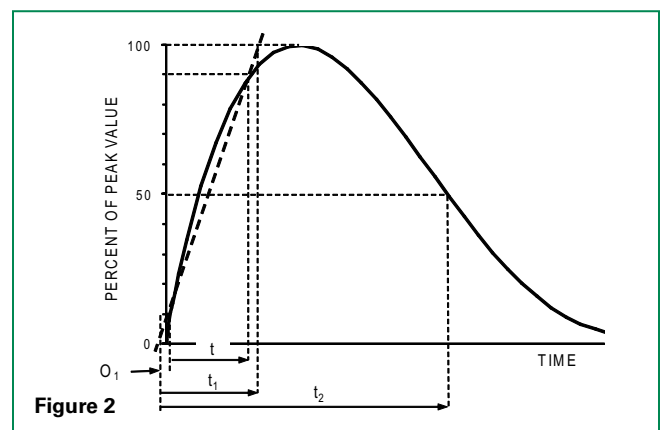

- O_1 = Virtual Origin of Wave
- T = Time from 10% to 90% of Peak
- T_1 = Rise Time = 1.25 x T
- T_2 = Decay Time

Example - For an 8/20 µs Current Waveform:
 $8\mu s = T_1 =$ Rise Time
 $20\mu s = T_2 =$ Decay Time

Transient V-I Characteristic Curve

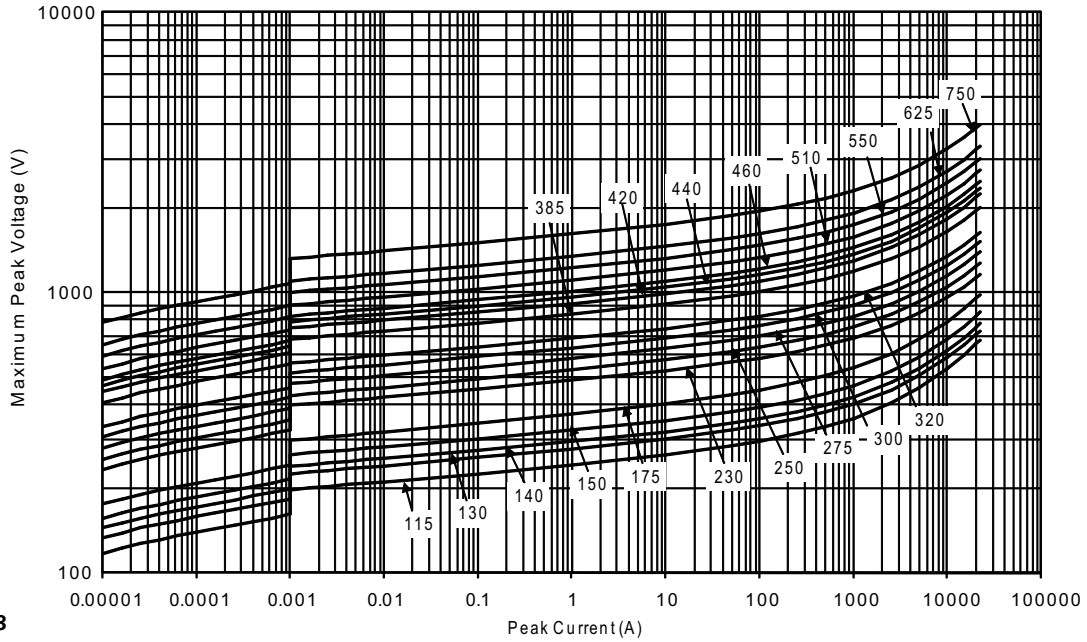

Figure 3

Pulse Rating Curve

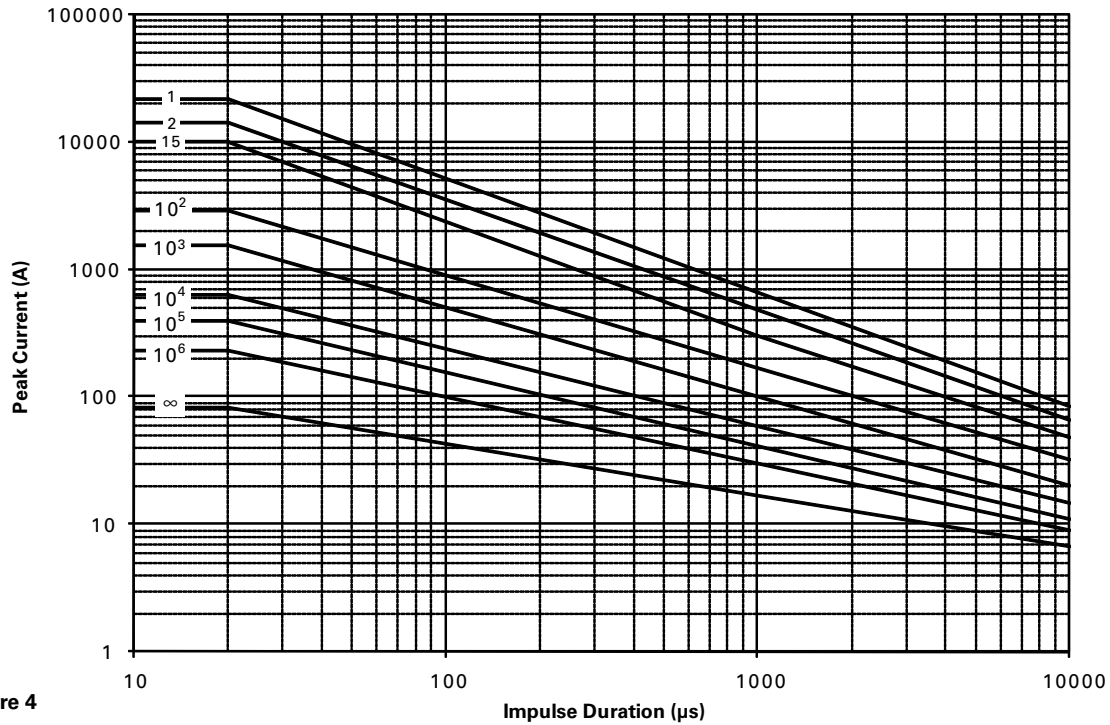
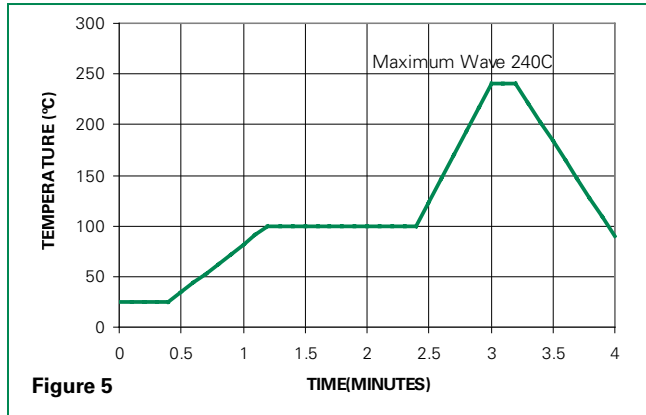

Figure 4

Wave Solder Profile

Non Lead-free Wave Solder Profile



Lead-free Wave Solder Profile

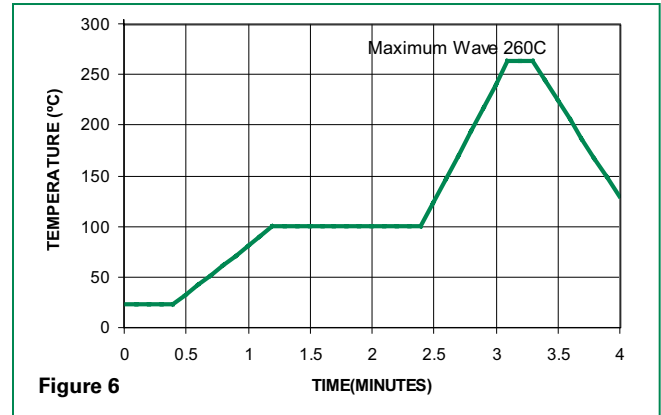

Physical Specifications

Lead Material	Copper Clad Steel Wire
Soldering Characteristics	Solderability per MIL-STD-202, Method 208
Insulating Material	Cured, flame retardant epoxy polymer meets UL94V-0 requirements
Device Labeling	Marked with LF, voltage, UL/CSA Logos, and date code

Environmental Specifications

Operating Temperature	-55°C to +85°C
Storage Temperature	-55°C to +125°C
Humidity Aging	+85°C, 85% RH, 1000 hours +/-10% typical voltage change
Thermal Shock	+85°C to -40°C 5 times +/-10% typical voltage change
Solvent Resistance	MIL-STD-202, Method 215
Moisture Sensitivity	Level 1, J-STD-020

UltraMOV® 25S Varistor Series for High-Temperature Operating Conditions:

Phenolic coated devices are available with improved maximum operating temperature 125°C. These devices also have improved temperature cycling capability. Ratings and specifications are per standard series except Hi-Pot Encapsulation (Isolation Voltage Capability) = 500V.

To order: add 'X1347' to part number (e.g. V25S150PX1347). These devices are NOT UL, CSA, CECC or VDE certified. Contact factory for further details.

Product Dimensions (mm)

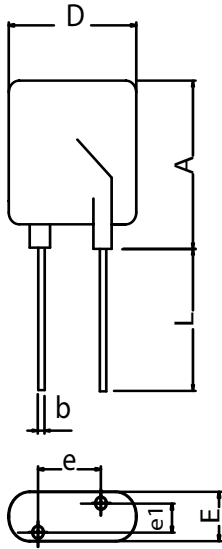

	A max	b min	b max	D max	e min	e max	e1 min	e1 max	E max	L min
V25S115P							1.5	2.7	5.7	25.4
V25S130P							1.6	2.9	5.9	
V25S140P							1.7	3.0	6.0	
V25S150P							1.8	3.1	6.1	
V25S175P							1.9	3.3	6.3	
V25S230P							2.0	3.4	6.4	
V25S250P							2.1	3.5	6.5	
V25S275P							2.3	3.7	6.7	
V25S300P							2.4	3.9	6.9	
V25S320P	32.5	0.95	1.05	28	11.7	13.7	2.6	4.1	7.1	
V25S385P							3.0	4.7	7.7	
V25S420P							3.3	5.0	8.0	
V25S440P							3.4	5.2	8.2	
V25S460P							3.6	5.4	8.4	
V25S510P							1.6	3.4	8.7	
V25S550P							1.9	3.9	9.2	
V25S625P							2.3	4.3	9.6	
V25S750P							3.1	5.4	10.7	

Notes

1. Additional optional lead form, packaging and lead spacing requirements are subject to availability and to minimum order requirements. Please contact factory for details.
2. Nickel Barrier Wire option (Suffix 'X2855') Standard parts use Tin-Coated Copper wire. Nickel Barrier Coated Wire is available as an option. This is Copper Wire with a flashing of Nickel, followed by a top coat of Tin. To order please add suffix 'X2855' to end of standard part number. Contact factory for more details if required.

Disclaimer Notice - Information furnished is believed to be accurate and reliable. However, users should independently evaluate the suitability of and test each product selected for their own applications. Littelfuse products are not designed for, and may not be used in, all applications. Read complete Disclaimer Notice at www.littelfuse.com/disclaimer-electronics.

C-III Varistor Series

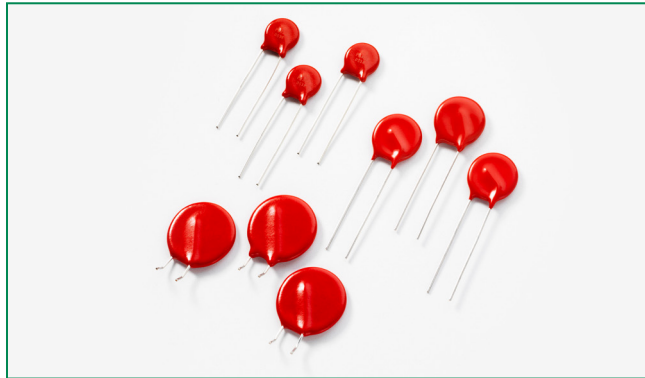

Description

The C-III Varistor Series of Metal-Oxide Varistors (MOVs) are specifically designed for applications requiring high surge energy absorption ratings and superior multiple pulse absorption rating. This is achieved through a special dielectric material formulation which also results in higher repetitive surge ratings than other MOV types.

The C-III Varistor Series is primarily intended for use in AC line Surge Protection Device (SPD) product and other similar applications requiring high transient energy and peak current capability in a relatively small package size.

Agency Approvals

Agency	Agency Approval	Agency File Number
	UL1449	E320116
	CECC 42201-006 IEC 61051-1 IEC 61051-2 IEC 60950-1 (Annex Q) for 14mm and 20mm only	116895
	C22.2 No. 8	91788
	CECC 42201-006 IEC 61051-1 IEC 61051-2 IEC 60950-1 (Annex Q) for 14mm and 20mm only	E1273/F

Features

- Lead-free, Halogen-Free and RoHS compliant
- High energy absorption capability W_{TM} 40J to 530J (2ms)
- High pulse life rating
- High peak pulse current capability I_{TM} 3500A to 10,000A (8/20 μ s)
- Wide operating voltage range $V_{MI(AC)RMS}$ 130V to 1000V
- Available in tape and reel for automatic insertion; Also available with crimped and/or trimmed lead styles
- No derating up to 85°C ambient
- The C-III Series is supplied in 10mm, 14mm and 20mm disc versions with various lead options

Additional Information



Datasheet



Resources



Samples

Absolute Maximum Ratings

- For ratings of individual members of a series, see Device Ratings and Specifications chart

Continuous	C-III Series	Units
Steady State Applied Voltage:		
AC Voltage Range ($V_{MI(AC)RMS}$)	130 to 1000	V
Transients:		
Single-Pulse Peak Current (I_{TM}) 8/20 μ s Wave (See Peak Pulse Current Test Waveform)	3500 to 10,000	A
Single-Pulse Energy Range (W_{TM}) 2ms Rectangular Wave	40 to 530	J
Operating Ambient Temperature Range (T_A)	-55 to +85	°C
Storage Temperature Range (T_{STG})	-55 to +125	°C
Temperature Coefficient (α^V) of Clamping Voltage (V_C) at Specified Test Current	<0.01	%/°C
Hi-Pot Encapsulation (COATING Isolation Voltage Capability)	2500	V
COATING Insulation Resistance	1000	M Ω

CAUTION: Stresses above those listed in "Absolute Maximum Ratings" may cause permanent damage to the device. This is a stress only rating and operation of the device at these or any other conditions above those indicated in the operational sections of this specification is not implied.

C-III Series Ratings

Part Number	Branding	Disc Size (mm)	Maximum Ratings (85 °C)				Specifications (25 °C)					
			Continuous	Transient			Varistor Voltage at 1mA DC Test Current		Maximum Clamping Voltage (8/20µs)		Duty Cycle Surge Rating	
			Maximum V_{RMS} $V_{M(AC)}$ (V)	Withstanding Energy (2ms) W_{TM} (J)	Peak Current (8/20µs)							
					I_{TM1} 1 Pulse (A)	I_{TM2} 2 Pulses (A)	V_N Min (V)	V_N Max (V)	V_C (V)	I_D (A)	3kA (8/20µs) # Pulses	750A (8/20µs) # Pulses
V130LA5CP	P130L5C	10	130	40	3500	3000	184.5	225.5	340	25	2	20
V130LA10CP	P130L10C	14	130	80	6500	5000	184.5	225.5	340	50	10	80
V130LA20CP	P130L20C	20	130	200	10000	7000	184.5	225.5	340	100	20	120
V130LA20CPX325	P130X325	20	130	200	10000	7000	190	220	325	100	20	120
V140LA5CP	P140L5C	10	140	45	3500	3000	198	242	360	25	2	20
V140LA10CP	P140L10C	14	140	90	6500	5000	198	242	360	50	10	80
V140LA20CP	P140L20C	20	140	210	10000	7000	198	242	360	100	20	120
V140LA20CPX340	P140X340	20	140	210	10000	7000	198	230	340	100	20	120
V150LA5CP	P150L5C	10	150	50	3500	3000	216.0	264.0	395	25	2	20
V150LA10CP	P150L10C	14	150	100	6500	5000	216.0	264.0	395	50	10	80
V150LA20CP	P150L20C	20	150	215	10000	7000	216.0	264.0	395	100	20	120
V150LA20CPX360	P150X360	20	150	215	10000	7000	216	243	360	100	20	120
V175LA5CP	P175L5C	10	175	55	3500	3000	243	297	455	25	2	20
V175LA10CP	P175L10C	14	175	110	6500	5000	243	297	455	50	10	80
V175LA20CP	P175L20C	20	175	220	10000	7000	243	297	455	100	20	120
V175LA20CPX425	P175X425	20	175	220	10000	7000	247	285	425	100	20	120
V230LA10CP	P230L10C	10	230	60	3500	3000	324	396	595	25	2	20
V230LA20CP	P230L20C	14	230	125	6500	5000	324	396	595	50	10	80
V230LA40CP	P230L40C	20	230	280	10000	7000	324	396	595	100	20	120
V230LA40CPX570	P230X570	20	230	280	10000	7000	324	384	570	100	20	120
V250LA10CP	P250L10C	10	250	65	3500	3000	351	429	650	25	2	20
V250LA20CP	P250L20C	14	250	135	6500	5000	351	429	650	50	10	80
V250LA40CP	P250L40C	20	250	300	10000	7000	351	429	650	100	20	120
V250LA40CPX620	P250X620	20	250	300	10000	7000	354	413	620	100	20	120
V275LA10CP	P275L10C	10	275	70	3500	3000	387	473	710	25	2	20
V275LA20CP	P275L20C	14	275	145	6500	5000	387	473	710	50	10	80
V275LA40CP	P275L40C	20	275	320	10000	7000	387	473	710	100	20	120
V275LA40CPX680	P275X680	20	275	320	10000	7000	389	453	680	100	20	120
V300LA10CP	P300L10C	10	300	75	3500	3000	423.0	517.0	775	25	2	20
V300LA20CP	P300L20C	14	300	155	6500	5000	423.0	517.0	775	50	10	80
V300LA40CP	P300L40C	20	300	335	10000	7000	423.0	517.0	775	100	20	120
V300LA40CPX745	P300X745	20	300	335	10000	7000	420	490	745	100	20	120
V320LA10CP	P320L10C	10	320	80	3500	3000	462.0	558.0	850	25	2	20
V320LA20CP	P320L20C	14	320	165	6500	5000	462.0	558.0	850	50	10	80
V320LA40CP	P320L40C	20	320	345	10000	7000	462.0	558.0	850	100	20	120
V320LA40CPX810	P320X810	20	320	345	10000	7000	462	540	810	100	20	120
V385LA10CP	P385L10C	10	385	85	3500	3000	558	682	1025	25	2	20
V385LA20CP	P385L20C	14	385	175	6500	5000	558	682	1025	50	10	80
V385LA40CP	P385L40C	20	385	370	10000	7000	558	682	1025	100	20	120
V420LA10CP	P420L10C	10	420	90	3500	3000	612.0	748.0	1120	25	2	20
V420LA20CP	P420L20C	14	420	185	6500	5000	612.0	748.0	1120	50	10	80
V420LA40CP	P420L40C	20	420	390	10000	7000	612.0	748.0	1120	100	20	120
V460LA10CP	P460L10C	10	460	95	3500	3000	643.5	786.5	1190	25	2	20
V460LA20CP	P460L20C	14	460	190	6500	5000	643.5	786.5	1190	50	10	80

C-III Series Specifications (continued from previous page)

Part Number	Branding	Disc Size (mm)	Maximum Ratings (85 °C)				Specifications (25 °C)					
			Continuous		Transient		Varistor Voltage at 1mA DC Test Current		Maximum Clamping Voltage (8/20µs)		Duty Cycle Surge Rating	
			Maximum V_{RMS} $V_{M(AC)}$ (V)	Withstanding Energy (2ms) W_{TM} (J)	Peak Current (8/20µs)							
					1 Pulse I_{TM1} (A)	2 Pulses I_{TM2} (A)	V_N Min (V)	V_N Max (V)	V_C (V)	I_D (A)	3kA (8/20µs) # Pulses	750A (8/20µs) # Pulses
V460LA40CP	P460L40C	20	460	430	10000	7000	643.5	786.5	1190	100	20	120
V480LA10CP	P480L10C	10	480	95	3500	3000	675.0	825.0	1240	25	2	20
V480LA40CP	P480L40C	14	480	195	6500	5000	675.0	825.0	1240	50	10	80
V480LA80CP	P480L80C	20	480	420	10000	7000	675.0	825.0	1240	100	20	120
V510LA10CP	P510L10C	10	510	98	3500	3000	738.0	902.0	1350	25	2	20
V510LA40CP	P510L40C	14	510	205	6500	5000	738.0	902.0	1350	50	10	80
V510LA80CP	P510L80C	20	510	440	10000	7000	738.0	902.0	1350	100	20	120
V550LA10CP	P550L10C	10	550	98	3500	3000	792.0	968.0	1435	25	2	20
V550LA40CP	P550L40C	14	550	210	6500	5000	792.0	968.0	1435	50	10	80
V550LA80CP	P550L80C	20	550	450	10000	7000	792.0	968.0	1435	100	20	120
V575LA10CP	P575L10C	10	575	100	3500	3000	819.0	1001.0	1500	25	2	20
V575LA40CP	P575L40C	14	575	230	6500	5000	819.0	1001.0	1500	50	10	80
V575LA80CP	P575L80C	20	575	460	10000	7000	819.0	1001.0	1500	100	20	120
V625LA10CP	P625L10C	10	625	105	3500	3000	900	1100	1650	25	2	20
V625LA40CP	P625L40C	14	625	235	6500	5000	900	1100	1650	50	10	80
V625LA80CP	P625L80C	20	625	490	10000	7000	900	1100	1725	100	20	120
V660LA10CP	P660L10C	10	660	110	3500	3000	972.0	1188.0	1820	25	2	20
V660LA50CP	P660L50C	14	660	240	6500	5000	972.0	1188.0	1820	50	10	80
V660LA80CP	P660L80C	20	660	510	10000	7000	972.0	1188.0	1820	100	20	120
V680LA10CP	P680L10C	10	680	115	3500	3000	990.0	1210.0	1860	25	2	20
V680LA80CP	P680L80C	14	680	240	6500	5000	990	1210	1820	50	10	80
V680LA100CP	P680L100C	20	680	520	10000	7000	990	1130	1700	100	20	120
V1000LA80CP	P1000L8C	14	1000	260	6500	5000	1500	1800	2700	50	10	80
V1000LA160CP	P1000L16C	20	1000	530	10000	7000	1500	1800	2700	100	20	120

NOTES:

- Average power dissipation of transients not to exceed 0.6W and 1W for model sizes 14mm and 20mm, respectively.
- 7mm parts also available-contact factory for further information
- For additional or intermediary voltage ratings contact factory

Phenolic Coating Option -- C-III Series Varistors for Hi-Temperature Operating Conditions:

- Phenolic Coated CIII Series devices are available with improved maximum operating maximum temperature 125°C
- These devices also have improved temperature cycling performance capability.
- Ratings and Specifications are as per standard except Hi-Pot Encapsulation (Isolation Voltage Capability)=500V.
- To order: add X1347 to part number (e.g. V230LA40CPX1347)
- These devices are not UL, CSA, VDE or CECC certified.
- Contact factory for further details.
- Product marking:

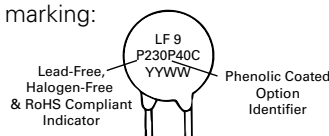

Current Energy and Power Dissipation Ratings

Should transients occur in rapid succession, the average power dissipation is the energy (watt-seconds) per pulse times the number of pulses per second. The power so developed must be within the specifications shown on the Device Ratings and Specifications Table for the specific

device. The operating values of a MOV need to be derated at high temperatures as shown above. Because varistors only dissipate a relatively small amount of average power they are not suitable for repetitive applications that involve substantial amounts of average power dissipation.

Figure 1A - Power Derating for Epoxy Coated

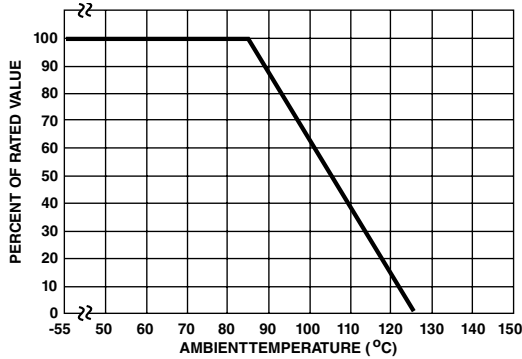
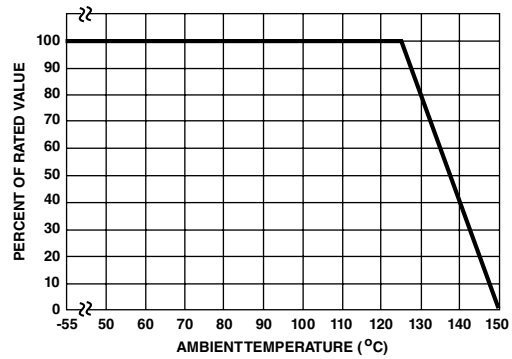
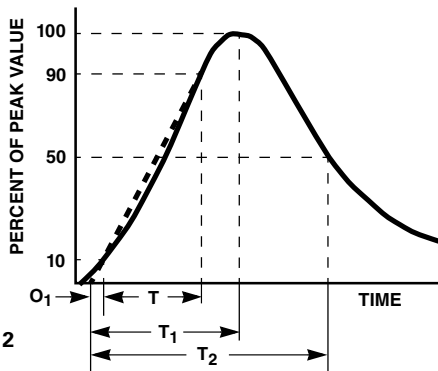

Figure 1B - Power Derating for Phenolic Coated



Peak Pulse Current Test Waveform



O_1 = Virtual Origin of Wave
T = Time from 10% to 90% of Peak
 T_1 = Rise Time = $1.25 \times T$
 T_2 = Decay Time

Example - For an $8/20 \mu s$ Current Waveform:
 $8 \mu s = T_1 =$ Rise Time
 $20 \mu s = T_2 =$ Decay Time

Figure 2

Transient V-I Characteristics Curves

Maximum Clamping Voltage for 10mm Parts

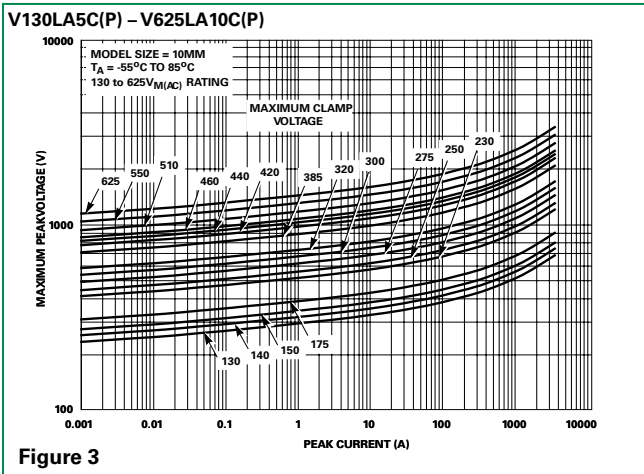

Figure 3

Pulse Rating Curves

Repetitive Surge Capability for 10mm Parts

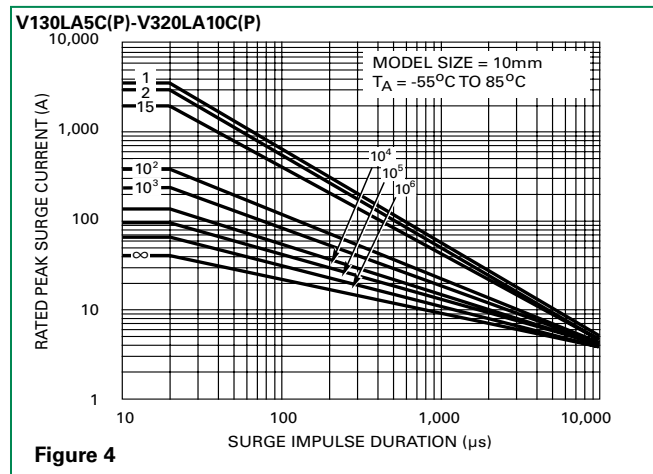
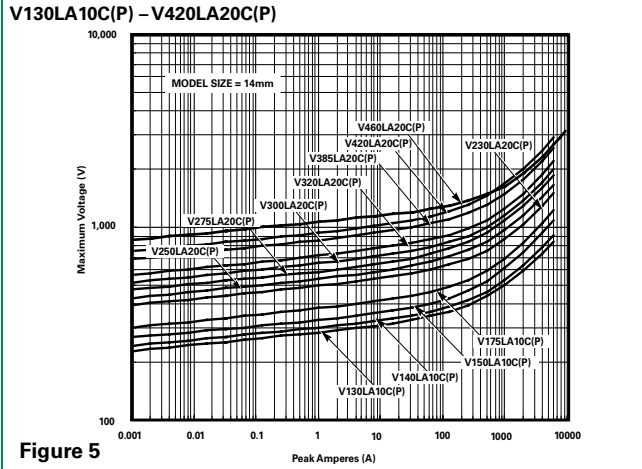

Figure 4

Transient V-I Characteristics Curves

Maximum Clamping Voltage for 14mm Parts



Pulse Rating Curves

Repetitive Surge Capability for 14mm Parts

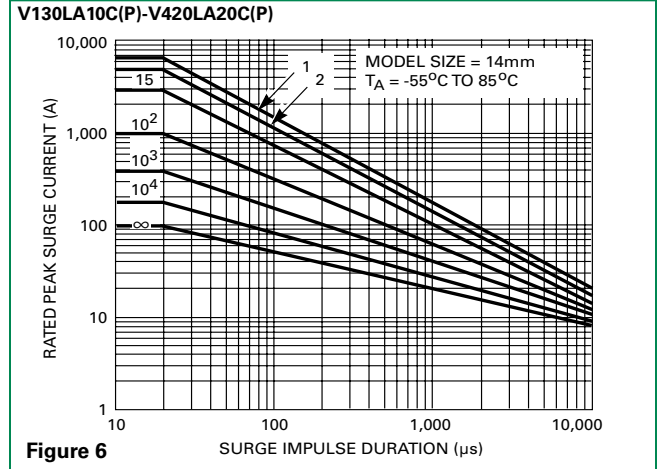

Maximum Clamping Voltage for 20mm Parts

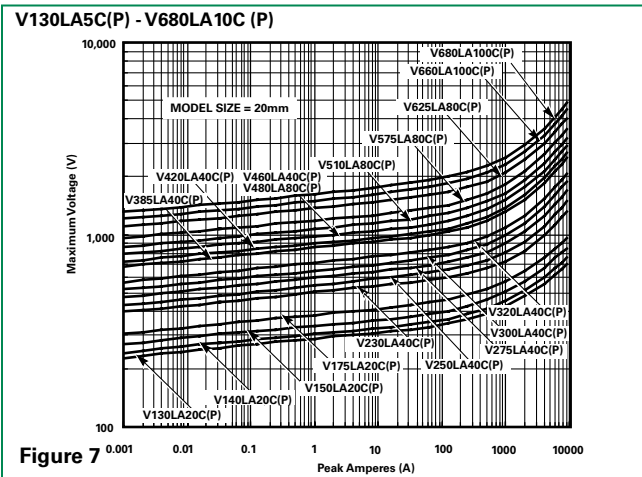

Repetitive Surge Capability for 20mm Parts

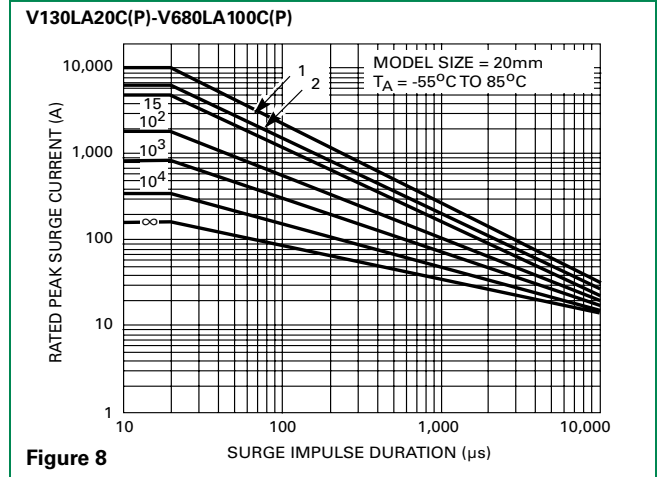

Maximum Clamping Voltage for Low Clamping Voltage Parts

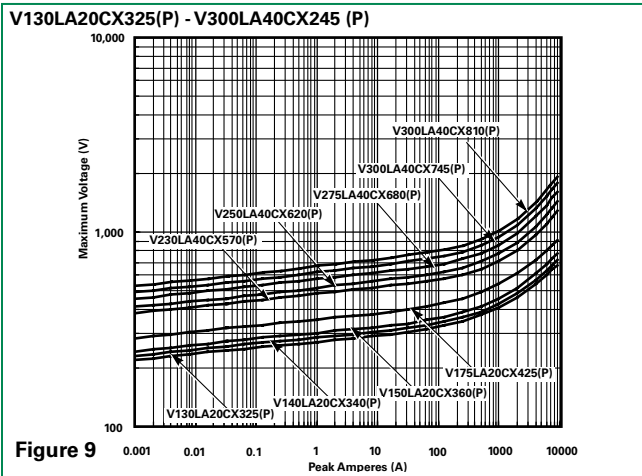

Wave Solder Profile

Non Lead-free Profile

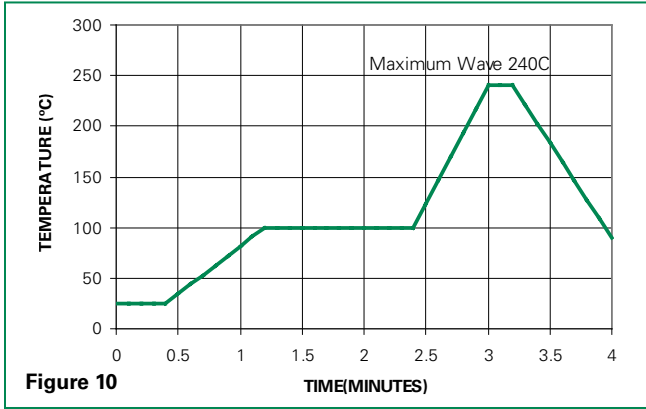

Lead-free Profile

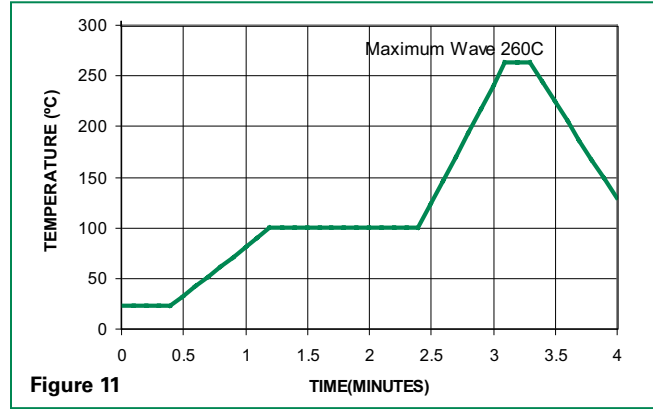

Physical Specifications

Lead Material	Copper Clad Steel Wire
Soldering Characteristics	Solderability per MIL-STD-202, Method 208
Insulating Material	Cured, flame retardant epoxy polymer meets UL94V-0 requirements
Device Labeling	Marked with LF, voltage, UL/CSA Logos, and date code

Environmental Specifications

Operating/Storage Temperature	-55°C to +85°C/-55°C to +125°C
Humidity Aging	+85°C, 85% RH, 1000 hours +/-10% typical voltage change
Thermal Shock	+85°C to -40°C, 5 times +/-10% typical voltage change
Solvent Resistance	MIL-STD-202, Method 215
Moisture Sensitivity	Level 1, J-STD-020

AC Bias Reliability

The C-III Series MOVs were designed for use on the AC line. The varistor is connected across the AC line and is biased with a constant amplitude sinusoidal voltage. It should be noted that the definition of failure is a shift in the nominal varistor voltage (V_N) exceeding +/-10%. Although this type of varistor is still functioning normally after this magnitude of shift, devices at the lower extremities of V_N tolerance will begin to dissipate more power.

Because of this possibility, an extensive series of statistically designed tests were performed to determine the reliability of the C-III type of varistor under AC bias combined with high levels of temperature stress. To date, this test has generated over 50,000 device hours of operation at a temperature of 125°C, although only rated at 85°C. Changes in the nominal varistor voltage, measured at 1mA, of less than 2% have been recorded, as displayed in the diagram at right.

High Temperature Operating Life 125°C for 1000 Hours at Rated Bias

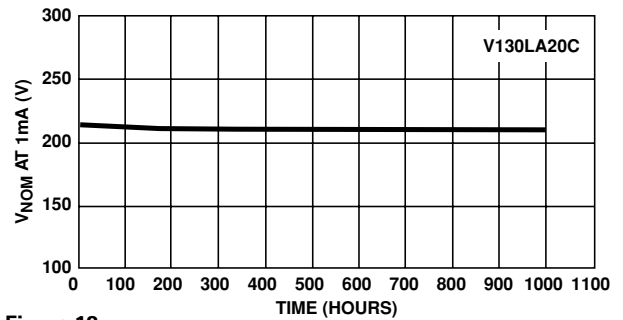

Figure 12

Transient Surge Current/Energy Transient Capability

The transient surge rating serves as an excellent figure of merit for the C-III varistor. This inherent surge handling capability is one of the C-III varistor's best features. The enhanced surge absorption capability results from improved process uniformity and enhanced construction. The homogeneity of the raw material powder and improved control over the sintering and assembly processes are contributing factors to this improvement.

In the low power AC mains environment, industry standards (UL, IEC, NEMA and IEEE) all suggest that the worst case surge occurrence will be 3kA. Such a transient event may occur up to five times over the equipment life time (approximately 10 years). While the occurrences of five 3kA transients is the required capability, the rated, repetitive surge current for the C-III Series is 20 pulses for the 20mm units and 10 pulses for the 14mm Series.

As a measure of the inherent device capability, samples of the 20mm V130LA20C devices were subjected to a worst case repetitive transient surges test. After 20 pulses, each of 3kA, there was negligible change in the device characteristics. Changes in the clamping voltage, measured at 100A, of less than 3% were recorded, as shown in the upper diagram at right.

Samples of the 20mm Series V175LA20C were subjected to repetitive surge occurrences of 750A. Again, there was negligible changes in any of the device characteristics after 120 pulses, as shown in the lower diagram at right.

In both cases the inherent device capability is far in excess of the expected worst case scenario.

Typical Repetitive Surge Current Capability of C-III Series MOVs

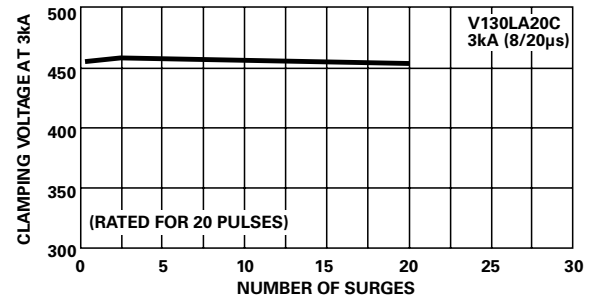

Figure 13

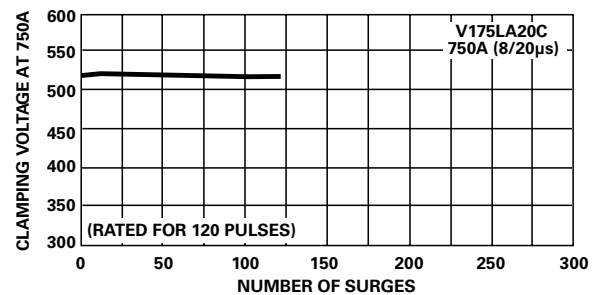
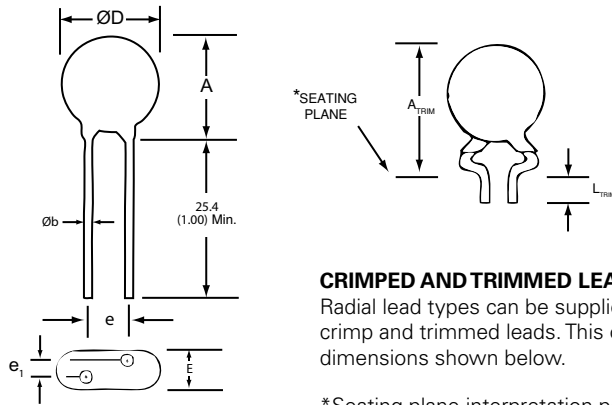

Figure 14

Product Dimensions (mm)



CRIMPED AND TRIMMED LEADS

Radial lead types can be supplied with combination preformed crimp and trimmed leads. This option is supplied to the dimensions shown below.

*Seating plane interpretation per IEC-60717

Dimension	V _{RMS} Voltage Model	10mm Size		14mm Size		20mm Size	
		Min.	Max.	Min.	Max.	Min.	Max.
A	All	12.0 (0.472)	16.0 (0.630)	13.5 (0.531)	20.0 (0.787)	17.5 (0.689)	28.0 (1.102)
ØD	All	10.0 (0.394)	12.5 (0.492)	13.5 (0.531)	17.0 (0.669)	17.5 (0.689)	23.0 (0.906)
e	All	6.5 (0.256)	8.5 (0.335)	6.5 (0.256)	8.5 (0.335)	6.5 (0.256)	8.5 (0.335)
e₁	130 - 320	1.5 (0.059)	5.5 (0.216)	1.5 (0.059)	4.5 (0.177)	1.5 (0.059)	4.5 (0.177)
	385 - 680	2.5 (0.098)	7.5 (0.295)	2.5 (0.098)	7.5 (0.295)	2.5 (0.098)	7.5 (0.295)
	> 680	4.5 (0.177)	9.5 (0.374)	4.5 (0.177)	9.5 (0.374)	4.5 (0.177)	9.5 (0.374)
E	130 - 320	-	7.3 (0.287)	-	7.3 (0.287)	-	7.3 (0.287)
	385 - 680		11.0 (0.433)		11.0 (0.433)		11.0 (0.433)
	> 680		14.0 (0.551)		14.0 (0.551)		14.0 (0.551)
øb	130 - 625	0.76 (0.030)	0.86 (0.034)	0.76 (0.030)	0.86 (0.034)	0.76 (0.030)	0.86 (0.034)
	>625					0.95 (0.037)	1.05 (0.041)
A_{TRIM}	All	-	19.5 (0.768)	-	23.5 (0.925)	-	30.0 (1.18)
L_{TRIM}	All	2.41 (0.095)	4.69 (0.185)	2.41 (0.095)	4.69 (0.185)	2.41 (0.095)	4.69 (0.185)

Dimensions are in millimeters (inches)

- 10mm lead spacing also available. See additional lead style options.
- 7mm and 12mm devices also available upon request. Contact factory for details.

Disclaimer Notice - Information furnished is believed to be accurate and reliable. However, users should independently evaluate the suitability of and test each product selected for their own applications. Littelfuse products are not designed for, and may not be used in, all applications. Read complete Disclaimer Notice at www.littelfuse.com/disclaimer-electronics.

Tape and Reel Specifications

- (available for voltage ratings up to 550V only)

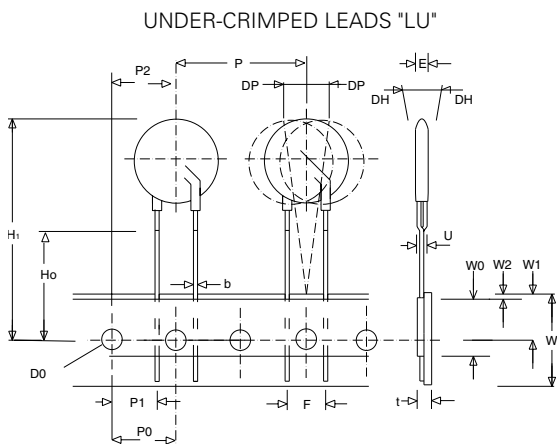
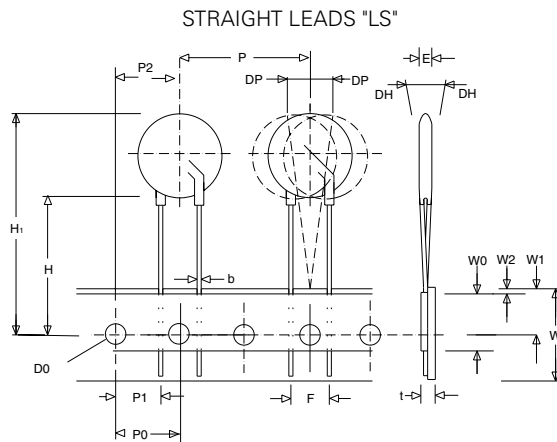
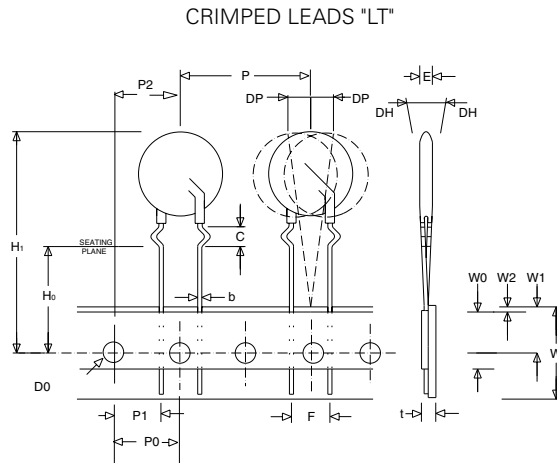

Symbol	Description	Model Size		
		10mm	14mm	20mm
P	Pitch of Component	25.4 +/-1.0		
P₀	Feed Hole Pitch	12.7 +/- 0.2		
P₁	Feed Hole Center to Pitch	8.85 +/- 0.8		
P₂	Hole Center to Component Center	12.7 +/- 0.7		
F	Lead to Lead Distance	7.50 +/- 0.8		
h	Component Alignment	2.00 Max		
W	Tape Width	18.25 +/- 0.75		
W₀	Hold Down Tape Width	12.0 +/- 0.3		
W₁	Hole Position	9.125 +/- 0.625		
W₂	Hold Down Tape Position	0.5 Max		
H	Height From Tape Center To Component Base	19.0 +/-1.0		
H₀	Seating Plane Height	16.0 +/- 0.5		
H₁	Component Height	36 Max	40 Max	46.5 Max
D₀	Feed Hole Diameter	4.0 +/- 0.2		
t	Total Tape Thickness	0.7 +/- 0.2		
p	Component Alignment	3° Max		
U	Under crimp Width	8.0 Max		

Part Numbering System

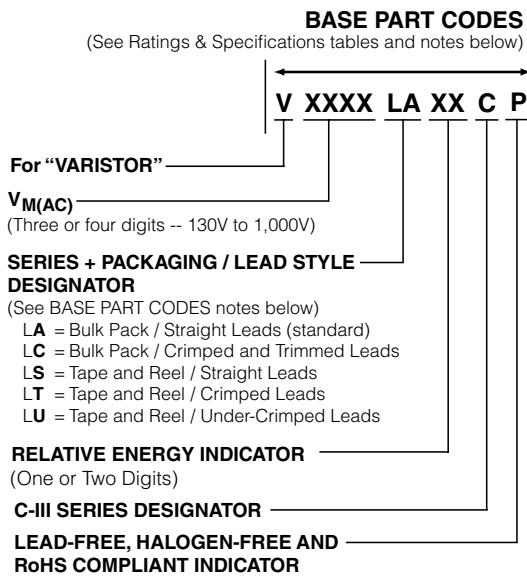

See OPTIONS CODES notes below

For standard parts, use the **BASE PART** designator only.
For parts with non-standard options (such as additional form, packaging and lead space options), use **BASE PART + OPTION CODE**.
OPTION CODE items are subject to availability and minimum order requirements. Please contact a Littelfuse products representative for additional information or questions

Ordering Notes:

BASE PART CODES:

Series + Packaging / Lead Style Designators:

Ordering examples:

Straight Lead Bulk Pack (standard)	Straight Lead Tape & Reel	Crimped & Trimmed Lead Bulk Pack	Under-Crimp Lead Tape & Reel
V130 LA 20CP	V130 LS 20CP	V130 LC 20CP	V130 LU 20CP

Crimped leads are standard on LA Series varistors supplied in tape and reel, denoted with "LT."

"LC" style is supplied in bulk only.

"LU" style is supplied in tape & reel only.

For crimped leads without trimming and any variations other than that described above, please contact Littelfuse.

Packaging and Quantities:

Littelfuse C-III Series varistors are shipped standard in bulk pack with straight leads and lead spacing outlined in the Package Dimensions section of this data sheet.

Tape & Reel Quantities:

Device Size	Voltage	Quantity Per Reel		
		"T" Reel	"S" Reel	"U" Reel
10mm	ALL	500	500	500
	≤ 275V	500	500	500
14mm	≥ 275V	400	400	400
	≤ 275V	500	500	500
20mm	≥ 275V	400	400	400

OPTION CODES:

X10: 10MM LEAD SPACING OPTION –

For 10 (-/+1)mm lead spacing (available on 20mm diameter models only), append standard model BASE PART number with "X10." Example:

Standard Model	Order As
V130LA20CP	V130LA20CP X10

X2855: Nickel Barrier COATED WIRE OPTION –

All standard parts use tinned copper clad steel wire. Nickel Barrier Coated wire is available as an option, consisting of Copper wire with a flashing of Nickel followed by a top coating of Tin. To order append standard model BASE PART number with "X2855." Example:

Standard Model	Order As
V130LA20CP	V130LA20CP X2855

X1347: Hi-Temperature phenolic coating option –

Phenolic Coated C-III Series devices are available with improved maximum operating maximum temperature of 125°C.

To order, add X1347 to end of part number (Example: V230LA40CPX1347).

For additional information please refer to the section labeled "Phenolic Coating Option" on the third page of this document under the "Electrical Characteristics" table.

LA Varistor Series

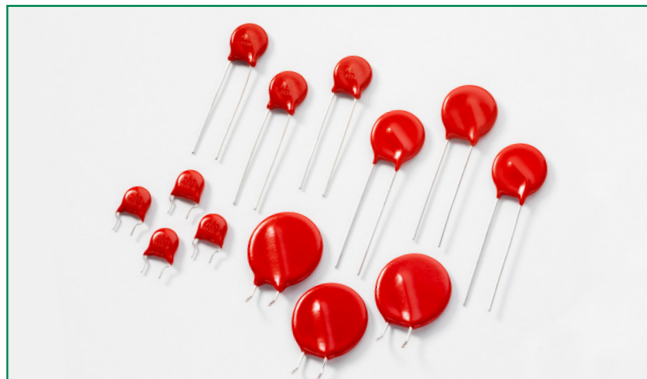

Agency Approvals

Agency	Agency Approval	Agency File Number
	UL1449	E320116
	CECC 42201-006 IEC 61051-1 IEC 61051-2 IEC 60950-1 (Annex Q) for 14mm and 20mm only	116895
	22.2-1	91788
	CECC 42201-006 IEC 61051-1 IEC 61051-2 IEC 60950-1 (Annex Q) for 14mm and 20mm only	E1273/F

Description

The LA Varistor Series of transient voltage surge suppressors are radial leaded varistors (MOVs) that are designed to be operated continuously across AC power lines. These UL recognized varistors require very little mounting space, and are offered in various standard lead form options.

The LA Varistor Series are available in four model sizes: 7mm, 10mm, 14mm and 20mm; and have a $V_{M(AC)RMS}$ voltage range from 130V to 1000V, and an energy absorption capability up to 360J. Some LA Series model numbers are available with clamping voltage selections, designated by a model number suffix of either A or B. The 'A' selection is the standard model; the 'B' selection provides a lower clamping voltage. See LA Series Device Ratings and Specifications Table for part number and brand information.

Features

- Lead-free, Halogen-Free and RoHS compliant.
- Energy absorption capability (W_{TM}) up to 360J
- Wide operating voltage range $V_{M(AC)RMS}$ 130V to 1000V
- No derating up to 85°C ambient
- Available in tape and reel or bulk pack

Additional Information



Datasheet



Resources



Samples

Absolute Maximum Ratings

• For ratings of individual members of a series, see Device Ratings and Specifications chart

Continuous	LA Series	Units
Steady State Applied Voltage:		
AC Voltage Range ($V_{M(AC)RMS}$)	130 to 1000	V
DC Voltage Range ($V_{M(DC)}$)	175 to 1200	V
Transients:		
Peak Pulse Current (I_{TM})		
For 8/20 μ s Current Wave (See Figure 2)	1200 to 6500	A
Single Pulse Energy Range		
For 10/1000 μ s Current Wave (W_{TM})	11 to 360	J
Operating Ambient Temperature Range (T_A)	-55 to +85	°C
Storage Temperature Range (T_{STG})	-55 to +125	°C
Temperature Coefficient (α) of Clamping Voltage (V_C) at Specified Test Current	<0.01	%/°C
Hi-Pot Encapsulation (COATING Isolation Voltage Capability) (Dielectric must withstand indicated DC voltage for one minute per MIL-STD 202, Method 301)	2500	V
COATING Insulation Resistance	1000	M Ω

CAUTION: Stresses above those listed in "Absolute Maximum Ratings" may cause permanent damage to the device. This is a stress only rating and operation of the device at these or any other conditions above those indicated in the operational sections of this specification is not implied.

LA Series Ratings & Specifications

Part Number	Branding	Model Size Disc Dia. (mm)	Maximum Rating (85°C)				Specifications (25°C)				
			Continuous		Transient		Varistor Voltage at 1mA DC Test Current		Maximum Clamping Voltage 8 x 20 μs		Typical Capaci- tance f = 1MHz
			V _{RMS}	V _{DC}	Energy 10 x 1000 μs	Peak Current 8 x 20 μs					
			V _{M(AC)}	V _{M(DC)}	W _{TM}	I _{TM}	V _{NOM} Min	V _{NOM} Max	V _C	I _{PK}	C
(V)	(V)	(J)	(A)	(V)	(V)	(V)	(A)	(pF)			
V130LA1P	P1301	7	130	175	11	1200	198	242	390	10	180
V130LA2P	P1302	7	130	175	11	1200	184.5	225.5	340	10	180
V130LA5P	P1305	10	130	175	20	2500	184.5	225.5	340	25	450
V130LA10AP	P130L10	14	130	175	38	4500	184.5	225.5	340	50	1000
V130LA20AP	P130L20	20	130	175	70	6500	184.5	225.5	340	100	1900
V130LA20BP	P130L20B	20	130	175	70	6500	190	220	325	100	1900
V140LA2P	P1402	7	140	180	12	1200	198	242	360	10	160
V140LA5P	P1405	10	140	180	22	2500	198	242	360	25	400
V140LA10AP	P140L10	14	140	180	42	4500	198	242	360	50	900
V140LA20AP	P140L20	20	140	180	75	6500	198	242	340	100	1750
V150LA1P	P1501	7	150	200	13	1200	225	275	430	10	150
V150LA2P	P1502	7	150	200	13	1200	216	264	395	10	150
V150LA5P	P1505	10	150	200	25	2500	216	264	395	25	360
V150LA10AP	P150L10	14	150	200	45	4500	216	264	395	50	800
V150LA20AP	P150L20	20	150	200	80	6500	216	264	395	100	1600
V150LA20BP	P150L20B	20	150	200	80	6500	216	243	360	100	1600
V175LA2P	P1752	7	175	225	15	1200	243	297	455	10	130
V175LA5P	P1755	10	175	225	30	2500	243	297	455	25	350
V175LA10AP	P175L10	14	175	225	55	4500	243	297	455	50	700
V175LA20AP	P175L20	20	175	225	90	6500	243	297	455	100	1400
V230LA4P	P2304	7	230	300	20	1200	324	396	595	10	100
V230LA10P	P230L	10	230	300	35	2500	324	396	595	25	250
V230LA20AP	P230L20	14	230	300	70	4500	324	396	595	50	550
V230LA40AP	P230L40	20	230	300	122	6500	324	396	595	100	1100
V250LA2P	P2502	7	250	330	21	1200	369	451	730	10	90
V250LA4P	P2504	7	250	330	21	1200	351	429	650	10	90
V250LA10P	P250L	10	250	330	40	2500	351	429	650	25	220
V250LA20AP	P250L20	14	250	330	72	4500	351	429	650	50	500
V250LA40AP	P250L40	20	250	330	130	6500	351	429	650	100	1000
V250LA40BP	P250L40B	20	250	330	130	6500	354	413	620	100	1000
V275LA2P	P2752	7	275	369	23	1200	405	495	775	10	80
V275LA4P	P2754	7	275	369	23	1200	387	473	710	10	80
V275LA10P	P275L	10	275	369	45	2500	387	473	710	25	200
V275LA20AP	P275L20	14	275	369	75	4500	387	473	710	50	450
V275LA40AP	P275L40	20	275	369	140	6500	387	473	710	100	900
V275LA40BP	P275L40B	20	275	369	140	6500	389	453	680	100	900
V300LA2P	P3002	7	300	405	25	1200	441	539	870	10	70
V300LA4P	P3004	7	300	405	25	1200	423	517	775	10	70
V300LA10P	P300L	10	300	405	46	2500	423	517	775	25	180
V300LA20AP	P300L20	14	300	405	77	4500	423	517	775	50	400
V300LA40AP	P300L40	20	300	405	165	6500	423	517	775	100	800
V320LA7P	P3207	7	320	420	25	1200	459	561	850	10	65
V320LA10P	P320L	10	320	420	48	2500	459	561	850	25	170
V320LA20AP	P320L20	14	320	420	80	4500	459	561	850	50	380
V320LA40BP	P320L40	20	320	420	150	6500	462	540	810	100	750
V385LA7P	P3857	7	385	505	27	1200	558	682	1025	10	60

LA Series Ratings & Specifications (Continued...)

Part Number	Branding	Model Size Disc Dia. (mm)	Maximum Rating (85°C)				Specifications (25°C)				
			Continuous		Transient		Varistor Voltage at 1mA DC Test Current	Maximum Clamping Voltage 8 x 20 μs		Typical Capacitance f = 1MHz	
			V _{RMS}	V _{DC}	Energy 10 x 1000 μs	Peak Current 8 x 20 μs		V _{NOM Min}	V _{NOM Max}		V _C
			V _{M(AC)}	V _{M(DC)}	W _{TM}	I _{TM}	(V)	(V)	(V)	(A)	C
(V)	(V)	(J)	(A)	(V)	(V)	(V)	(A)	(pF)			
V385LA10P	P385L	10	385	505	51	2500	558	682	1025	25	160
V385LA20AP	P385L20	14	385	505	85	4500	558	682	1025	50	360
V385LA40BP	P385L40	20	385	505	160	6500	558	682	1025	100	700
V420LA7P	P4207	7	420	560	30	1200	612	748	1120	10	55
V420LA10P	P420L	10	420	560	55	2500	612	748	1120	25	140
V420LA20AP	P420L20	14	420	560	90	4500	612	748	1120	50	300
V420LA40BP	P420L40	20	420	560	160	6500	610	720	1060	100	600
V460LA7P	P4607	7	460	615	37	1200	643.5	786.5	1190	10	55
V460LA10P	P460L	10	460	615	56	2500	643.5	786.5	1190	25	120
V460LA20AP	P460L20	14	460	615	100	4500	643.5	786.5	1190	50	280
V460LA40BP	P460L40	20	460	615	170	6500	643.5	755.5	1110	100	560
V480LA7P	P4807	7	480	640	35	1200	675	825	1240	10	50
V480LA10P	P480L	10	480	640	60	2500	675	825	1240	25	120
V480LA40AP	P480L40	14	480	640	105	4500	675	825	1240	50	270
V480LA80BP	P480L80	20	480	640	180	6500	675	790	1160	100	550
V510LA10P	P510L	10	510	675	63	2500	738	902	1350	25	100
V510LA40AP	P510L40	14	510	675	110	4500	738	902	1350	50	250
V510LA80BP	P510L80	20	510	675	190	6500	738	860	1280	100	500
V575LA10P	P575L	10	575	730	65	2500	819	1001	1500	25	90
V575LA40AP	P575L40	14	575	730	120	4500	819	1001	1500	50	220
V575LA80BP	P575L80	20	575	730	220	6500	819	960	1410	100	450
V625LA10P	P625L	10	625	825	67	2500	900	1100	1650	25	80
V625LA40AP	P625L40	14	625	825	125	4500	900	1100	1650	50	210
V625LA80BP	P625L80	20	625	825	230	6500	900	1100	1650	100	425
V680LA10P	P680L	10	680	875	75	2500	990	1210	1875	25	65
V680LA80AP	P680L80	14	680	875	145	4500	990	1210	1875	50	190
V680LA100BP	P680L100	20	680	875	260	6500	990	1130	1700	100	380
V660LA10P	P660L	10	660	850	70	2500	972	1188	1820	25	70
V660LA50AP	P660L50	14	660	850	140	4500	972	1188	1820	50	200
V660LA100BP	P660L100	20	660	850	250	6500	940	1100	1650	100	400
V1000LA80AP	P1000L8	14	1000	1200	220	4500	1500	1800	2700	50	130
V1000LA160BP	P1000L16	20	1000	1200	360	6500	1425	1600	2420	100	250

NOTE: Average power dissipation of transients not to exceed 0.25W, 0.4W, 0.6W or 1W for model sizes 7mm, 10mm, 14mm and 20mm, respectively.

Phenolic Coating Option -- LA Series Varistors for Hi-Temperature Operating Conditions:

- Phenolic-coated LA Series devices are available with improved maximum operating maximum temperature 125°C.
- These devices also have improved temperature cycling performance capability.
- Ratings and Specifications are as per standard LA Series except Hi-Pot Encapsulation (Isolation Voltage Capability) = 500V.
- These devices are not UL, CSA, VDE or CECC certified.
- To order: add X1347 to end of part number (e.g. V230LA20APX1347).
- Product marking:

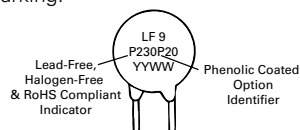

Copper Electrode Option:

- Add 'W' to the end of the part number (e.g. V230LA20AP**W**)
- Product marking

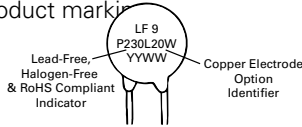

Current Energy and Power Dissipation Ratings

Should transients occur in rapid succession, the average power dissipation is the energy (watt-seconds) per pulse times the number of pulses per second. The power so developed must be within the specifications shown on the Device Ratings and Specifications Table for the specific

device. The operating values of a MOV need to be derated at high temperatures as shown above. Because varistors only dissipate a relatively small amount of average power they are not suitable for repetitive applications that involve substantial amounts of average power dissipation.

Figure 1A - Power Derating for Epoxy Coated

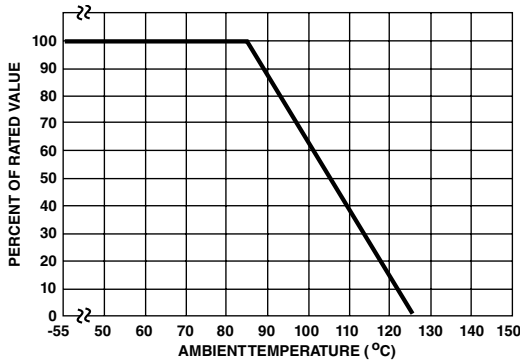
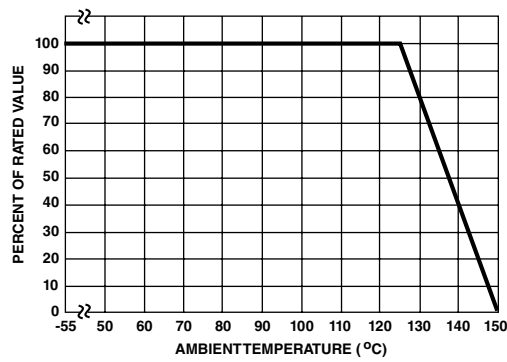

Figure 1B - Power Derating for Phenolic Coated



Peak Pulse Current Test Waveform

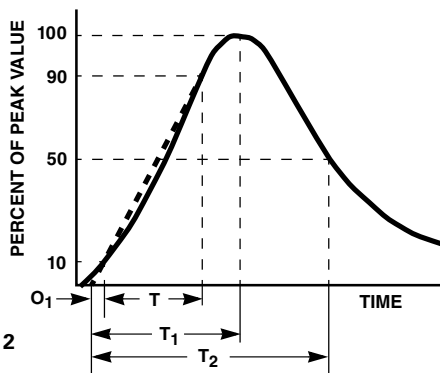

Figure 2

- O₁ = Virtual Origin of Wave
- T = Time from 10% to 90% of Peak
- T₁ = Rise Time = 1.25 x T
- T₂ = Decay Time

Example - For an 8/20 μs Current Waveform:

- 8 μs = T₁ = Rise Time
- 20 μs = T₂ = Decay Time

Transient V-I Characteristics Curves

Maximum Clamping Voltage for 7mm Parts

V130LA1(P) - V300LA2(P)

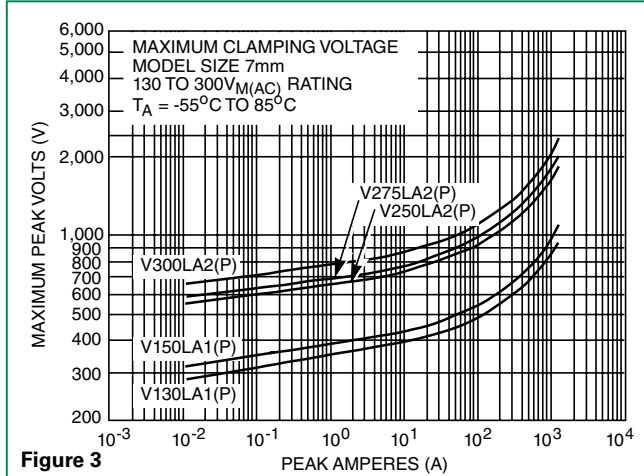

Figure 3

V130LA2(P) - V300LA4(P)

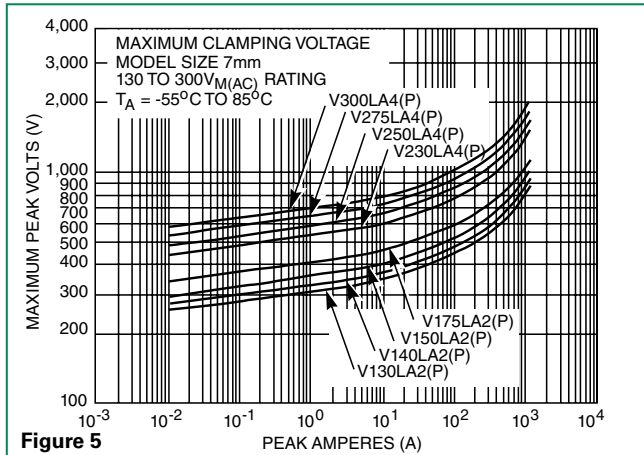

Figure 5

V320LA7(P) - V480LA7(P)

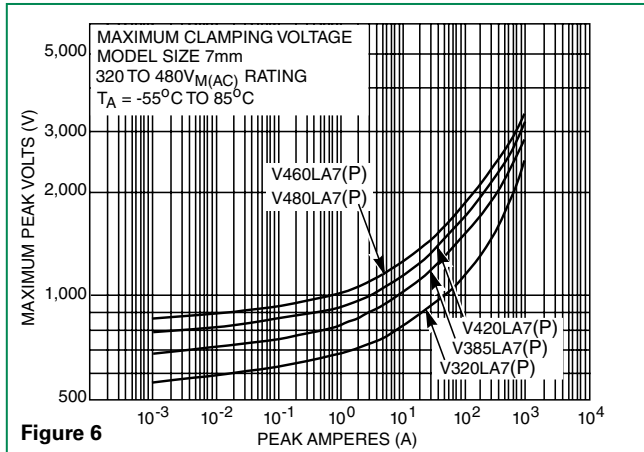

Figure 6

Pulse Rating Curves

Repetitive Surge Capability for 7mm Parts

V130LA1(P) - V480LA7(P)

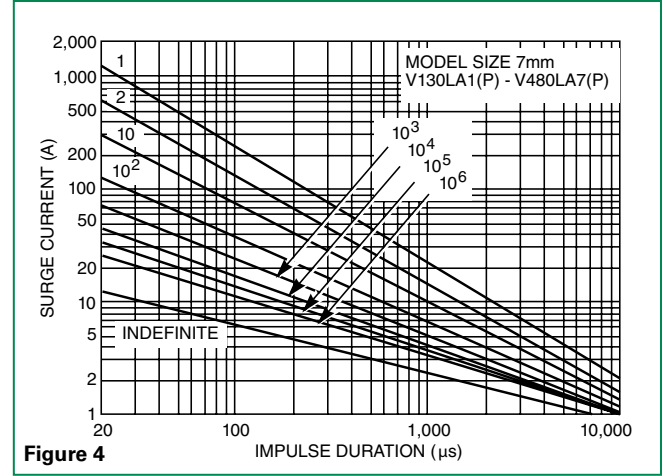

Figure 4

Transient V-I Characteristics Curves (Continued...)

Maximum Clamping Voltage for 10mm Parts

V130LA5(P) - V420LA10(P)

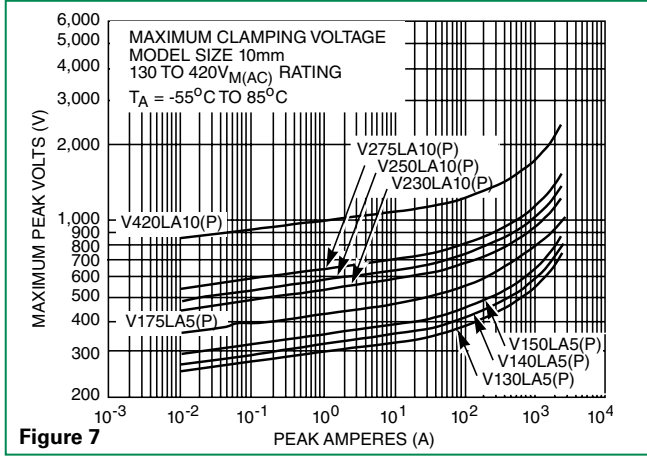

Figure 7

Pulse Rating Curves (Continued...)

Repetitive Surge Capability for 10mm Parts

V130LA5(P) - V680LA10(P)

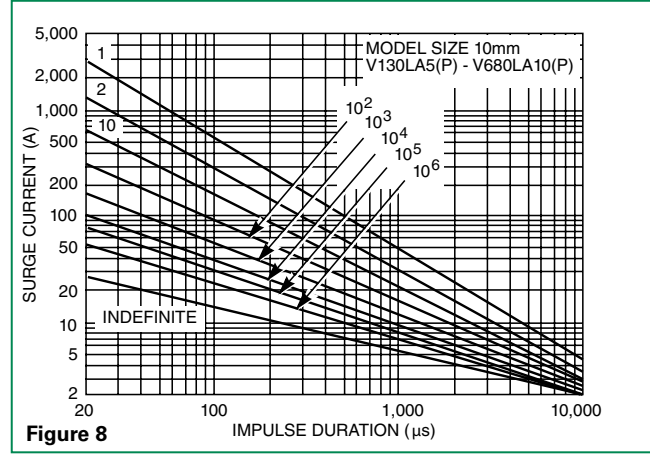

Figure 8

V300LA10(P) - V680LA10(P)

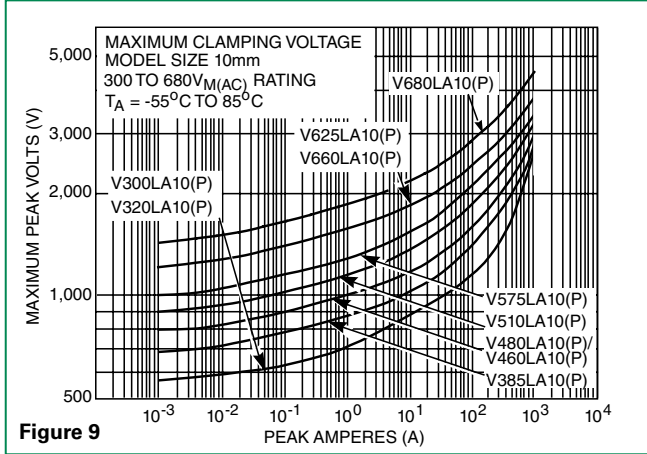

Figure 9

Transient V-I Characteristics Curves (Continued...)

Maximum Clamping Voltage for 14mm Parts

V130LA10A(P) - V320LA20A

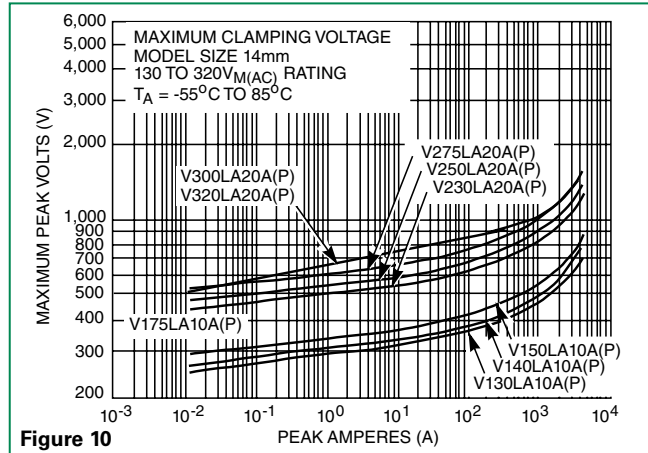

Figure 10

V385LA20A(P) V1000LA80A(P)

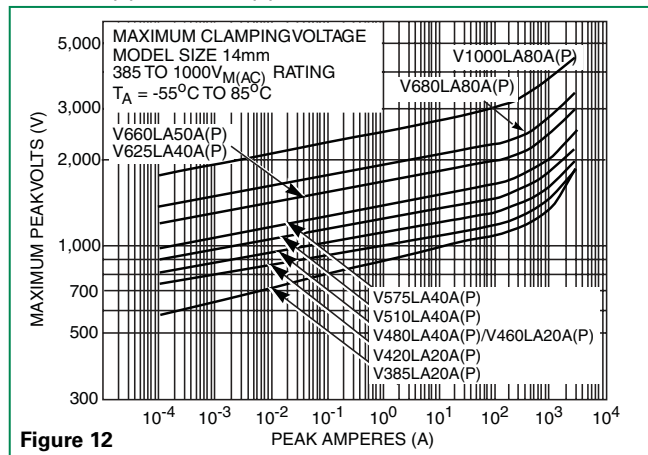

Figure 12

Pulse Rating Curves (Continued...)

Repetitive Surge Capability for 14mm Parts

V130LA10A(P) - V320LA20A(P)

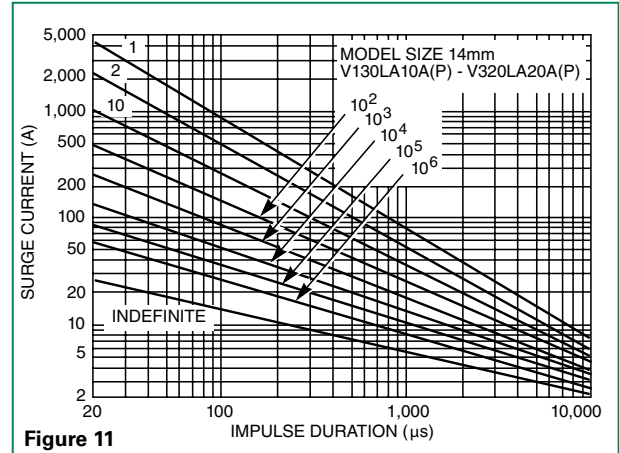

Figure 11

V385LA20A(P) - V1000LA80A(P)

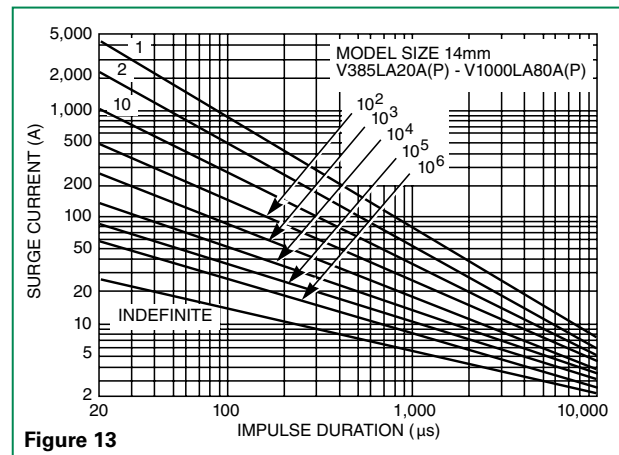

Figure 13

Transient V-I Characteristics Curves (Continued...)

Maximum Clamping Voltage for 20mm Parts

V130LA20A(P) - V275LA40A(P)

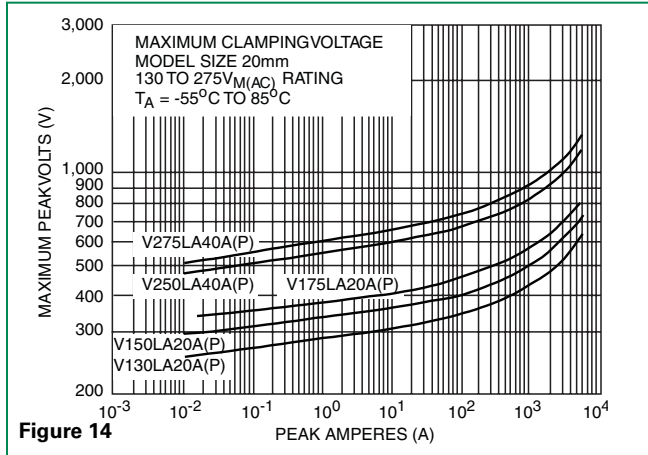

Figure 14

Pulse Rating Curves (Continued...)

V300LA40A - V1000LA160B

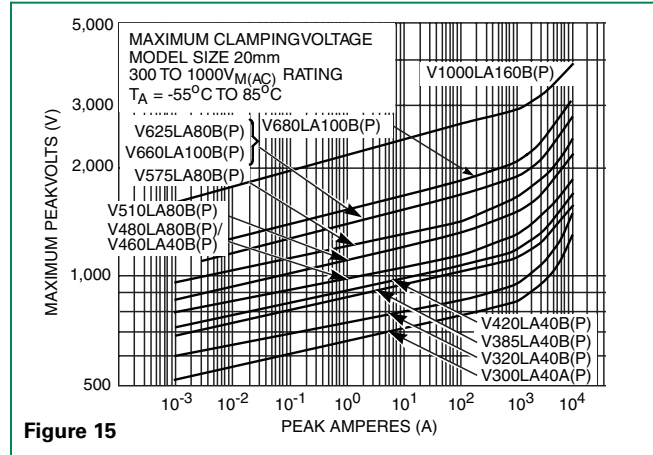

Figure 15

V130LA20B(P) - V275LA40(P)

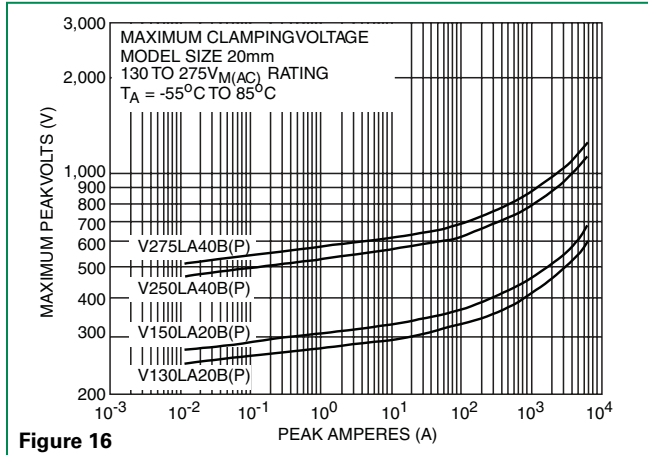

Figure 16

Repetitive Surge Capability for 20mm Parts

V130LA20A(P) - V320LA40B(P)

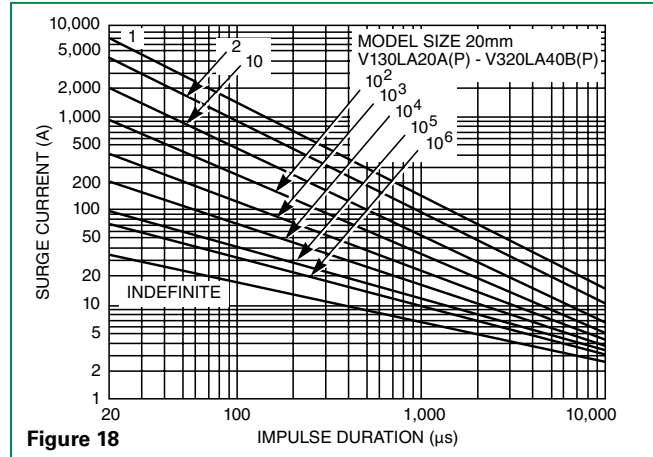

Figure 18

V130LA20A(P) - V275LA40A(P)

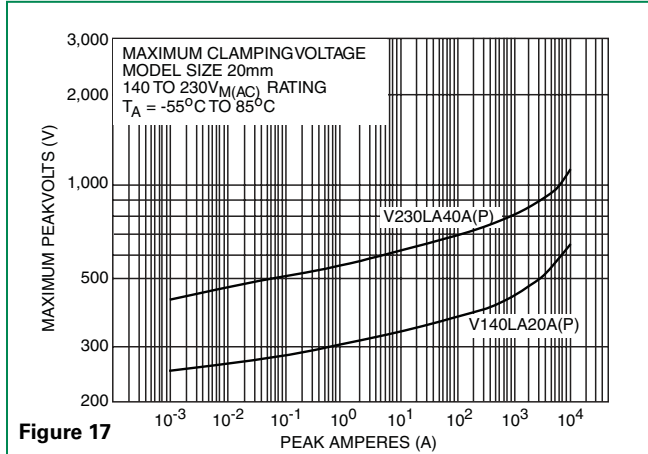

Figure 17

V385LA40B(P) - V1000LA160B(P)

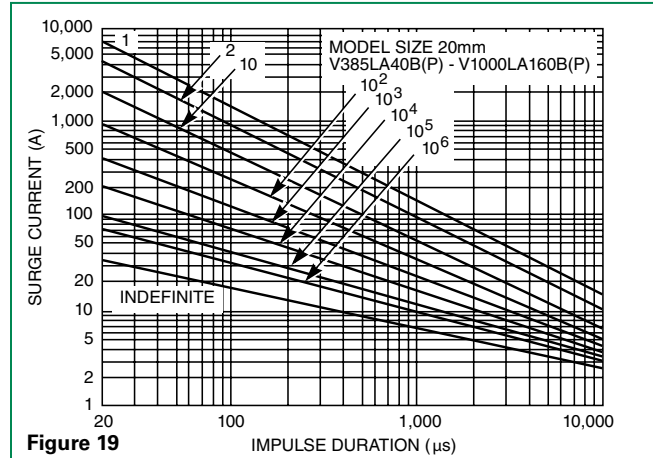
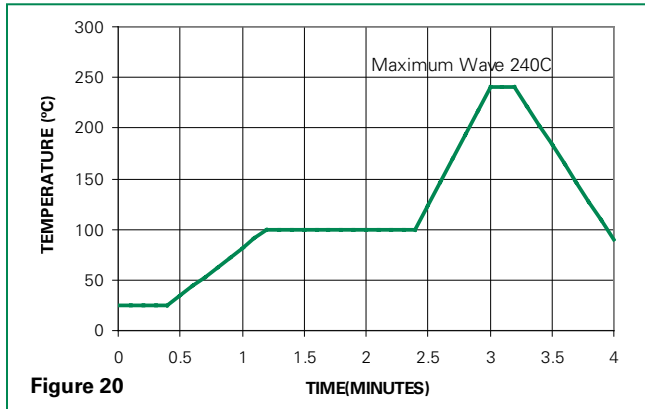

Figure 19

NOTE: If pulse ratings are exceeded, a shift of V_{NDCI} (at specified current) of more than +/-10% could result. This type of shift, which normally results in a decrease of V_{NDCI} , may result in the device not meeting the original published specifications, but does not prevent the device from continuing to function, and to provide ample protection.

Wave Solder Profile

Non Lead-free Profile



Lead-free Profile

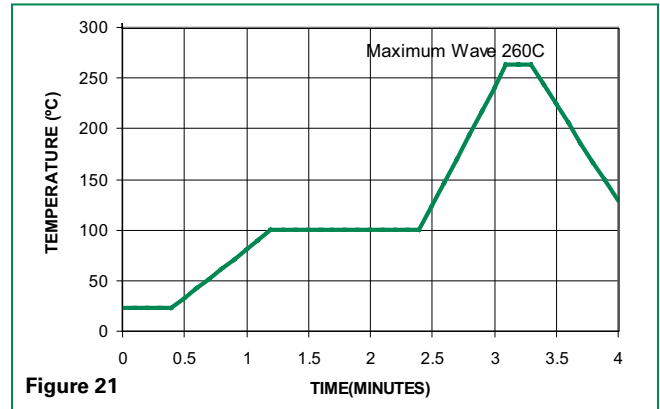

Physical Specifications

Lead Material	Copper Clad Steel Wire
Soldering Characteristics	Solderability per MIL-STD-202, Method 208
Insulating Material	Cured, flame retardant epoxy polymer meets UL94V-0 requirements
Device Labeling	Marked with LF, voltage, UL/CSA logos, and date code

Environmental Specifications

Operating Ambient Temperature Range	-55°C to +85°C
Storage Temperature Range	-55°C to +125°C
Humidity Aging	+85°C, 85% RH, 1000 hours +/-10% typical voltage change
Thermal Shock	+85°C to -40°C 5 times +/-10% typical voltage change
Solvent Resistance	MIL-STD-202, Method 215
Moisture Sensitivity	Level 1, J-STD-020

Product Dimensions (mm)

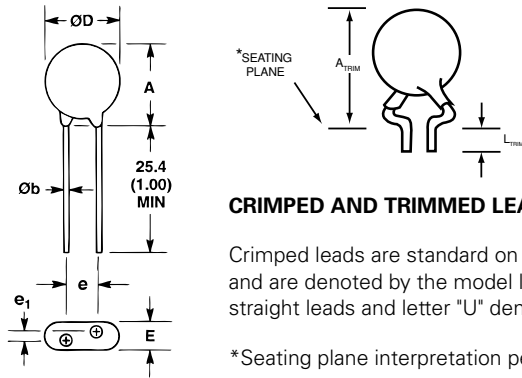

CRIMPED AND TRIMMED LEAD

Crimped leads are standard on LA types supplied in tape and reel and are denoted by the model letter "T." Model letter "S" denotes straight leads and letter "U" denotes special under-crimped leads.

*Seating plane interpretation per IEC-717

Dimension	V _{RMS} Voltage Model	7mm Size		10mm Size		14mm Size		20mm Size	
		Min. mm (in)	Max. mm (in)	Min. mm (in)	Max. mm (in)	Min. mm (in)	Max. mm (in)	Min. mm (in)	Max. mm (in)
A	V130LA-V320LA	-	12 (0.472)	-	16 (0.630)	-	20 (0.787)	-	26.5 (1.043)
	V385LA-V1000LA	-	13 (0.512)	-	17 (0.689)	-	20.5 (0.807)	-	28 (1.102)
ØD	All	-	9 (0.354)	-	12.5 (0.492)	-	17 (0.669)	-	23 (0.906)
e	All	4 (0.157)	6 (0.236)	6.5 (0.256)	8.5 (0.335)	6.5 (0.256)	8.5 (0.335)	6.5 (0.256) (Note 2)	8.5 (Note 2)
e ₁	V130LA-V320LA	1.5 (0.059)	3.5 (0.138)	1.5 (0.059)	3.5 (0.138)	1.5 (0.059)	3.5 (0.138)	1.5 (0.059)	3.5 (0.138)
	V385LA-V1000LA	2.5 (0.098)	5.5 (0.217)	2.5 (0.098)	5.5 (0.217)	2.5 (0.098)	5.5 (0.217)	2.5 (0.098)	5.5 (0.217)
E	V130LA-V320LA	-	5.6 (0.220)	-	5.6 (0.220)	-	5.6 (0.220)	-	5.6 (0.220)
	V385LA-V510LA	-	7.3 (0.287)	-	7.3 (0.287)	-	7.3 (0.287)	-	7.3 (0.287)
	V550LA-V680LA	-	8.3 (0.327)	-	8.3 (0.327)	-	8.3 (0.327)	-	8.3 (0.327)
	V1000LA	-	-	-	-	-	10.8 (0.425)	-	10.8 (0.425)
øb	All (Note 3)	0.585 (0.023)	0.685 (0.027)	0.76 (0.030)	0.86 (0.034)	0.76 (0.030)	0.86 (0.034)	0.76 (0.030) (Note 2)	0.86 (0.034) (Note 2)
A _{TRIM}	All	-	15 (0.591)	-	19.5 (0.768)	-	22.5 (0.886) (NOTE 4)	-	29.0 (1.142)
L _{TRIM}	All	2.41 (0.095)	4.69 (0.185)	2.41 (0.095)	4.69 (0.185)	2.41 (0.095)	4.69 (0.185)	2.41 (0.095)	4.69 (0.185)

Notes :

- Dimensions in millimeters, (inches) in parentheses.
- 10mm (9mm Min. & 11mm Max.) ALSO AVAILABLE; see additional lead style options
- 1000V parts supplied with lead wire of diameter 1.00 +/- 0.05 (0.039 +/- 0.002)
- 'A' Max. for V1000LC80A (P) = 24.00 (0.945")

Tape and Reel Specifications

(Dimensions presented on following page.)

7mm Devices

CRIMPED LEADS "LT"

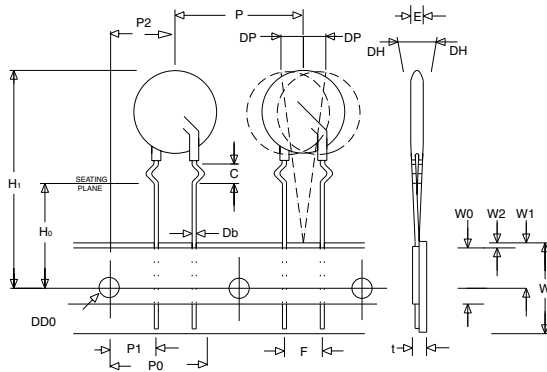

STRAIGHT LEADS "LS"

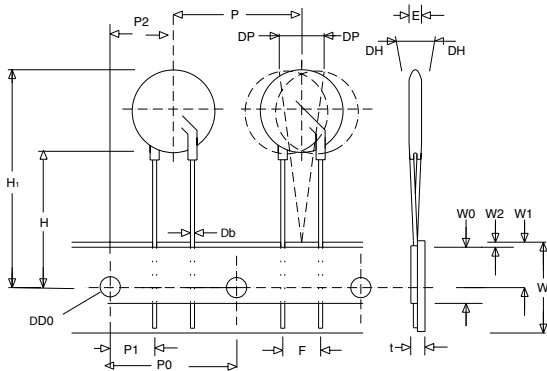

UNDER-CRIMPED LEADS "LU"

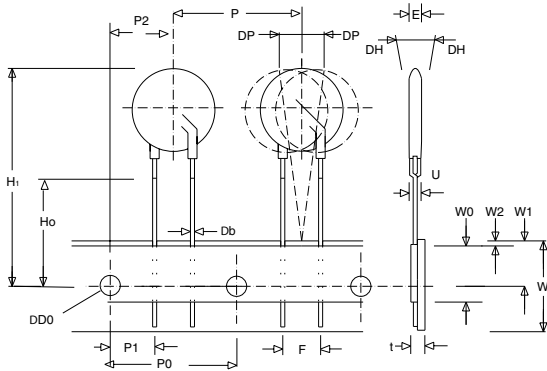

10, 14 and 20mm Devices

CRIMPED LEADS "LT"

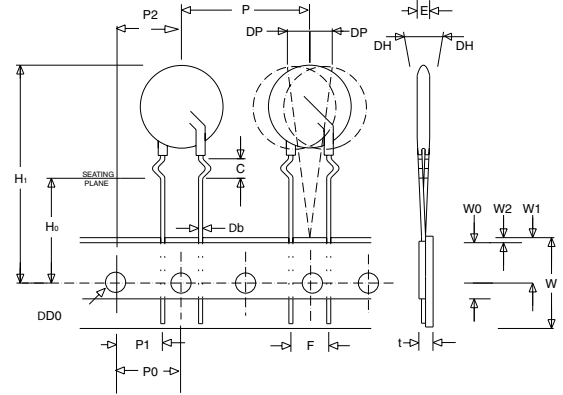

STRAIGHT LEADS "LS"

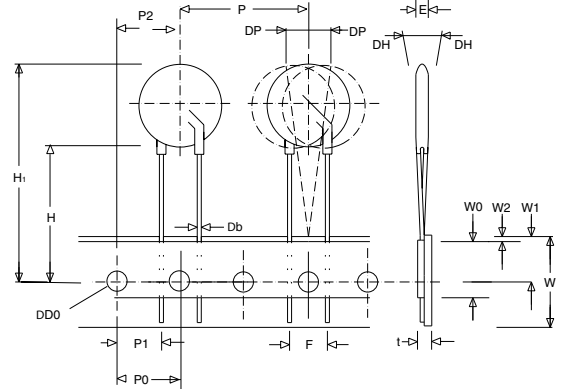

UNDER-CRIMPED LEADS "LU"

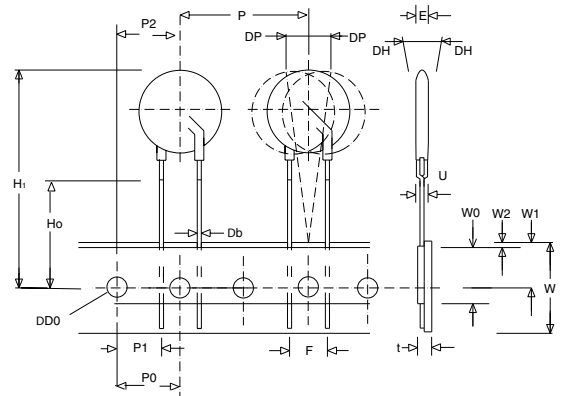

Tape and Reel Specifications (continued)

- Can be supplied to IEC Publication 286-2
- Radial devices on tape are supplied with crimped leads, straight leads, or under-crimped leads
- 7mm parts are available on tape and reel up to 480 VAC only
- 10mm parts are available on tape and reel up to 510 VAC only
- 14mm and 20mm parts are available on tape and reel up to 550 VAC only

Symbol	Description	Model Size			
		7mm	10mm	14mm	20mm
P	Pitch of Component	12.7 +/- 1.0	25.4 +/- 1.0	25.4 +/- 1.0	25.4 +/- 1.0
P₀	Feed Hole Pitch	12.7 +/- 0.2	12.7 +/- 0.2	12.7 +/- 0.2	12.7 +/- 0.2
P₁	Feed Hole Center to Pitch	3.85 +/- 0.7	8.85 +/- 0.7	8.85 +/- 0.7	8.85 +/- 0.7
P₂	Hole Center to Component Center	6.35 +/- 0.7	12.7 +/- 0.7	12.7 +/- 0.7	12.7 +/- 0.7
F	Lead to Lead Distance	5.0 +/- 0.8	7.5 +/- 0.8	7.5 +/- 0.8	7.5 +/- 0.8
h	Component Alignment	2.0 Max	2.0 Max	2.0 Max	2.0 Max
W	Tape Width	18.0 +1.0 / -0.5	18.0 +1.0 / -0.5	18.0 +1.0 / -0.5	18.0 +1.0 / -0.5
W₀	Hold Down Tape Width	12.0 +/- 0.3	12.0 +/- 0.3	12.0 +/- 0.3	12.0 +/- 0.3
W₁	Hole Position	9.0 +0.75 / -0.50	9.0 +0.75 / -0.50	9.0 +0.75 / -0.50	9.0 +0.75 / -0.50
W₂	Hold Down Tape Position	0.5 Max	0.5 Max	0.5 Max	0.5 Max
H	Height from Tape Center to Component Base	18.0 +2.0 / -0.0	18.0 +2.0 / -0.0	18.0 +2.0 / -0.0	18.0 +2.0 / -0.0
H₀	Seating Plane Height	16.0 +/- 0.5	16.0 +/- 0.5	16.0 +/- 0.5	16.0 +/- 0.5
H₁	Component Height	32.0 Max	36.0 Max	40.0 Max	46.5 Max
D₀	Feed Hole Diameter	4.0 +/- 0.2	4.0 +/- 0.2	4.0 +/- 0.2	4.0 +/- 0.2
T	Total Tape Thickness	0.7 +/- 0.2	0.7 +/- 0.2	0.7 +/- 0.2	0.7 +/- 0.2
U	Under-crimp Width	8.0 Max	8.0 Max	8.0 Max	8.0 Max
P	Component Alignment	3° Max 1.00mm	3° Max 1.00mm	3° Max 1.00mm	3° Max

NOTE: Dimensions are in mm.

Standard Bulk Pack Quantity

Varistor Voltage Model	Standard Bulk Pack Quantity			
	Varistor Model Size			
	7mm	10mm	14mm	20mm
130-275	1500	1000	700	500
300-460	1500	1000	600	400
510-625	1500	1000	500	400
660	N/A	1000	500	400
680	N/A	1000	400	300
1000	N/A	N/A	300	200

Disclaimer Notice - Information furnished is believed to be accurate and reliable. However, users should independently evaluate the suitability of and test each product selected for their own applications. Littelfuse products are not designed for, and may not be used in, all applications. Read complete Disclaimer Notice at www.littelfuse.com/disclaimer-electronics.

Part Numbering System

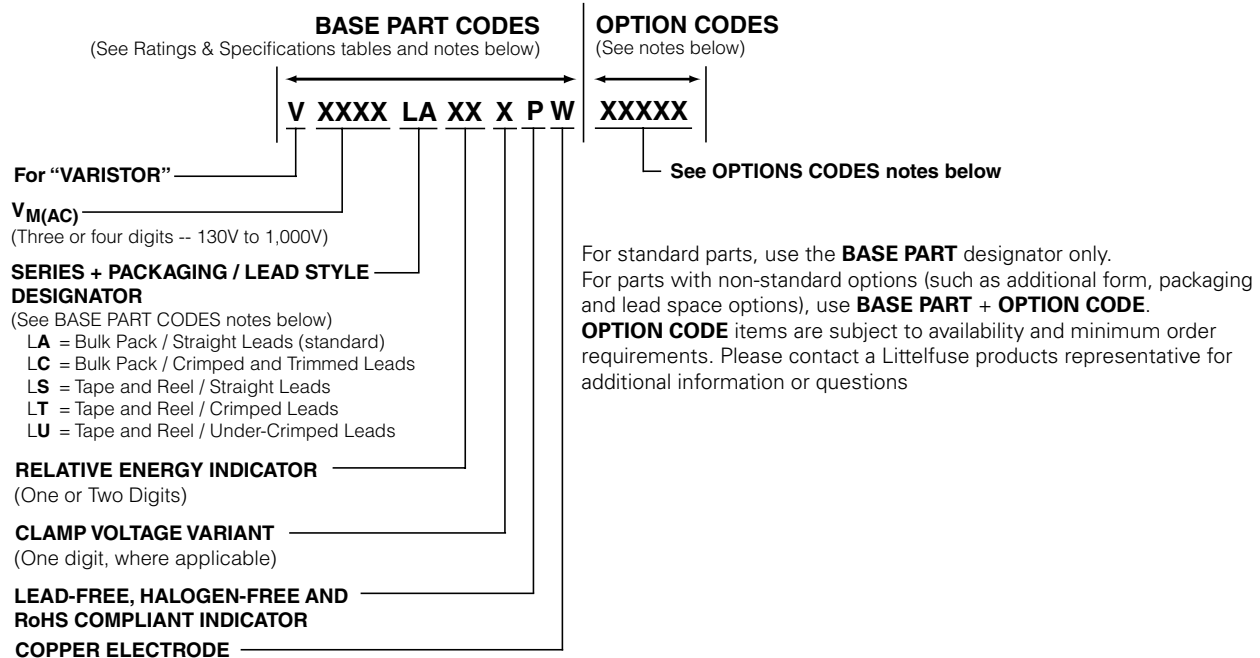

Ordering Notes:

BASE PART CODES:

Series + Packaging / Lead Style Designators:

Ordering examples:

Straight Lead Bulk Pack (standard)	Straight Lead Tape & Reel	Crimped Lead Tape & Reel	Crimped & Trimmed Lead Bulk Pack	Under-Crimp Lead Tape & Reel
V130 LA 2P	V130 LS 2P	V130 LT 2P	V130 LC 2P	V130 LU 2P

Crimped leads are standard on LA Series varistors supplied in tape and reel, denoted with "LT." For crimped leads without trimming and any variations other than that described above, please contact Littelfuse.

Littelfuse LA Series varistors are shipped standard in bulk pack with straight leads and lead spacing outlined in the Package Dimensions section of this data sheet. Contact your Littelfuse sales representative to discuss non-standard options.

OPTION CODES:

X10: 10mm lead spacing option –

For 10 (-/+1) mm lead spacing (available on 20mm diameter models only), append standard model BASE PART number with "X10." Example:

Standard Model	Order As
V130LA20AP	V130LA20AP X10

X2855: Nickel Barrier coated wire option –

All standard parts use tinned copper clad steel wire. Nickel Barrier coated wire is available as an option, consisting of Copper wire with a flashing of Nickel followed by a top coating of Tin. To order append standard model BASE PART number with "X2855." Example:

Standard Model	Order As
V130LA20AP	V130LA20AP X2855

X1347: Hi-Temperature phenolic coating option –

Phenolic Coated LA Series devices are available with improved maximum operating maximum temperature of 125°C.

To order, add X1347 to end of part number (Example: V230LA20AP**X1347**).

For additional information please refer to the section labeled "Phenolic Coating Option" on the third page of this document under the "Electrical Characteristics" table.

ZA Varistor Series





Description

The ZA Series of transient voltage surge suppressors are radial leaded varistors (MOVs) designed for use in the protection of low and medium-voltage circuits and systems. Typical applications include motor control, telecom, automotive systems, solenoid, and power supply circuits to protect circuit board components and maintain data integrity.

These devices are available in five model sizes: 5mm, 7mm, 10mm, 14mm and 20mm, and feature a wide V_{DC} voltage range of 5.5V to 615V.

See ZA Series Device Ratings and Specifications Table for part number and brand information.

Agency Approvals

Agency	Agency Approval	Agency File Number
	UL144*	E320116
	CECC 42201-006 IEC 61051-1 IEC 61051-2 IEC 60950-1 (Annex Q)**	116895
	CECC 42201-006 IEC 61051-1 IEC 61051-2 IEC 60950-1 (Annex Q)**	E1273/F

Notes:
 * - Except parts V8ZAxxP and V12ZAxxP.
 ** - For 14mm (V120 to V180) and 20mm (V120 to V180).

Features

- Lead-free, Halogen-Free and RoHS compliant
- Wide operating voltage range $V_{M(AC)RMS}$ 4V to 460V
- DC voltage ratings 5.5V to 615V
- No derating up to 85°C ambient
- 5 model sizes available: 5, 7, 10, 14, and 20mm
- Radial lead package for hard-wired or printed circuit board designs
- Available in tape and reel or bulk pack
- Standard lead form options

Additional Information



Datasheet



Resources



Samples

Absolute Maximum Ratings

• For ratings of individual members of a series, see Device Ratings and Specifications chart

Continuous	ZA Series	Units
Steady State Applied Voltage:		
AC Voltage Range ($V_{M(AC)RMS}$)	4 to 460	V
DC Voltage Range ($V_{M(DC)}$)	5.5 to 615	V
Transients:		
Peak Pulse Current (I_{TM}) For 8/20 μ s Current Wave (See Figure 2)	50 to 6500	A
Single Pulse Energy Range (Note 1) For 10/1000 μ s Current Wave (W_{TM})	0.1 to 52	J
Operating Ambient Temperature Range (T_A)	-55 to +85	°C
Storage Temperature Range (T_{STG})	-55 to +125	°C
Temperature Coefficient (α) of Clamping Voltage (V_C) at Specified Test Current	<0.01	%/°C
Hi-Pot Encapsulation (COATING Isolation Voltage Capability) (Dielectric must withstand indicated DC voltage for one minute per MIL-STD-202, Method 301)	2500	V
COATING Insulation Resistance	1000	M Ω

CAUTION: Stresses above those listed in "Absolute Maximum Ratings" may cause permanent damage to the device. This is a stress only rating and operation of the device at these or any other conditions above those indicated in the operational sections of this specification is not implied.

ZA Series Ratings & Specifications

Part Number	Branding	Model Size Disc Dia. (mm)	Maximum Rating (85°C)				Specifications (25°C)					
			Continuous		Transient		Varistor Voltage at 1mA DC Test Current		Maximum Clamping Voltage 8 x 20µs		Typical Capacitance f = 1MHz	
			V _{RMS}	V _{DC}	Energy 10 x 1000µs	Peak Current 8 x 20µs						
			V _{M(AC)}	V _{M(DC)}	W _{TM}	I _{TM}	V _{NOM} Min	V _{NOM} Max	V _C	I _{PK}	C	
(V)	(V)	(J)	(A)	(V)	(V)	(V)	(A)	(pF)				
V8ZA05P	PZ08	5	4	5.5	0.1	50	6	11	30	1	2000	
V8ZA1P	P08Z1	7	4	5.5	0.4	100	6	11	22	2.5	4190	
V8ZA2P	P08Z2	10	4	5.5	0.8	250	6	11	20	5	7000	
V12ZA05P	PZ12	5	6	8	0.14	50	9	16	37	1	1700	
V12ZA1P	P12Z1	7	6	8	0.6	100	9	16	34	2.5	3350	
V12ZA2P	P12Z2	10	6	8	1.2	250	9	16	30	5	6100	
V18ZA05P	PZ18	5	10	14	0.17	100	16.2	19.8	36	1	1400	
V18ZA1P	P18Z1	7	10	14	0.8	250	16.2	19.8	36	2.5	2700	
V18ZA2P	P18Z2	10	10	14	1.5	500	16.2	19.8	36	5	5300	
V18ZA3P	P18Z3	14	10	14	3.5	1000	16.2	19.8	36	10	18870	
V18ZA20P	P18Z20	20	10	14	10	2000	16.2	19.8	37	20	22000	
V18ZA40P	P18Z40	20	10	14	80 (Note 2)	2000	16.2 (Note 3)	19.8	37	20	22000	
V22ZA05P	PZ22	5	14	18	0.2	100	19.8	24.2	43	1	1220	
V22ZA1P	P22Z1	7	14	18	0.9	250	19.8	24.2	43	2.5	2375	
V22ZA2P	P22Z2	10	14	18	2	500	19.8	24.2	43	5	4500	
V22ZA3P	P22Z3	14	14	18	4	1000	19.8	24.2	43	10	14730	
V24ZA20P	P24Z20	20	14	18	12	2000	19.8	24.2	43	20	18000	
V24ZA50P	P24Z50	20	14	18 (Note 4)	100 (Note 2)	2000	20.7 (Note 3)	25.3	43	20	18000	
V27ZA05P	PZ27	5	17	22	0.25	100	24.3	29.7	53	1	920	
V27ZA1P	P27Z1	7	17	22	1	250	24.3	29.7	53	2.5	1875	
V27ZA2P	P27Z2	10	17	22	2.5	500	24.3	29.7	53	5	3850	
V27ZA4P	P27Z4	14	17	22	5	1000	24.3	29.7	53	10	11480	
V27ZA20P	P27Z20	20	17	22	14	2000	24.3	29.7	53	20	13000	
V27ZA60P	P27Z60	20	17	22	100 (Note 2)	2000	24.3 (Note 3)	29.7	50	20	13000	
V33ZA05P	PZ33	5	20	26	0.3	100	29.7	36.3	65	1	790	
V33ZA1P	P33Z1	7	20	26	1.2	250	29.7	36.3	65	2.5	1620	
V33ZA2P	P33Z2	10	20	26	3	500	29.7	36.3	65	5	3495	
V33ZA5P	P33Z5	14	20	26	6	1000	29.7	36.3	65	10	9290	
V33ZA20P	P33Z20	20	20	26	18	2000	29.7	36.3	65	20	13000	
V33ZA70P	P33Z70	20	21	27	100 (Note 2)	2000	29.7 (Note 3)	36.3	58	20	13000	
V36ZA20P	P36Z20	20	23	28	20	2000	32.4	39.6	70	20	12000	
V36ZA80P	P36Z80	20	23	28	100 (Note 2)	2000	32.4 (Note 3)	39.6	63	20	12000	
V39ZA05P	PZ39	5	25	31	0.3	100	35.1	42.9	79	1	675	
V39ZA1P	P39Z1	7	25	31	1.2	250	35.1	42.9	79	2.5	1350	
V39ZA3P	P39Z3	10	25	31	3	500	35.1	42.9	76	5	3100	
V39ZA6P	P39Z6	14	25	31	7.2	1000	35.1	42.9	76	10	7000	
V39ZA20P	P39Z20	20	25	31	20	2000	35.1	42.9	76	20	12000	
V47ZA05P	PZ47	5	30	38	0.4	100	42.3	51.7	93	1	585	
V47ZA1P	P47Z1	7	30	38	1.8	250	42.3	51.7	93	2.5	1245	
V47ZA3P	P47Z3	10	30	38	4.5	500	42.3	51.7	93	5	2590	
V47ZA7P	P47Z7	14	30	38	8.8	1000	42.3	51.7	93	10	6270	
V47ZA20P	P47Z20	20	30	38 (Note 6)	23 (Note 7)	2000	42.3	51.7	93	20	11000	

ZA Series Ratings & Specifications (Continued...)

Part Number	Branding	Model Size Disc Dia. (mm)	Maximum Rating (85°C)				Specifications (25°C)				
			Continuous		Transient		Varistor Voltage at 1mA DC Test Current		Maximum Clamping Voltage 8 x 20µs		Typical Capaci- tance f = 1MHz
			V _{RMS}	V _{DC}	Energy 10 x 1000µs	Peak Current 8 x 20µs					
			V _{M(AC)}	V _{M(DC)}	W _{TM}	I _{TM}	V _{NOM} Min	V _{NOM} Max	V _C	I _{PK}	C
(V)	(V)	(J)	(A)	(V)	(V)	(V)	(A)	(pF)			
V56ZA05P	PZ56	5	35	45	0.5	100	50.4	61.6	110	1	500
V56ZA2P	P56Z2	7	35	45	2.3	250	50.4	61.6	110	2.5	1035
V56ZA3P	P56Z3	10	35	45	5.5	500	50.4	61.6	110	5	2150
V56ZA8P	P56Z8	14	35	45	10	1000	50.4	61.6	110	10	4840
V56ZA20P	P56Z20	20	35	45	30	2000	50.4	61.6	110	20	10000
V68ZA05P	PZ68	5	40	56	0.6	100	61.2	74.8	135	1	400
V68ZA2P	P68Z2	7	40	56	3	250	61.2	74.8	135	2.5	910
V68ZA3P	P68Z3	10	40	56	6.5	500	61.2	74.8	135	5	1850
V68ZA10P	P68Z10	14	40	56	13	1000	61.2	74.8	135	10	3870
V68ZA20P	P68Z20	20	40	56	33	2000	61.2	74.8	135	20	9000
V82ZA05P	PZ82	5	50	68	2	400	73.8	90.2	135	5	355
V82ZA2P	P82Z2	7	50	68	4	1200	73.8	90.2	135	10	700
V82ZA4P	P82Z4	10	50	68	8	2500	73.8	90.2	135	25	1485
V82ZA12P	P82Z12	14	50	68	15	4500	73.8	90.2	145	50	3380
V82ZA20P	P82Z20	20	50	68	25	6500	73.8	90.2	145	100	7000
V100ZA05P	PZ100	5	60	81	2.5	400	90	110	165	5	310
V100ZA3P	P100Z	7	60	81	5	1200	90	110	165	10	600
V100ZA4P	P100Z4	10	60	81	10	2500	90	110	165	25	1200
V100ZA15P	P100Z15	14	60	81	20	4500	90	110	175	50	2900
V100ZA20P	P100Z20	20	60	81	30	6500	90	110	175	100	6500
V120ZA05P	PZ120	5	75	102	3	400	108	132	205	5	250
V120ZA1P	P120Z	7	75	102	6	1200	108	132	205	10	515
V120ZA4P	P120Z4	10	75	102	12	2500	108	132	200	25	1100
V120ZA6P	P120Z6	14	75	102	22	4500	108	132	210	50	2450
V120ZA20P	P120Z20	20	75	102	33	6500	108	132	210	100	5000
V150ZA05P	PZ150	5	92	127	4	400	135	165	250	5	190
V150ZA1P	PZ051	7	95	127	8	1200	135	165	250	10	460
V150ZA4P	P150Z4	10	95	127	15	2500	135	165	250	25	860
V150ZA8P	P150Z8	14	95	127	20	4500	135	165	250	50	1910
V150ZA20P	P150Z20	20	95	127	45	6500	135	165	250	100	3500
V180ZA05P	PZ180	5	110	153	5	400	162	198	295	5	100
V180ZA1P	P180Z	7	115	153	10	1200	162	198	300	10	320
V180ZA5P	P180Z5	10	115	153	18	2500	162	198	300	25	465
V180ZA10P	P180Z10	14	115	153	35	4500	162	198	300	50	1190
V180ZA20P	P180Z20	20	115	153	52	6500	162	198	300	100	2400
V205ZA05P	PZ205	5	130	170	5.5	400	184.5	225.5	340	5	100
V220ZA05P	PZ220	5	140	180	6	400	198	242	360	5	95
*V240ZA05P	PZ240	5	150	200	7	400	216	264	395	5	90
*V270ZA05P	PZ270	5	175	225	7.5	400	243	297	455	5	75
*V330ZA05P	PZ330	5	210	275	9	400	306	374	540	5	70
*V360ZA05P	PZ360	5	230	300	9.5	400	324	396	595	5	60
*V390ZA05P	PZ390	5	250	330	10	400	351	429	650	5	80
*V430ZA05P	PZ430	5	275	369	11	400	387	473	710	5	75
*V470ZA05P	PZ470	5	300	385	12	400	423	517	775	5	70
*V620ZA05P	PZ620	5	385	505	13	400	558	682	1025	5	45
*V680ZA05P	PZ680	5	420	560	14	400	612	748	1120	5	40
*V715ZA05P	PZ715	5	440	585	15.5	400	643.5	786.5	1180	5	35
*V750ZA05P	PZ750	5	460	615	17	400	675	825	1240	5	30

Note:

- Average power dissipation of transients not to exceed 0.2W, 0.25W, 0.4W, 0.6W or 1W for model sizes 5mm, 7mm, 10mm, 14mm and 20mm, respectively.
- Energy rating (auto load dump) for impulse duration of 40ms minimum to one half of peak current, 60 sec interval (ISO7637-2 pulse 5a and ISO16750-2 Table 5A)
- 10mA DC test current.
- Also rated to withstand 24V for 5 minutes.

5. Higher voltages available, contact Littelfuse.

6. Also rated to withstand 48V for 5 minutes.

7. Energy rating for impulse duration of 30ms minimum to one half of peak current (Auto Load Dump): 100J

8. The typical capacitance rating is the discrete component test result.

† Also Recognized to UL 1449, Transient Voltage Surge Suppressors File E320116

Phenolic Coating Option -- ZA Series Varistors for Hi-Temperature Operating Conditions:

- Phenolic coated ZA Series devices are available with improved maximum operating temperature of 125°C
- These devices also have improved temperature cycling performance capability
- Ratings and specifications are as per standard ZA Series except Hi-Pot Encapsulation (Isolation Voltage Capability) = 500V
- To order: add 'X1347' to part number (e.g. V22ZA3PX1347)
- These devices are not UL, VDE or CECC certified
- Contact factory for further details
- Product marking:

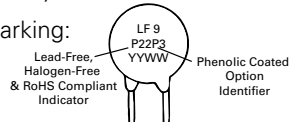

Copper Electrode Option:

- Add 'W' to the end of the part number (e.g. V240ZA05PW)
- Copper electrode option is only available for V240~V750 for ZA series.
- Product marking:

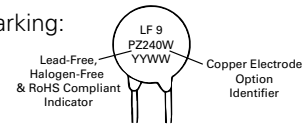

Current Energy and Power Dissipation Ratings

Should transients occur in rapid succession, the average power dissipation is the energy (watt-seconds) per pulse times the number of pulses per second. The power so developed must be within the specifications shown on the Device Ratings and Specifications Table for the specific

device. The operating values of a MOV need to be derated at high temperatures as shown above. Because varistors only dissipate a relatively small amount of average power they are not suitable for repetitive applications that involve substantial amounts of average power dissipation.

Figure 1A - Power Derating for Epoxy Coated

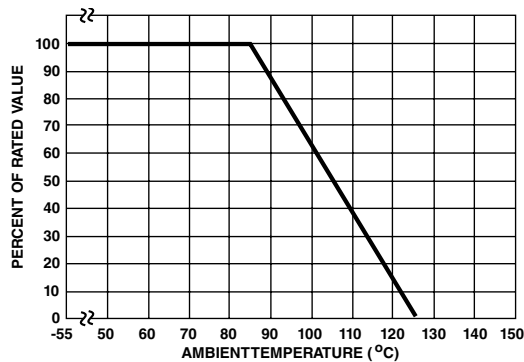
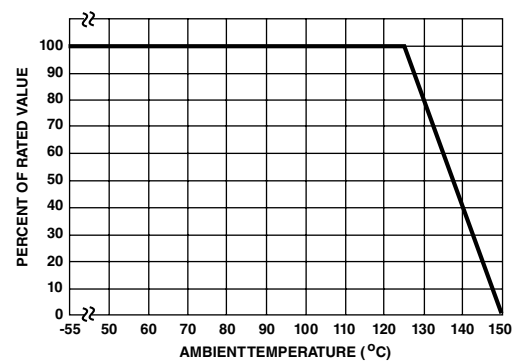
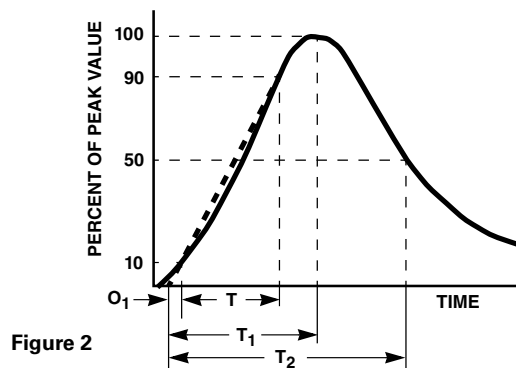

Figure 1B - Power Derating for Phenolic Coated



Peak Pulse Current Test Waveform



O_1 = Virtual Origin of Wave
 T = Time from 10% to 90% of Peak
 T_1 = Rise Time = $1.25 \times T$
 T_2 = Decay Time

Example - For an $8/20 \mu s$ Current Waveform:

$8 \mu s = T_1$ = Rise Time

$20 \mu s = T_2$ = Decay Time

Maximum Clamping Voltage for 5mm Parts

V8ZA05(P) - V68ZA05(P)

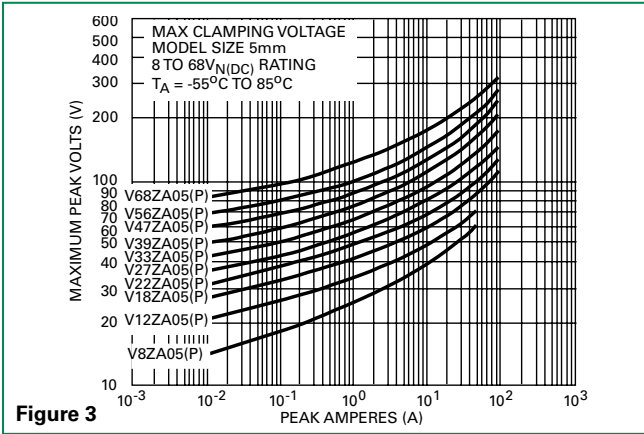

V82ZA05(P) - V33ZA05(P)

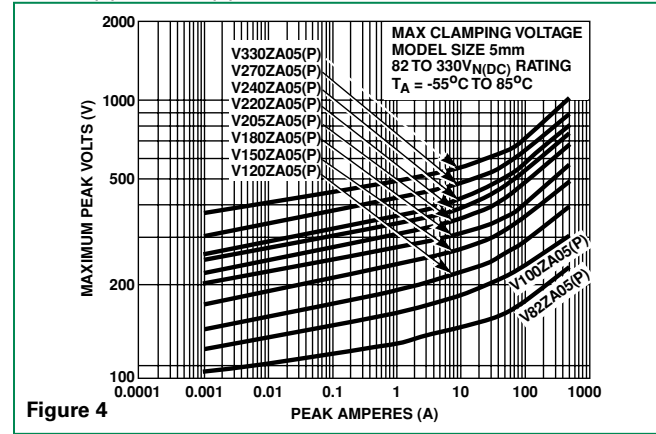

V360ZA05(P) - V750ZA05(P)

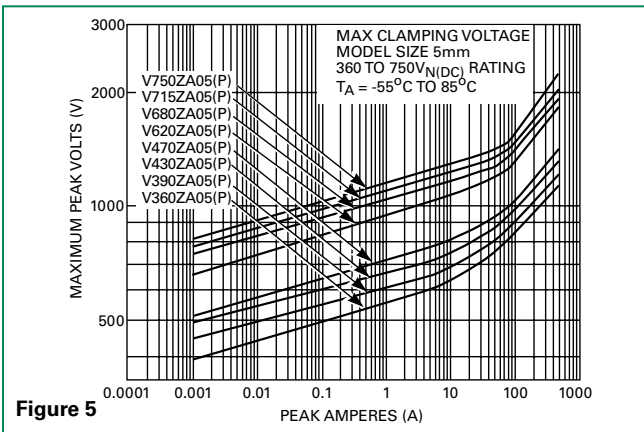

Maximum Clamping Voltage for 7mm Parts

V8ZA1(P) - V68ZA2(P)

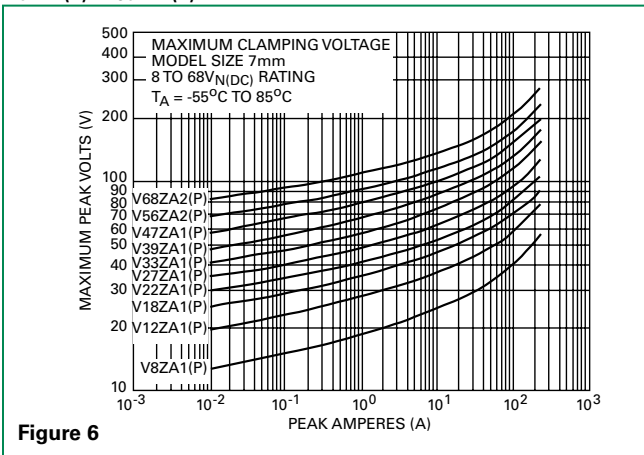

V82ZA2(P) - V180ZA1(P)

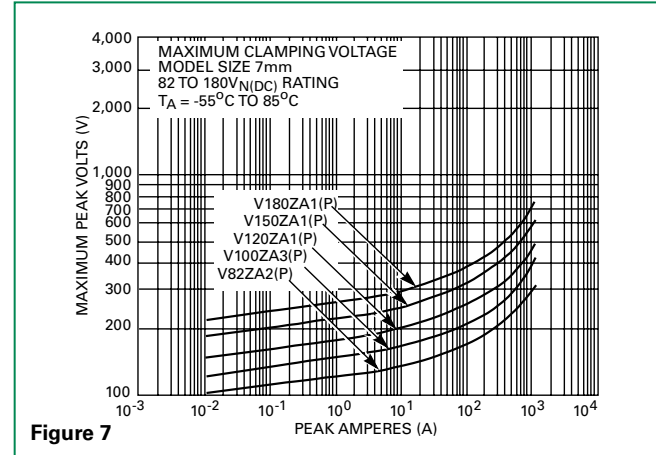

Maximum Clamping Voltage for 10mm Parts

V8ZA2(P) - V68ZA3(P)

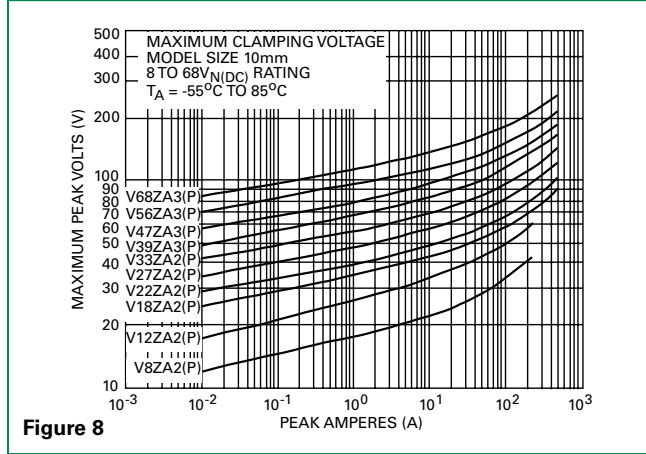

Figure 8

V82ZA4(P) - V180ZA5(P)

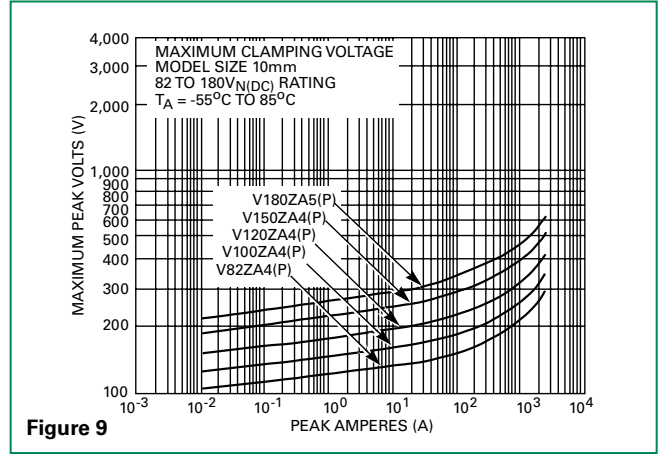

Figure 9

Maximum Clamping Voltage for 14mm Parts

V18ZA3(P) - V68ZA10(P)

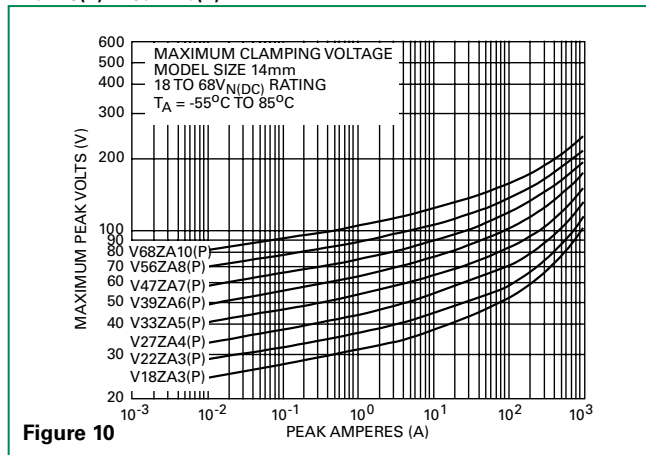

Figure 10

V82ZA12(P) - V180ZA10(P)

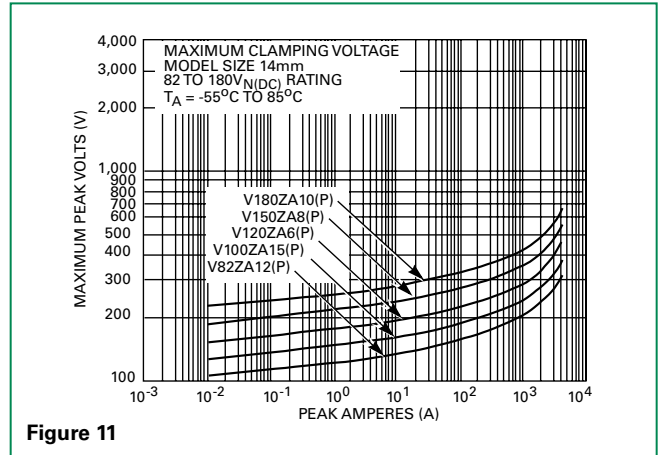

Figure 11

Maximum Clamping Voltage for 20mm Parts

V18ZA20(P) - V36ZA80(P)

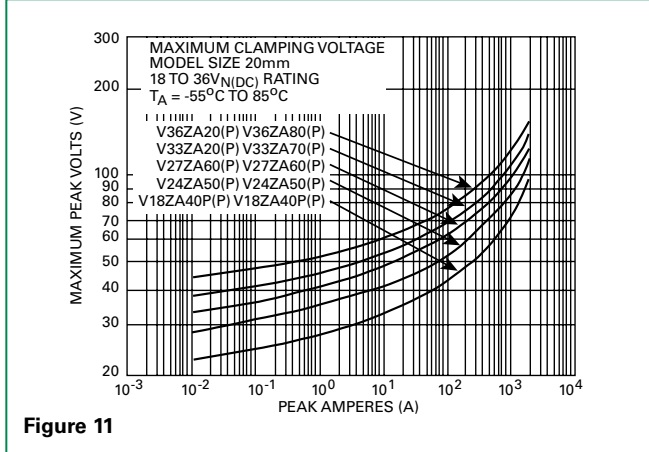

Figure 11

V39ZA20(P) - V180ZA20(P)

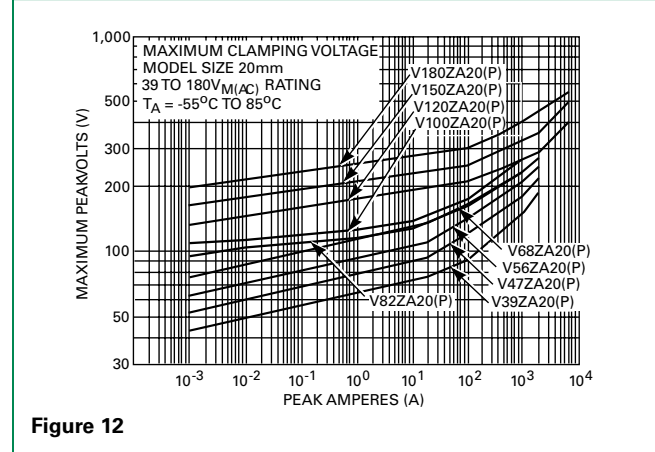

Figure 12

Repetitive Surge Capability for 5mm Parts

V8ZA05P - V12ZA05P

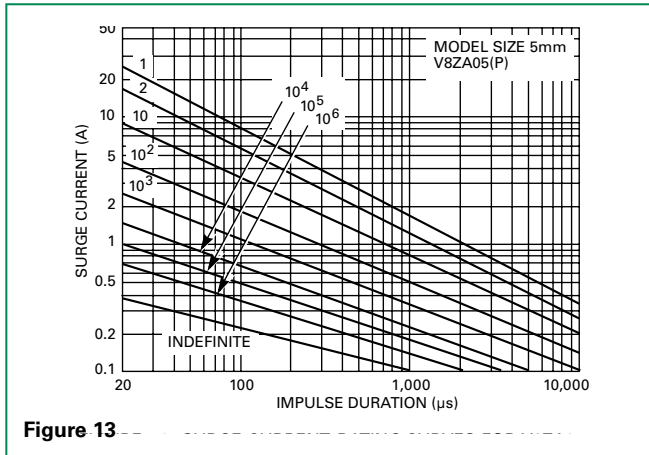

Figure 13

V18ZA05(P) - V68ZA05(P)

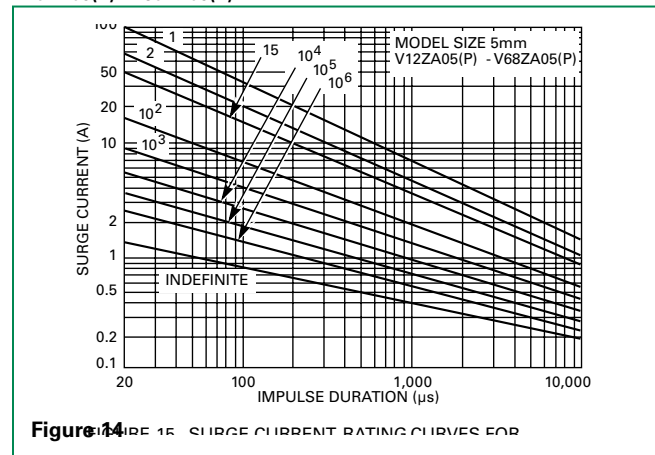

Figure 14

V82ZA05(P) - V750ZA05(P)

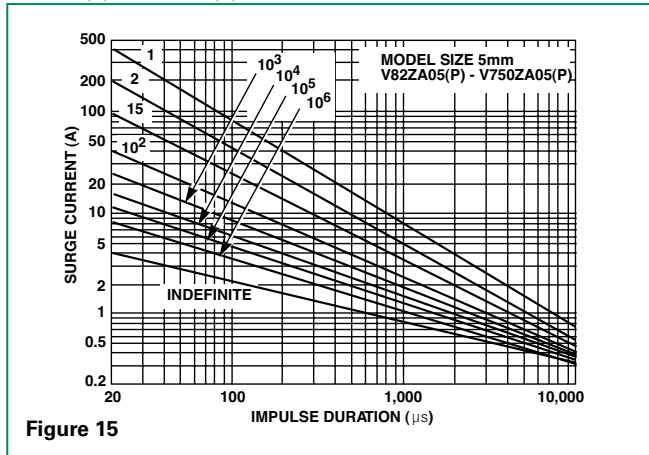

Figure 15

Repetitive Surge Capability for 7mm Parts

V8ZA1(P) - V12ZA1(P)

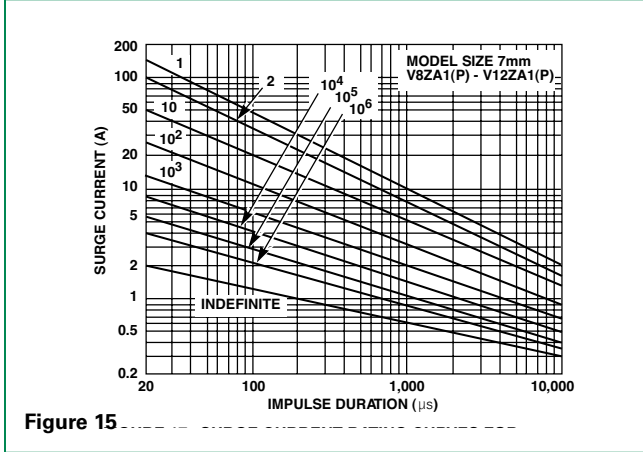

Figure 15

Repetitive Surge Capability for 10mm Parts

V8ZA2(P) - V12ZA2(P)

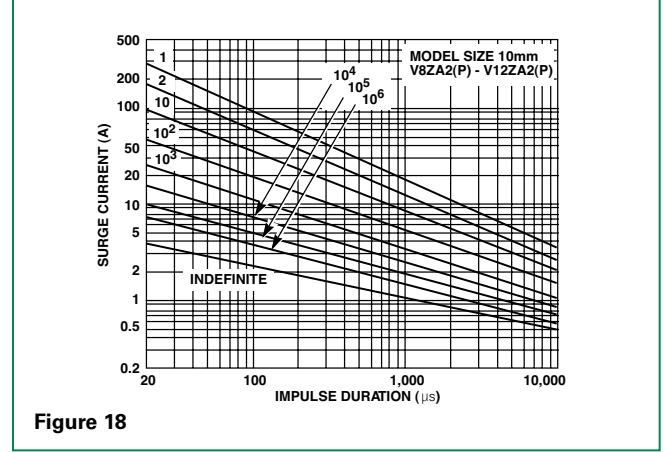

Figure 18

V18ZA1(P) - V68ZA2(P)

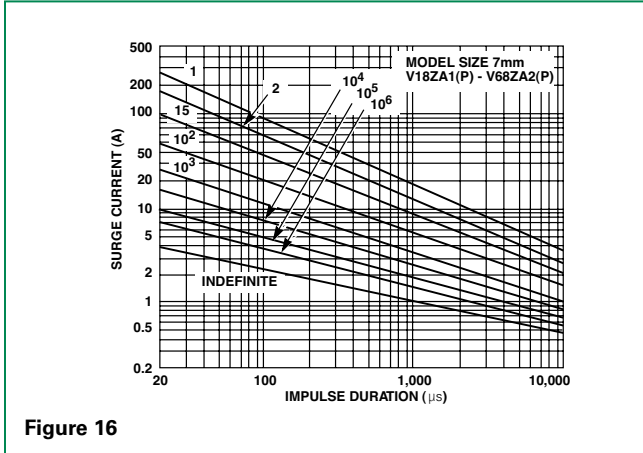

Figure 16

V18ZA2(P) - V68ZA3(P)

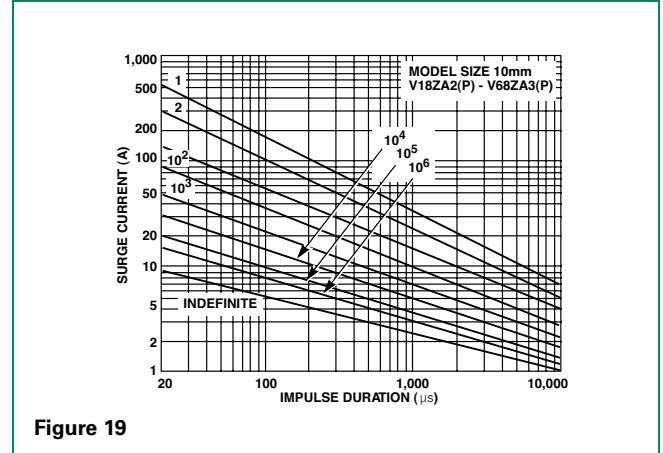

Figure 19

V82ZA2(P) - V180ZA1(P)

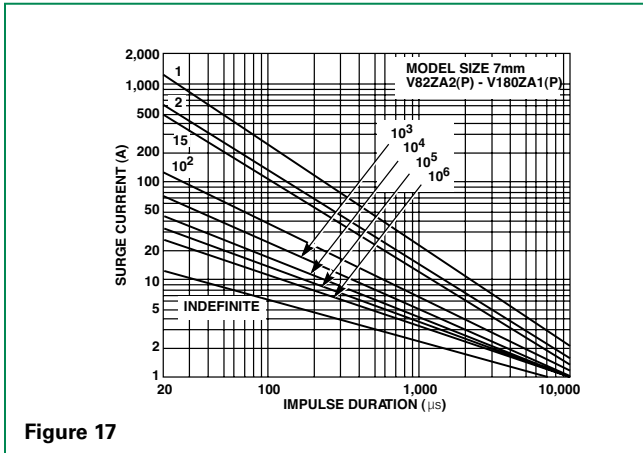

Figure 17

V82ZA4(P) - V180ZA5(P)

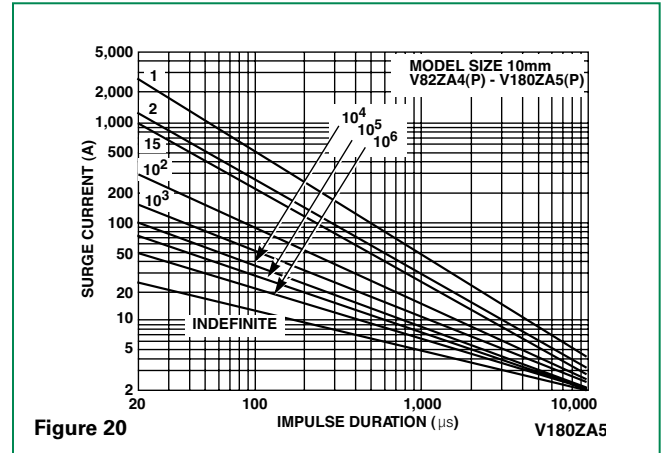
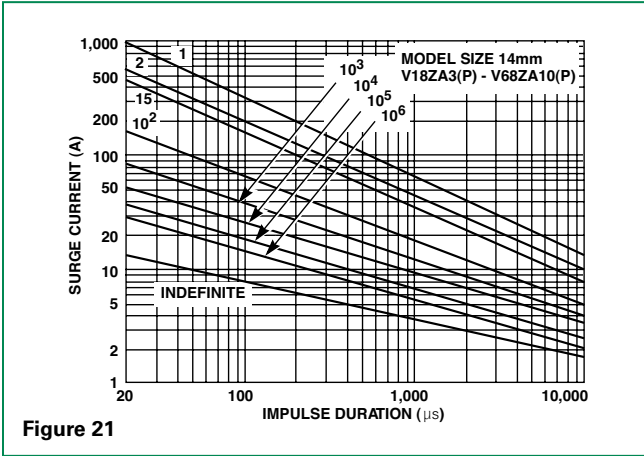

Figure 20

Repetitive Surge Capability for 14mm Parts

V18ZA3(P) - V68ZA10(P)



V82ZA12(P) - V180ZA10(P)

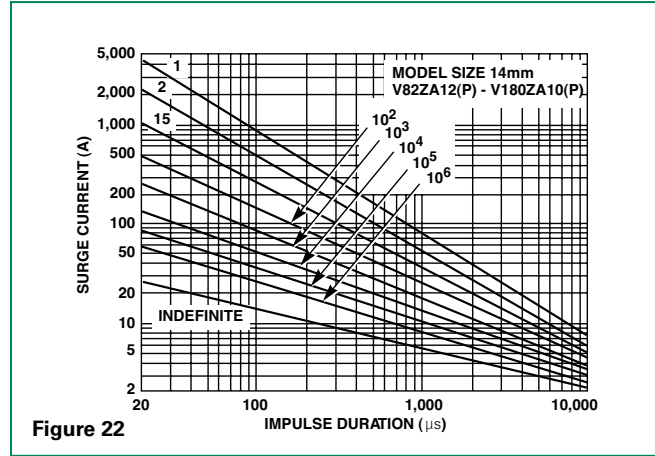

Repetitive Surge Capability for 20mm Parts

V18ZA40(P) - V68ZA20(P)

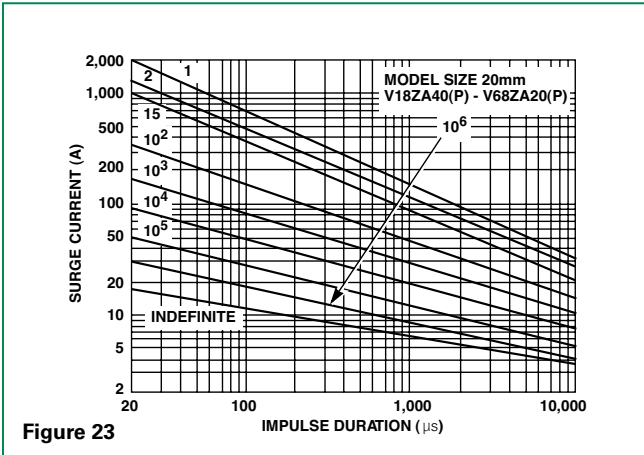

V82ZA20(P) - V180ZA20(P)

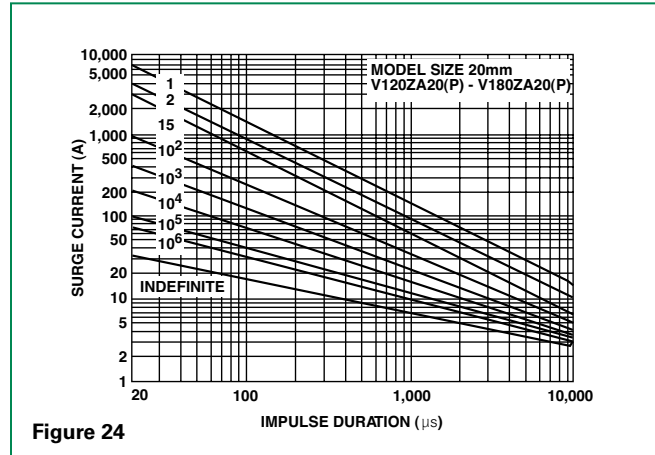

NOTE: If pulse ratings are exceeded, a shift of V_{NIDC} (at specified current) of more than +/-10% could result. This type of shift, which normally results in a decrease of V_{NIDC} , may result in the device not meeting the original published specifications, but does not prevent the device from continuing to function, and to provide ample protection.

Wave Solder Profile

Non Lead-free Profile

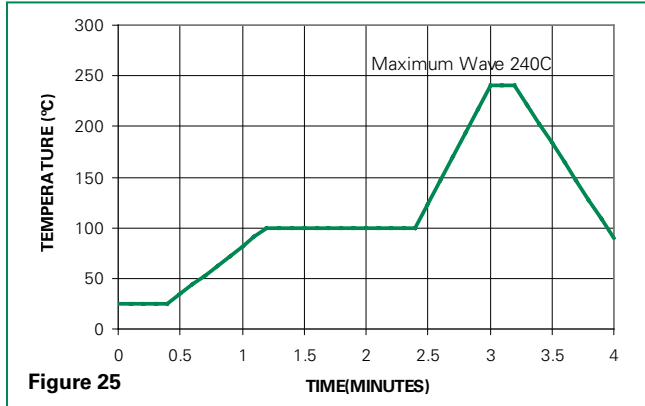

Lead-free Profile



Physical Specifications

Lead Material	Copper Clad Steel Wire
Soldering Characteristics	Solderability per MIL-STD-202, Method 208
Insulating Material	Cured, flame retardant epoxy polymer meets UL94V-0 requirements
Device Labeling	Marked with LF, voltage, UL/CSA logos, and date code

Environmental Specifications

Operating Ambient Temperature Range	-55°C to +85°C
Storage Temperature Range	-55°C to +125°C
Humidity Aging	+85°C, 85% RH, 1000 hours +/-10% typical voltage change
Thermal Shock	+85°C to -40°C 5 times +/-10% typical voltage change
Solvent Resistance	MIL-STD-202, Method 215
Moisture Sensitivity	Level 1, J-STD-020

Product Dimensions (mm)

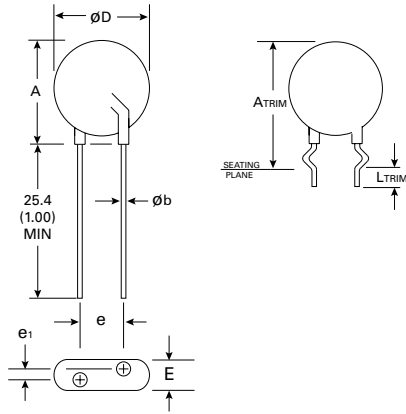

CRIMPED AND TRIMMED LEAD

Radial lead types can be supplied with combination preformed crimp and trimmed leads. This option is supplied to the dimensions shown.

*Seating plane interpretation per IEC-717

To order this crimped and trimmed lead style, standard radial type model numbers are changed by replacing the model letter "ZA" with "ZC." This option is supplied in bulk only.

Example:

Standard Model	Order As
V18ZA3P	V18ZC3P

For crimped leads without trimming and any variations to the above, contact Littelfuse.

Dimension	V _{RMS} Voltage Model	5mm Size		7mm Size		10mm Size		14mm Size		20mm Size	
		Min. mm (in)	Max. mm (in)	Min. mm (in)	Max. mm (in)	Min. mm (in)	Max. mm (in)	Min. mm (in)	Max. mm (in)	Min. mm (in)	Max. mm (in)
A	All	-	10 (0.394)	-	12 (0.472)	-	16 (0.630)	-	20 (0.787)	-	26.5 (1.043)
ØD	All	-	7 (0.276)	-	9 (0.354)	-	12.5 (0.492)	-	17 (0.669)	-	23 (0.906)
e (see notes below)	All	4 (0.157)	6 (0.236)	4 (0.157)	6 (0.236)	6.5 (0.256)	8.5 (0.335)	6.5 (0.256)	8.5 (0.335)	6.5 (0.256) (note 1 below)	8.5 (0.335) (note 1 below)
e₁	V8ZA-V56ZA	1 (0.039)	3 (0.118)	1 (0.039)	3 (0.118)	1 (0.039)	3 (0.118)	1 (0.039)	3 (0.118)	1 (0.039)	3 (0.118)
	V68ZA-V100ZA	1.5 (0.059)	3.5 (0.138)	1.5 (0.059)	3.5 (0.138)	1.5 (0.059)	3.5 (0.138)	1.5 (0.059)	3.5 (0.138)	1.5 (0.059)	3.5 (0.138)
	V120ZA-V180ZA	1 (0.039)	3 (0.118)	1 (0.039)	3 (0.118)	1 (0.039)	3 (0.118)	1 (0.038)	3 (0.118)	1 (0.038)	3 (0.118)
	V205ZA-V750ZA	1.5 (0.059)	3.5 (0.138)	-	-	-	-	-	-	-	-
E	V8ZA-V56ZA	-	5 (0.197)	-	5 (0.197)	-	5 (0.197)	-	5 (0.197)	-	5 (0.197)
	V68ZA-V100ZA	-	5.6 (0.220)	-	5.6 (0.220)	-	5.6 (0.220)	-	5.6 (0.220)	-	5.6 (0.220)
	V120ZA-V180ZA	-	5 (0.197)	-	5 (0.197)	-	5 (0.197)	-	5 (0.197)	-	5 (0.197)
	V205ZA-V750ZA	-	5.6 (0.220)	-	-	-	-	-	-	-	-
øb	All	0.585 (0.023)	0.685 (0.027)	0.585 (0.023)	0.685 (0.027)	0.76 (0.030)	0.86 (0.034)	0.76 (0.030)	0.86 (0.034)	0.76 (0.030)	0.86 (0.034)
A_{TRIM}	All	-	13.0 (0.512)	-	15 (0.591)	-	19.5 (0.768)	-	22.5 (0.886)	-	29.0 (1.142)
L_{TRIM}	All	2.41 (0.095)	4.69 (0.185)	2.41 (0.095)	4.69 (0.185)	2.41 (0.095)	4.69 (0.185)	2.41 (0.095)	4.69 (0.185)	2.41 (0.095)	4.69 (0.185)

NOTES: Dimensions in millimeters, inches in parentheses.

1. For 20mm size devices, a 10mm "e" dimension option is also available. Please refer to "Ordering Notes" section "X10" option code for additional information.

2. V24ZA50(P) and V24ZC50(P) only supplied with lead spacing of 6.35mm +/-0.5mm (0.25 +/-0.0196) Dimension e = 5.85 min. Does not apply to Tape and Reel parts.

Tape and Reel Specifications

5 and 7mm Devices

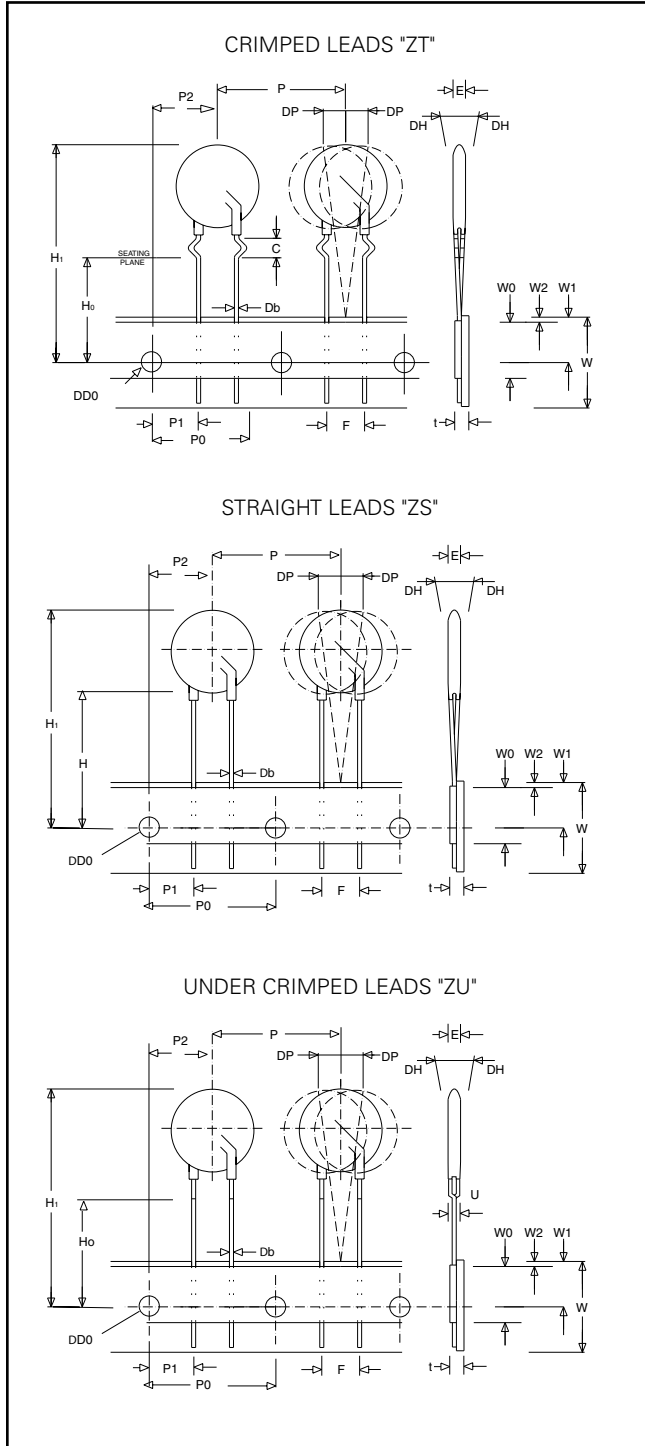

10, 14 and 20mm Devices

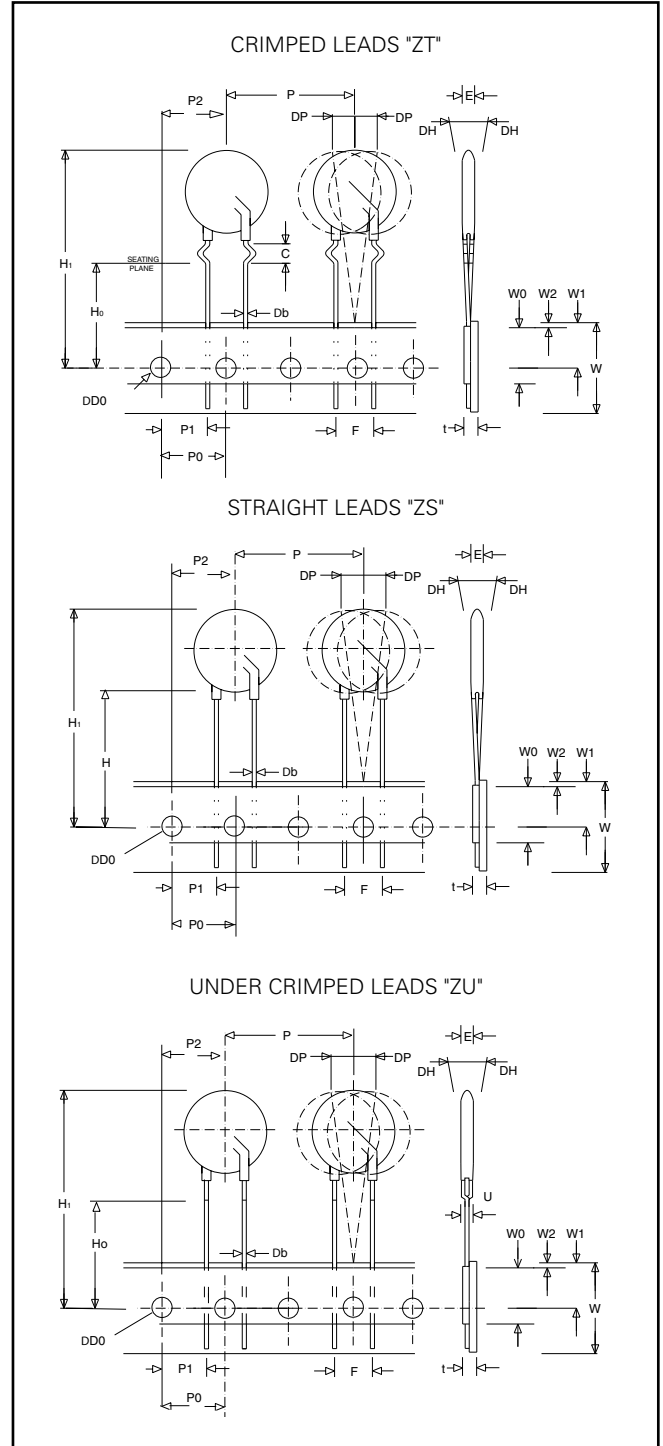

Refer to next page for dimension measurement specifics.

Tape and Reel Specifications (continued)

NOTES:

- Radial devices on tape are supplied with crimped leads, straight leads, or under-crimped leads
- Leads are offset by product dimension e1
- Conforms to ANSI and EIA specifications
- Can be supplied to IEC Publication 286-2
- 5mm parts are available on tape and reel up to 385 VAC only

SYMBOL	DESCRIPTION	MODEL SIZE				
		5mm	7mm	10mm	14mm	20mm
P	Pitch of Component	12.7 +/- 1.0	12.7 +/- 1.0	25.4 +/- 1.0	25.4 +/- 1.0	25.4 +/- 1.0
P₀	Feed Hole Pitch	12.7 +/- 0.2	12.7 +/- 0.2	12.7 +/- 0.2	12.7 +/- 0.2	12.7 +/- 0.2
P₁	Feed Hole Center to Pitch	3.85 +/- 0.7	3.85 +/- 0.7	8.85 +/- 0.7	8.85 +/- 0.7	8.85 +/- 0.7
P₂	Hole Center to Component Center	6.35 +/- 1.0	6.35 +/- 1.0	12.7 +/- 0.7	12.7 +/- 0.7	12.7 +/- 0.7
F	Lead to Lead Distance	5.0 +/- 1.0	5.0 +/- 1.0	7.5 +/- 1.0	7.5 +/- 1.0	7.5 +/- 1.0
h	Component Alignment	2.0 Max	2.0 Max	2.0 Max	2.0 Max	2.0 Max
W	Tape Width	18.0 +1.0 / -0.5	18.0 +1.0 / -0.5	18.0 +1.0 / -0.5	18.0 +1.0 / -0.5	18.0 +1.0 / -0.5
W₀	Hold Down Tape Width	12.0 +/- 0.3	12.0 +/- 0.3	12.0 +/- 0.3	12.0 +/- 0.3	12.0 +/- 0.3
W₁	Hole Position	9.0 +0.75 / -0.50	9.0 +0.75 / -0.50	9.0 +0.75 / -0.50	9.0 +0.75 / -0.50	9.0 +0.75 / -0.50
W₂	Hold Down Tape Position	0.5 Max	0.5 Max	0.5 Max	0.5 Max	0.5 Max
H	Height from Tape Center to Component Base	18.0 +2.0 / -0.0	18.0 +2.0 / -0.0	18.0 +2.0 / -0.0	18.0 +2.0 / -0.0	18.0 +2.0 / -0.0
H₀	Seating Plane Height	16.0 +/- 0.5	16.0 +/- 0.5	16.0 +/- 0.5	16.0 +/- 0.5	16.0 +/- 0.5
H₁	Component Height	29.0 Max	32.0 Max	36.0 Max	40.0 Max	46.5 Max
D₀	Feed Hole Diameter	4.0 +/- 0.2	4.0 +/- 0.2	4.0 +/- 0.2	4.0 +/- 0.2	4.0 +/- 0.2
t	Total Tape Thickness	0.7 +/- 0.2	0.7 +/- 0.2	0.7 +/- 0.2	0.7 +/- 0.2	0.7 +/- 0.2
U	Undercrimp Width	8.0 Max	8.0 Max	8.0 Max	8.0 Max	8.0 Max
p	Component Alignment	3° Max	3° Max	3° Max	3° Max	3° Max

Disclaimer Notice - Information furnished is believed to be accurate and reliable. However, users should independently evaluate the suitability of and test each product selected for their own applications. Littelfuse products are not designed for, and may not be used in, all applications. Read complete Disclaimer Notice at www.littelfuse.com/disclaimer-electronics.

Part Numbering System

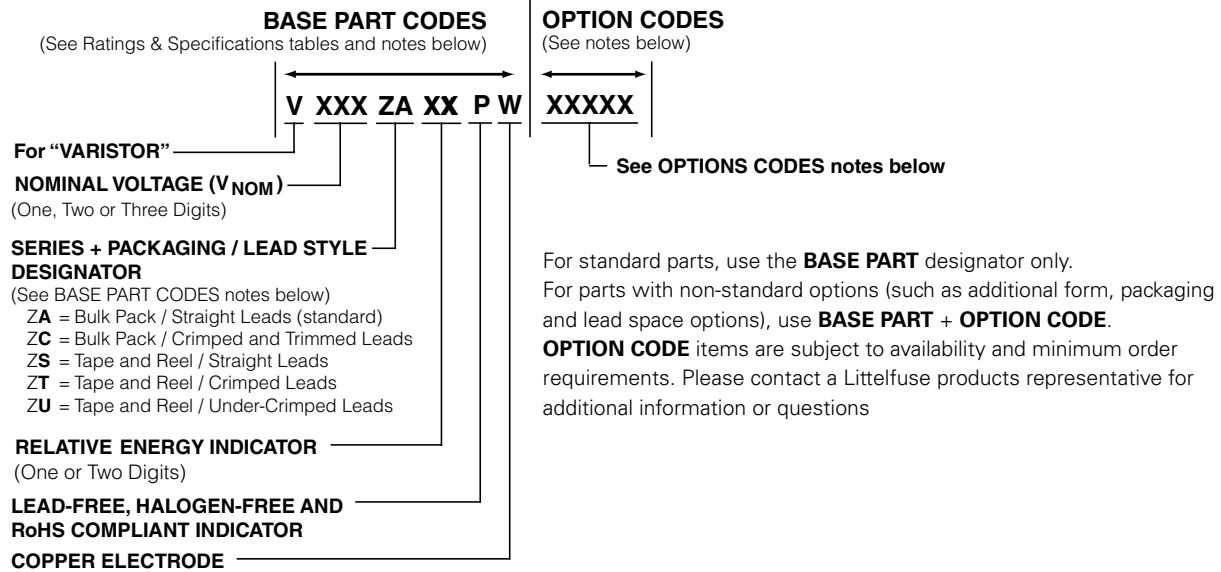

Ordering Notes:

BASE PART CODES:

Series + Packaging / Lead Style Designators:

Ordering examples:

Straight Lead Bulk Pack (standard)	Straight Lead Tape & Reel	Crimped Lead Tape & Reel	Crimped & Trimmed Lead Bulk Pack	Under-Crimp Lead Tape & Reel
V18 ZA 3P	V18 ZS 3P	V18 ZT 3P	V18 ZC 3P	V18 ZU 3P

Crimped lead ZA Series varistors are supplied standard in tape and reel, denoted with "ZT."

"ZC" style is supplied in bulk only.

"ZU" style is supplied in tape and reel only.

For crimped leads without trimming and any variations other than that described above, please contact Littelfuse.

Packaging and Quantities:

Littelfuse ZA Series varistors are shipped standard in bulk pack with straight leads and lead spacing outlined in the Package Dimensions section of this data sheet. Contact your Littelfuse sales representative to discuss non-standard options.

Tape & Reel Quantities:

Device Size	Voltage	Quantity Per Reel		
		"S" Reel	"T" Reel	"U" Reel
5mm	All	1000	1000	1000
7mm	All	1000	1000	1000
10mm	All	500	500	500
14mm	< 300V	500	500	500
20mm	< 300V	500	500	400

OPTION CODES:

X10: 10MM LEAD SPACING OPTION –

For 10 +/-1 mm (0.394 +/-0.039 in) lead spacing (available on 20mm diameter models only), append standard model BASE PART number with "X10." Example:

Standard Model	Order As
V18ZA40P	V18ZA40P X10

X2855: Nickel Barrier COATED WIRE OPTION –

All standard parts use tinned copper clad steel wire. Nickel Barrier Coated wire is available as an option, consisting of Copper wire with a flashing of Nickel followed by a top coating of Tin. To order append standard model BASE PART number with "X2855." Example:

Standard Model	Order As
V18ZA40P	V18ZA40P X2855

X1347: Hi-Temperature phenolic coating option –

Phenolic Coated C-III Series devices are available with improved maximum operating maximum temperature of 125°C.

To order, add X1347 to end of part number (Example: V22ZA3PX1347).

For additional information please refer to the section labeled "Phenolic Coating Option" within this document.

AUMOV® Varistor Series

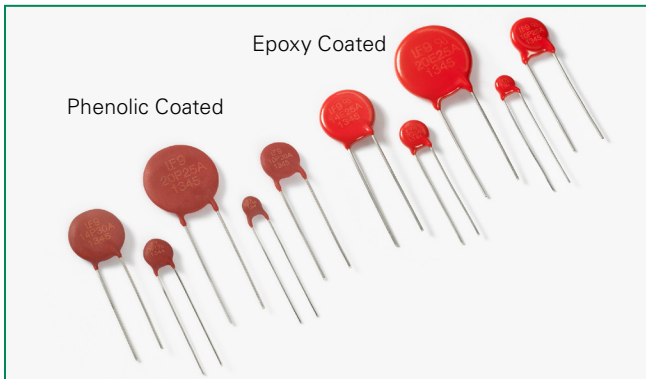

Description

The Littelfuse AUMOV® Varistor Series of low voltage, high surge current, radial leaded varistors provides an ideal circuit protection for load dump, jump start voltage transient conditions specifically for automotive applications.

The maximum peak surge current rating is rated up to 5kA (8/20 μ s pulse) to protect sensitive infotainment systems from voltage transients. This AEC-Q200 (Table 10) qualified series is available in five disc sizes: 5mm, 7mm, 10mm, 14mm and 20mm; it features a wide VDC voltage range from 16V to 825V.

Features

- Breakthrough in low voltage varistor design provides high peak surge current rating
- Phenolic and Silicone coating meet the stringent quality requirements of AEC-Q200 (Table 10)
- Reduced footprint and volume required for surge protection
- Optional phenolic coating for higher operating temperature up to 125°C
- High peak surge current rating up to 5kA (8/20 μ s pulse)
- Wide operating voltage range: 14VAC to 625VAC and 16VDC to 825VDC
- Five disc sizes available: 5, 7, 10, 14, and 20mm
- High resistance to thermal cycles for phenolic coating
- High energy absorption particularly for automotive load dump and jump start
- Lead-free, Halogen-Free and RoHS compliant
- Silicone coating option: High operating temperature combined with high isolation voltage capability: 125°C and 2500V, respectively

Agency Approvals

Agency	Agency File Number
	E320116 (only 14VAC to 42VAC for Epoxy coated)

Note: All Phenolic coating parts and Silicone coating parts are qualified to AEC-Q200 (Table 10).

Additional Information



Datasheet



Resources



Samples

Applications

- Body Electronics Systems
- Powertrain Systems
- Infotainment Systems
- Automotive Control Module Protection
- Motor or inductive load transient suppression

Absolute Maximum Ratings

• For ratings of individual members of a series, see Device Ratings and Specifications chart

	Low Voltage Series	Units
Continuous:		
Steady State Applied Voltage:		
AC Voltage Range ($V_{M(AC)RMS}$)	14 to 625	V
DC Voltage Range ($V_{M(DC)}$)	16 to 825	V
Transient:		
Non-Repetitive Surge Current, 8/20 μ s Waveform (I_{TM})	400 to 5,000	A
Non-Repetitive Energy Capability, 2ms Waveform (W_{TM})	1.0 to 140	J
Operating Ambient Temperature Range (T_A) for Epoxy coated	-40 to +85	°C
Operating Ambient Temperature Range (T_A) for Phenolic coated and Silicone coated	-40 to +125	°C
Storage Temperature Range (T_{STG}) for Epoxy coated	-40 to +125	°C
Storage Temperature Range (T_{STG}) for Phenolic coated and Silicone coated	-40 to +150	°C
Temperature Coefficient (α_V) of Clamping Voltage (V_C) at Specified Test Current	< 0.01 %	°C
Hi-Pot Encapsulation (Isolation Voltage Capability) for Epoxy coated	2500	V
Hi-Pot Encapsulation (Isolation Voltage Capability) for Phenolic coated	500	V
Hi-Pot Encapsulation (Isolation Voltage Capability) for Silicone coated	2500	V
Temperature Cycling (-40C to +125C) for Epoxy coated	5	Cycles
Temperature Cycling (-40C to +125C) for Phenolic and Silicone coated	1000	Cycles

CAUTION: Stresses above those listed in "Absolute Maximum Ratings" may cause permanent damage to the device. This is a stress only rating and operation of the device at these or any other conditions above those indicated in the operational sections of this specification is not implied.

AUMOV[®] Varistor Series Device Ratings & Specifications

Epoxy Coated Models		Phenolic Coated Models		Size Disc Dia. (mm)	Max Continuous Voltage		Varistor Voltage at 1mA			Maximum Clamping Voltage		Max Peak Current (8 x 20 μ s 1 pulse)	Energy Rating (2ms, 1 pulse)	Energy (Load Dump, 10 pulses)*	Jump Start DC V _{Jump} (5 min)	Typical Capacitance f = 1MHz		
Part Number (Base part)	Branding	Part Number (Base part)	Branding		V _{RMS}	V _{DC}	Min	Nom	Max	V _C	I _{PK}						I _{TM}	W _{TM}
					(V)	(V)	(V)	(V)	(V)	(V)	(A)						(A)	(J)
V05E14AUTO	5E14A	V05P14AUTO	5P14A	5	14	16	19.8	22	24.2	43	1	400	1	6	25	1100		
V07E14AUTO	7E14A	V07P14AUTO	7P14A	7	14	16	19.8	22	24.2	43	2.5	800	2.2	12	25	2450		
V10E14AUTO	10E14A	V10P14AUTO	10P14A	10	14	16	19.8	22	24.2	43	5	1500	5	25	25	4650		
V14E14AUTO	14E14A	V14P14AUTO	14P14A	14	14	16	19.8	22	24.2	43	10	3000	10	50	25	10200		
V20E14AUTO	20E14A	V20P14AUTO	20P14A	20	14	16	19.8	22	24.2	43	20	5000	28	100	25	22200		
V05E17AUTO	5E17A	V05P17AUTO	5P17A	5	17	20	24.3	27	29.7	53	1	400	1.4	6	30	950		
V07E17AUTO	7E17A	V07P17AUTO	7P17A	7	17	20	24.3	27	29.7	53	2.5	800	2.8	12	30	2100		
V10E17AUTO	10E17A	V10P17AUTO	10P17A	10	17	20	24.3	27	29.7	53	5	1500	6.5	25	30	3900		
V14E17AUTO	14E17A	V14P17AUTO	14P17A	14	17	20	24.3	27	29.7	53	10	3000	13	50	30	8700		
V20E17AUTO	20E17A	V20P17AUTO	20P17A	20	17	20	24.3	27	29.7	53	20	5000	35	100	30	18750		
V05E20AUTO	5E20A	V05P20AUTO	5P20A	5	20	26	29.7	33	36.3	65	1	400	2	6	35	790		
V07E20AUTO	7E20A	V07P20AUTO	7P20A	7	20	26	29.7	33	36.3	65	2.5	800	4.2	12	35	1620		
V10E20AUTO	10E20A	V10P20AUTO	10P20A	10	20	26	29.7	33	36.3	65	5	1500	10	25	35	3495		
V14E20AUTO	14E20A	V14P20AUTO	14P20A	14	20	26	29.7	33	36.3	65	10	3000	20	50	35	9290		
V20E20AUTO	20E20A	V20P20AUTO	20P20A	20	20	26	29.7	33	36.3	65	20	5000	58	100	35	13000		
V05E23AUTO	5E23A	V05P23AUTO	5P23A	5	23	28	32.4	36	39.6	71	1	400	2.2	6	38	720		
V07E23AUTO	7E23A	V07P23AUTO	7P23A	7	23	28	32.4	36	39.6	71	2.5	800	5	12	38	1500		
V10E23AUTO	10E23A	V10P23AUTO	10P23A	10	23	28	32.4	36	39.6	71	5	1500	12	25	38	3300		
V14E23AUTO	14E23A	V14P23AUTO	14P23A	14	23	28	32.4	36	39.6	71	10	3000	23	50	38	8000		
V20E23AUTO	20E23A	V20P23AUTO	20P23A	20	23	28	32.4	36	39.6	71	20	5000	70	100	38	12500		
V05E25AUTO	5E25A	V05P25AUTO	5P25A	5	25	28	35.1	39	42.9	77	1	400	2.5	6	40	750		
V07E25AUTO	7E25A	V07P25AUTO	7P25A	7	25	28	35.1	39	42.9	77	2.5	800	5.5	12	40	1500		
V10E25AUTO	10E25A	V10P25AUTO	10P25A	10	25	28	35.1	39	42.9	77	5	1500	13	25	40	2900		
V14E25AUTO	14E25A	V14P25AUTO	14P25A	14	25	28	35.1	39	42.9	77	10	3000	25	50	40	6200		
V20E25AUTO	20E25A	V20P25AUTO	20P25A	20	25	28	35.1	39	42.9	77	20	5000	77	100	40	13500		
V05E30AUTO	5E30A	V05P30AUTO	5P30A	5	30	34	42.3	47	51.7	93	1	400	3.1	6	45	650		
V07E30AUTO	7E30A	V07P30AUTO	7P30A	7	30	34	42.3	47	51.7	93	2.5	800	7	12	45	1350		
V10E30AUTO	10E30A	V10P30AUTO	10P30A	10	30	34	42.3	47	51.7	93	5	1500	15.5	25	45	2550		
V14E30AUTO	14E30A	V14P30AUTO	14P30A	14	30	34	42.3	47	51.7	93	10	3000	32	50	45	5550		
V20E30AUTO	20E30A	V20P30AUTO	20P30A	20	30	34	42.3	47	51.7	93	20	5000	90	100	45	12000		
V05E35AUTO	5E35A	V05P35AUTO	5P35A	5	35	45	50.4	56	61.6	110	1	400	4	6	50	500		
V07E35AUTO	7E35A	V07P35AUTO	7P35A	7	35	45	50.4	56	61.6	110	2.5	800	9	12	50	1100		
V10E35AUTO	10E35A	V10P35AUTO	10P35A	10	35	45	50.4	56	61.6	110	5	1500	20	25	50	2100		
V14E35AUTO	14E35A	V14P35AUTO	14P35A	14	35	45	50.4	56	61.6	110	10	3000	40	50	50	5000		
V20E35AUTO	20E35A	V20P35AUTO	20P35A	20	35	45	50.4	56	61.6	110	20	5000	115	100	50	10000		
V05E42AUTO	5E42A	V05P42AUTO	5P42A	5	42	50	61.2	68	74.8	135	1	400	5	6	55	500		
V07E42AUTO	7E42A	V07P42AUTO	7P42A	7	42	50	61.2	68	74.8	135	2.5	800	11	12	55	1000		
V10E42AUTO	10E42A	V10P42AUTO	10P42A	10	42	50	61.2	68	74.8	135	5	1500	25	25	55	1850		
V14E42AUTO	14E42A	V14P42AUTO	14P42A	14	42	50	61.2	68	74.8	135	10	3000	50	50	55	4000		
V20E42AUTO	20E42A	V20P42AUTO	20P42A	20	42	50	61.2	68	74.8	135	20	5000	140	100	55	8500		
V05E50AUTO	5E50A	V05P50AUTO	5P50A	5	50	65	73.8	82	90.2	135	5	400	2	-	-	350		
V07E50AUTO	7E50A	V07P50AUTO	7P50A	7	50	65	73.8	82	90.2	135	10	1200	4	-	-	800		
V10E50AUTO	10E50A	V10P50AUTO	10P50A	10	50	65	73.8	82	90.2	135	25	2500	8	-	-	1400		
V14E50AUTO	14E50A	V14P50AUTO	14P50A	14	50	65	73.8	82	90.2	145	50	4500	15	-	-	3000		
V20E50AUTO	20E50A	V20P50AUTO	20P50A	20	50	65	73.8	82	90.2	145	100	6500	25	-	-	6000		
V05E60AUTO	5E60A	V05P60AUTO	5P60A	5	60	85	90	100	110	165	5	400	2.5	-	-	310		
V07E60AUTO	7E60A	V07P60AUTO	7P60A	7	60	85	90	100	110	165	10	1200	5	-	-	700		
V10E60AUTO	10E60A	V10P60AUTO	10P60A	10	60	85	90	100	110	165	25	2500	10	-	-	1200		
V14E60AUTO	14E60A	V14P60AUTO	14P60A	14	60	85	90	100	110	175	50	4500	20	-	-	2500		
V20E60AUTO	20E60A	V20P60AUTO	20P60A	20	60	85	90	100	110	175	100	6500	30	-	-	5200		

AUMOV® Varistor Series Device Ratings & Specifications cont...

Epoxy Coated Models		Phenolic Coated Models		Size Disc Dia. (mm)	Max Continuous Voltage		Varistor Voltage at 1mA			Maximum Clamping Voltage		Max Peak Current (8 x 20µs 1 pulse)	Energy Rating (2ms, 1 pulse)	Energy (Load Dump, 10 pulses)*	Jump Start DC V _{JUMP} (5 min)	Typical Capacitance f = 1MHz
Part Number (Base part)	Branding	Part Number (Base part)	Branding		V _{RMS}	V _{DC}	Min	Nom	Max	V _C	I _{PK}					
					(V)	(V)	(V)	(V)	(V)	(V)	(A)	(A)	(J)	(J)	(V)	(pF)
V05E75AUTO	5E75A	V05P75AUTO	5P75A	5	75	100	108	120	132	205	5	400	3	-	-	260
V07E75AUTO	7E75A	V07P75AUTO	7P75A	7	75	100	108	120	132	205	10	1200	6	-	-	600
V10E75AUTO	10E75A	V10P75AUTO	10P75A	10	75	100	108	120	132	200	25	2500	12	-	-	1100
V14E75AUTO	14E75A	V14P75AUTO	14P75A	14	75	100	108	120	132	210	50	4500	22	-	-	2300
V20E75AUTO	20E75A	V20P75AUTO	20P75A	20	75	100	108	120	132	210	100	6500	33	-	-	4800
V05E95AUTO	5E95A	V05P95AUTO	5P95A	5	95	125	135	150	165	250	5	400	4	-	-	200
V07E95AUTO	7E95A	V07P95AUTO	7P95A	7	95	125	135	150	165	250	10	1200	8	-	-	520
V10E95AUTO	10E95A	V10P95AUTO	10P95A	10	95	125	135	150	165	250	25	2500	15	-	-	800
V14E95AUTO	14E95A	V14P95AUTO	14P95A	14	95	125	135	150	165	250	50	4500	22	-	-	1700
V20E95AUTO	20E95A	V20P95AUTO	20P95A	20	95	125	135	150	165	250	100	6500	45	-	-	3700
V10E130AUTO	10E130A	V10P130AUTO	10P130A	10	130	170	184.5	205	225.5	340	25	3500	40	-	-	450
V14E130AUTO	14E130A	V14P130AUTO	14P130A	14	130	170	184.5	205	225.5	340	50	6500	60	-	-	1000
V20E130AUTO	20E130A	V20P130AUTO	20P130A	20	130	170	184.5	205	225.5	340	100	10000	145	-	-	1900
V10E140AUTO	10E140A	V10P140AUTO	10P140A	10	140	180	198	220	242	360	25	3500	45	-	-	400
V14E140AUTO	14E140A	V14P140AUTO	14P140A	14	140	180	198	220	242	360	50	6500	65	-	-	900
V20E140AUTO	20E140A	V20P140AUTO	20P140A	20	140	180	198	220	242	360	100	10000	155	-	-	1750
V10E150AUTO	10E150A	V10P150AUTO	10P150A	10	150	200	216	240	264	395	25	3500	50	-	-	360
V14E150AUTO	14E150A	V14P150AUTO	14P150A	14	150	200	216	240	264	395	50	6500	70	-	-	800
V20E150AUTO	20E150A	V20P150AUTO	20P150A	20	150	200	216	240	264	395	100	10000	165	-	-	1600
V10E175AUTO	10E175A	V10P175AUTO	10P175A	10	175	225	243	270	297	455	25	3500	55	-	-	350
V14E175AUTO	14E175A	V14P175AUTO	14P175A	14	175	225	243	270	297	455	50	6500	80	-	-	700
V20E175AUTO	20E175A	V20P175AUTO	20P175A	20	175	225	243	270	297	455	100	10000	180	-	-	1400
V10E230AUTO	10E230A	V10P230AUTO	10P230A	10	230	300	324	360	396	595	25	3500	60	-	-	250
V14E230AUTO	14E230A	V14P230AUTO	14P230A	14	230	300	324	360	396	595	50	6500	105	-	-	550
V20E230AUTO	20E230A	V20P230AUTO	20P230A	20	230	300	324	360	396	595	100	10000	225	-	-	1100
V10E250AUTO	10E250A	V10P250AUTO	10P250A	10	250	320	351	390	429	650	25	3500	65	-	-	220
V14E250AUTO	14E250A	V14P250AUTO	14P250A	14	250	320	351	390	429	650	50	6500	115	-	-	500
V20E250AUTO	20E250A	V20P250AUTO	20P250A	20	250	320	351	390	429	650	100	10000	240	-	-	1000
V10E275AUTO	10E275A	V10P275AUTO	10P275A	10	275	350	387	430	473	710	25	3500	70	-	-	200
V14E275AUTO	14E275A	V14P275AUTO	14P275A	14	275	350	387	430	473	710	50	6500	130	-	-	450
V20E275AUTO	20E275A	V20P275AUTO	20P275A	20	275	350	387	430	473	710	100	10000	260	-	-	900
V10E300AUTO	10E300A	V10P300AUTO	10P300A	10	300	385	423	470	517	775	25	3500	75	-	-	180
V14E300AUTO	14E300A	V14P300AUTO	14P300A	14	300	385	423	470	517	775	50	6500	140	-	-	400
V20E300AUTO	20E300A	V20P300AUTO	20P300A	20	300	385	423	470	517	775	100	10000	290	-	-	800
V10E320AUTO	10E320A	V10P320AUTO	10P320A	10	320	420	459	510	561	840	25	3500	80	-	-	170
V14E320AUTO	14E320A	V14P320AUTO	14P320A	14	320	420	459	510	561	840	50	6500	150	-	-	380
V20E320AUTO	20E320A	V20P320AUTO	20P320A	20	320	420	459	510	561	840	100	10000	320	-	-	750
V10E385AUTO	10E385A	V10P385AUTO	10P385A	10	385	505	558	620	682	1025	25	3500	85	-	-	160
V14E385AUTO	14E385A	V14P385AUTO	14P385A	14	385	505	558	620	682	1025	50	6500	175	-	-	360
V20E385AUTO	20E385A	V20P385AUTO	20P385A	20	385	505	558	620	682	1025	100	10000	325	-	-	700
V10E420AUTO	10E420A	V10P420AUTO	10P420A	10	420	560	612	680	748	1120	25	3500	90	-	-	140
V14E420AUTO	14E420A	V14P420AUTO	14P420A	14	420	560	612	680	748	1120	50	6500	185	-	-	300
V20E420AUTO	20E420A	V20P420AUTO	20P420A	20	420	560	612	680	748	1120	100	10000	330	-	-	600
V10E440AUTO	10E440A	V10P440AUTO	10P440A	10	440	585	643.5	715	786.5	1180	25	3500	95	-	-	130
V14E440AUTO	14E440A	V14P440AUTO	14P440A	14	440	585	643.5	715	786.5	1180	50	6500	185	-	-	260
V20E440AUTO	20E440A	V20P440AUTO	20P440A	20	440	585	643.5	715	786.5	1180	100	10000	340	-	-	500
V10E460AUTO	10E460A	V10P460AUTO	10P460A	10	460	615	675	750	825	1240	25	3500	95	-	-	120
V14E460AUTO	14E460A	V14P460AUTO	14P460A	14	460	615	675	750	825	1240	50	6500	190	-	-	220
V20E460AUTO	20E460A	V20P460AUTO	20P460A	20	460	615	675	750	825	1240	100	10000	370	-	-	400
V10E510AUTO	10E510A	V10P510AUTO	10P510A	10	510	670	738	820	902	1355	25	3500	98	-	-	110
V14E510AUTO	14E510A	V14P510AUTO	14P510A	14	510	670	738	820	902	1355	50	6500	205	-	-	200
V20E510AUTO	20E510A	V20P510AUTO	20P510A	20	510	670	738	820	902	1355	100	10000	410	-	-	350

AUMOV® Varistor Series Device Ratings & Specifications cont...

Epoxy Coated Models		Phenolic Coated Models		Size Disc Dia. (mm)	Max Continuous Voltage		Varistor Voltage at 1mA			Maximum Clamping Voltage		Max Peak Current (8 x 20µs 1 pulse)	Energy Rating (2ms, 1 pulse)	Energy (Load Dump, 10 pulses)*	Jump Start DC V _{Jump} (5 min)	Typical Capacitance f = 1MHz
Part Number (Base part)	Branding	Part Number (Base part)	Branding		V _{RMS} (V)	V _{DC} (V)	Min (V)	Nom (V)	Max (V)	V _C (V)	I _{PK} (A)					
V10E550AUTO	10E550A	V10P550AUTO	10P550A	10	550	745	819	910	1001	1500	25	3500	98	-	-	100
V14E550AUTO	14E550A	V14P550AUTO	14P550A	14	550	745	819	910	1001	1500	50	6500	210	-	-	180
V20E550AUTO	20E550A	V20P550AUTO	20P550A	20	550	745	819	910	1001	1500	100	10000	450	-	-	300
V10E625AUTO	10E625A	V10P625AUTO	10P625A	10	625	825	900	1000	1100	1650	25	3500	110	-	-	90
V14E625AUTO	14E625A	V14P625AUTO	14P625A	14	625	825	900	1000	1100	1650	50	6500	235	-	-	160
V20E625AUTO	20E625A	V20P625AUTO	20P625A	20	625	825	900	1000	1100	1650	100	10000	490	-	-	250

Note: 1. Average power dissipation of transients not to exceed 0.2W, 0.25W, 0.4W, 0.6W or 1W for model sizes 5mm, 7mm, 10mm, 14mm and 20mm, respectively.
 *2. Energy rating (auto load dump) for impulse duration of 40ms minimum to one half of peak current, 60sec interval ISO7637-2 pulse 5a and ISO16750-2 Table 5A.
 3. The shift of V_{nom} (Varistor Voltage) may be to +/-15% for Load dump or Jump Start test.
 4. The ratings and specifications of Silicone coated options are the same as the Phenolic coating, except the isolation voltage capability (Hi-Pot Encapsulation) is 2500V.

Current Energy and Power Dissipation Ratings

Figure 1A - Power Derating for Epoxy Coated

For applications exceeding 85°C ambient temperature, the peak surge current and energy ratings must be reduced as shown below.

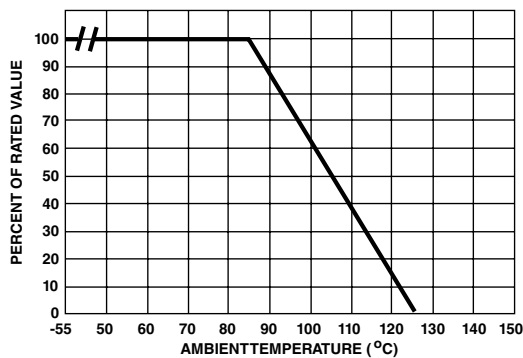
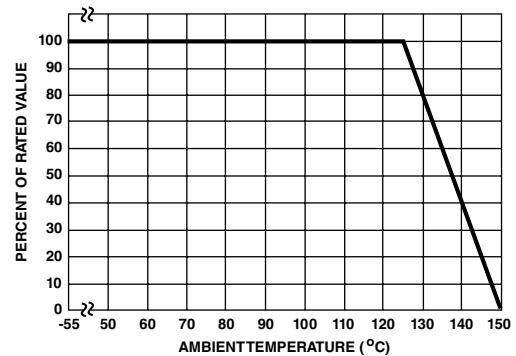
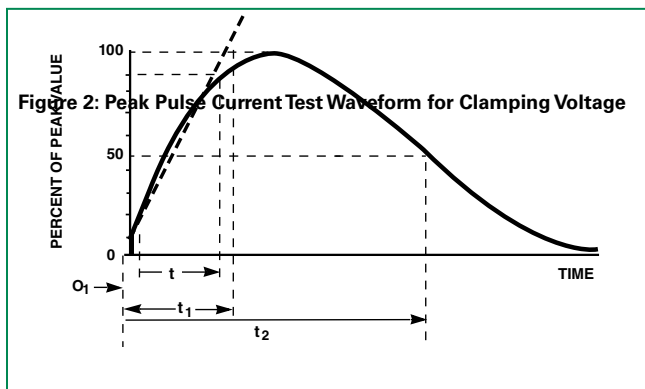

Figure 1B - Power Derating for Phenolic Coated and Silicone Coated

For applications exceeding 125°C ambient temperature, the peak surge current and energy ratings must be reduced as shown below.



Peak Pulse Current Test Waveform for Clamping Voltage



O₁ = Virtual Origin of Wave
 t = Time from 10% to 90% of Peak
 t₁ = Virtual Front Time = 1.25 x t
 t₂ = Virtual Time to Half-Value (Impulse Duration)

Example - For an 8/20 µs Current Waveform:

8µs = t₁ = Virtual Front Time
 20µs = t₂ = Virtual Time to Half-Value

Maximum Clamping Voltage for 5mm Parts

V05x14AUTO - V05x42AUTO

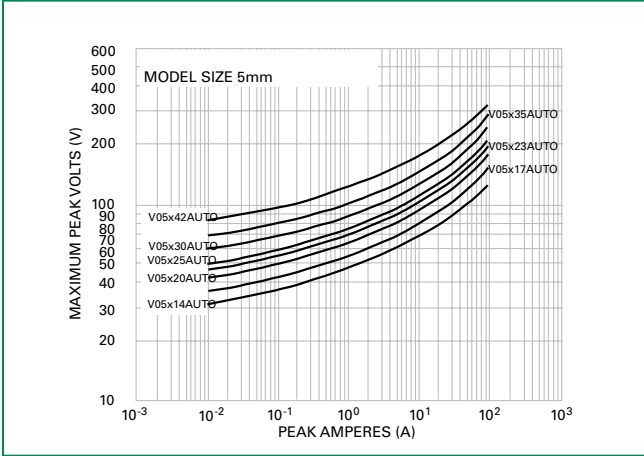

Maximum Clamping Voltage for 5mm Parts

V05x50AUTO - V05x95AUTO

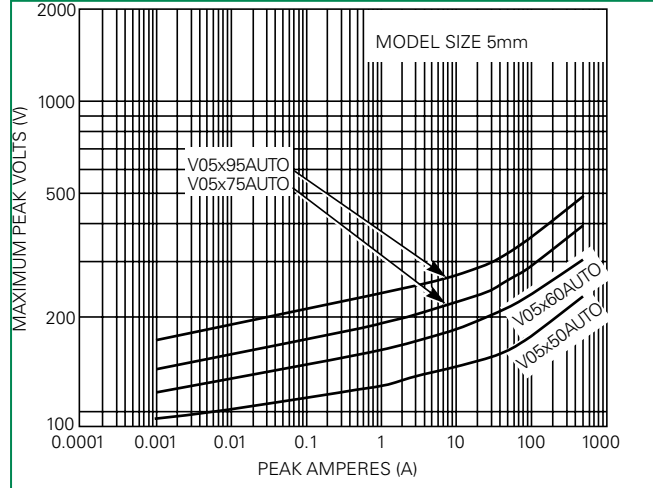

Maximum Clamping Voltage for 7mm Parts

V07x14AUTO - V07x42AUTO

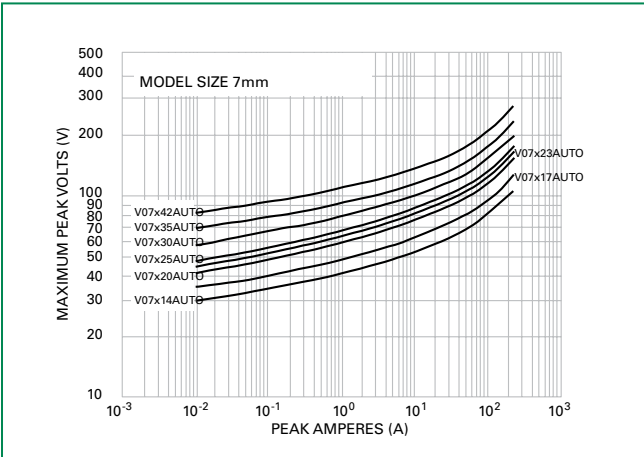

Maximum Clamping Voltage for 7mm Parts

V07x50AUTO - V07x95AUTO

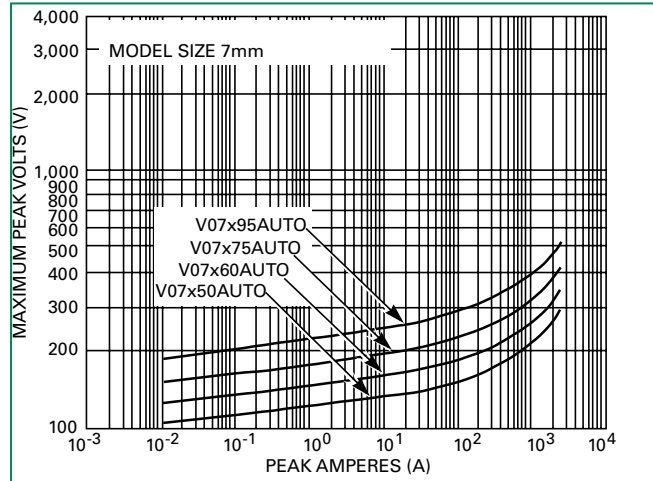

Maximum Clamping Voltage for 10mm Parts

V10x14AUTO - V10x42AUTO

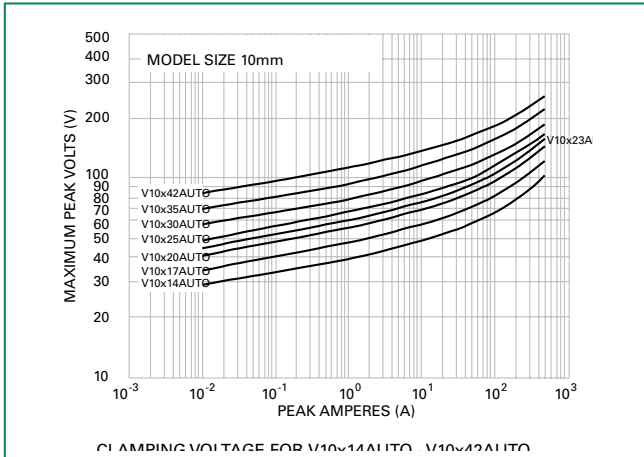

Maximum Clamping Voltage for 10mm Parts

V10x50AUTO - V10x95AUTO

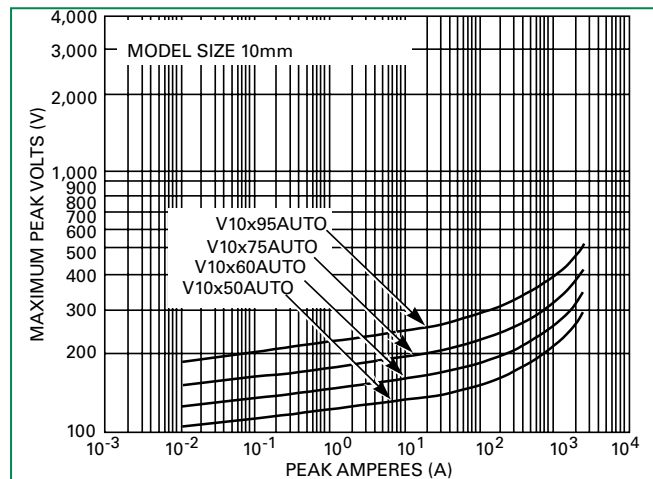

Maximum Clamping Voltage for 10mm Parts

V10x130AUTO - V10x625AUTO

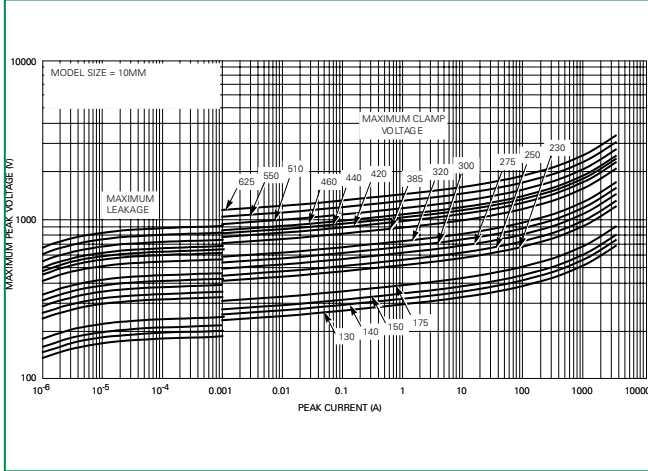

Maximum Clamping Voltage for 14mm Parts

V14x14AUTO - V14x42AUTO

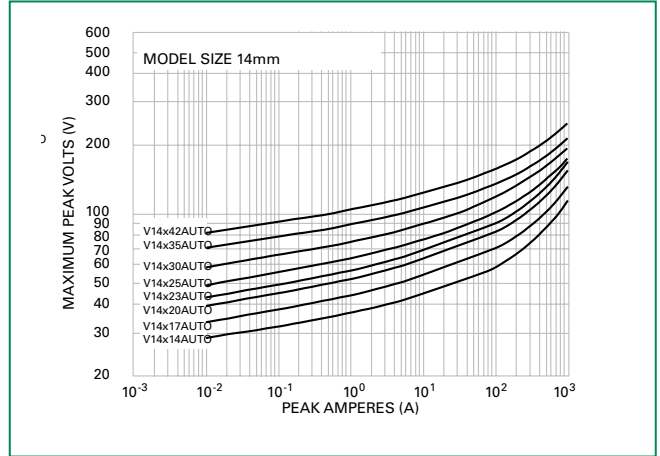

Maximum Clamping Voltage for 14mm Parts

V14x50AUTO - V14x95AUTO

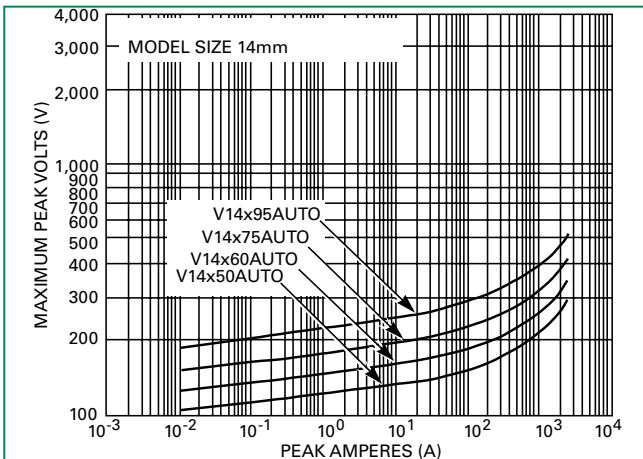

Maximum Clamping Voltage for 14mm Parts

V14x130AUTO - V14x625AUTO



Maximum Clamping Voltage for 20mm Parts

V20x14AUTO - V20x42AUTO

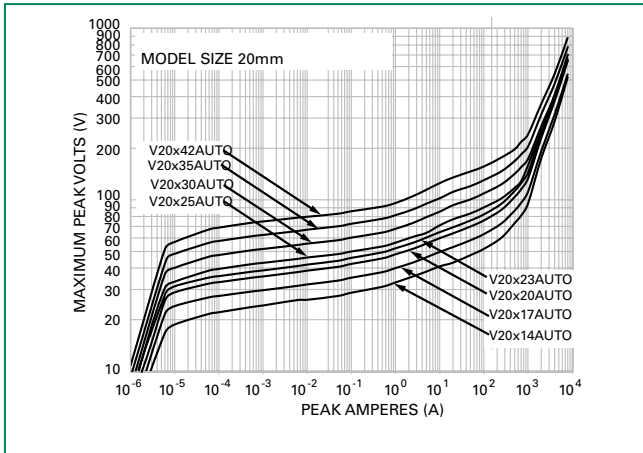

Maximum Clamping Voltage for 20mm Parts

V20x50AUTO - V20x95AUTO

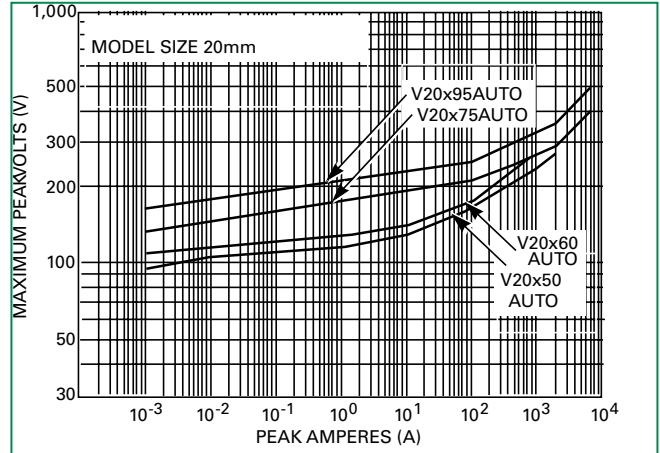

Maximum Clamping Voltage for 20mm Parts

V20x130AUTO - V20x625AUTO

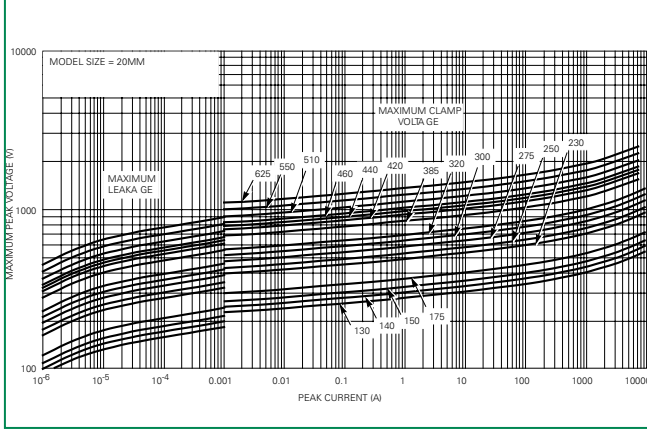

Repetitive Surge Capability for 5mm Parts

V05x14AUTO - V05x42AUTO

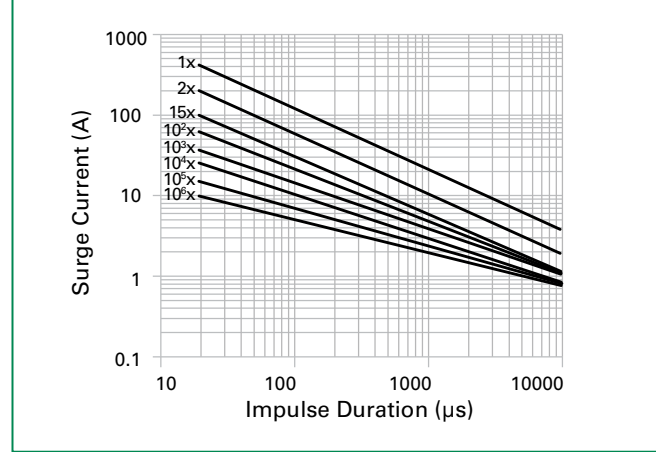

Repetitive Surge Capability for 5mm Parts

V05x50AUTO - V05x95AUTO

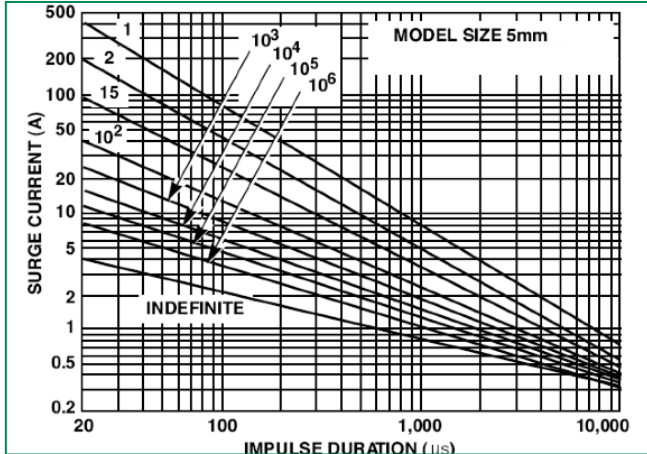

Repetitive Surge Capability for 7mm Parts

V07x14AUTO - V07x42AUTO

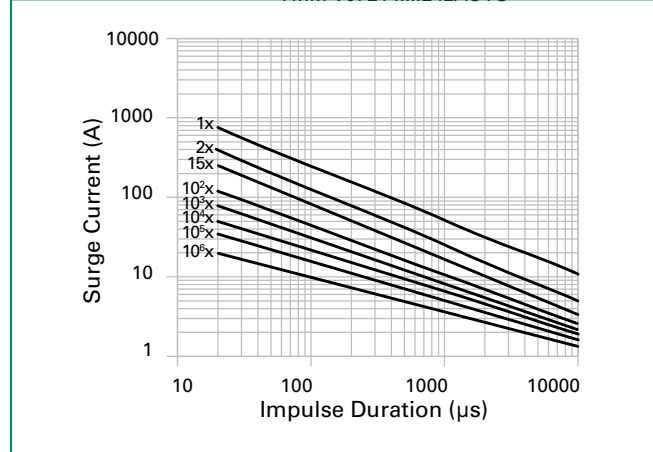

Repetitive Surge Capability for 7mm Parts

V07x50AUTO - V07x95AUTO

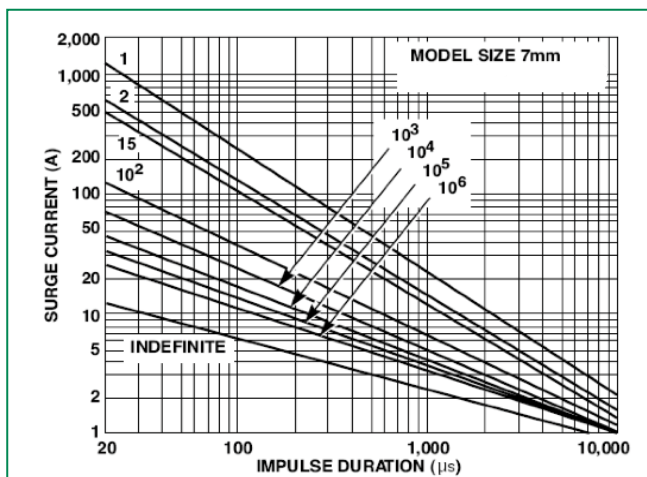

Repetitive Surge Capability for 10mm Parts

V10x14AUTO - V10x42AUTO

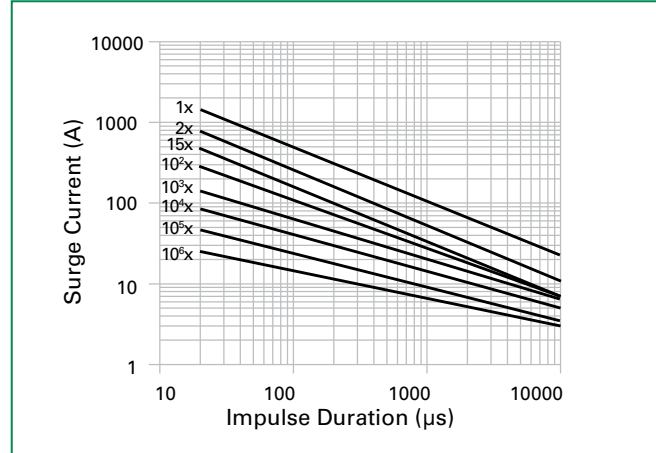

NOTE: If pulse ratings are exceeded, a shift of $V_{N(DC)}$ (at specified current) of more than +/-10% could result. This type of shift, which normally results in a decrease of $V_{N(DC)}$, may result in the device not meeting the original published specifications, but does not prevent the device from continuing to function, and to provide ample protection.

Repetitive Surge Capability for 10mm Parts

V10x50AUTO - V10x95AUTO

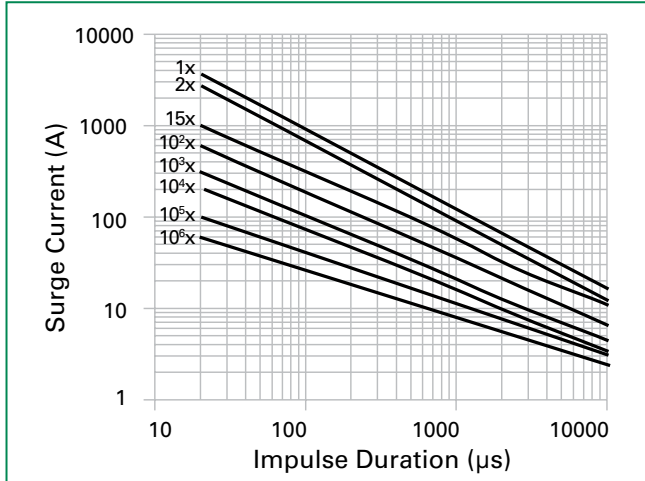

Repetitive Surge Capability for 10mm Parts

V10x130AUTO - V10x625AUTO

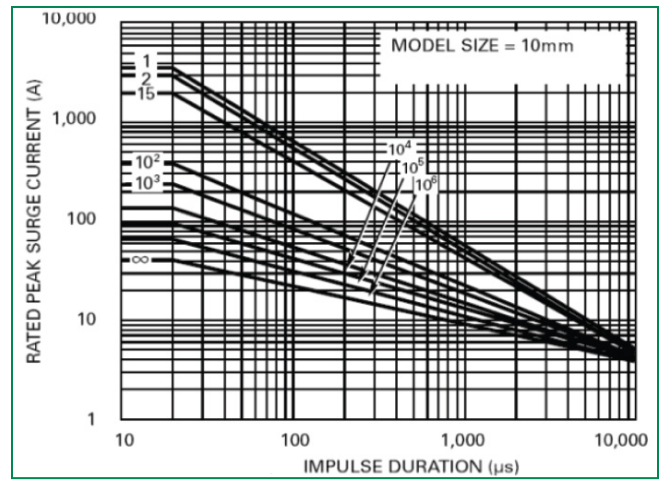

Repetitive Surge Capability for 14mm Parts

V14x14AUTO - V14x42AUTO

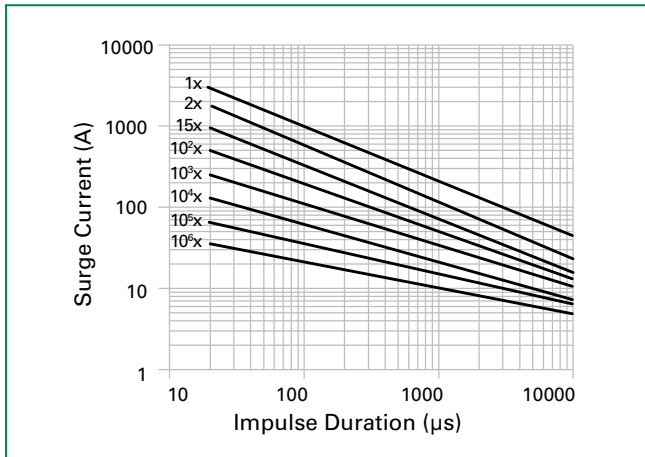

Repetitive Surge Capability for 14mm Parts

V14x50AUTO - V14x95AUTO

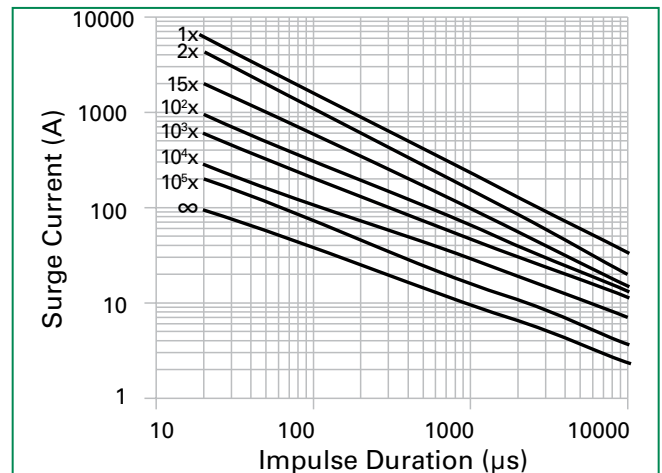

Repetitive Surge Capability for 14mm Parts

V14x130AUTO - V14x625AUTO

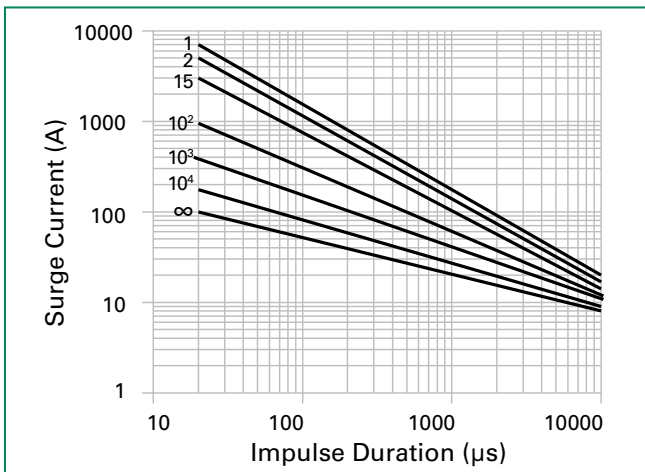

Repetitive Surge Capability for 20mm Parts

V020x14AUTO - V20x42AUTO

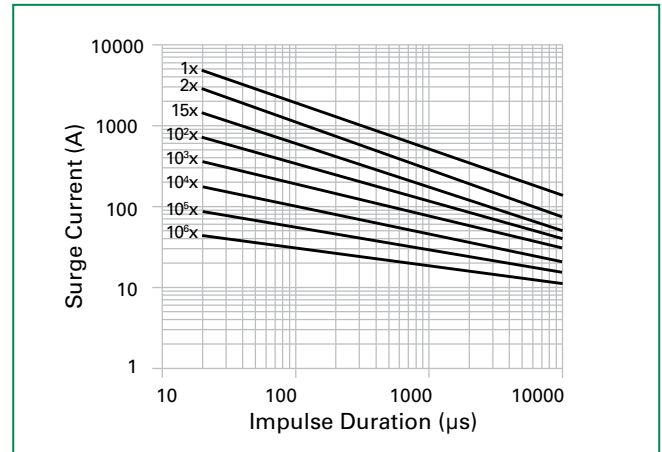

NOTE: If pulse ratings are exceeded, a shift of V_{NDCI} (at specified current) of more than $\pm 10\%$ could result. This type of shift, which normally results in a decrease of V_{NDCI} , may result in the device not meeting the original published specifications, but does not prevent the device from continuing to function, and to provide ample protection.

Repetitive Surge Capability for 20mm Parts

V20x50AUTO - V20x95AUTO

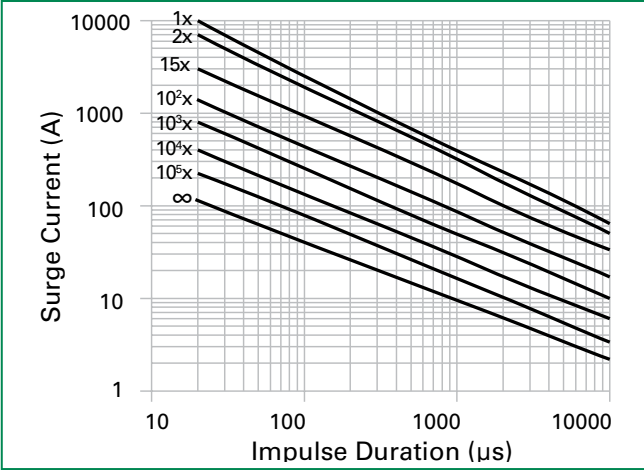

Repetitive Surge Capability for 20mm Parts

V20x130AUTO - V20x625AUTO

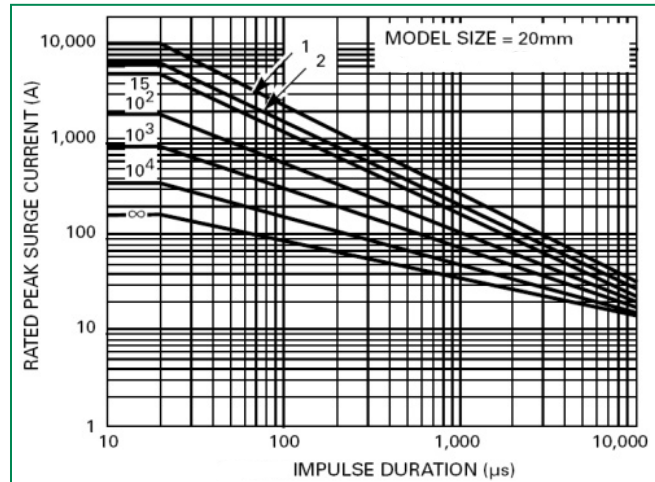

Wave Solder Profile

Non Lead-free Profile

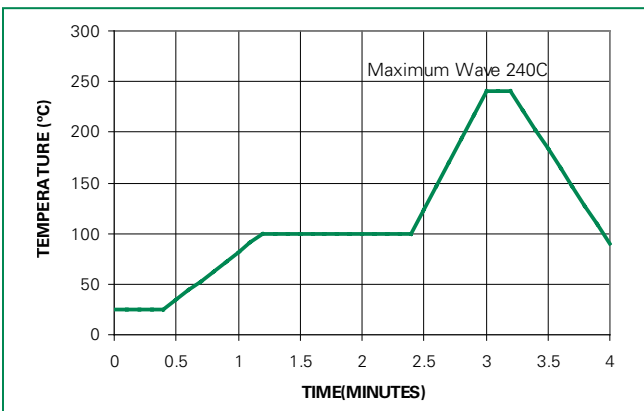

Lead-free Profile

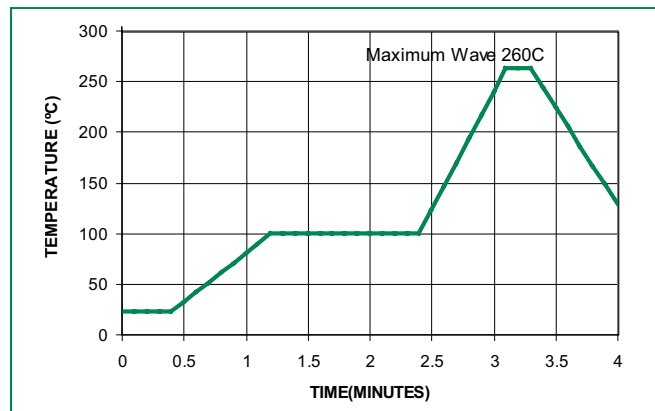

Physical Specifications

Lead Material	Copper Clad Steel Wire
Soldering Characteristics	Solderability per MIL-STD-202, Method 208
Insulating Material	Cured, flame retardant epoxy polymer meets UL94V-0 requirements
Device Labeling	Marked with LF, voltage and date code

Environmental Specifications

Humidity Aging	+85°C, 85% RH, 1000 hours +/-10% typical voltage change
Temperature Cycling Shock	-40°C to 125°C, 5 cycles for Epoxy coating; -40°C to 125°C, 1000 cycles for Phenolic and Silicone coating; +/-10% typical voltage change
Solvent Resistance	MIL-STD-202, Method 215
Moisture Sensitivity	Level 1, J-STD-020

Product Dimensions (mm)

Straight Lead

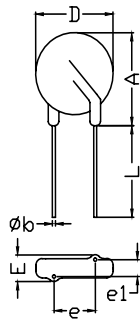

Outer Crimp Lead

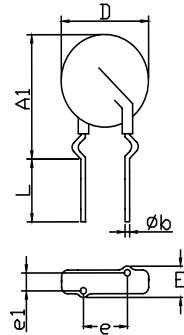

In-Line (Under Crimp) Lead

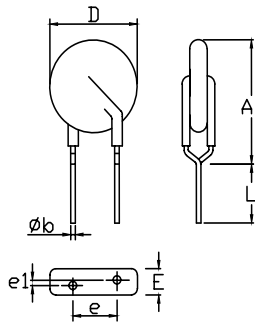

Inner Crimp Lead

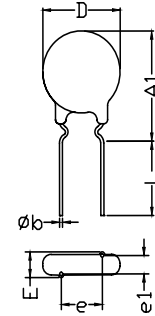

Dimension	V _{RMS} Voltage Model	5mm Size		7mm Size		10mm Size		14mm Size		20mm Size	
		Min. mm (in)	Max. mm (in)	Min. mm (in)	Max. mm (in)	Min. mm (in)	Max. mm (in)	Min. mm (in)	Max. mm (in)	Min. mm (in)	Max. mm (in)
A	11 - 320	-	10 (0.394)	-	12 (0.472)	-	16 (0.630)	-	20 (0.787)	-	26.5 (1.043)
	385 - 625	-	10.5 (0.413)	-	13 (0.512)	-	17.0 (0.689)	-	20.5 (0.807)	-	28.0 (1.102)
A1	All	-	13 (0.512)	-	15 (0.591)	-	19.5 (0.768)	-	22.5 (0.886)	-	29 (1.142)
ØD	All	-	7 (0.276)	-	9 (0.354)	-	12.5 (0.492)	-	17 (0.669)	-	23 (0.906)
e	11 - 95	4 (0.157)	6 (0.236)	4 (0.157)	6 (0.236)	6.5 (0.256)	8.5 (0.335)	6.5 (0.256)	8.5 (0.335)	6.5 (0.256)	8.5 (0.335)
	130 - 625									9.0 (0.354)	11.0 (0.433)
e₁	11 - 30	1 (0.039)	3 (0.118)	1 (0.039)	3 (0.118)	1 (0.039)	3 (0.118)	1 (0.039)	3 (0.118)	1 (0.039)	3 (0.118)
	35 - 320	1.5 (0.059)	3.5 (0.138)	1.5 (0.059)	3.5 (0.138)	1.5 (0.059)	3.5 (0.138)	1.5 (0.059)	3.5 (0.138)	1.5 (0.059)	3.5 (0.138)
	385 - 625	2.5 (0.098)	5.5 (0.217)	2.5 (0.098)	5.5 (0.217)	2.5 (0.098)	5.5 (0.217)	2.5 (0.098)	5.5 (0.217)	2.5 (0.098)	5.5 (0.217)
E	11 - 30	-	5.0 (0.197)	-	5.0 (0.197)	-	5.0 (0.197)	-	5.0 (0.197)	-	5.0 (0.197)
	35 - 320	-	5.6 (0.220)	-	5.6 (0.220)	-	5.6 (0.220)	-	5.6 (0.220)	-	5.6 (0.220)
	385 - 510	-	7.3 (0.287)	-	7.3 (0.287)	-	7.3 (0.287)	-	7.3 (0.287)	-	7.3 (0.287)
	550 - 625	-	8.3 (0.327)	-	8.3 (0.327)	-	8.3 (0.327)	-	8.3 (0.327)	-	8.3 (0.327)
øb	All	0.585 (0.023)	0.685 (0.027)	0.585 (0.023)	0.685 (0.027)	0.76 (0.030)	0.86 (0.034)	0.76 (0.030)	0.86 (0.034)	0.76 (0.030)	0.86 (0.034)
L	All	25.4 (1.00)	-	25.4 (1.00)	-	25.4 (1.00)	-	25.4 (1.00)	-	25.4 (1.00)	-
L_{TRIM}	All	2.41 (0.095)	4.69 (0.185)	2.41 (0.095)	4.69 (0.185)	2.41 (0.095)	4.69 (0.185)	2.41 (0.095)	4.69 (0.185)	2.41 (0.095)	4.69 (0.185)

Note: Dimensions in millimetres, (Inches) is typical.

Tape and Reel Specifications

5 and 7mm Devices

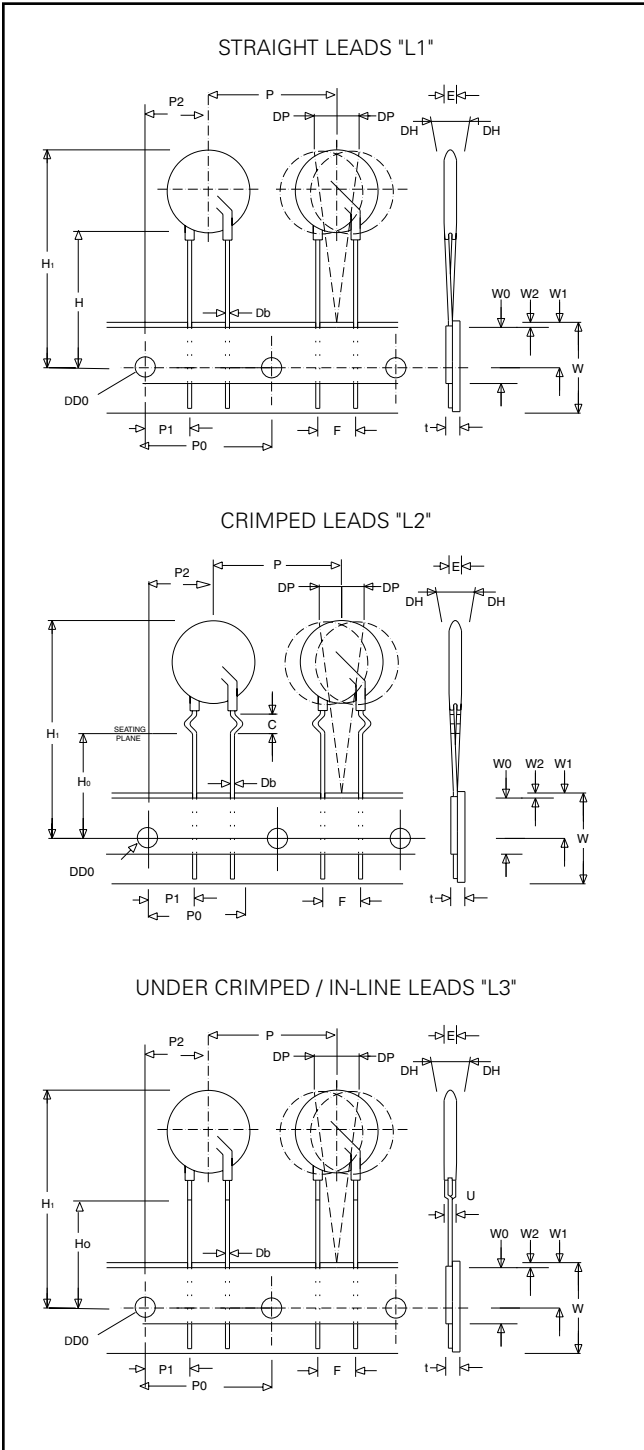

10, 14 and 20mm Devices

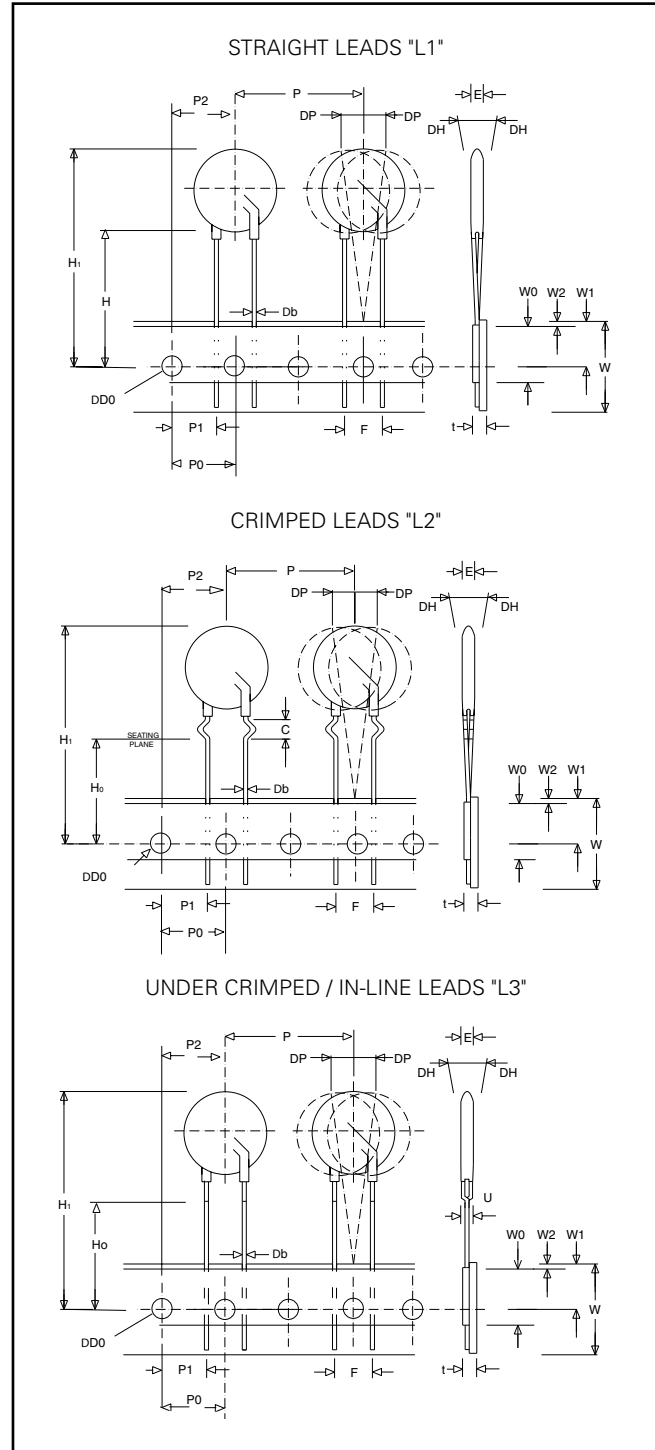

Refer to next page for dimension measurement specifics.

Disclaimer Notice - Information furnished is believed to be accurate and reliable. However, users should independently evaluate the suitability of and test each product selected for their own applications. Littelfuse products are not designed for, and may not be used in, all applications. Read complete Disclaimer Notice at www.littelfuse.com/disclaimer-electronics.

Tape and Reel Specifications (continued)

NOTES:

- Radial devices on tape are supplied with crimped leads, straight leads, or under-crimped leads
- Leads are offset by product dimension e1
- Conforms to ANSI and EIA specifications
- Can be supplied to IEC Publication 286-2
- 10mm parts are available on tape and reel up to 510 VAC only
- 14mm and 20mm parts are available on tape and reel up to 550 VAC only

SYMBOL	DESCRIPTION	MODEL SIZE					
		5mm	7mm	10mm	14mm	20mm	
					(11Vac to 95Vac voltage)	≥115 Vac Voltage	
P	Pitch of Component	12.7 +/- 1.0	12.7 +/- 1.0	25.4 +/- 1.0	25.4 +/- 1.0	25.4 +/- 1.0	25.4 +/- 1.0
P₀	Feed Hole Pitch	12.7 +/- 0.2	12.7 +/- 0.2	12.7 +/- 0.2	12.7 +/- 0.2	12.7 +/- 0.2	12.7 +/- 0.2
P₁	Feed Hole Center to Pitch	3.85 +/- 0.7	3.85 +/- 0.7	8.85 +/- 0.7	8.85 +/- 0.7	8.85 +/- 0.7	7.70 +/- 0.7
P₂	Hole Center to Component Center	6.35 +/- 1.0	6.35 +/- 1.0	12.7 +/- 0.7	12.7 +/- 0.7	12.7 +/- 0.7	12.7 +/- 0.7
F	Lead to Lead Distance	5.0 +/- 1.0	5.0 +/- 1.0	7.5 +/- 1.0	7.5 +/- 1.0	7.5 +/- 1.0	10 +/- 1.0
h	Component Alignment	2.0 Max	2.0 Max	2.0 Max	2.0 Max	2.0 Max	2.0 Max
W	Tape Width	18.0 +1.0 / -0.5	18.0 +1.0 / -0.5	18.0 +1.0 / -0.5	18.0 +1.0 / -0.5	18.0 +1.0 / -0.5	18.0 + 1.0 / -0.5
W₀	Hold Down Tape Width	12.0 +/- 0.3	12.0 +/- 0.3	12.0 +/- 0.3	12.0 +/- 0.3	12.0 +/- 0.3	12.0 +/- 0.3
W₁	Hole Position	9.0 +0.75 / -0.50	9.0 +0.75 / -0.50	9.0 +0.75 / -0.50	9.0 +0.75 / -0.50	9.0 +0.75 / -0.50	9.0 +0.75 / -0.50
W₂	Hold Down Tape Position	0.5 Max	0.5 Max	0.5 Max	0.5 Max	0.5 Max	0.5 Max
H	Height from Tape Center to Component Base	18.0 +2.0 / -0.0	18.0 +2.0 / -0.0	18.0 +2.0 / -0.0	18.0 +2.0 / -0.0	18.0 +2.0 / -0.0	18.0 +2.0 / -0.0
H₀	Seating Plane Height	16.0 +/- 0.5	16.0 +/- 0.5	16.0 +/- 0.5	16.0 +/- 0.5	16.0 +/- 0.5	16.0 +/- 0.5
H₁	Component Height	29.0 Max	32.0 Max	36.0 Max	40.0 Max	46.5 Max	46.5 Max
D₀	Feed Hole Diameter	4.0 +/- 0.2	4.0 +/- 0.2	4.0 +/- 0.2	4.0 +/- 0.2	4.0 +/- 0.2	4.0 +/- 0.2
t	Total Tape Thickness	0.7 +/- 0.2	0.7 +/- 0.2	0.7 +/- 0.2	0.7 +/- 0.2	0.7 +/- 0.2	0.7 +/- 0.2
U	Undercrimp Width	8.0 Max	8.0 Max	8.0 Max	8.0 Max	8.0 Max	8.0 Max
p	Component Alignment	3° Max	3° Max	3° Max	3° Max	3° Max	3° Max

Part Numbering System

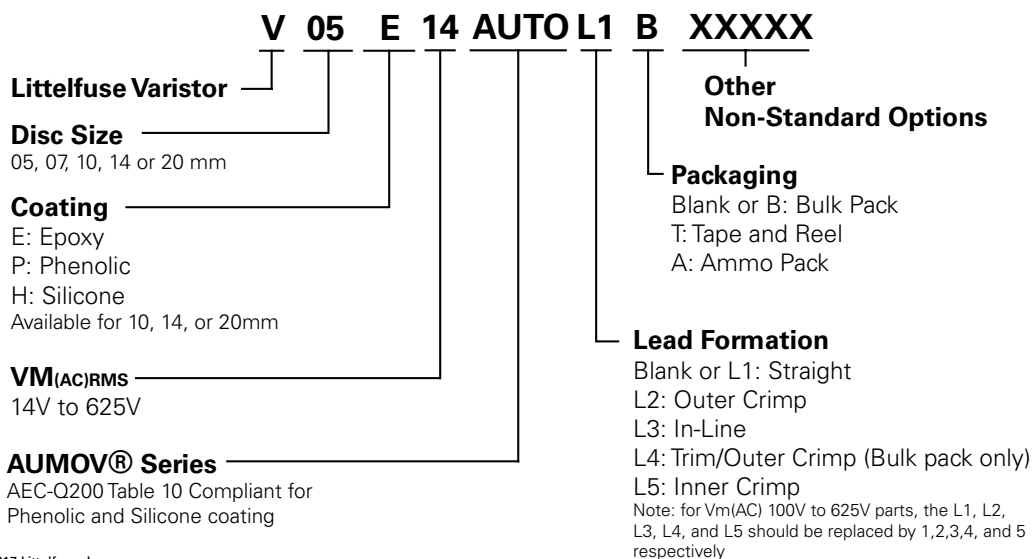

HMOV™ Varistor Series



Description



The HMOV™ Varistor Series is specifically designed for applications requiring high surge energy absorption and high operating temperature of 125°C.

The maximum peak surge current is rated up to 10kA (8/20µs pulse) to protect against indirect lightning strikes, switching surge transients, and abnormally fast transients.

Features

- High operating temperature combined with high isolation voltage capability: 125°C and 2500V, respectively
- High surge current withstanding capability up to 10kA (8/20µs pulse)
- Complies with 1000 cycle, -55°C to 125°C, Thermal Shock Cycling Test
- Wide operating voltage range
- Three disc sizes available: 10mm, 14mm, and 20mm
- Lead-free, Halogen-free, and RoHS compliant

Agency Approvals

Agency	Agency Approval	Agency File Number
	UL1449	E320116
	IEC 60950-1(Annex Q) IECQ CS 042200 GB 0001	IECQ-C BSI 15.0013 E1291/F

Additional Information



Datashheet



Resources



Samples

Applications

- LED lighting
- Security System (fire alarm or smoke detector)
- Solar Power Inverter
- Automation control
- Power Supply Unit (outdoor and industrial)

Absolute Maximum Ratings

• See Device Ratings and Specifications chart for ratings of individual members of a series.

	Low Voltage Series	Units
Continuous:		
Steady State Applied Voltage:		
AC Voltage Range (V_{MACRMS})	11 to 625	V
DC Voltage Range (V_{MDC})	14 to 825	V
Transient:		
Non-Repetitive Surge Current, 8/20µs Waveform (I_{TM})	800 to 10,000	A
Non-Repetitive Energy Capability, 2ms Waveform (W_{TM})	0.8 to 150	J
Operating Ambient Temperature Range (T_A)	-55 to +125	°C
Storage Temperature Range (T_{STG})	-55 to +150	°C
Temperature Coefficient (αV) of Clamping Voltage (V_C) at Specified Test Current	< 0.01%	°C
Hi-Pot Encapsulation (Isolation Voltage Capability)	2500	V
Silicone Coating Insulation Resistance	>1,000	MΩ

CAUTION: Stresses above those listed in "Absolute Maximum Ratings" may cause permanent damage to the device. This is a stress only rating and operation of the device at these or any other conditions above those indicated in the operational sections of this specification is not implied.

HMOV[™] Series Device Ratings and Specifications

Silicone Coated Models		Size Disc Dia. (mm)	Maximum Rating (125°C)					Specifications (25°C)				
			Max Continuous Voltage		Max Peak Current (8/20µs)		Energy Rating (2ms, 1 pulse)	Varistor Voltage at 1mA		Maximum Clamping Voltage (8 x 20µs)		Typical Capacitance f = 1MHz
			V _{M(AC) RMS}	V _{M(DC)}	I _{TM} 1 x Pulse	I _{TM} 2 x Pulses	W _{TM}	V _{NOM} Min	V _{NOM} Max	V _C	I _{PK}	C
			(V)	(V)	(A)	(A)	(J)	(V)	(V)	(V)	(A)	(pF)
Part Number (Base part)	Branding											
V10H11P	P10H11	10	11	14	1500	800	4.2	16.2	19.8	36	5	5450
V14H11P	P14H11	14	11	14	3000	1800	8	16.2	19.8	36	10	12000
V20H11P	P20H11	20	11	14	5000	3000	25	16.2	19.8	36	20	26000
V10H14P	P10H14	10	14	18	1500	800	5	19.8	24.2	43	5	4650
V14H14P	P14H14	14	14	18	3000	1800	10	19.8	24.2	43	10	10200
V20H14P	P20H14	20	14	18	5000	3000	28	19.8	24.2	43	20	22200
V10H17P	P10H17	10	17	22	1500	800	6.5	24.3	29.7	53	5	3900
V14H17P	P14H17	14	17	22	3000	1800	13	24.3	29.7	53	10	8700
V20H17P	P20H17	20	17	22	5000	3000	35	24.3	29.7	53	20	18750
V10H20P	P10H20	10	20	26	1500	800	10	29.7	36.3	65	5	3400
V14H20P	P14H20	14	20	26	3000	1800	20	29.7	36.3	65	10	7500
V20H20P	P20H20	20	20	26	5000	3000	58	29.7	36.3	65	20	15000
V10H23P	P10H23	10	23	28	1500	800	12	32.4	39.6	71	5	3200
V14H23P	P14H23	14	23	28	3000	1800	23	32.4	39.6	71	10	7000
V20H23P	P20H23	20	23	28	5000	3000	70	32.4	39.6	71	20	14000
V10H25P	P10H25	10	25	31	1500	800	13	35.1	42.9	77	5	2900
V14H25P	P14H25	14	25	31	3000	1800	25	35.1	42.9	77	10	6200
V20H25P	P20H25	20	25	31	5000	3000	77	35.1	42.9	77	20	13500
V10H30P	P10H30	10	30	38	1500	800	15.5	42.3	51.7	93	5	2550
V14H30P	P14H30	14	30	38	3000	1800	32	42.3	51.7	93	10	5550
V20H30P	P20H30	20	30	38	5000	3000	90	42.3	51.7	93	20	12000
V10H35P	P10H35	10	35	45	1500	800	20	50.4	61.6	110	5	2200
V14H35P	P14H35	14	35	45	3000	1800	40	50.4	61.6	110	10	5000
V20H35P	P20H35	20	35	45	5000	3000	115	50.4	61.6	110	20	10500
V10H40P	P10H40	10	40	56	1500	800	25	61.2	74.8	135	5	1850
V14H40P	P14H40	14	40	56	3000	1800	50	61.2	74.8	135	10	4000
V20H40P	P20H40	20	40	56	5000	3000	140	61.2	74.8	135	20	8500
V10H50P	P10H50	10	50	65	3500	3000	20	73.8	90.2	135	25	1400
V14H50P	P14H50	14	50	65	6500	5000	40	73.8	90.2	145	50	3000
V20H50P	P20H50	20	50	65	10000	7000	80	73.8	90.2	145	100	6000
V10H60P	P10H60	10	60	85	3500	3000	24	90	110	165	25	1200
V14H60P	P14H60	14	60	85	6500	5000	50	90	110	175	50	2500
V20H60P	P20H60	20	60	85	10000	7000	100	90	110	175	100	5200
V10H75P	P10H75	10	75	100	3500	3000	29	108	132	200	25	1100
V14H75P	P14H75	14	75	100	6500	5000	60	108	132	210	50	2300
V20H75P	P20H75	20	75	100	10000	7000	120	108	132	210	100	4800
V10H95P	P10H95	10	95	125	3500	3000	36	135	165	250	25	800
V14H95P	P14H95	14	95	125	6500	5000	75	135	165	250	50	1700
V20H95P	P20H95	20	95	125	10000	7000	150	135	165	250	100	3700
V10H115P	P10H115	10	115	153	3500	3000	30	162	198	300	25	465
V14H115P	P14H115	14	115	153	6500	5000	50	162	198	300	50	1190
V20H115P	P20H115	20	115	153	10000	7000	120	162	198	300	100	2400
V10H130P	P10H130	10	130	170	3500	3000	40	184.5	225.5	340	25	450
V14H130P	P14H130	14	130	170	6500	5000	60	184.5	225.5	340	50	1000
V20H130P	P20H130	20	130	170	10000	7000	145	184.5	225.5	340	100	1900
V10H140P	P10H140	10	140	180	3500	3000	45	198	242	360	25	400

Note: 1. Average power dissipation of transients not to exceed 0.4W, 0.6W or 1W for model sizes 10mm, 14mm, and 20mm, respectively.

HMOV™ Series Device Ratings and Specifications

		Maximum Rating (125°C)						Specifications (25°C)				
		Size Disc Dia. (mm)	Max Continuous Voltage		Max Peak Current (8/20µs)		Energy Rating (2ms, 1 pulse)	Varistor Voltage at 1mA		Maximum Clamping Voltage (8 x 20µs)		Typical Capacitance f = 1MHz
Part Number (Base part)	Branding		$V_{M(AC) RMS}$	$V_{M(DC)}$	$I_{TM} 1 \times \text{Pulse}$	$I_{TM} 2 \times \text{Pulses}$	W_{TM}	$V_{NOM} \text{ Min}$	$V_{NOM} \text{ Max}$	V_C	I_{PK}	C
			(V)	(V)	(A)	(A)	(J)	(V)	(V)	(V)	(A)	(pF)
V14H140P	P14H140	14	140	180	6500	5000	65	198	242	360	50	900
V20H140P	P20H140	20	140	180	10000	7000	155	198	242	360	100	1750
V10H150P	P10H150	10	150	200	3500	3000	50	216	264	395	25	360
V14H150P	P14H150	14	150	200	6500	5000	70	216	264	395	50	800
V20H150P	P20H150	20	150	200	10000	7000	165	216	264	395	100	1600
V10H175P	P10H175	10	175	225	3500	3000	55	243	297	455	25	350
V14H175P	P14H175	14	175	225	6500	5000	80	243	297	455	50	700
V20H175P	P20H175	20	175	225	10000	7000	180	243	297	455	100	1400
V10H230P	P10H230	10	230	300	3500	3000	60	324	396	595	25	250
V14H230P	P14H230	14	230	300	6500	5000	105	324	396	595	50	550
V20H230P	P20H230	20	230	300	10000	7000	225	324	396	595	100	1100
V10H250P	P10H250	10	250	320	3500	3000	65	351	429	650	25	220
V14H250P	P14H250	14	250	320	6500	5000	115	351	429	650	50	500
V20H250P	P20H250	20	250	320	10000	7000	240	351	429	650	100	1000
V10H275P	P10H275	10	275	350	3500	3000	70	387	473	710	25	200
V14H275P	P14H275	14	275	350	6500	5000	130	387	473	710	50	450
V20H275P	P20H275	20	275	350	10000	7000	260	387	473	710	100	900
V10H300P	P10H300	10	300	385	3500	3000	75	423	517	775	25	180
V14H300P	P14H300	14	300	385	6500	5000	140	423	517	775	50	400
V20H300P	P20H300	20	300	385	10000	7000	290	423	517	775	100	800
V10H320P	P10H320	10	320	420	3500	3000	80	459	561	840	25	170
V14H320P	P14H320	14	320	420	6500	5000	150	459	561	840	50	380
V20H320P	P20H320	20	320	420	10000	7000	320	459	561	840	100	750
V10H385P	P10H385	10	385	505	3500	3000	85	558	682	1025	25	160
V14H385P	P14H385	14	385	505	6500	5000	175	558	682	1025	50	360
V20H385P	P20H385	20	385	505	10000	7000	325	558	682	1025	100	700
V10H420P	P10H420	10	420	560	3500	3000	90	612	748	1120	25	140
V14H420P	P14H420	14	420	560	6500	5000	185	612	748	1120	50	300
V20H420P	P20H420	20	420	560	10000	7000	330	612	748	1120	100	600
V10H440P	P10H440	10	440	585	3500	3000	95	643.5	786.5	1180	25	130
V14H440P	P14H440	14	440	585	6500	5000	185	643.5	786.5	1180	50	260
V20H440P	P20H440	20	440	585	10000	7000	340	643.5	786.5	1180	100	500
V10H460P	P10H460	10	460	615	3500	3000	95	675	825	1240	25	120
V14H460P	P14H460	14	460	615	6500	5000	190	675	825	1240	50	220
V20H460P	P20H460	20	460	615	10000	7000	370	675	825	1240	100	400
V10H510P	P10H510	10	510	670	3500	3000	98	738	902	1355	25	110
V14H510P	P14H510	14	510	670	6500	5000	205	738	902	1355	50	200
V20H510P	P20H510	20	510	670	10000	7000	410	738	902	1355	100	350
V10H550P	P10H550	10	550	745	3500	3000	98	819	1001	1500	25	100
V14H550P	P14H550	14	550	745	6500	5000	210	819	1001	1500	50	180
V20H550P	P20H550	20	550	745	10000	7000	450	819	1001	1500	100	300
V10H625P	P10H625	10	625	825	3500	3000	110	900	1100	1650	25	90
V14H625P	P14H625	14	625	825	6500	5000	235	900	1100	1650	50	160
V20H625P	P20H625	20	625	825	10000	7000	490	900	1100	1650	100	250

Note: 1. Average power dissipation of transients not to exceed 0.4W, 0.6W or 1W for model sizes 10mm, 14mm, and 20mm respectively..

Current Energy and Power Dissipation Ratings

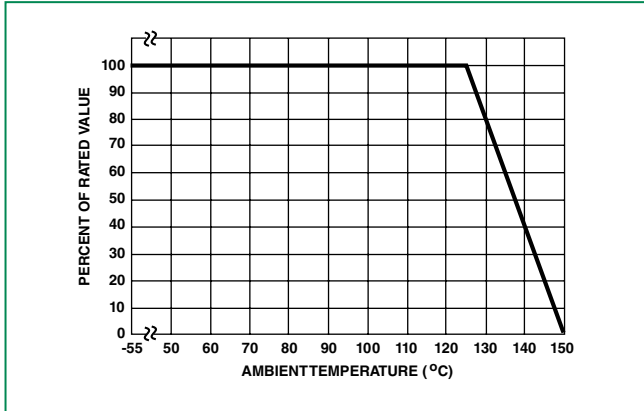

Note:
 The peak surge current and energy ratings must be reduced for applications exceeding 125°C ambient temperature.

Peak Pulse Current Test Waveform for Clamping Voltage

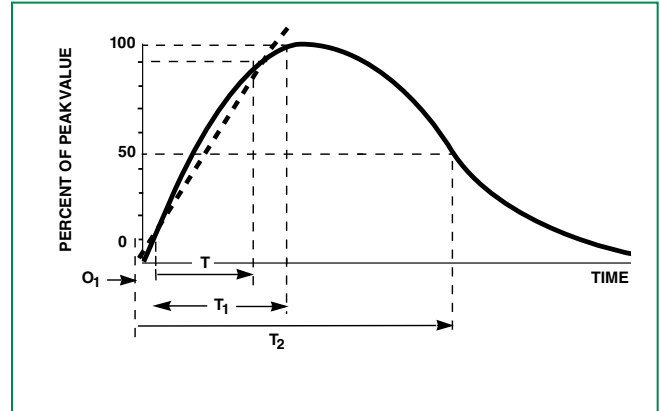

O_1 = Virtual Origin of Wave
 T = Time from 10% to 90% of Peak
 T_1 = Rise Time = $1.25 \times T$
 T_2 = Decay Time
Example - For an 8/20µs Current Waveform:
 $8\mu s = T_1$ = Rise Time
 $20\mu s = T_2$ = Decay Time

Maximum Clamping Voltage for 10mm Parts

V10x11P - V10x40P

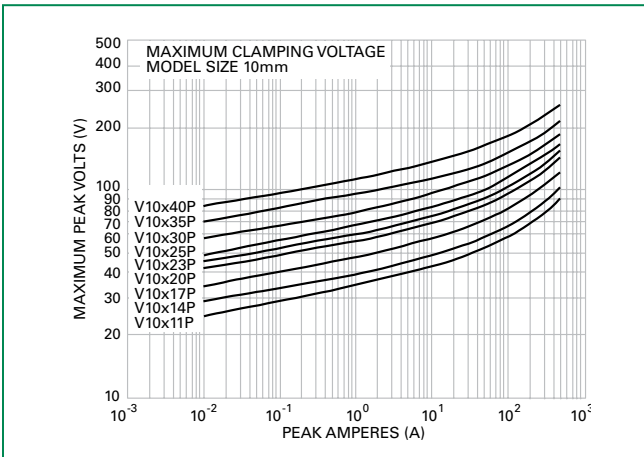

Maximum Clamping Voltage for 20mm Parts

V20x11P - V20x40P

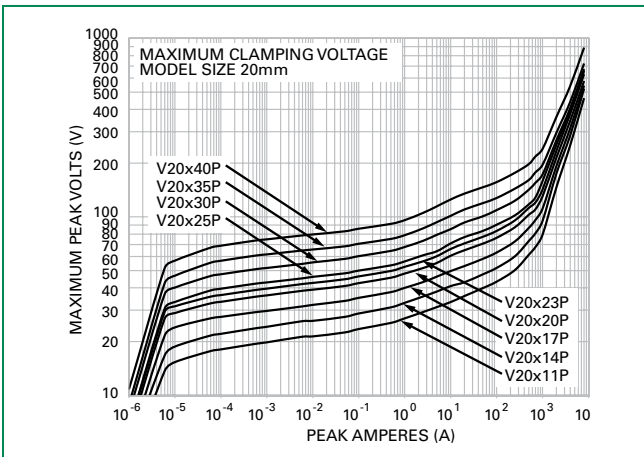

Maximum Clamping Voltage for 14mm Parts

V14x11P - V14x40P

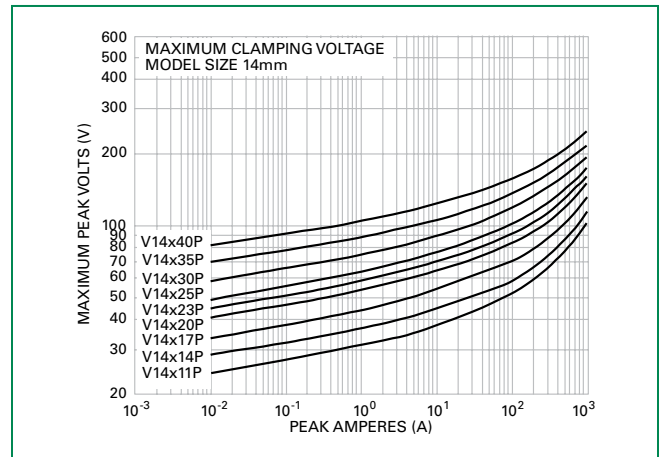

Maximum Clamping Voltage for 10mm Parts

V10x50P - V10x115P

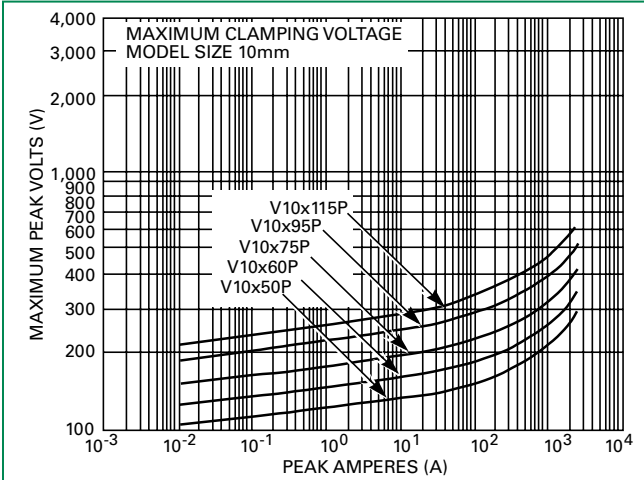

Maximum Clamping Voltage for 10mm Parts

V10x130P - V10x625P

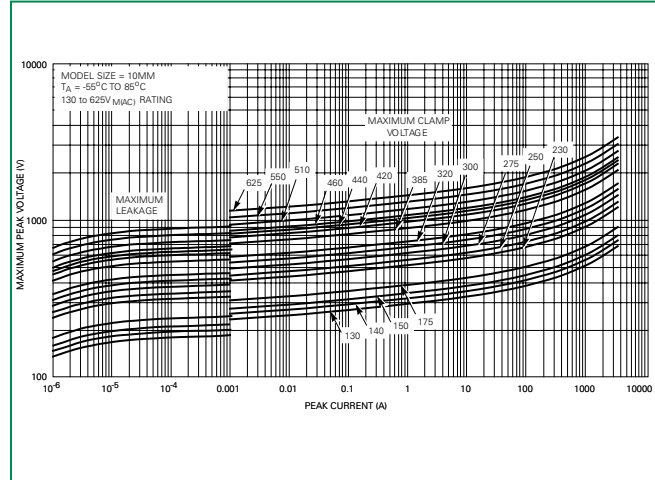

Maximum Clamping Voltage for 20mm Parts

V20x50P - V20x115P

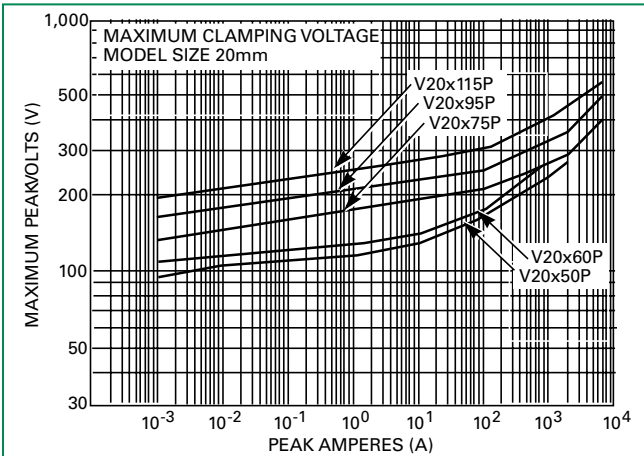

Maximum Clamping Voltage for 14mm Parts

V14x50P - V14x115P

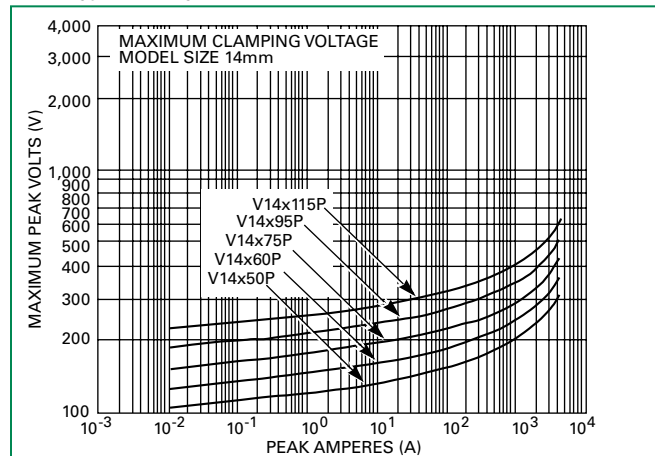

Maximum Clamping Voltage for 14mm Parts

V14x130P - V14x625P

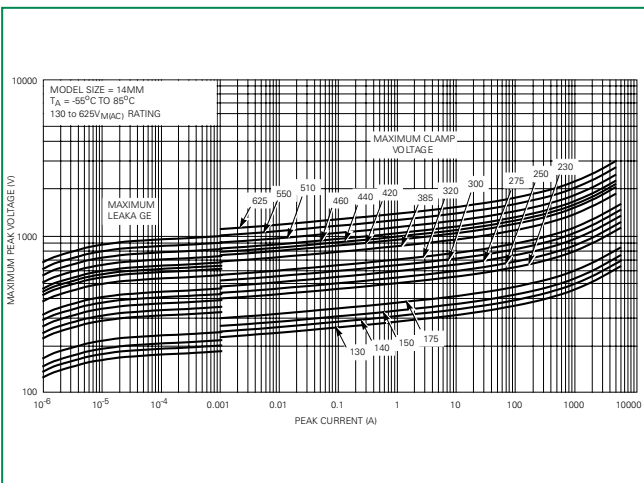

Maximum Clamping Voltage for 20mm Parts

V20x130P - V20x625P

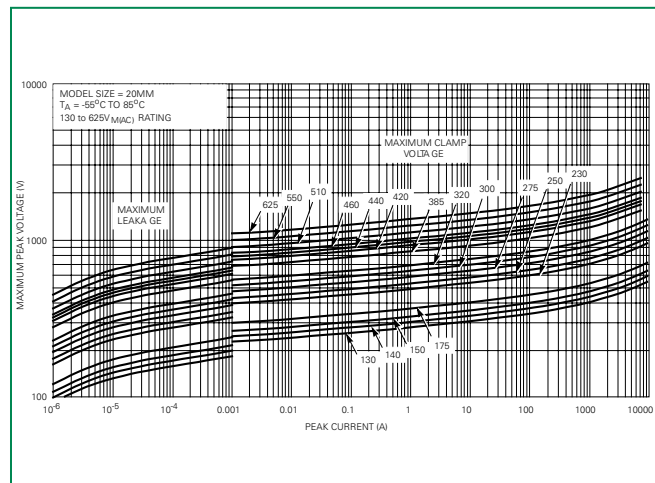

Repetitive Surge Capability for 10mm Parts

V10x11P - V10x40P

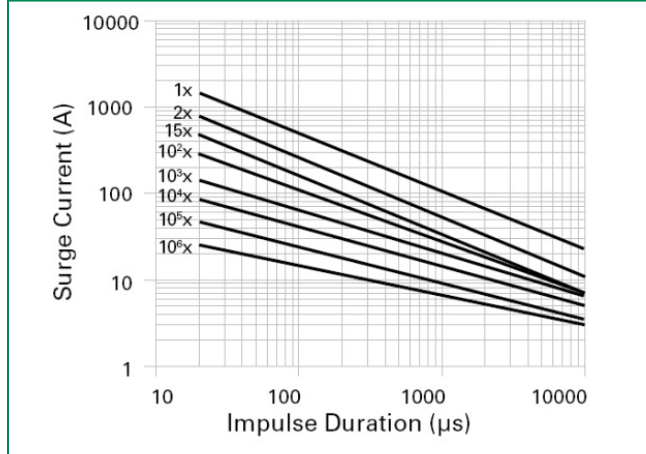

Repetitive Surge Capability for 14mm Parts

V14x11P - V14x40P

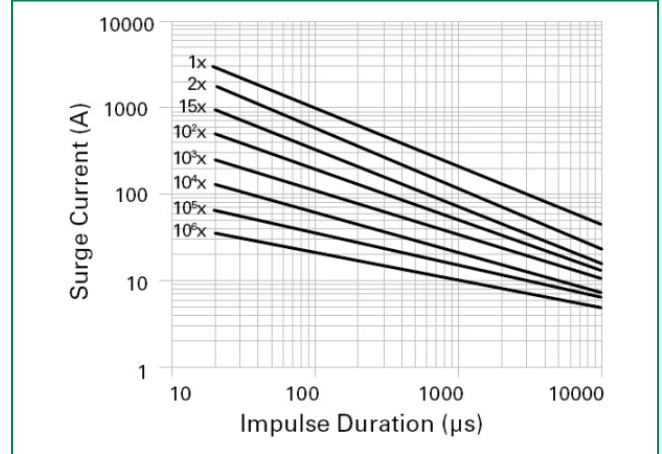

Repetitive Surge Capability for 20mm Parts

V20x11P - V20x40P

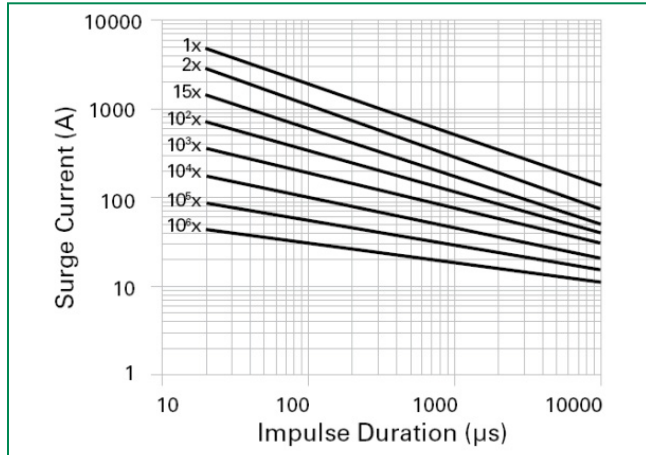

Maximum Clamping Voltage 10mm Parts

V10x115P - V10x625P

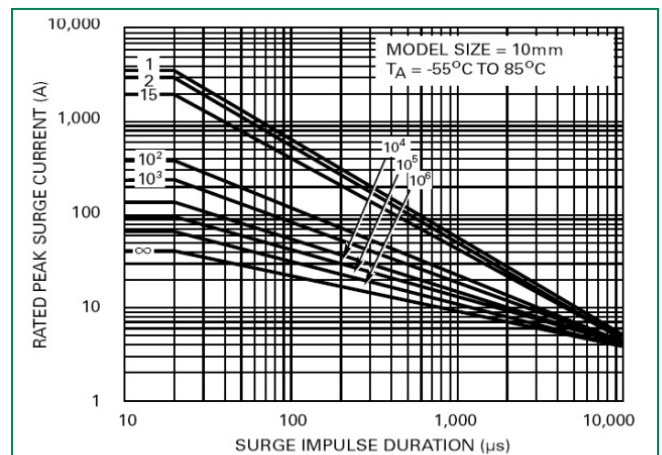

NOTE: If pulse ratings are exceeded, a shift of V_{NDCI} (at specified current) of more than +/-10% could result. This type of shift, which normally results in a decrease of V_{NDCI} , may result in the device not meeting the original published specifications, but does not prevent the device from continuing to function, and to provide ample protection.

Repetitive Surge Capability for 10mm Parts

V10x50P - V10x95P

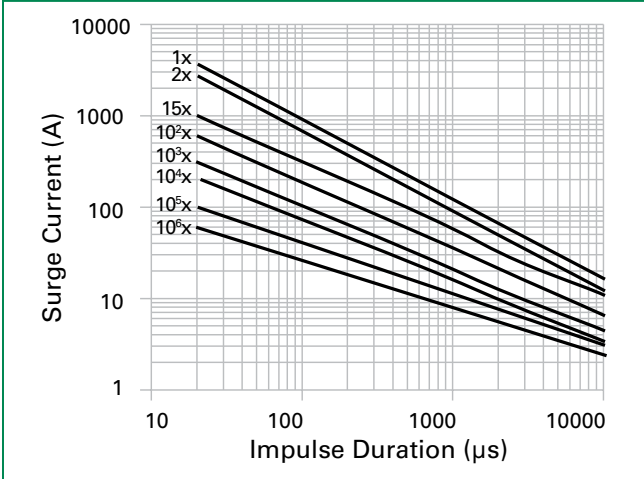

Repetitive Surge Capability for 14mm Parts

V14x50P - V14x95P

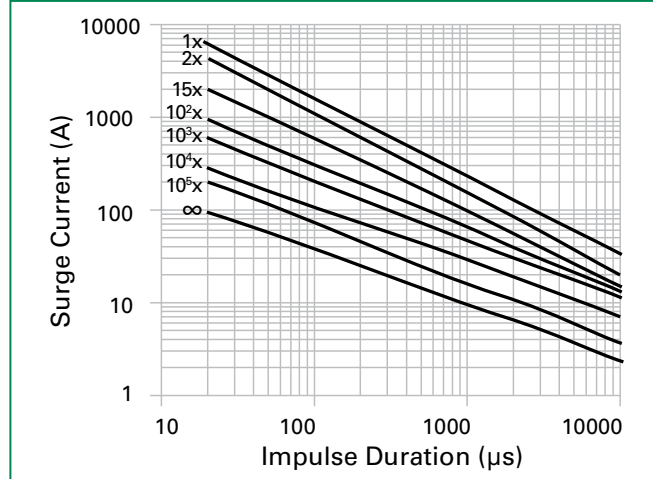

Repetitive Surge Capability for 20mm Parts

V20x50P - V20x95P

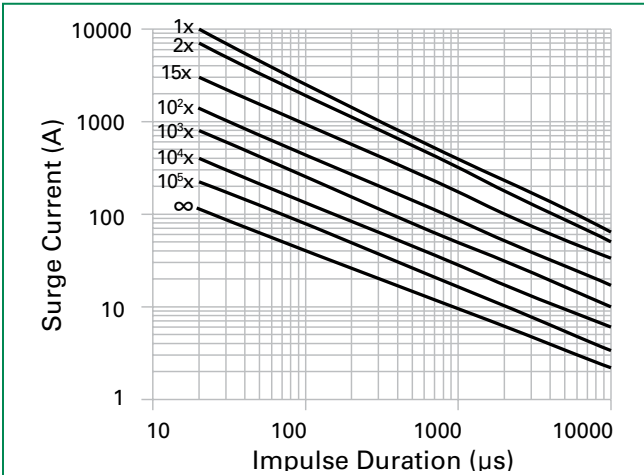

Repetitive Surge Capability for 14mm Parts

V14x115P - V14x625P

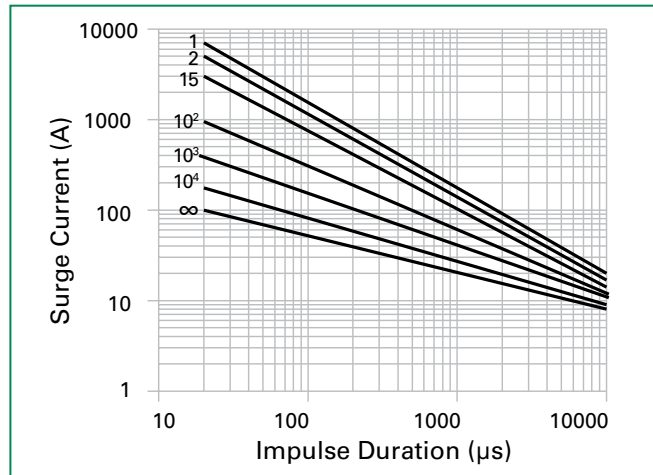

Repetitive Surge Capability for 20mm Parts

V20x115P - V20x625P

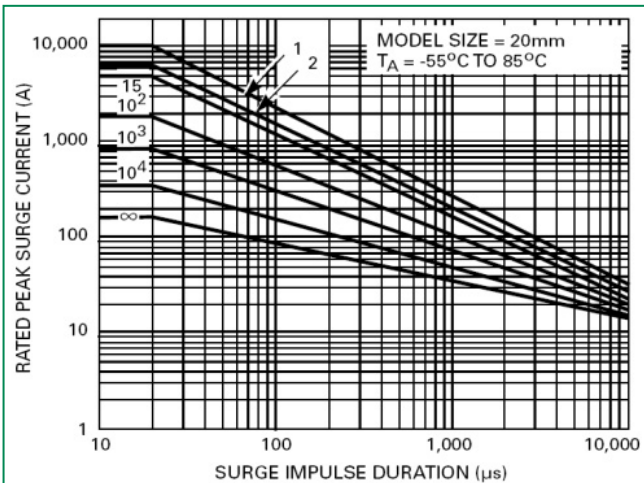

Wave Solder Profile

Non Lead-free Profile

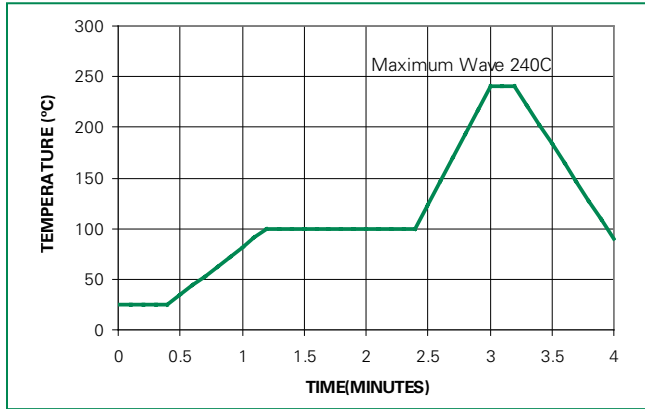

Lead-free Profile



Physical Specifications

Lead Material	Copper Clad Steel Wire
Soldering Characteristics	Solderability per MIL-STD-202, Method 208
Insulating Material	Cured, Silicone meets UL94V-0 requirements
Device Labeling	Marked with LF, voltage and date code

Environmental Specifications

Humidity Aging	+85°C, 85% RH, 1500 hours +/-10% typical voltage change
Thermal Shock	-55°C to +125°C, 1000 cycles +/-10% typical voltage change
Solvent Resistance	MIL-STD-202, Method 215
Moisture Sensitivity	Level 1, J-STD-020

Product Dimensions (mm)

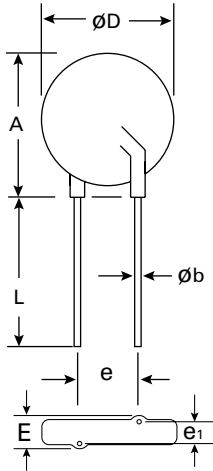
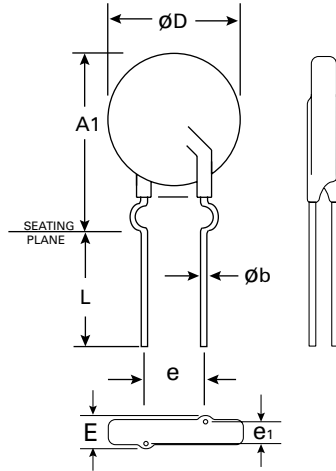
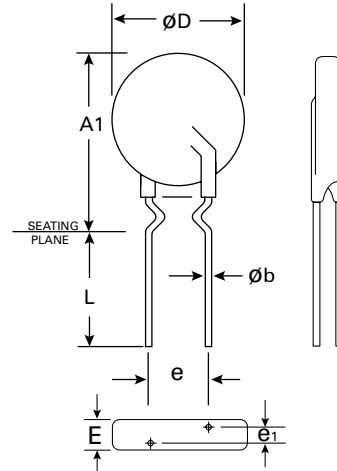
Straight Lead Option

Outer Crimped Lead Option

Inner Crimped Lead Option

Dimension	V _{RMS} Voltage Model	10mm Size		14mm Size		20mm Size	
		Min. mm (in)	Max. mm (in)	Min. mm (in)	Max. mm (in)	Min. mm (in)	Max. mm (in)
A	11 - 320	-	16 (0.630)	-	20 (0.787)	-	26.5 (1.043)
	385 - 625	-	17 (0.689)	-	20.5 (0.807)	-	28.0 (1.102)
A1	All	-	19.5 (0.768)	-	22.5 (0.886)	-	29.0 (1.142)
ØD	All	-	12.5 (0.492)	-	17 (0.669)	-	23.0 (0.906)
e	11 - 95	6.5 (0.256)	8.5 (0.335)	6.5 (0.256)	8.5 (0.335)	6.5 (0.256)	8.5 (0.335)
	≥115					9.0 (0.354)	11.0 (0.433)
e₁	11 - 30	1.0 (0.039)	3.0 (0.118)	1.0 (0.039)	3.0 (0.118)	1.0 (0.039)	3.0 (0.118)
	35 - 320	1.5 (0.059)	3.5 (0.138)	1.5 (0.059)	3.5 (0.138)	1.5 (0.059)	3.5 (0.138)
	385 - 625	2.5 (0.098)	5.5 (0.217)	2.5 (0.098)	5.5 (0.217)	2.5 (0.098)	5.5 (0.217)
E	11 - 30	-	5.0 (0.197)	-	5.0 (0.197)	-	5.0 (0.197)
	35 - 320	-	5.6 (0.220)	-	5.6 (0.220)	-	5.6 (0.220)
	385 - 510	-	7.3 (0.287)	-	7.3 (0.287)	-	7.3 (0.287)
	550 - 625	-	8.3 (0.327)	-	8.3 (0.327)	-	8.3 (0.327)
Øb	All	0.76 (0.030)	0.86 (0.034)	0.76 (0.030)	0.86 (0.034)	0.76 (0.030)	0.86 (0.034)
L	All	25.4 (1.00)	-	25.4 (1.00)	-	25.4 (1.00)	-
L_{TRIM}	All	2.5 (0.098)	4.5 (0.177)	2.5 (0.098)	4.5 (0.177)	2.5 (0.098)	4.5 (0.177)

Note: Dimensions in Millimetres (Inches) are typical.

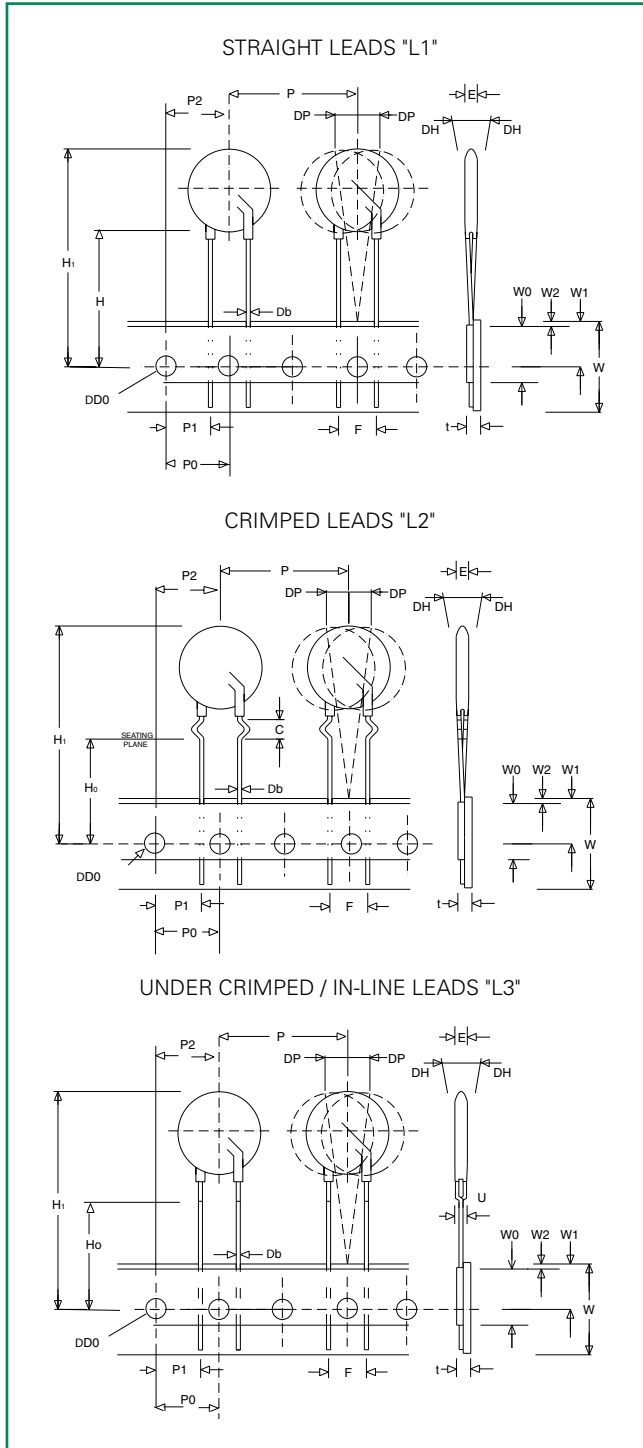
Tape and Reel Specifications

10, 14, and 20mm Devices



Refer next page for dimension measurement specifications.

Disclaimer Notice - Information furnished is believed to be accurate and reliable. However, users should independently evaluate the suitability of and test each product selected for their own applications. Littelfuse products are not designed for, and may not be used in, all applications. Read complete Disclaimer Notice at www.littelfuse.com/disclaimer-electronics.

Tape and Reel Specifications (continued)

NOTES:

- Radial devices on tape are supplied with crimped leads, straight leads, or under-crimped leads
- Leads are offset by product dimension e1
- Conforms to ANSI and EIA specifications
- Can be supplied to IEC Publication 286-2

SYMBOL	DESCRIPTION	10mm	14mm	20mm	
				(11Vac to 95Vac voltage)	(≥115Vac voltage)
P	Pitch of Component	25.4 +/- 1.0	25.4 +/- 1.0	25.4 +/- 1.0	25.4 +/- 1.0
P₀	Feed Hole Pitch	12.7 +/- 0.2	12.7 +/- 0.2	12.7 +/- 0.2	12.7 +/- 0.2
P₁	Feed Hole Center to Pitch	8.85 +/- 0.7	8.85 +/- 0.7	8.85 +/- 0.7	7.70 +/- 0.7
P₂	Hole Center to Component Center	12.7 +/- 0.7	12.7 +/- 0.7	12.7 +/- 0.7	12.7 +/- 0.7
F	Lead to Lead Distance	7.5 +/- 1.0	7.5 +/- 1.0	7.5 +/- 1.0	10 +/- 1.0
h	Component Alignment	2.0 Max	2.0 Max	2.0 Max	2.0 Max
W	Tape Width	18.0 +1.0 / -0.5	18.0 +1.0 / -0.5	18.0 +1.0 / -0.5	18.0 +1.0 / -0.5
W₀	Hold Down Tape Width	12.0 +/- 0.3	12.0 +/- 0.3	12.0 +/- 0.3	12.0 +/- 0.3
W₁	Hole Position	9.0 +0.75 / -0.50	9.0 +0.75 / -0.50	9.0 +0.75 / -0.50	9.0 +0.75 / -0.50
W₂	Hold Down Tape Position	0.5 Max	0.5 Max	0.5 Max	0.5 Max
H	Height from Tape Center to Component Base	18.0 +2.0 / -0.0	18.0 +2.0 / -0.0	18.0 +2.0 / -0.0	18.0 +2.0 / -0.0
H₀	Seating Plane Height	16.0 +/- 0.5	16.0 +/- 0.5	16.0 +/- 0.5	16.0 +/- 0.5
H₁	Component Height	36.0 Max	40.0 Max	46.5 Max	46.5 Max
D₀	Feed Hole Diameter	4.0 +/- 0.2	4.0 +/- 0.2	4.0 +/- 0.2	4.0 +/- 0.2
t	Total Tape Thickness	0.7 +/- 0.2	0.7 +/- 0.2	0.7 +/- 0.2	0.7 +/- 0.2
U	Undercrimp Width	8.0 Max	8.0 Max	8.0 Max	8.0 Max
p	Component Alignment	3° Max	3° Max	3° Max	3° Max

Part Numbering System

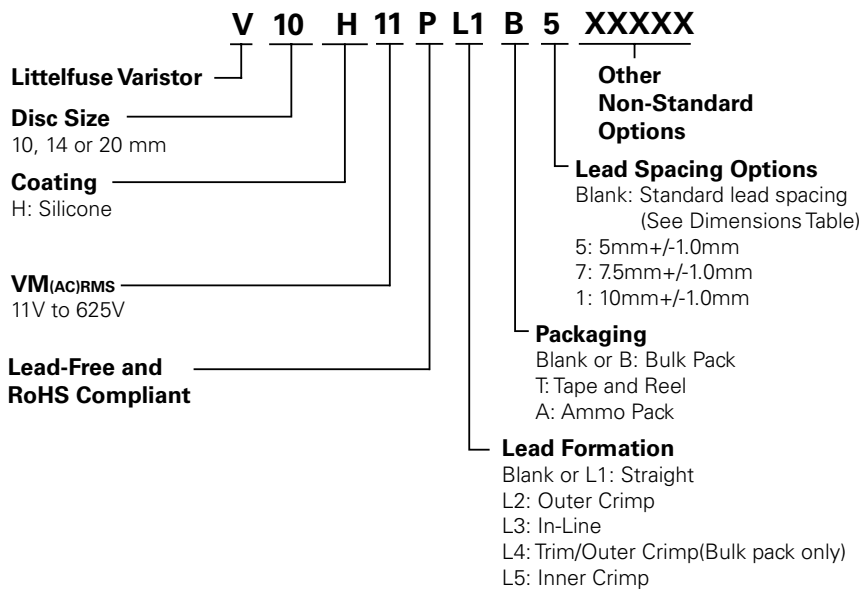

BA/BB Varistor Series



Agency Approvals

Agency	Agency Approval	Agency File Number
	UL1449	E320116 - for BA Series only.

Additional Information



**Datasheet
BA**



**Datasheet
BB**



**Resources
BA**



**Resources
BB**



**Samples
BA**



**Samples
BB**

Description

The BA and BB Series transient surge suppressors are heavy-duty industrial Metal-Oxide Varistors (MOVs) designed to provide surge protection for motor controls and power supplies used in oil-drilling, mining, transportation equipment and other heavy industrial AC line applications.

These varistors have similar package construction but differ in size and ratings. The BA models are rated from 130 to 880V_{M(AC)}. The BB models from 1100 to 2800V_{M(AC)}.

Both the BA and BB Series feature improved creep and strike capability to minimize breakdown along the package surface, a package design that provides complete electrical isolation of the disc subassembly, and rigid terminals to ensure secure wire contacts.

See BA/BB Series Device Ratings and Specifications Table for part number and brand information.

Features

- High energy absorption capability W_{TM}
BA Series 3200J
BB Series 10,000J
- Wide operating voltage range $V_{M(AC)RMS}$
BA Series 130V to 880V
BB Series 1100V to 2800V
- Rigid terminals for secure wire contact
- Case design provides complete electrical isolation of disc subassembly
- Littelfuse largest packaged disc 60mm diameter
- No derating up to 85°C ambient
- RoHS compliant

Absolute Maximum Ratings

• For ratings of individual members of a series, see Device Ratings and Specifications chart

Continuous	BA Series	BB Series	Units
Steady State Applied Voltage:			
AC Voltage Range ($V_{M(AC)RMS}$)	130 to 880	1100 to 2800	V
DC Voltage Range ($V_{M(DC)}$)	175 to 1150	1400 to 3500	V
Transients:			
Peak Pulse Current (I_{TM}) For 8/20 μ s Current Wave (See Figure 2)	50,000 to 70,000	70,000	A
Single Pulse Energy Range For 2ms Current Squarewave (W_{TM})	450 to 3200	3800 to 10000	J
Operating Ambient Temperature Range (T_A)	-55 to +85	-55 to +85	°C
Storage Temperature Range (T_{STG})	-55 to +125	-55 to +125	°C
Temperature Coefficient (α^V) of Clamping Voltage (V_C) at Specified Test Current	<0.01	<0.01	%/°C
Hi-Pot Encapsulation (COATING Isolation Voltage Capability) (Dielectric must withstand indicated DC voltage for one minute per MIL-STD-202, Method 301)	5000	5000	V
COATING Insulation Resistance	1000	1000	M Ω

CAUTION: Stresses above those listed in "Absolute Maximum Ratings" may cause permanent damage to the device. This is a stress only rating and operation of the device at these or any other conditions above those indicated in the operational sections of this specification is not implied.

BA/BB Series Ratings & Specifications

Part Number	Maximum Rating (85°C)				Specifications (25°C)				
	Continuous		Transient		Varistor Voltage at 1mA DC Test Current			Maximum Clamping Volt V_c at 200A Current (8/20 μ s)	Typical Capacitance $f = 1$ MHz
	V_{RMS}	V_{DC}	Energy (2ms)	Peak Current $8 \times 20\mu s$					
	$V_{M(AC)}$	$V_{M(DC)}$	W_{TM}	I_{TM}	Min	$V_{N(DC)}$	Max	V_c	C
(V)	(V)	(J)	(A)	(V)	(V)	(V)	(V)	(pF)	
BA Series									
V131BA60	130	175	450	50000	184.5	205	225.5	340	20000
V151BA60	150	200	530	50000	216	240	264	400	16000
V251BA60	250	330	880	50000	351	390	429	620	10000
V271BA60	275	369	950	50000	387	430	473	680	9000
V321BA60	320	420	1100	50000	459	510	561	760	7500
V421BA60	420	560	1500	70000	612	680	748	1060	6000
V481BA60	480	640	1600	70000	675	750	825	1160	5500
V511BA60	510	675	1800	70000	738	820	902	1300	5000
V571BA60	575	730	2100	70000	819	910	1001	1420	4500
V661BA60	660	850	2300	70000	945	1050	1155	1640	4000
V751BA60	750	970	2600	70000	1080	1200	1320	1880	3500
V881BA60	880	1150	3200	70000	1350	1500	1650	2340	2700
BB Series									
V112BB60	1100	1400	3800	70000	1665	1850	2035	2940	2200
V142BB60	1400	1750	5000	70000	2070	2300	2530	3600	1800
V172BB60	1700	2150	6000	70000	2500	2765	3030	4300	1500
V202BB60	2000	2500	7500	70000	2970	3300	3630	5200	1200
V242BB60	2400	3000	8600	70000	3510	3900	4290	6200	1000
V282BB60	2800	3500	10000	70000	4230	4700	5170	7400	800

NOTE: Average power dissipation of transients not to exceed 2.5W. See Figures 3 and 4 for more information on power dissipation.

Power Dissipation Ratings

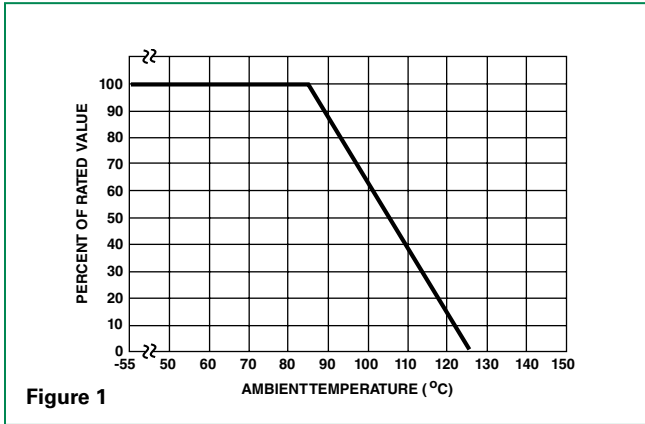

Figure 1

Should transients occur in rapid succession, the average power dissipation required is simply the energy (watt-seconds) per pulse times the number of pulses per second. The power so developed must be within the specifications shown on the Device Ratings and Characteristics Table for the specific device. Furthermore, the operating values need to be derated at high temperatures as shown in the above diagram. Because varistors can only dissipate a relatively small amount of average power they are, therefore, not suitable for repetitive applications that involve substantial amounts of average power dissipation.

Peak Pulse Current Test Waveform

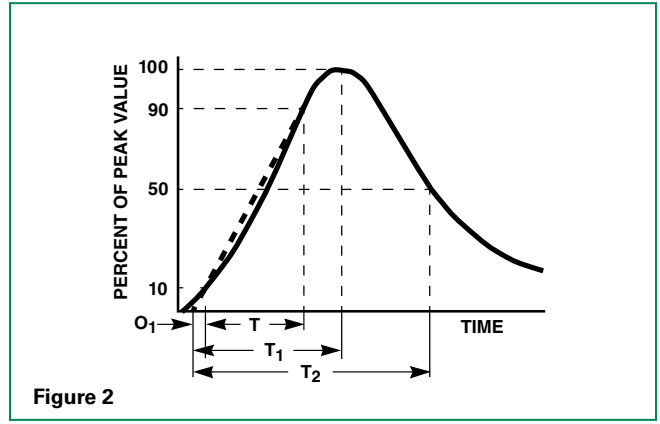

Figure 2

O_1 = Virtual Origin of Wave
 T = Time from 10% to 90% of Peak
 T_1 = Rise Time = $1.25 \times T$
 T_2 = Decay Time

Example - For an $8/20 \mu s$ Current Waveform:
 $8 \mu s = T_1$ = Rise Time
 $20 \mu s = T_2$ = Decay Time

Stand by Power Dissipation vs Applied V_{RMS} at Varied Temperatures

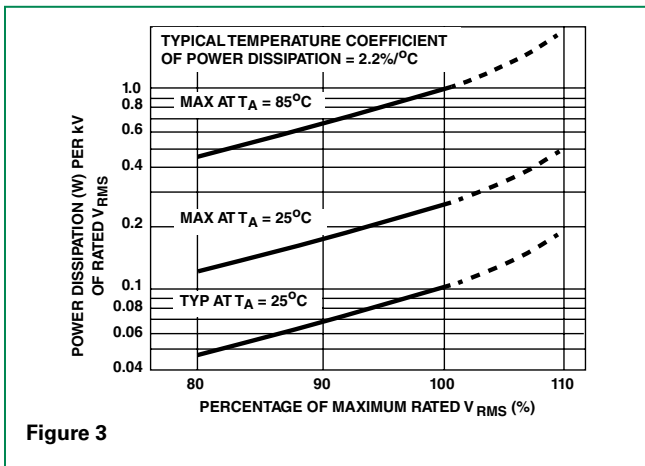

Figure 3

Typical Stability of Standby Power Dissipation at Rated V_{RMS} vs Time

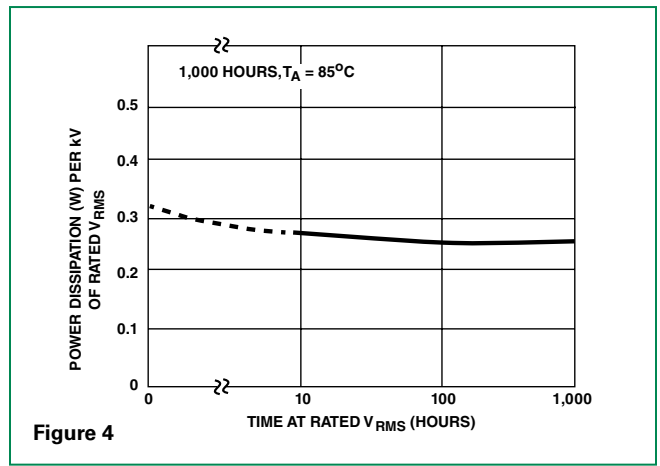

Figure 4

Maximum Clamping Voltage BA Series

V131BA60 - V881BA60

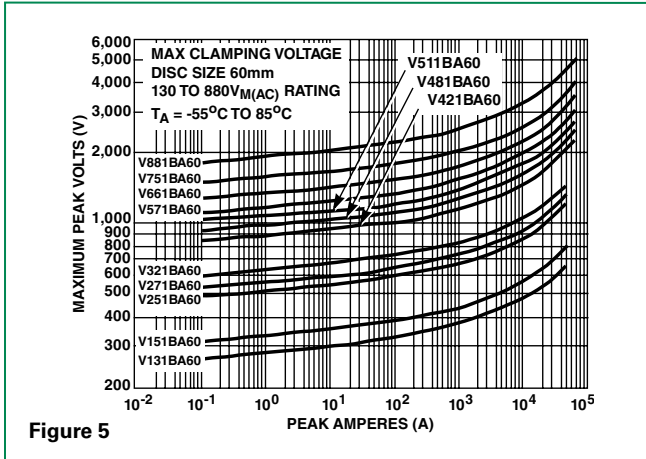

Figure 5

Maximum Clamping Voltage BB Series

V112BB60 - V282BB60

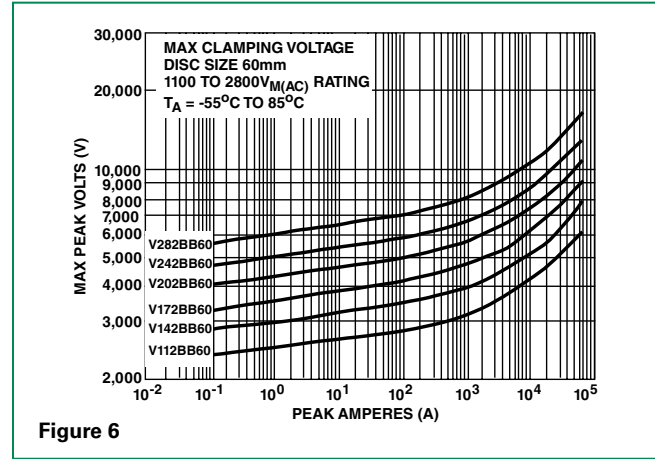

Figure 6

Repetitive Surge Capability BA Series

V131BA60 - V321BA60

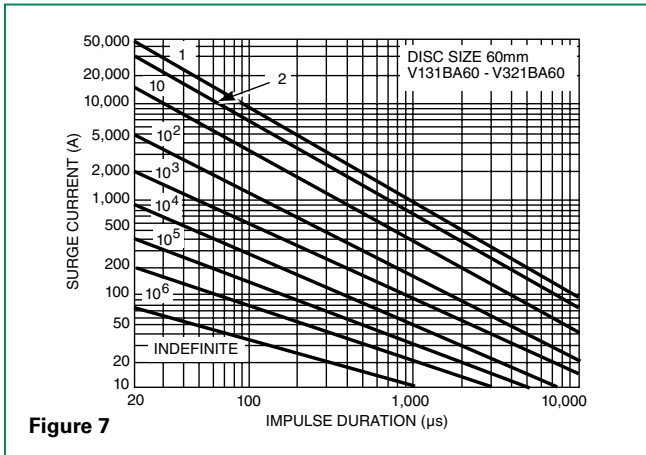

Figure 7

Repetitive Surge Capability BB Series

V421BA60 - V282BB60

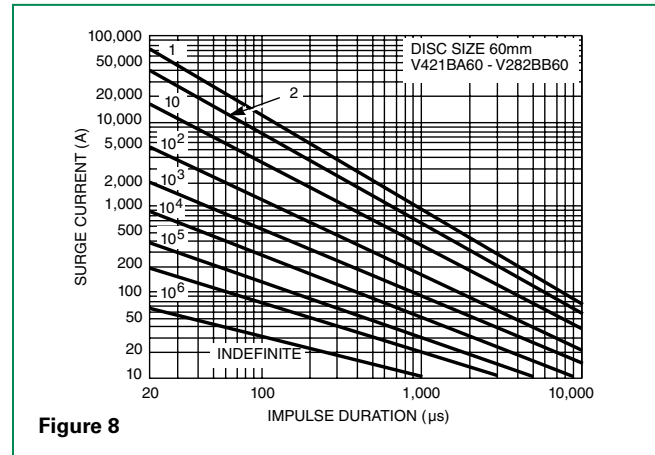

Figure 8

NOTE: If pulse ratings are exceeded, a shift of $V_{N(DC)}$ (at specified current) of more than +/-10% could result. This type of shift, which normally results in a decrease of $V_{N(DC)}$, may result in the device not meeting the original published specifications, but it does not prevent the device from continuing to function, and to provide ample protection.

Physical Specifications

Lead Material	BA / BB – Copper with Tin Plating
Insulating Material	Cured, flame retardant epoxy polymer meets UL94V-0 requirements.
Device Labeling	Marked with LF, Part Number and Date code

Environmental Specifications

Operating Temperature	-55°C to +85°C
Storage Temperature	-55°C to +125°C
Humidity Aging	+85°C, 85% RH, 1000 hours +/- 5% typical resistance change
Thermal Shock	+85°C to -40°C 10 times +/- 5% typical resistance change
Solvent Resistance	MIL-STD-202, Method 215
Moisture Sensitivity	Level 1, J-STD-020

Dimensions

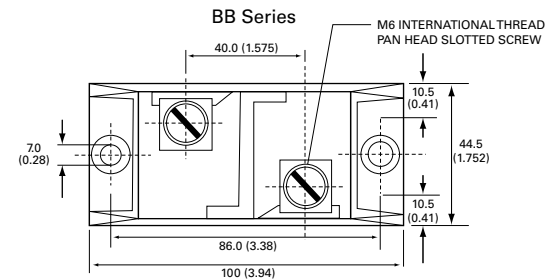
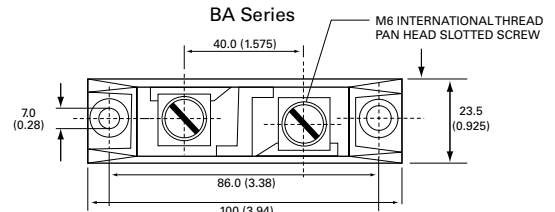
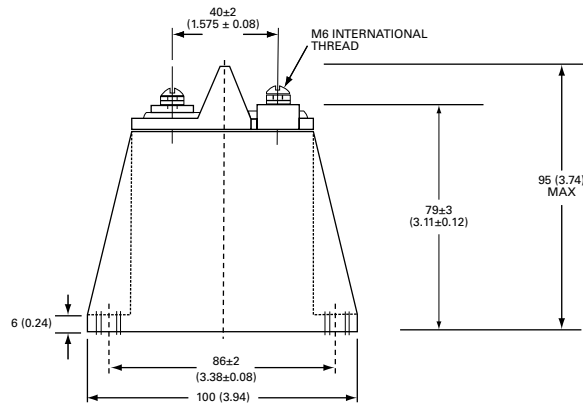

Notes:
 Typical weight: BA Series:250g and BB Series: 600g
 Dimensions are in mm; inches in parentheses for reference only.

Part Numbering System

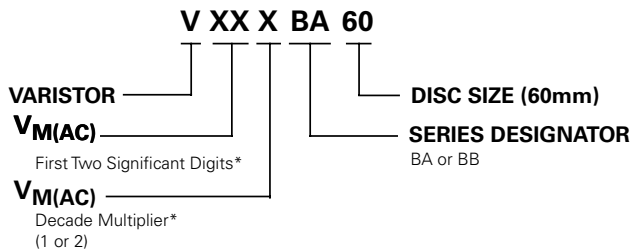

*Refer to Rating & Specifications table
 Examples:
 130 $V_{M(AC)}$ = 131
 2800 $V_{M(AC)}$ = 282

Disclaimer Notice - Information furnished is believed to be accurate and reliable. However, users should independently evaluate the suitability of and test each product selected for their own applications. Littelfuse products are not designed for, and may not be used in, all applications. Read complete Disclaimer Notice at www.littelfuse.com/disclaimer-electronics.

DA/DB Varistor Series



Description

The DA and DB Series transient surge suppressors are heavy-duty industrial Metal-Oxide Varistors (MOVs) designed to provide surge protection for motor controls and power supplies used in oil-drilling, mining, and transportation equipment.

These UL recognized varistors have identical ratings and specifications but differ in case construction to provide flexibility in equipment designs.

DA Series devices feature rigid terminals to ensure secure wire contacts. Both the DA and DB Series feature improved creep and strike distance capability to minimize breakdown along the package surface design that provides complete electrical isolation of the disc subassembly.

See DA/DB Series Device Ratings and Specifications table for part number and brand information.

Agency Approvals

Agency	Agency Approval	Agency File Number
	UL1449	E320116

Additional Information



Datasheet
DA



Resources
DA



Samples
DA



Datasheet
DB



Resources
DB



Samples
DB

Features

- High energy absorption capability W_{TM} up to 1050J
- Wide operating voltage range $V_{MIACIRMS}$ 130V to 750V
- Screw terminals (DA Series), quick connect push-on connectors (DB Series)
- Case design provides complete electrical isolation of disc subassembly
- 40mm diameter disc
- No derating up to 85°C ambient
- RoHS compliant

Absolute Maximum Ratings

• For ratings of individual members of a series, see Device Ratings and Specifications chart

Continuous	DA/DB Series	Units
Steady State Applied Voltage:		
AC Voltage Range ($V_{MIACIRMS}$)	130 to 750	V
DC Voltage Range (V_{MDC})	175 to 970	V
Transients:		
Peak Pulse Current (I_{TM})		
For 8/20 μ s Current Wave (See Figure 2)	40,000	A
Single Pulse Energy Range		
For 2ms Current Squarewave (W_{TM})	270 to 1050	J
Operating Ambient Temperature Range (T_A)	-55 to +85	°C
Storage Temperature Range (T_{STG})	-55 to +125	°C
Temperature Coefficient (α) of Clamping Voltage (V_C) at Specified Test Current	<0.01	%/°C
Hi-Pot Encapsulation (COATING Isolation Voltage Capability) (Dielectric must withstand indicated DC voltage for one minute per MIL-STD 202, Method 301)	5000	V
COATING Insulation Resistance	1000	M Ω

CAUTION: Stresses above those listed in "Absolute Maximum Ratings" may cause permanent damage to the device. This is a stress only rating and operation of the device at these or any other conditions above those indicated in the operational sections of this specification is not implied.

DA/DB Series Ratings & Specifications

Part Number Device Branding		Maximum Rating (85°C)				Specifications (25°C)				
		Continuous		Transient		Varistor Voltage at 1mA DC Test Current			Maximum Clamping Volt V_C at 200A Current (8/20 μ s)	Typical Capacitance $f =$ 1MHz
		V_{RMS}	V_{DC}	Energy (2ms)	Peak Current 8 x 20 μ s					
		$V_{M(AC)}$	$V_{M(DC)}$	W_{TM}	I_{TM}	Min	V_{NOM}	Max	V_C	C
DA	DB	(V)	(V)	(J)	(A)	(V)	(V)	(V)	(A)	(pF)
V131DA40	V131DB40	130	175	270	40000 ¹	184.5	205	225.5	345	10000
V151DA40	V151DB40	150	200	300	40000 ²	216	240	264	405	8000
V251DA40	V251DB40	250	330	370	40000	351	390	429	650	5000
V271DA40	V271DB40	275	369	400	40000	387	430	473	730	4500
V321DA40	V321DB40	320	420	460	40000	459	510	561	830	3800
V421DA40	V421DB40	420	560	600	40000	612	680	748	1130	3000
V481DA40	V481DB40	480	640	650	40000	675	750	825	1240	2700
V511DA40	V511DB40	510	675	700	40000	738	820	902	1350	2500
V571DA40	V571DB40	575	730	770	40000	819	910	1001	1480	2200
V661DA40	V661DB40	660	850	900	40000	945	1050	1155	1720	2000
V751DA40	V751DB40	750	970	1050	40000	1080	1200	1320	2000	1800

Note : Average power dissipation of transients not to exceed 2.0W.

Power Dissipation Ratings

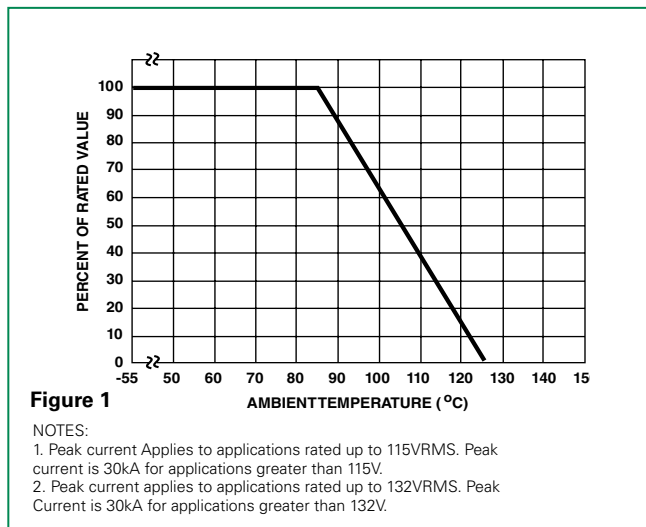

Should transients occur in rapid succession, the average power dissipation required is simply the energy (watt- seconds) per pulse times the number of pulses per second. The power so developed must be within the specifications shown on the Device Ratings and Specifications table for the specific device. Furthermore, the operating values need to be derated at high temperatures as shown above. Because varistors can only dissipate a relatively small amount of average power they are, therefore, not suitable for repetitive applications that involve substantial amounts of average power dissipation.

Peak Pulse Current Test Waveform

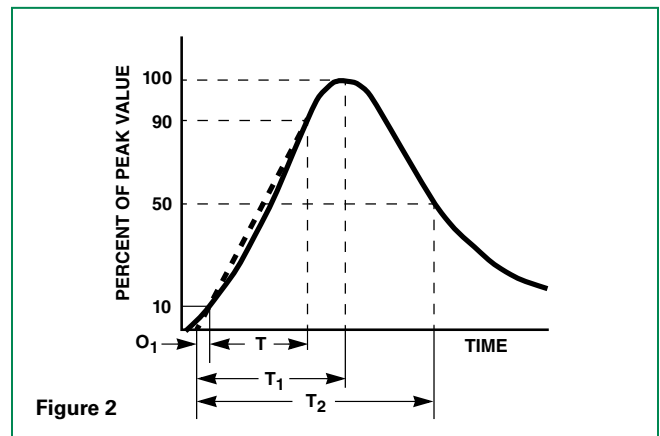

O_1 = Virtual Origin of Wave
 T = Time from 10% to 90% of Peak
 T_1 = Rise Time = 1.25 x T
 T_2 = Decay Time
Example - For an 8/20 μ s Current Waveform:
 8μ s = T_1 = Rise Time
 20μ s = T_2 = Decay Time

Maximum Clamping Voltage

V131DA40 - V751DA40 and V131DB40 - V751DB40

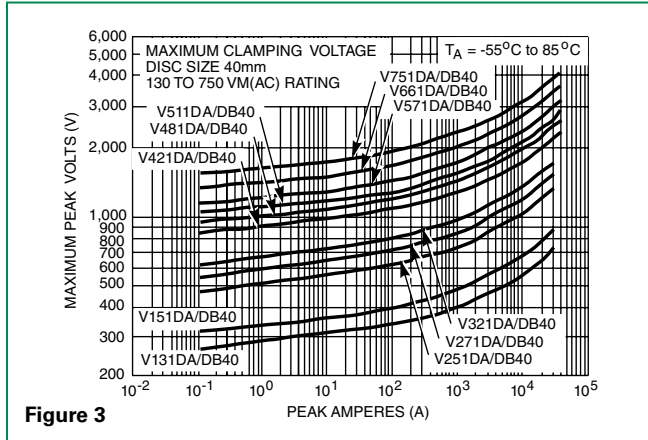

Figure 3

NOTE: If pulse ratings are exceeded, a shift of V_{NDCI} (at specified current) of more than +/-10% could result. This type of shift, which normally results in a decrease of V_{NDCI} , may result in the device not meeting the original published specifications, but it does not prevent the device from continuing to function, and to provide ample protection.

Physical Specifications

Lead Material	DA - Copper, Tin-plated DB - Brass, Tin-plated
Insulating Material	Cured, flame retardant epoxy polymer meets UL94V-0 requirements.
Device Labeling	Marked with LF, part number and date code

Repetitive Surge Capability

V131DA40 - V751DA40 and V131DB40 - V751DB40

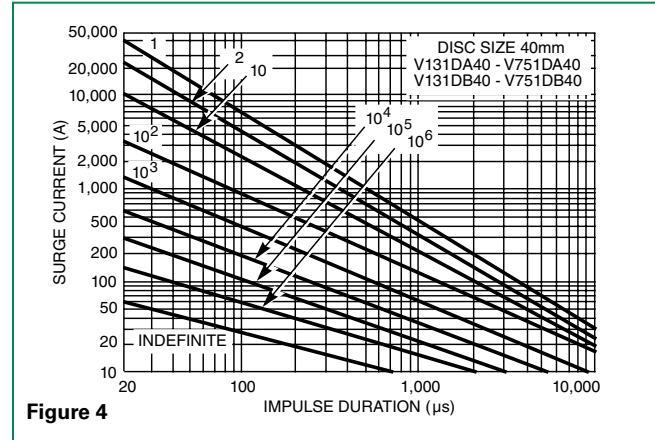
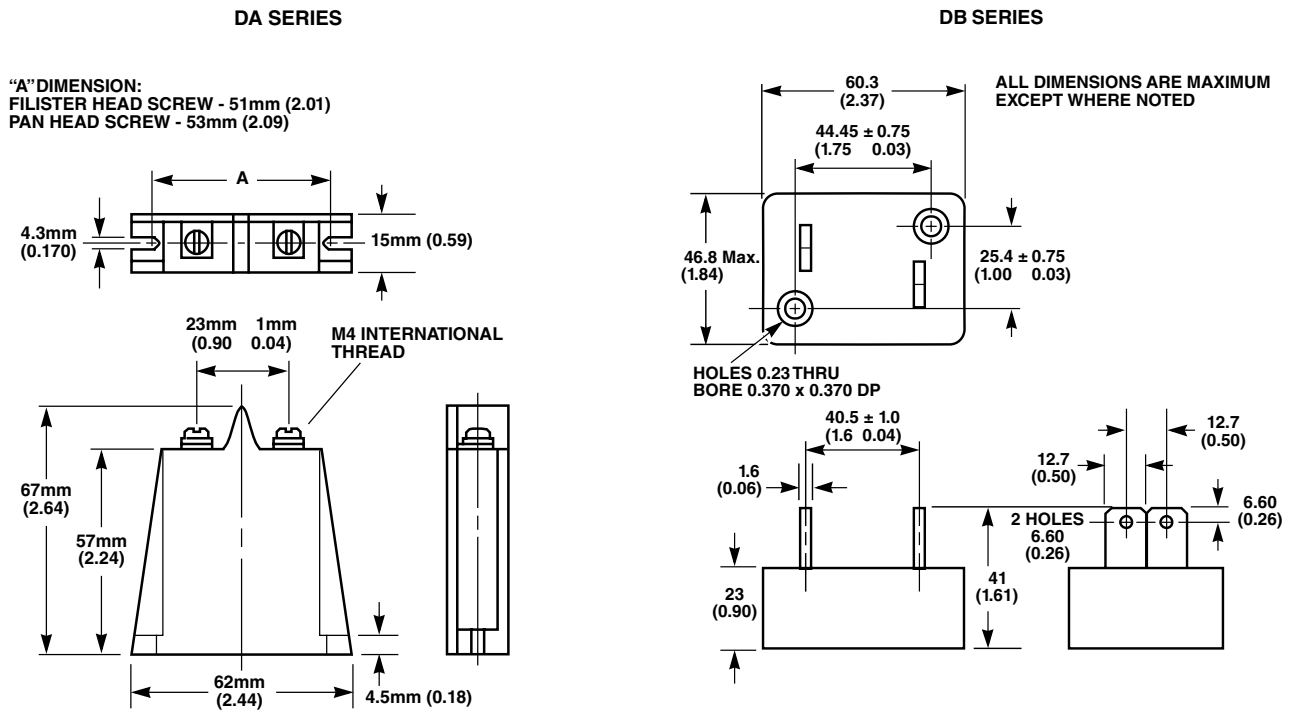

Figure 4

Environmental Specifications

Operating Temperature	-55°C to +85°C
Storage Temperature	-55°C to +125°C
Humidity Aging	+85°C, 85% RH, 1000 hours +/- 5% typical resistance change
Thermal Shock	+85°C to -40°C 10 times +/- 5% typical resistance change
Solvent Resistance	MIL-STD-202, Method 215
Moisture Sensitivity	Level 1, J-STD-020

Product Dimensions (mm)



Dimensions in millimeters and (inches).

Part Numbering System

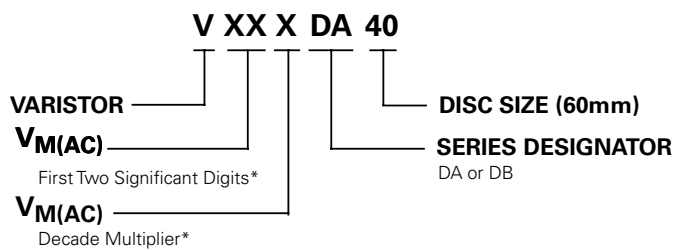



*Refer to Rating & Specifications table
 Example:
 130 V_{M(AC)} = 131

Disclaimer Notice - Information furnished is believed to be accurate and reliable. However, users should independently evaluate the suitability of and test each product selected for their own applications. Littelfuse products are not designed for, and may not be used in, all applications. Read complete Disclaimer Notice at www.littelfuse.com/disclaimer-electronics.

HA Varistor Series



Agency Approvals

Agency	Agency Approval	Agency File Number
	UL1449	E320116
	22.2-1	91788

Additional Information



Datasheet



Resources



Samples

Description

HA Series transient surge suppressors are industrial high energy Metal-Oxide Varistors (MOVs). They are designed to provide secondary surge protection in the outdoor and service entrance environment (distribution panels) of buildings, and also in industrial applications for motor controls and power supplies used in the oil-drilling, mining, and transportation fields.

The design of the HA Series of MOVs provide rigid terminals for screw mounting. Also available in a clipped lead version for through hole board placement or to accommodate soldered leads designation "HC."

See Ratings and Specifications Table for part number and brand information.

Features

- Lead-free, Halogen-Free and RoHS compliant.
- Wide operating voltage range
 $V_{M(AC)RMS}$
110V to 750V
- Two disc sizes available
32mm and 40mm
- High energy absorption capability
 $W_{TM} = 170J$ to 1050J
- High peak pulse current capability, $ITM = 25,000A$ to 40,000A
- Rigid terminals for secure mounting
- Available in trimmed version for through hole board mounting – Designation "HC"
- No derating up to 85°C ambient

Absolute Maximum Ratings

• For ratings of individual members of a series, see Device Ratings and Specifications chart

Continuous	HA Series	Units
Steady State Applied Voltage:		
AC Voltage Range ($V_{M(AC)RMS}$)	110 to 750	V
DC Voltage Range ($V_{M(DC)}$)	148 to 970	V
Transients:		
Peak Pulse Current (I_{TM})		
For 8/20 μ s Current Wave (See Figure 2)	25,000 to 40,000	A
Single Pulse Energy Range		
For 2ms Current Squarewave (W_{TM})	160 to 1050	J
Operating Ambient Temperature Range (T_A)	-55 to +85	°C
Storage Temperature Range (T_{STG})	-55 to +125	°C
Temperature Coefficient (α^V) of Clamping Voltage (V_C) at Specified Test Current	<0.01	%/°C
Hi-Pot Encapsulation (COATING Isolation Voltage Capability) (Dielectric must withstand indicated DC voltage for one minute per MIL-STD 202, Method 301)	2500	V
COATING Insulation Resistance	1000	M Ω

CAUTION: Stresses above those listed in "Absolute Maximum Ratings" may cause permanent damage to the device. This is a stress only rating and operation of the device at these or any other conditions above those indicated in the operational sections of this specification is not implied.

HA Series Ratings & Specifications

Part Number Device Branding	Maximum Rating (85°C)				Specifications (25°C)				
	Continuous		Transient		Varistor Voltage at 1mA DC Test Current			Maximum Clamping Volt V _C at 200A Current (8/20µs)	Typical Capacitance f = 1MHz
	V _{RMS}	V _{DC}	Energy (2ms)	Peak Current 8 x 20µs					
	V _{M(AC)}	V _{M(DC)}	W _{TM}	I _{TM}	Min	V _{N(DC)}	Max	V _C	C
	(V)	(V)	Energy	(A)	(V)	(V)	(V)	(A)	(pF)
V111HA32	110	148	160	25000	156	173	190	293	5450
V111HA40	110	148	220	40000 ¹	156	173	190	288	11600
V131HA32	130	175	200	25000	184.5	205	225.5	350	4700
V131HA40	130	175	270	40000 ²	184.5	205	225.5	345	10000
V141HA32	140	188	210	25000	198	220	242	380	4230
V141HA40	140	188	290	40000 ³	198	220	242	375	9000
V151HA32	150	200	220	25000	216	240	264	410	4000
V151HA40	150	200	300	40000 ⁴	216	240	264	405	8000
V181HA32	180	240	240	25000	254	282	310	475	3200
V181HA40	180	240	330	40000	254	282	310	468	6800
V201HA32	200	265	260	25000	283	314	345	540	3180
V201HA40	200	265	350	40000	283	314	345	533	6350
V251HA32	250	330	330	25000	351	390	429	650	2500
V251HA40	250	330	370	40000	351	390	429	630	5000
V271HA32	275	369	360	25000	387	430	473	710	2200
V271HA40	275	369	400	40000	387	430	473	690	4500
V301HA32	300	410	370	25000	423	470	517	795	2050
V301HA40	300	410	430	40000	423	470	517	780	4100
V321HA32	320	420	390	25000	459	510	561	845	1900
V321HA40	320	420	460	40000	459	510	561	825	3800
V331HA32	330	435	385	25000	467	518.5	570	860	1870
V331HA40	330	435	475	40000	467	518.5	570	843	3750
V351HA32	350	460	390	25000	495	549.5	604	910	1800
V351HA40	350	460	500	40000	495	549.5	604	894	3600
V391HA32	385	510	395	25000	545	604	663	1020	1750
V391HA40	385	510	550	40000	545	604	663	1000	3500
V421HA32	420	560	400	25000	612	680	748	1120	1500
V421HA40	420	560	600	40000	612	680	748	1100	3000
V441HA32	440	585	420	25000	622	690	758	1200	1450
V441HA40	440	585	630	40000	622	690	758	1147	2900
V481HA32	480	640	450	25000	675	750	825	1290	1300
V481HA40	480	640	650	40000	675	750	825	1230	2700
V511HA32	510	675	500	25000	738	820	902	1355	1200
V511HA40	510	675	700	40000	738	820	902	1295	2500
V551HA32	550	710	530	25000	778	863.5	949	1515	1190
V551HA40	550	710	755	40000	778	863.5	949	1430	2390
V571HA32	575	730	550	25000	819	910	1001	1570	1100
V571HA40	575	730	770	40000	819	910	1001	1480	2200
V661HA32	660	850	600	25000	945	1050	1155	1820	1000
V661HA40	660	850	900	40000	945	1050	1155	1720	2000
V681HA32	680	875	610	25000	962	1067.5	1173	1830	850
V681HA40	680	875	925	40000	962	1067.5	1173	1780	1900
V751HA32	750	970	700	25000	1080	1200	1320	2050	800
V751HA40	750	970	1050	40000	1080	1200	1320	2000	1800

NOTE: Average power dissipation of transients not to exceed 2.0W per varistor
 1. 40kA capability depends on applications rated up to 97Vrms. 30kA applies if > 97 Vrms.
 2. 40kA capability depends on applications rated up to 115Vrms. 30kA applies if > 115 Vrms.
 3. 40kA capability depends on applications rated up to 123Vrms. 30kA applies if > 123 Vrms.
 4. 40kA capability depends on applications rated up to 132Vrms. 30kA applies if > 132Vrms.

Power Dissipation Ratings

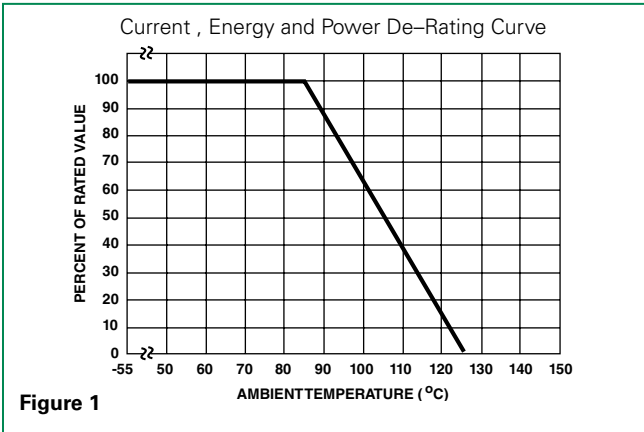

Figure 1

Should transients occur in rapid succession, the average power dissipation required is simply the energy (watt-seconds) per pulse times the number of pulses per second. The power so developed must be within the specifications shown on the Device Ratings and Specifications table for the specific device. Furthermore, the operating values need to be derated at high temperatures as shown in above. Because varistors can only dissipate a relatively small amount of average power they are, therefore, not suitable for repetitive applications that involve substantial amounts for average power dissipation.

Peak Pulse Current Test Waveform

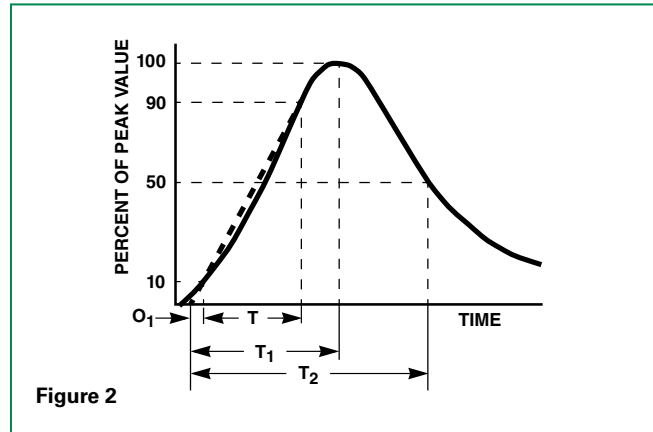

Figure 2

- O_1 = Virtual Origin of Wave
- T = Time from 10% to 90% of Peak
- T_1 = Rise Time = $1.25 \times T$
- T_2 = Decay Time

Example - For an $8/20 \mu s$ Current Waveform:

- $8 \mu s = T_1$ = Rise Time
- $20 \mu s = T_2$ = Decay Time

Maximum Clamping Voltage for 32mm Parts

V111HA32-V751HA32

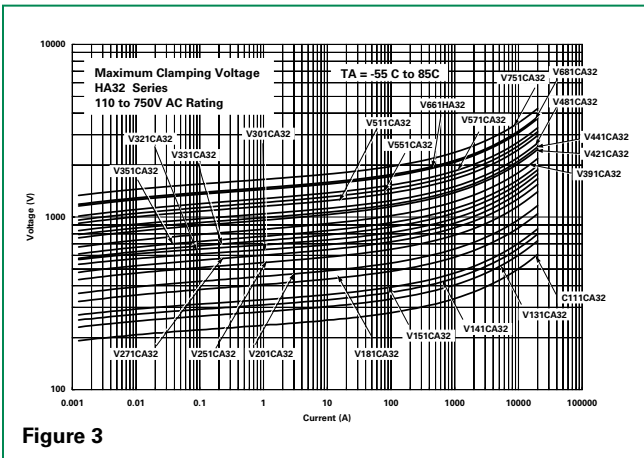

Figure 3

Maximum Clamping Voltage for 40mm Parts

V111HA40-V751HA40

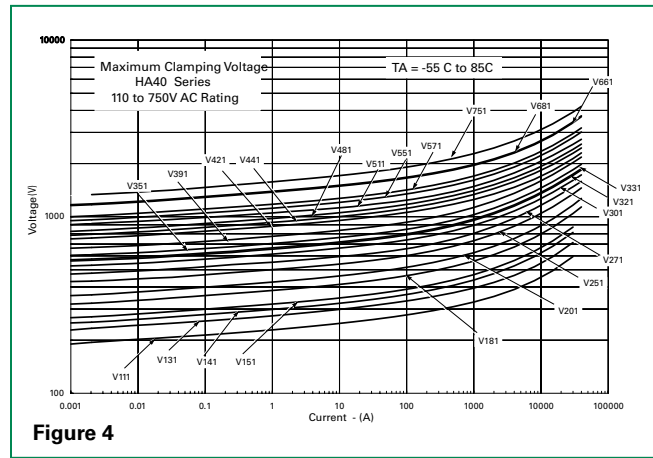

Figure 4

Repetitive Surge Capability for 32mm Parts

V111HA32 – V751HA32

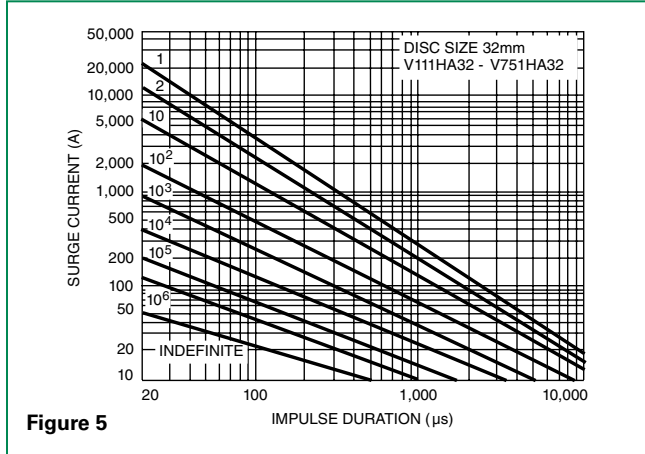

Figure 5

Repetitive Surge Capability for 40mm Parts

V111HA40 – V751HA40

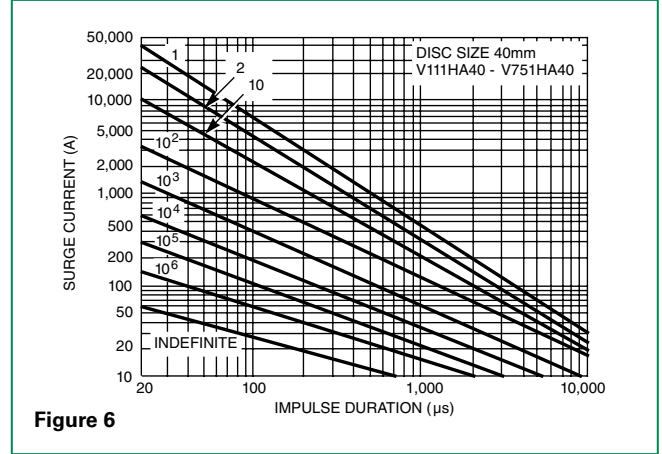

Figure 6

Wave Solder Profile

Non Lead-free Profile

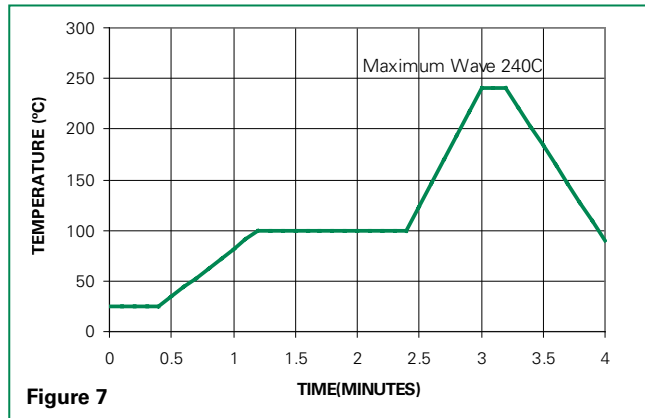

Figure 7

Lead-free Profile

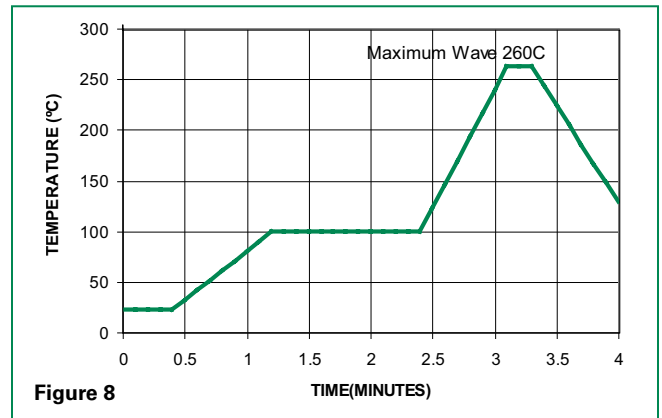

Figure 8

Physical Specifications

Lead Material	Tin-plated Copper
Soldering Characteristics	Solderability per MIL-STD-202, Method 208
Insulating Material	Cured, flame retardant epoxy polymer meets UL94V-0 requirements.
Device Labeling	LF, Part Number and date code

Environmental Specifications

Operating Temperature	-55°C to +85°C/
Storage Temperature	-55°C to +125°C
Humidity Aging	+85°C, 85% RH, 1000 hours +/- 10% typical resistance change
Thermal Shock	+85°C to -40°C 5 times +/- 10% typical resistance change
Solvent Resistance	MIL-STD-202, Method 215
Moisture Sensitivity	Level 1, J-STD-020

Dimensions

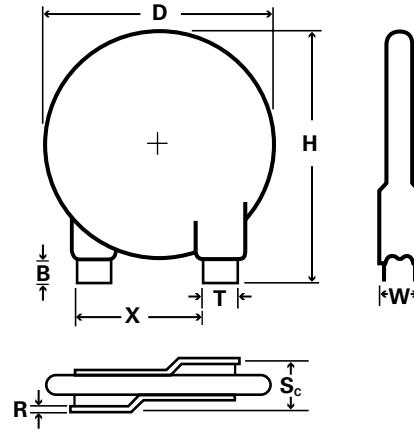
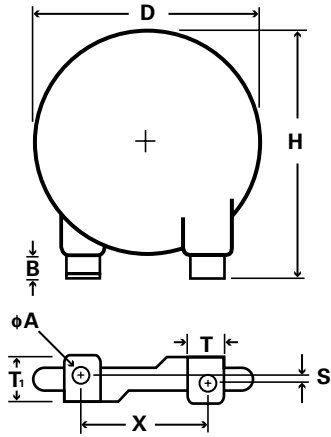

HA Series Outline Specifications

(Dimensions in Millimeters)

	D	H	B	X	T	T1	φA	s
	Max	Max	Min	Nom	Nom	Max	Max	Offset
HA32	35.5	50.00	3.0	25	9.3	10.4	4.2	Depends on Device Voltage (See Table Below)
HA40	42.5	57.00	3.0	25	9.3	10.4	4.2	

HC Series Outline Specifications

(Dimensions in Millimeters)

	D	H	B	X	T	R	s
	Max	Max	Min	Nom	Nom	Max	Offset
HC32	35.5	50.00	5.0	25	9.30	1.0	Depends on Device Voltage (See Table Below)
HC40	42.5	57.00	5.0	25	9.30	1.0	

HA Series Maximum Thickness and Terminal Offsets

(Dimensions in Millimeters)

Voltage	Thickness "W"		Dimension "S" (-/+1mm)	
	HA32	HA40	HA32	HA40
V111 - V351	9.00	9.00	3.90	3.90
V391 - V511	11.00	11.00	2.60	2.60
V551 - V751	13.00	13.00	1.00	1.00

HC Series Maximum Thickness and Terminal Offsets

(Dimensions in Millimeters)

Voltage	Thickness "W"		Dimension "S _c " (-/+1mm)	
	HC32	HC40	HC32	HC40
V111 - V351	9.00	9.00	6.00	6.00
V391 - V511	11.00	11.00	7.30	8.10
V551 - V751	13.00	13.00	8.90	10.00

Part Numbering System

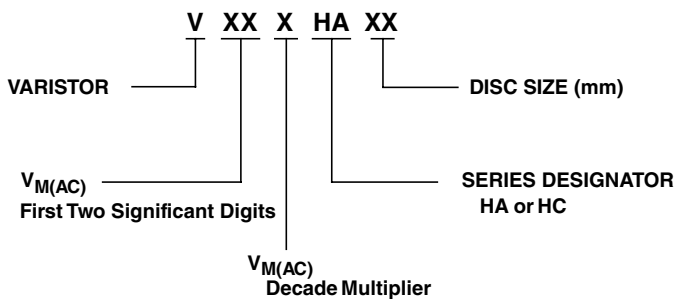

Disclaimer Notice - Information furnished is believed to be accurate and reliable. However, users should independently evaluate the suitability of and test each product selected for their own applications. Littelfuse products are not designed for, and may not be used in, all applications. Read complete Disclaimer Notice at www.littelfuse.com/disclaimer-electronics.

HB34, HF34 and HG34 Varistor Series



Agency Approvals

Agency	Agency Approval	Agency File Number
	UL1449	E320116
	22.2-1	91788

Absolute Maximum Ratings

• For ratings of individual members of a series, see Device Ratings and Specifications chart

Continuous	Hx34 Series	Units
Steady State Applied Voltage:		
AC Voltage Range ($V_{M(AC)RMS}$)	110 to 750	V
DC Voltage Range ($V_{M(DC)}$)	148 to 970	V
Transients:		
Peak Pulse Current (I_{TM})		
For 8/20 μ s Current Wave (See Figure 2)	40000	A
Single Pulse Energy Range		
For 2ms Current Wave (W_{TM})	220 to 1050	J
Operating Ambient Temperature Range (T_A)	-55 to +85	°C
Storage Temperature Range (T_{STG})	-55 to +125	°C
Temperature Coefficient (a^v) of Clamping Voltage (V_C) at Specified Test Current	<0.01	%/°C
Hi-Pot Encapsulation (COATING Isolation Voltage Capability) (Dielectric must withstand indicated DC voltage for one minute per MIL-STD 202, Method 301)	2500	V
COATING Insulation Resistance	1000	M Ω

CAUTION: Stresses above those listed in "Absolute Maximum Ratings" may cause permanent damage to the device. This is a stress only rating and operation of the device at these or any other conditions above those indicated in the operational sections of this specification is not implied.

Description

The HB34, HF34, and HG34 Series of transient surge suppressors are industrial high-energy Metal-Oxide Varistors (MOVs). They are designed to provide surge suppression in the AC mains outdoor and service entrance environment (distribution panels) of buildings. Applications also include industrial heavy motors, controls, and power supplies such as used in the oil-drilling, mining, and transportation fields, including HVAC and motor/generator applications.

The HB34 Series provides rigid terminals for through-hole solder mounting on printed circuit boards, thereby eliminating the need for screw mounting. The HF34 Series has the same rigid through-hole terminals as the HB34 with the addition of mounting holes for bolt-down mounting and longer terminals to allow for additional mounting flexibility. The HG34 has formed feet with mounting holes for vertical bolt-down mounting.

See Ratings and Specifications table for part numbers.

Features

- Lead-Free, Halogen-Free and RoHS Compliant available
- High peak pulse current capability $I_{TM} = 40,000A$
- Wide operating voltage range $V_{M(AC)RMS} = 110V$ to 750V
- Rigid terminals for secure through-hole solder mounting
- High energy absorption capability $W_{TM} = 220J$ to 1050J
- No derating up to 85°C ambient

Additional Information



**Datasheet
HB34**



**Datasheet
HF34**



**Datasheet
HG34**



**Resources
HB34**



**Resources
HF34**



**Resources
HG34**



**Samples
HB34**



**Samples
HF34**



**Samples
HG34**

HB34 Series Ratings & Specifications

Lead-free and RoHS Compliant Models	Model Size Disc Dia. (mm)	Maximum Rating (85°C)				Specifications (25°C)				
		Continuous		Transient		Varistor Voltage at 1mA DC Test Current			Maximum Clamping Voltage V_c at 200A Current (8/20 μ s)	Typical Capacitance
		V_{RMS}	V_{DC}	Energy (2ms)	Peak Current 8 x 20 μ s					
		$V_{M(AC)}$	$V_{M(DC)}$	W_{TM}	I_{TM}	Min	$V_{N(DC)}$	Max	V_c	$f = 1\text{MHz}$
Part Number		(V)	(V)	(J)	(A)	(V)	(V)	(V)	(V)	(pF)
V111HB34	34	110	148	220	40,000 ¹	156	173	190	288	11,600
V131HB34	34	130	175	270	40,000 ²	184.5	205	225.5	345	10,000
V141HB34	34	140	188	291	40,000 ³	198	220	242	375	9,000
V151HB34	34	150	200	300	40,000 ⁴	216	240	264	405	8,000
V181HB34	34	180	240	330	40,000	254	282	310	468	6,800
V201HB34	34	200	265	350	40,000	283	314	345	533	6,350
V251HB34	34	250	330	370	40,000	351	390	429	650	5,000
V271HB34	34	275	370	400	40,000	387	430	473	730	4,500
V301HB34	34	300	410	430	40,000	423	470	517	780	4,100
V321HB34	34	320	420	460	40,000	459	510	561	830	3,800
V331HB34	34	330	435	475	40,000	467	518.5	570	843	3,750
V351HB34	34	350	460	500	40,000	495	549.5	604	894	3,600
V391HB34	34	385	510	550	40,000	545	604	663	1000	3,500
V421HB34	34	420	560	600	40,000	612	680	748	1,130	3,000
V441HB34	34	440	587	620	40,000	622	690	758	1,150	2,900
V481HB34	34	480	640	650	40,000	675	750	825	1,240	2,700
V511HB34	34	510	675	700	40,000	738	820	902	1,350	2,500
V551HB34	34	550	710	755	40,000	778	863.5	949	1,404	2,390
V571HB34	34	570	730	770	40,000	819	910	1001	1,480	2,200
V661HB34	34	660	850	900	40,000	945	1050	1155	1,720	2,000
V681HB34	34	680	875	925	40,000	962	1067.5	1173	1,777	1,900
V751HB34	34	750	970	1050	40,000	1080	1200	1320	2,000	1,800

NOTE: Average power dissipation of transients not to exceed 2.0W.

1. Peak current applies to applications rated up to 97V_{RMS}. Peak current is 30kA for applications greater than 97V.
2. Peak current applies to applications rated up to 115V_{RMS}. Peak current is 30kA for applications greater than 115V.
3. Peak current applies to applications rated up to 123V_{RMS}. Peak current is 30kA for applications greater than 123V.
4. Peak current applies to applications rated up to 132V_{RMS}. Peak current is 30kA for applications greater than 132V.

HF34 Series Ratings & Specifications

Lead-free and RoHS Compliant Models	Model Size Disc Dia. (mm)	Maximum Rating (85°C)				Specifications (25°C)				
		Continuous		Transient		Varistor Voltage at 1mA DC Test Current			Maximum Clamping Voltage V_C at 200A Current (8/20 μ s)	Typical Capacitance
		V_{RMS}	V_{DC}	Energy (2ms)	Peak Current (8 x 20 μ s)					
		Part Number	$V_{M(AC)}$	$V_{M(DC)}$	W_{TM}	I_{TM}	Min	$V_{N(DC)}$	Max	V_C
	(V)	(V)	(J)	(A)	(V)	(V)	(V)	(V)	(pF)	
V111HF34	34	110	148	220	40,000 ¹	156	173	190	288	11,600
V131HF34	34	130	175	270	40,000 ²	184.5	205	225.5	345	10,000
V141HF34	34	140	188	291	40,000 ³	198	220	242	375	9,000
V151HF34	34	150	200	300	40,000 ⁴	216	240	264	405	8,000
V181HF34	34	180	240	330	40,000	254	282	310	468	6,800
V201HF34	34	200	265	350	40,000	283	314	345	533	6,350
V251HF34	34	250	330	370	40,000	351	390	429	650	5,000
V271HF34	34	275	370	400	40,000	387	430	473	730	4,500
V301HF34	34	300	410	430	40,000	423	470	517	780	4,100
V321HF34	34	320	420	460	40,000	459	510	561	830	3,800
V331HF34	34	330	435	475	40,000	467	518.5	570	843	3,750
V351HF34	34	350	460	500	40,000	495	549.5	604	894	3,600
V391HF34	34	385	510	550	40,000	545	604	663	1,000	3,500
V421HF34	34	420	560	600	40,000	612	680	748	1,130	3,000
V441HF34	34	440	587	620	40,000	622	690	758	1,150	2,900
V481HF34	34	480	640	650	40,000	675	750	825	1,240	2,700
V511HF34	34	510	675	700	40,000	738	820	902	1,350	2,500
V551HF34	34	550	710	755	40,000	778	863.5	949	1,404	2,390
V571HF34	34	570	730	770	40,000	819	910	1001	1,480	2,200
V661HF34	34	660	850	900	40,000	945	1050	1155	1,720	2,000
V681HF34	34	680	875	925	40,000	962	1067.5	1173	1777	1,900
V751HF34	34	750	970	1050	40,000	1080	1200	1320	2,000	1,800

Note:

1. Peak current applies to applications rated up to 97 V_{RMS} . Peak current is 30kA for applications greater than 97V.
2. Peak current applies to applications rated up to V_{RMS} . Peak current is 30kA for applications greater than 115V.
3. Peak current applies to applications rated up to V_{RMS} . Peak current is 30kA for applications greater than 123V.
4. Peak current applies to applications rated up to V_{RMS} . Peak current is 30kA for applications greater than 132V.

HG34 Series Ratings & Specifications

Lead-free and RoHS Compliant Models	Model Size Disc Dia. (mm)	Maximum Rating (85°C)				Specifications (25°C)				
		Continuous		Transient		Varistor Voltage at 1mA DC Test Current			Maximum Clamping Voltage V_C at 200A Current (8/20 μ s)	Typical Capacitance
		V_{RMS}	V_{DC}	Energy (2ms)	Peak Current 8 x 20 μ s					
		$V_{M(AC)}$	$V_{M(DC)}$	W_{TM}	I_{TM}	Min	$V_{N(DC)}$	Max	V_C	$f = 1\text{MHz}$
Part Number		(V)	(V)	(J)	(A)	(V)	(V)	(V)	(V)	(pF)
V111HG34	34	110	148	220	40,000 ¹	156	173	190	288	11,600
V131HG34	34	140	175	270	40,000 ²	184.5	205	225.5	345	10,000
V141HG34	34	130	188	291	40,000 ³	198	220	242	375	9,000
V151HG34	34	150	200	300	40,000 ⁴	216	240	264	405	8,000
V181HG34	34	180	240	330	40,000	254	282	310	468	6,800
V201HG34	34	200	265	350	40,000	283	314	345	533	6,350
V251HG34	34	250	330	370	40,000	351	390	429	650	5,000
V271HG34	34	275	370	400	40,000	387	430	473	730	4,500
V301HG34	34	300	410	430	40,000	423	470	517	780	4,100
V321HG34	34	320	420	460	40,000	459	510	561	830	3,800
V331HG34	34	330	435	475	40,000	467	518.5	570	843	3,750
V351HG34	34	350	460	500	40,000	495	549.5	604	894	3,600
V331HG34	34	385	510	550	40,000	545	604	663	1,000	3,500
V421HG34	34	420	560	600	40,000	612	680	748	1,130	3,000
V441HG34	34	440	587	620	40,000	622	690	758	1,150	2,900
V481HG34	34	480	640	650	40,000	675	750	825	1,240	2,700
V511HG34	34	510	675	700	40,000	738	820	902	1,350	2,500
V551HG34	34	550	710	755	40,000	778	863.5	949	1,404	2,390
V571HG34	34	570	730	770	40,000	819	910	1001	1,480	2,200
V661HG34	34	660	850	900	40,000	945	1050	1155	1,720	2,000
V681HG34	34	680	875	925	40,000	962	1067.5	1173	1,777	1,900
V751HG34	34	750	970	1050	40,000	1080	1200	1320	2,000	1,800

Note :

1. Peak current applies to applications rated up to $97V_{RMS}$. Peak current is 30kA for applications greater than 97V.
2. Peak current applies to applications rated up to $115V_{RMS}$. Peak current is 30kA for applications greater than 115V.
3. Peak current applies to applications rated up to $123V_{RMS}$. Peak current is 30kA for applications greater than 123V.
4. Peak current applies to applications rated up to $132V_{RMS}$. Peak current is 30kA for applications greater than 132V.

Power Dissipation Ratings

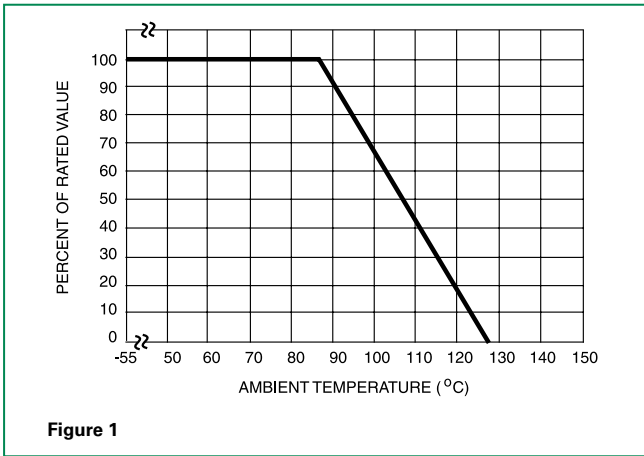

Should transients occur in rapid succession, the average power dissipation result is simply the energy (watt-seconds) per pulse times the number of pulses per second. The power so developed must be within the specifications shown on the Device Ratings and Specifications Table for the specific device. The operating values must be derated as shown in above.

Peak Pulse Current Test Waveform

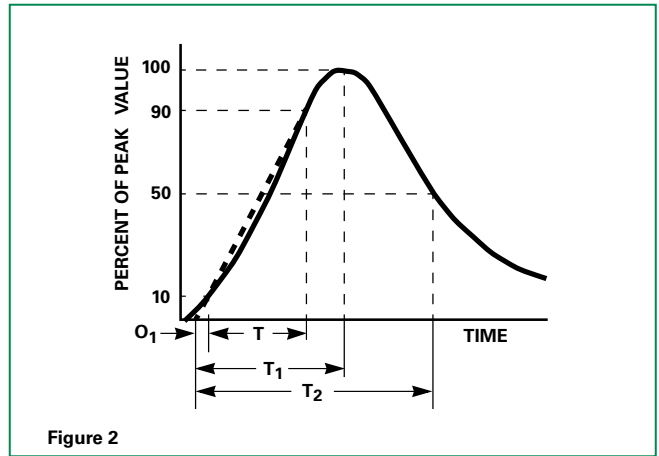

O_1 = Virtual Origin of Wave
 T = Time from 10% to 90% of Peak
 T_1 = Rise Time = $1.25 \times T$
 T_2 = Decay Time

Example - For an $8/20 \mu s$ Current Waveform:
 $8 \mu s = T_1 = \text{Rise Time}$
 $20 \mu s = T_2 = \text{Decay Time}$

Clamping Voltage for HB34, HF34 and HG34 Series

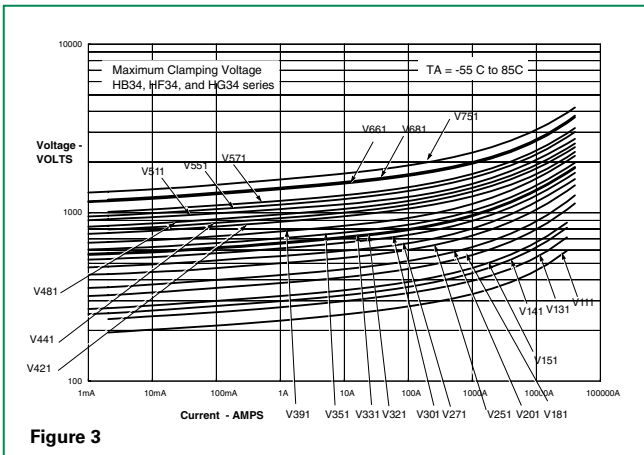

Surge Current Rating Curves for HB34, HF34 and HG34 Series

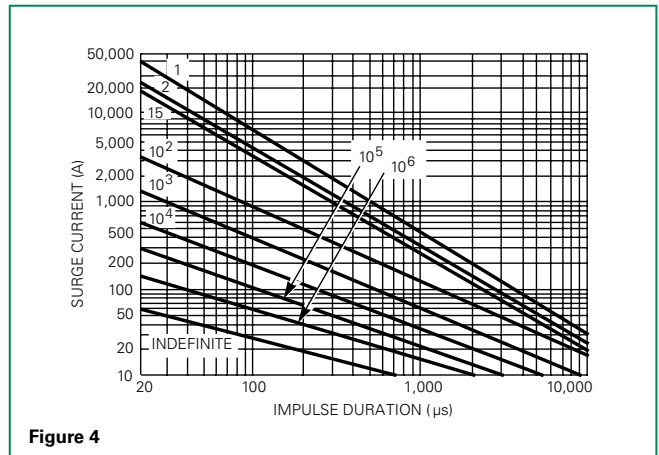

NOTE: If pulse ratings are exceeded, a shift of V_{NDC} (at specified current) of more than $\pm 10\%$ could result. This type of shift, which normally results in a decrease of V_{NDC} , may result in the device not meeting the original published specifications, but it does not prevent the device from continuing to function, and to provide ample protection.

Wave Solder Profile

Non Lead-free Profile

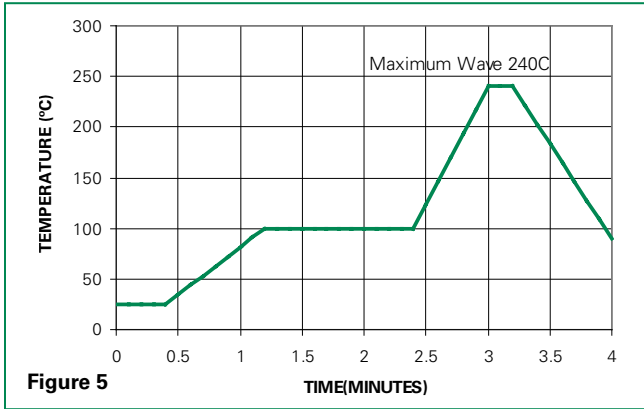

Figure 5

Lead-free Profile



Figure 6

Physical Specifications

Lead Material	Tin-plated Copper
Soldering Characteristics	Solderability per MIL-STD-202, Method 208
Insulating Material	Cured, flame retardant epoxy polymer meets UL94V-0 requirements.
Device Labeling	LF, Part Number and date code

Environmental Specifications

Operating Temperature	-55°C to +125°C
Storage Temperature	-55°C to +125°C
Humidity Aging	+85°C, 85% RH, 1000 hours +/-10% Voltage
Thermal Shock	+85°C to -40°C 5 times +/-10% Voltage
Solvent Resistance	MIL-STD-202, Method 215
Moisture Sensitivity	Level 1, J-STD-020

Dimensions (mm)

HB34 Series

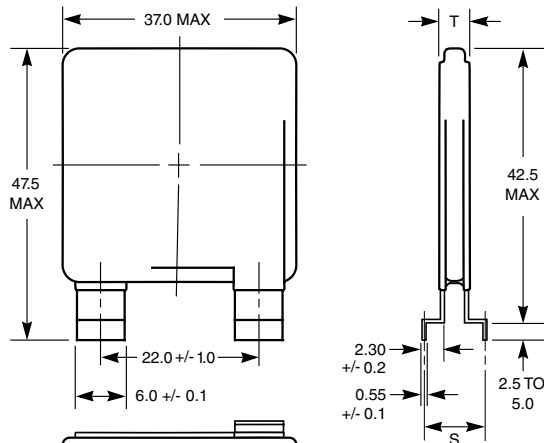

NOTE: Dimension in mm is typical, unless otherwise specified.

HB34 Series Thickness and Terminal Offset Dimensions

Part Type	T Body Thickness (Max)	S Mounting Terminal Offset
V111HB34	5.5	5.30 +/- 0.65
V131HB34	5.7	5.50 +/- 0.65
V141HB34	5.8	5.70 +/- 0.65
V151HB34	5.9	5.90 +/- 0.65
V181HB34	6.0	6.10 +/- 0.65
V201HB34	6.0	6.10 +/- 0.65
V251HB34	6.1	6.25 +/- 0.65
V271HB34	6.4	6.50 +/- 0.65
V301HB34	6.7	6.70 +/- 0.65
V321HB34	6.9	6.90 +/- 0.65
V331HB34	7.0	6.95 +/- 0.65
V351HB34	7.3	7.20 +/- 0.85
V391HB34	7.6	7.50 +/- 0.85
V421HB34	7.8	7.85 +/- 0.85
V441HB34	8.0	7.95 +/- 1.00
V481HB34	8.3	8.25 +/- 1.00
V511HB34	8.8	8.60 +/- 1.00
V551HB34	9.1	8.55 +/- 1.5
V571HB34	9.4	8.85 +/- 1.5
V661HB34	10.2	9.65 +/- 1.5
V681HB34	10.4	10.35 +/- 1.5
V751HB34	10.7	10.65 +/- 1.5

HF34 Series

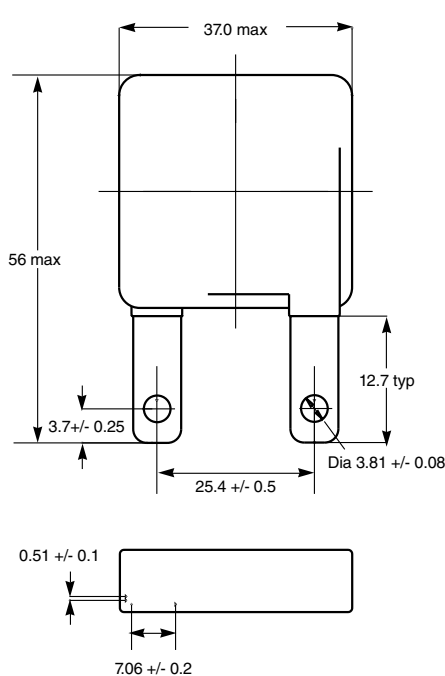

Note: Terminal Material Tin-plated Cover

HF34 Series Thickness and Terminal Offset Dimensions

Part Type	T Body Thickness (Max)	S Mounting Terminal Offset
V111HF34	5.5	2.0 +/- 0.65
V131HF34	5.7	2.1 +/- 0.65
V141HF34	5.8	2.2 +/- 0.65
V151HF34	5.9	2.4 +/- 0.65
V181HF34	6.0	2.5 +/- 0.65
V201HF34	6.0	2.6 +/- 0.65
V251HF34	6.1	2.7 +/- 0.85
V271HF34	6.4	2.9 +/- 0.85
V301HF34	6.7	3.2 +/- 0.85
V321HF34	6.9	3.4 +/- 0.85
V331HF34	7.0	3.5 +/- 0.85
V351HF34	7.3	3.9 +/- 0.85
V391HF34	7.6	4.2 +/- 0.85
V421HF34	7.8	4.4 +/- 0.85
V441HF34	8.0	4.5 +/- 0.85
V481HF34	8.3	4.8 +/- 1.0
V511HF34	8.8	5.2 +/- 1.0
V551HF34	9.1	5.5 +/- 1.0
V571HF34	9.4	5.7 +/- 1.5
V661HF34	10.2	6.5 +/- 1.5
V681HF34	10.4	6.7 +/- 1.5
V751HF34	10.7	7.3 +/- 1.5

Dimensions (mm)

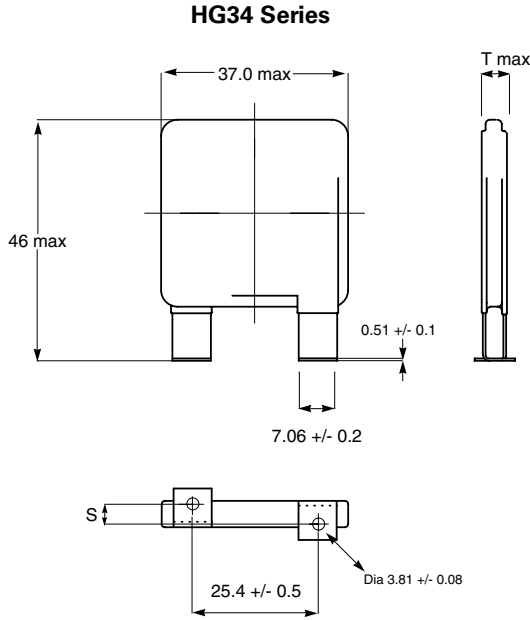

Note: Terminal Material Tin-plated Cover

HG34 Series Thickness and Terminal Offset Dimensions

Part Type	T Body Thickness (Max)	S Mounting Terminal Offset
V111HG34	5.5	6.0 -/+ 0.65
V131HG34	5.7	5.8 -/+ 0.65
V141HG34	5.8	5.6 -/+ 0.65
V151HG34	5.9	5.5 -/+ 0.65
V181HG34	6.0	5.4 -/+ 0.65
V201HG34	6.0	5.4 -/+ 0.65
V251HG34	6.1	5.2 -/+ 0.65
V271HG34	6.4	4.9 -/+ 0.65
V301HG34	6.7	4.7 -/+ 0.85
V321HG34	6.9	4.5 -/+ 0.85
V331HG34	7.0	4.4 -/+ 0.85
V351HG34	7.3	4.1 -/+ 0.85
V391HG34	7.6	3.8 -/+ 0.85
V421HG34	7.8	3.5 -/+ 0.85
V441HG34	8.0	3.3 -/+ 0.85
V481HG34	8.3	3.1 -/+ 1.0
V511HG34	8.8	2.7 -/+ 1.0
V551HG34	9.1	2.4 -/+ 1.0
V571HG34	9.4	2.2 -/+ 1.5
V661HG34	10.2	1.4 -/+ 1.5
V681HG34	10.4	1.2 -/+ 1.5
V751HG34	10.7	0.6 -/+ 1.5

*Dimensions in mm.

Part Numbering System

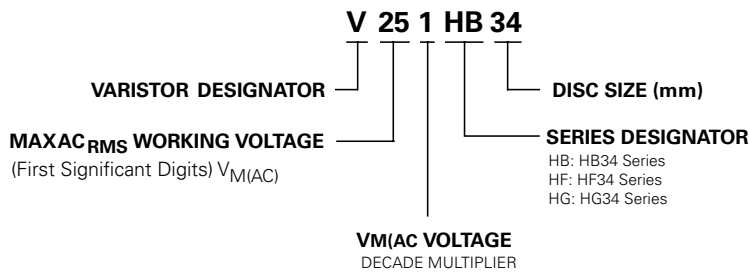

Disclaimer Notice - Information furnished is believed to be accurate and reliable. However, users should independently evaluate the suitability of and test each product selected for their own applications. Littelfuse products are not designed for, and may not be used in, all applications. Read complete Disclaimer Notice at www.littelfuse.com/disclaimer-electronics.

DHB34 Varistor Series



Agency Approvals

Agency	Agency Approval	Agency File Number
	UL1449	E320116
	22.2-1	91788

Additional Information



Datasheet



Resources



Samples

Description

The DHB34 Series of transient surge suppressors is comprised of two industrial high-energy Metal-Oxide Varistors (MOV) discs placed in parallel as a single device. They are designed to provide surge suppression in the AC mains outdoor and service entrance environment (distribution panels) of buildings. DHB34 applications also include industrial heavy motors, controls, and power supplies such as used in the oil-drilling, mining, and transportation fields, including HVAC and motor/generator applications.

The DHB34 Series provides rigid terminals for through-hole solder mounting on printed circuit boards, thereby eliminating the need for screw mounting.

Features

- Lead-Free, Halogen-Free and RoHS Compliant
- Wide operating voltage range
 $V_{M(AC)RMS}$ 110V to 750V
- High-energy absorption capability
 $W_{TM} = 220J$ to 1050J
- High peak pulse current (Each of two discs placed in parallel) capability
 $I_{TM} = 40,000A$
- Rigid terminals for secure through-hole solder mounting
- No derating up to 85°C ambient
- Dual Disc Device - two 34mm varistor discs in parallel in a single package.

Absolute Maximum Ratings

• For ratings of individual members of a series, see Device Ratings and Specifications chart

Continuous	DHB34 Series	Units
Steady State Applied Voltage:		
AC Voltage Range ($V_{M(AC)RMS}$)	110 to 750	V
DC Voltage Range ($V_{M(DC)}$)	148 to 970	V
Transients:		
Peak Pulse Current (I_{TM})		
For 8/20 μ s Current Wave (See Figure 2)	40000	A
Single Pulse Energy Range		
For 2ms Current Wave (W_{TM})	220 to 1050	J
Operating Ambient Temperature Range (T_A)	-55 to + 85	°C
Storage Temperature Range (T_{STG})	-55 to + 125	°C
Temperature Coefficient (α^V) of Clamping Voltage (V_C) at Specified Test Current	<0.01	%/°C
Hi-Pot Encapsulation (COATING Isolation Voltage Capability)	2500	V
COATING Insulation Resistance	1000	M Ω

CAUTION: Stresses above those listed in "Absolute Maximum Ratings" may cause permanent damage to the device. This is a stress only rating and operation of the device at these or any other conditions above those indicated in the operational sections of this specification is not implied.

DHB34 Series Ratings & Specifications

Lead-free and RoHS Compliant Models	Model Size Disc Dia. (mm)	Maximum Rating (85°C)				Specifications (25°C)				
		Continuous		Transient		Varistor Voltage at 1mA DC Test Current			Maximum Clamping Voltage V_C at 200A Current (8/20 μ s)	Typical Capacitance
		V_{RMS}	V_{DC}	Energy (2ms)	Peak Current (8 x 20 μ s)					
		$V_{M(AC)}$	$V_{M(DC)}$	W_{TM}	I_{TM}	Min	$V_{N(DC)}$	Max	V_C	$f = 1\text{MHz}$
Part Number		(V)	(V)	(J)	(A)	(V)	(V)	(V)	(V)	(pF)
V111DHB34	34	110	148	220	40,000 ¹	156	173	190	288	11,600
V131DHB34	34	130	175	270	40,000 ²	184.5	205	225.5	345	10,000
V141DHB34	34	140	188	291	40,000 ³	198	220	242	375	9,000
V151DHB34	34	150	200	300	40,000 ⁴	216	240	264	405	8,000
V181DHB34	34	180	240	330	40,000	254	282	310	468	6,800
V201DHB34	34	200	265	350	40,000	283	314	345	533	6,350
V251DHB34	34	250	330	370	40,000	351	390	429	650	5,000
V271DHB34	34	275	369	400	40,000	387	430	473	730	4,500
V301DHB34	34	300	410	430	40,000	423	470	517	780	4,100
V321DHB34	34	320	420	460	40,000	459	510	561	830	3,800
V331DHB34	34	330	435	475	40,000	467	518.5	570	843	3,750
V351DHB34	34	350	460	500	40,000	495	549.5	604	894	3,600
V391DHB34	34	385	510	550	40,000	545	604	663	1,000	3,500
V421DHB34	34	420	560	600	40,000	612	680	748	1,130	3,000
V441DHB34	34	440	585	630	40,000	622	690	758	1,147	2,900
V481DHB34	34	480	640	650	40,000	675	750	825	1,240	2,700
V511DHB34	34	510	675	700	40,000	738	820	902	1,350	2,500
V551DHB34	34	550	710	755	40,000	778	863.5	949	1,404	2,390
V571DHB34	34	575	730	770	40,000	819	910	1001	1,480	2,200
V661DHB34	34	660	850	900	40,000	945	1050	1155	1,720	2,000
V681DHB34	34	680	875	925	40,000	962	1067.5	1173	1,777	1,900
V751DHB34	34	750	970	1050	40,000	1080	1200	1320	2,000	1,800

Note:

- 40kA capability depends on applications rated up to 97 V_{RMS} . 30kA applies if > 97 V_{RMS} .
- 40kA capability depends on applications rated up to 115 V_{RMS} . 30kA applies if > 115 V_{RMS} .
- 40kA capability depends on applications rated up to 123 V_{RMS} . 30kA applies if > 123 V_{RMS} .
- 40kA capability depends on applications rated up to 132 V_{RMS} . 30kA applies if > 132 V_{RMS} .

Power Dissipation Ratings

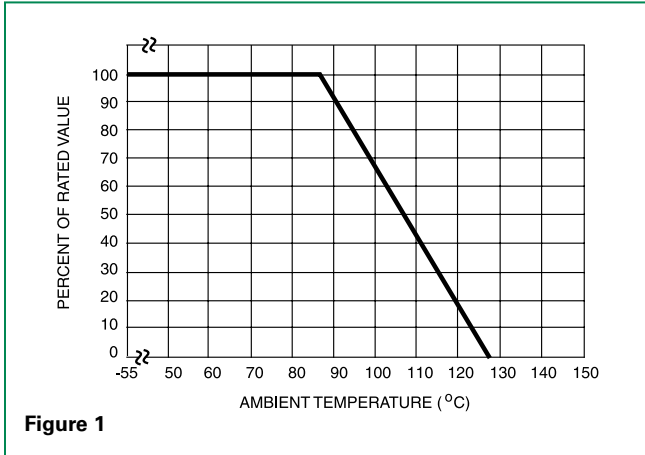

Should transients occur in rapid succession, the average power 100 dissipation result is simply the energy (watt-seconds) per pulse times the number of pulses per second. The power so developed must be within the specifications shown on the Device Ratings and Specifications table for the specific device. The operating values must be derated as shown in above.

Peak Pulse Current Test Waveform

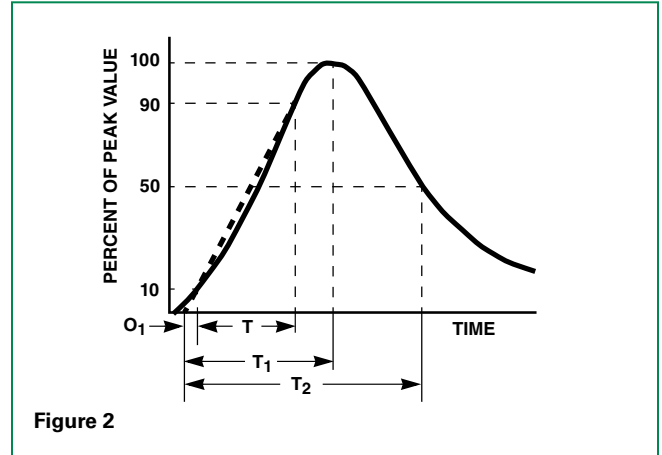

O_1 = Virtual Origin of Wave
 T = Time from 10% to 90% of Peak
 T_1 = Rise Time = $1.25 \times T$
 T_2 = Decay Time
Example - For an $8/20 \mu s$ Current Waveform:
 $8 \mu s = T_1$ = Rise Time
 $20 \mu s = T_2$ = Decay Time

Maximum Clamping Voltage

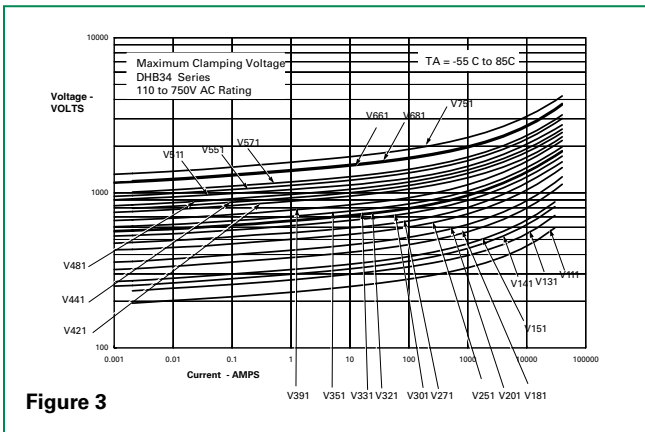

Repetitive Surge Capability

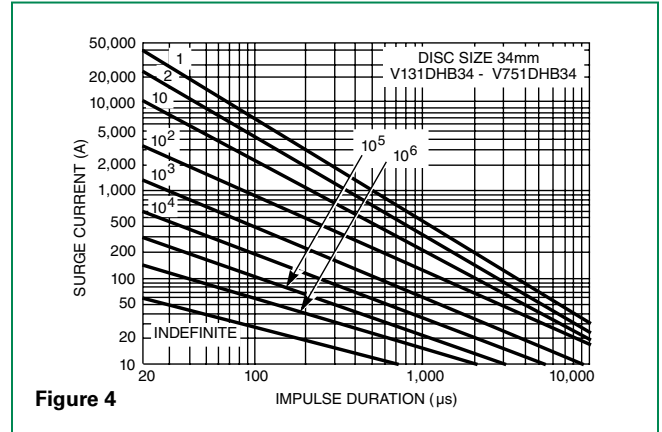

NOTE: If pulse ratings are exceeded, a shift of V_{NIDC} (at specified current) of more than $\pm 10\%$ could result. This type of shift, which normally results in a decrease of V_{NIDC} , may result in the device not meeting the original published specifications, but it does not prevent the device from continuing to function, and to provide ample protection.

Soldering Parameters

Non Lead-free Profile

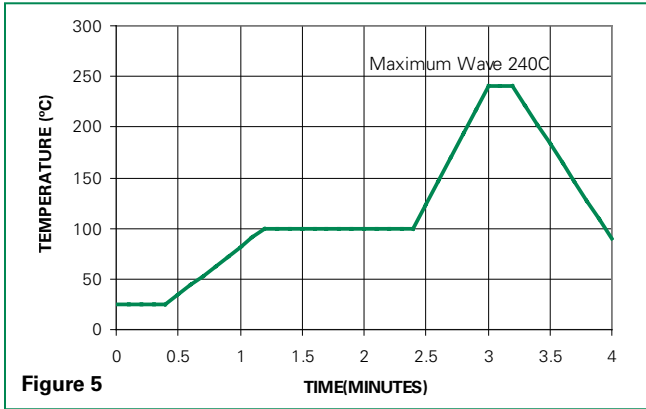

Figure 5

Lead-free Profile



Figure 6

Reflow Condition		Pb – Free assembly
Pre Heat	- Temperature Min (Ts(min))	150°C
	- Temperature Max (Ts(max))	200°C
	- Time (min to max) (ts)	60 – 180 secs
Average ramp up-rate (Liquidus Temp (TL) to peak)		5°C/second max
TS(max) to TL - Ramp-up Rate		5°C/second max
Reflow	- Temperature (TL) (Liquidus)	217°C
	- Temperature (tL)	60 – 150 seconds
Peak Temperature (TP)		250 ^{+0/-5} °C
Time within 5°C of actual peak Temperature (tp)		20 – 40 seconds
Ramp-down Rate		5°C/second max
Time 25°C to peak Temperature (TP)		8 minutes Max.
Do not exceed		260°C

Physical Specifications

Lead Material	Tin-coated Copper
Soldering Characteristics	Solderability per MIL-STD-202, Method 208
Insulating Material	Cured, flame retardant epoxy polymer meets UL94V-0 requirements.
Device Labeling	Marked with LF, voltage, amperage rating, and date code.

Environmental Specifications

Operating/Storage Temperature	-55°C to +85°C/-55°C to +125°C
Humidity Aging	+85°C, 85% RH, 1000 hours +/-10% Voltage change
Thermal Shock	+85°C to -40°C 5 times +/-10% Voltage change
Solvent Resistance	MIL-STD-202, Method 215
Moisture Sensitivity	Level 1, J-STD-020

Dimensions (mm)

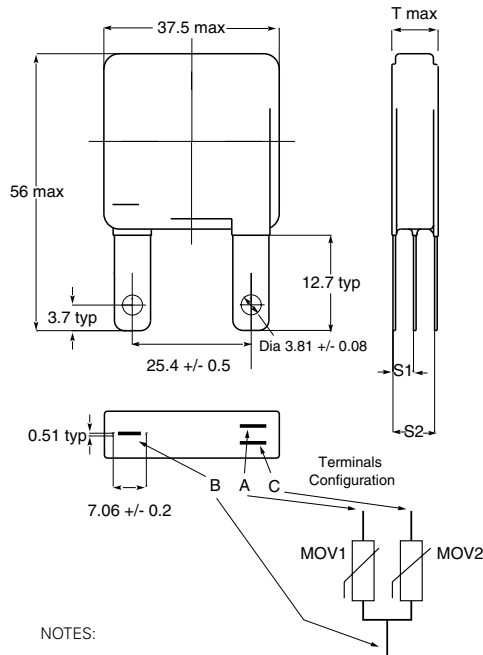

NOTES:

- **Terminals Configuration:**
Terminals A & B are connected to one varistor element.
Terminals B & C connected to second varistor element.
- **Dimensions:**
Measures are in mm is typical, unless otherwise specified.

Table of Dimensions - Thickness and Terminal Offsets

Part Type	T Max	S1 +/- 1.15 mm	S2 +/- 2.30mm
V111DHB34	7.6	2.65	5.50
V131DHB34	7.8	2.85	5.70
V141DHB34	8.2	3.00	6.00
V151DHB34	8.8	3.15	6.30
V181DHB34	9.0	3.25	6.50
V201DHB34	9.2	3.35	6.70
V251DHB34	9.10	3.00	6.00
V271DHB34	9.55	3.25	6.50
V301DHB34	10.20	3.50	7.00
V321DHB34	10.60	3.66	7.24
V331DHB34	10.65	3.70	7.40
V351DHB34	10.5	4.10	8.20
V391DHB34	11.2	4.45	8.90
V421DHB34	12.65	4.50	9.00
V441DHB34	12.80	4.55	9.10
V481DHB34	13.55	4.80	9.60
V511DHB34	13.4	5.25	10.50
V551DHB34	14.6	5.70	11.40
V571DHB34	14.8	5.80	11.60
V661DHB34	17.20	6.65	13.30
V681DHB34	17.5	7.00	14.00
V751DHB34	18.20	7.35	14.70

Part Numbering System

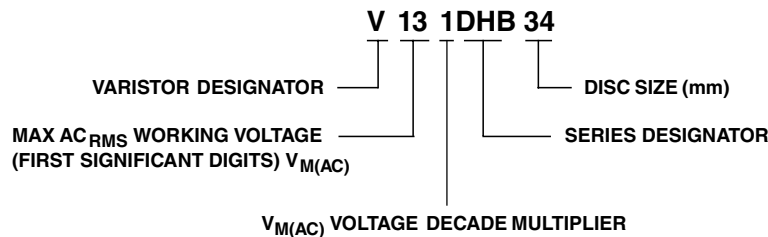

Disclaimer Notice - Information furnished is believed to be accurate and reliable. However, users should independently evaluate the suitability of and test each product selected for their own applications. Littelfuse products are not designed for, and may not be used in, all applications. Read complete Disclaimer Notice at www.littelfuse.com/disclaimer-electronics.

CA Varistor Series

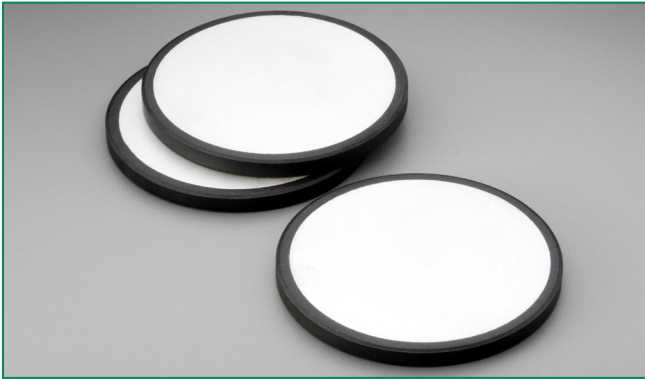

Description

The CA Series of transient surge suppressors are industrial high-energy disc varistors (MOVs) intended for special applications requiring unique electrical contact or packaging methods provided by the customer. The electrode finish of these devices is solderable and can also be used with pressure contacts. Discs of the same diameter may be stacked.

This series of industrial disc varistors are nominal 60mm diameter, with disc thickness ranging from 2.7mm to 32mm. The voltage range is 250V to 2800 V_{(AC)RMS}.

For information on soldering considerations, refer to EC637 "Recommendations for Soldering Terminal Leads to MOV Varistor Discs."

Additional Information



Datasheet



Resources



Samples

Features

- Standard disc size nominal 60mm diameter
- Discs have edge passivation insulation
- High peak pulse current range 50000A to 70000A
- Very high-energy capability W_{tm} 880J to 10000J

Absolute Maximum Ratings

• For ratings of individual members of a series, see Device Ratings and Specifications chart

Continuous	CA Series	Units
Steady State Applied Voltage:		
AC Voltage Range (V _{M(AC)RMS})	250 to 2800	V
DC Voltage Range (V _{M(DC)})	330 to 3500	V
Transient:		
Peak Pulse Current (I _{TM})		
For 8/20μs Current Wave(See Figure 2)	20,000 to 70,000	A
Single-Pulse Energy Range		
For 2ms Current Square Wave (W _{TM})	880 to 10,000	J
Operating Ambient Temperature Range (T _A)	-55 to +85	°C
Storage Temperature Range (T _{STG})	- 55 to +85	°C
Temperature Coefficient (V) of Clamping Voltage (V _C) at Specified Test Current	<0.01	%/°C

CAUTION: Stresses above those listed in "Absolute Maximum Ratings" may cause permanent damage to the device. This is a stress only rating and operation of the device at these or any other conditions above those indicated in the operational sections of this specification is not implied.

CA Series Ratings & Specifications

Part Number Device Branding	Size	Maximum Rating (85°C)				Specifications (25°C)				
		Continuous		Transient		Varistor Voltage at 1mA DC Test Current			Max Clamping Volt V_C at 200A Current (8/20 μ s)	Typical Capacitance f = 1MHz
		V_{RMS}	V_{DC}	Energy (2ms)	Peak Current (8/20 μ s)					
		$V_{M(AC)}$	$V_{M(DC)}$	W_{TM}	I_{TM}	Min	V_{NOM}	Max	V_C	
(mm)	(V)	(V)	(J)	(A)	(V)	(V)	(V)	(A)	(pF)	
V251CA60	60	250	330	880	50000	351	390	429	620	10000
V271CA60	60	275	369	950	50000	387	430	473	680	9000
V321CA60	60	320	420	1100	50000	459	510	561	760	7500
V421CA60	60	420	560	1500	70000	612	680	748	1060	6000
V481CA60	60	480	640	1600	70000	675	750	825	1160	5500
V511CA60	60	510	675	1800	70000	738	820	902	1300	5000
V571CA60	60	575	730	2100	70000	819	910	1001	1420	4500
V661CA60	60	660	850	2300	70000	945	1050	1155	1640	4000
V751CA60	60	750	970	2600	70000	1080	1200	1320	1880	3500
V881CA60	60	880	1150	3200	70000	1350	1500	1650	2340	2700
V112CA60	60	1100	1400	3800	70000	1665	1850	2035	2940	2200
V142CA60	60	1400	1750	5000	70000	2070	2300	2530	3600	1800
V172CA60	60	1700	2150	6000	70000	2500	2700	3030	4300	1500
V202CA60	60	2000	2500	7500	70000	2970	3300	3630	5200	1200
V242CA60	60	2400	3000	8800	70000	3510	3900	4290	6200	1000
V282CA60	60	2800	3500	10000	70000	4230	4700	5170	7400	800

NOTE: Average power dissipation of transients should not exceed 2.5W for CA60 discs.

Power Dissipation Ratings

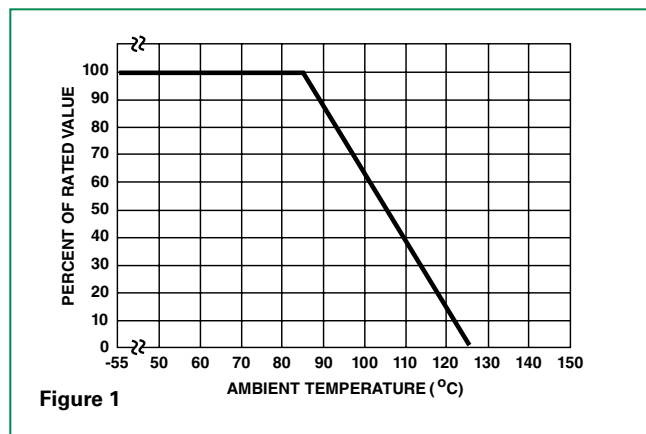

Should transients occur in rapid succession, the average power dissipation result is the energy (watt-seconds) per pulse times the number of pulses per second. The power so developed must be within the specifications shown on the Device Ratings and Specifications table for the specific device. Furthermore, the operating values need to be derated at high temperatures as shown in above. Because varistors can only dissipate a relatively small amount of average power they are, therefore, not suitable for repetitive applications that involve substantial amounts of average power dissipation.

Peak Pulse Current Test Waveform

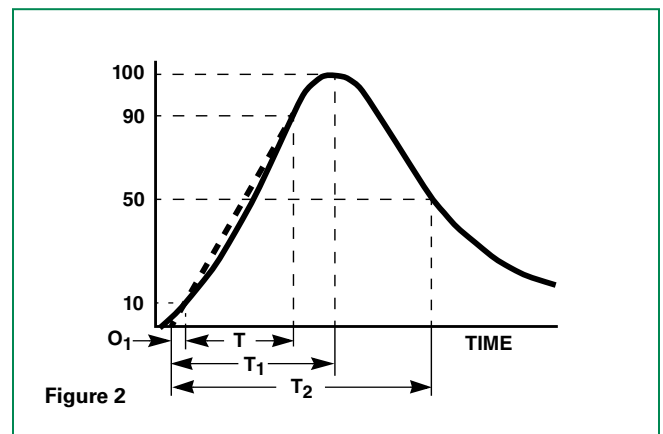

O_1 = Virtual Origin of Wave
 T = Time from 10% to 90% of Peak
 T_1 = Rise Time = $1.25 \times T$
 T_2 = Decay Time

Example - For an 8/20 μ s Current Waveform:

$8\mu s = T_1$ = Rise Time
 $20\mu s = T_2$ = Decay Time

Maximum Clamping Voltage for 60mm Parts

V251CA60 - V881CA60

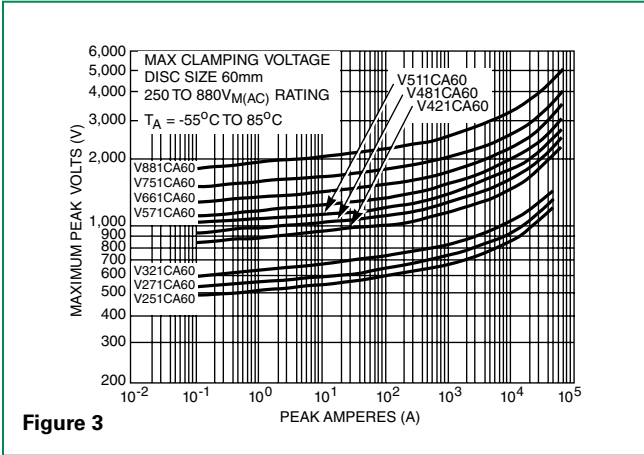

Figure 3

Repetitive Surge Capability for 60mm Parts

V251CA60 - V321CA60

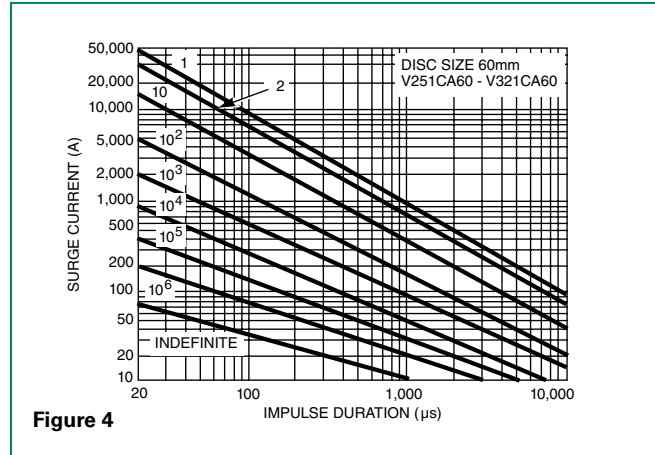

Figure 4

V112CA60 - V282CA60

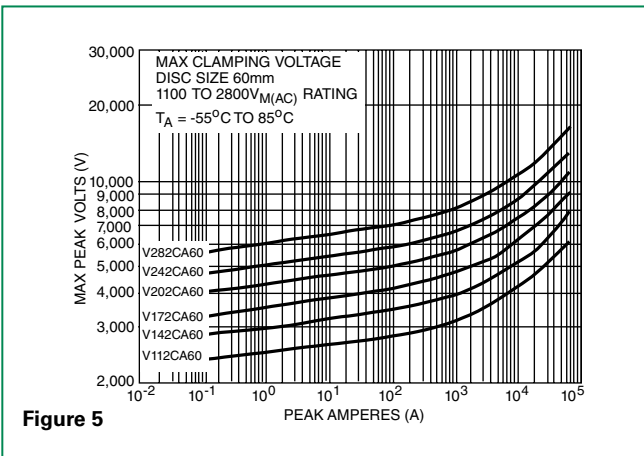

Figure 5

V421CA60 - V282CA60

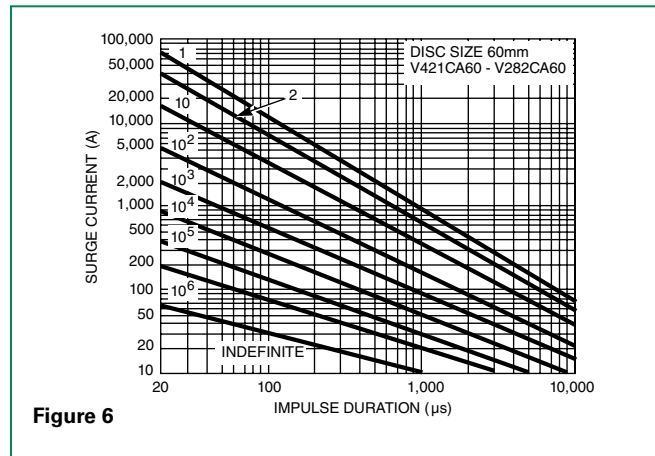

Figure 6

NOTE: If pulse ratings are exceeded, a shift of V_{NDC} (at specified current) of more than +/-10% could result. This type of shift, which normally results in a decrease of V_{NDC} , may result in the device not meeting the original published specifications, but does not prevent the device from continuing to function, and to provide ample protection.

Physical Specifications

Soldering Characteristics	Solderability per MIL-STD-202, Method 208
Insulating Material	glass passivation on edge only
Device Labeling	none

Product Dimensions (mm)

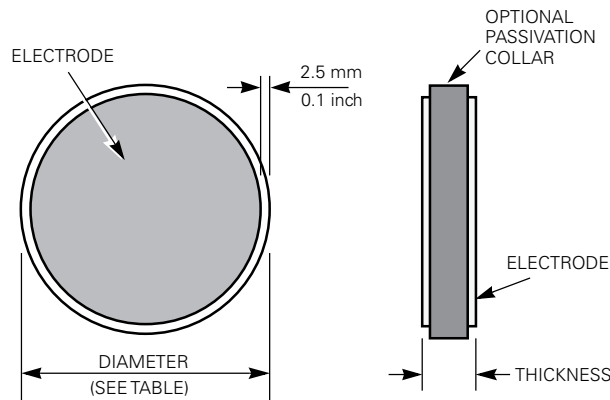

Model Size	Disc Diameter			
	Millimeters		Inches	
	Min	Max	Min	Max
60	58.0	62.0	2.283	2.441

Model V_{RMS} $V_{M(AC)}$	Disc Thickness			
	Millimeters		Inches	
	Min.	Max.	Min.	Max.
250	2.0	2.7	0.079	0.106
275	2.2	3.0	0.087	0.118
320	2.6	3.5	0.102	0.138
420	3.5	4.7	0.138	0.185
510	4.2	5.7	0.165	0.224
575	4.6	6.3	0.181	0.248
660	5.3	7.2	0.209	0.283
750	6.1	8.3	0.240	0.327
880	7.3	10.3	0.287	0.406
1100	9.2	13.0	0.362	0.512
1400	11.5	16.0	0.453	0.630
1700	14.0	19.0	0.551	0.748
2000	17.0	22.5	0.669	0.886
2400	20.0	27.0	0.787	1.063
2800	24.0	32.0	0.945	1.260

Environmental Specifications

Operating/Storage Temperature	-55°C to +85°C
Humidity Aging	+85°C, 85% RH, 1000 hours +/-10% typical voltage change
Thermal Shock	+85°C to -55°C 10 times +/-10% typical voltage change
Solvent Resistance	MIL-STD-202, Method 215
Moisture Sensitivity	Level 1, J-STD-020

Weight

Model Number	Typical Discweight (Grams)
V251CA60	39
V271CA60	42
V321CA60	50
V421CA60	66
V481CA60	71
V511CA60	80
V571CA60	88
V661CA60	101
V751CA60	116
V881CA60	141
V112CA60	178
V142CA60	220
V172CA60	265
V202CA60	317
V242CA60	377
V282CA60	450

Passivation Layer

The standard CA Series is supplied with passivation layer around the outside perimeter of the disc forming an electrical insulator as detailed in the dimensional drawing. For other options contact factory. (See Ordering Information)

Encapsulated Recommendations

After lead attachment, the disc/lead assembly may be coated or encapsulated in a package to provide electrical insulation and isolation from environmental contamination as required by the application. Coating/Filler materials for containers may include silicones, polyurethanes, and some epoxy resins. Materials containing halogens, sulfides, or alkalines are not recommended.

Stacking and Contact Pressure Recommendations

When applications require the stacking of CA60 discs, or when an electrical connection is made by pressure contacts, the pressure applied to the CA60 disc electrode surface should be minimum 2.2kgs (5 pounds) and maximum 4N/CM² (5.7LBs/IN²).

Part Numbering System

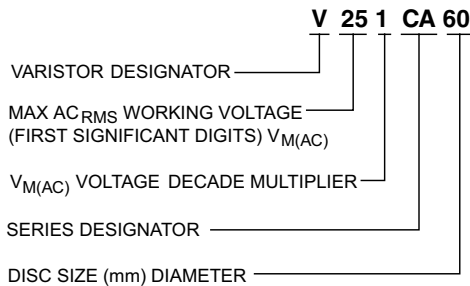

Electrode Metallization

CA60 discs are supplied as standard with sintered Silver electrodes. For other available options please contact Littelfuse.

Recommended Reflow Temperature Profile

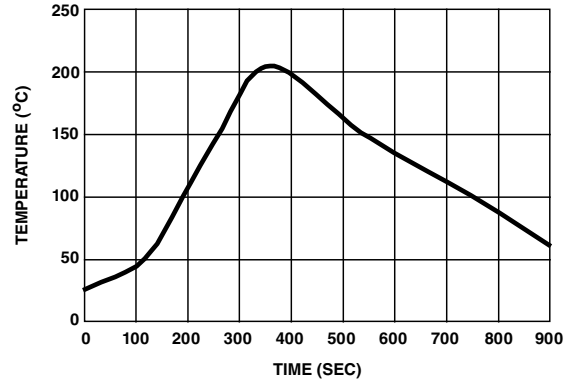

Packaging and Shipping

The CA Series is supplied in bulk for shipment. Discs are packaged in compartmentalized cartons to protect from scratching or edge-chipping during shipment.

No branding or any other type of marking appears on the CA disc itself.

CA60 discs are supplied as standard with sintered Silver electrodes and glass passivation. For other available options please contact factory.

MA Varistor Series



Agency Approvals

Agency	Agency File Number
	None

Additional Information



Datasheet



Resources



Samples

Description

The MA Series of transient surge suppressors are axial lead Metal Oxide Varistors (MOVs) for use in a wide variety of board level industrial and commercial electronic equipment. They are intended to protect components and signal/data lines from low energy transients where the small axial lead package is required.

The MA Series is offered with standard ('S' suffix) or tightened ('B' suffix) clamping voltage.

See MA Series Device Ratings and Specifications Table for part number and brand information.

Features

- Lead-free, Halogen-Free and RoHS compliant.
- 3mm diameter disc size
- Small axial lead package
- Wide operating voltage range:
 $V_{M(AC)RMS}$ 9V to 264V
 $V_{M(DC)}$ 13V to 365V
- Available in tape and reel or bulk packaging
- No derating up to 85°C ambient
- New black epoxy offers improved performance for high temperature Lead-free wave soldering process.

Absolute Maximum Ratings

• For ratings of individual members of a series, see Device Ratings and Specifications chart

Continuous	MA Series	Units
Steady State Applied Voltage:		
AC Voltage Range ($V_{M(AC)RMS}$)	9 to 264	V
DC Voltage Range ($V_{M(DC)}$)	13 to 365	V
Transient:		
Peak Pulse Current (I_{TM})		
For 8/20 μ s Current Wave(See Figure 2)	40 to 100	A
Single-Pulse Energy Range		
For 2ms Current Square Wave (W_{TM})	0.06 to 1.7	J
Operating Ambient Temperature Range (T_A)	-55 to +85	°C
Storage Temperature Range (T_{STG})	-55 to +125	°C
Temperature Coefficient (αV) of Clamping Voltage (V_C) at Specified Test Current	<0.01	%/°C
Hi-Pot Encapsulation (COATING Isolation Voltage Capability) Dielectric must withstand indicated DC voltage for one minute per MIL-STD 202, Method 301)	1000	V
COATING Insulation Resistance	1000	M Ω

CAUTION: Stresses above those listed in "Absolute Maximum Ratings" may cause permanent damage to the device. This is a stress only rating and operation of the device at these or any other conditions above those indicated in the operational sections of this specification is not implied.

MA Series Ratings & Specifications

Part Number	Brand (mm)	Maximum Rating (85°C)				Specifications (25°C)				
		Continuous		Transient		Varistor Voltage at 1mA DC Test Current			Max Clamping Volt V_C at 2.0A (8/20 μ s)	Typical Capacitance
		V_{RMS}	V_{DC}	Energy (10/1000 μ s)	Peak Current (8/20 μ s)					
		$V_{M(AC)}$	$V_{M(DC)}$	W_{TM}	I_{TM}	Min	$V_{N(DC)}$	Max	V_C	$f = 1\text{MHz}$
		(V)	(V)	(J)	(A)	(V)	(V)	(V)	(A)	(pF)
V18MA1A	18A	9	13	0.06	40	14	18	23	49	550
V18MA1B	18B	10	14	0.07	40	15	18	21	44	550
V18MA1S	18S	10	14	0.06	40	15	18	21	49	550
V22MA1A	22A	10	15	0.09	40	16	22	28	55	410
V22MA1B	22B	14	18	0.10	40	19	22	26	51	410
V22MA1S	22S	14	18	0.09	40	19	22	26	55	410
V27MA1A	27A	13	19	0.10	40	21	27	34	67	370
V27MA1B	27B	17	22	0.11	40	24	27	31	59	370
V27MA1S	27S	17	22	0.10	40	24	27	31	67	370
V33MA1A	33A	18	23	0.13	40	26	33	40	73	300
V33MA1B	33B	20	26	0.15	40	29.5	33	36.5	67	300
V33MA1S	33S	20	26	0.14	40	29.5	33	36.5	73	300
V39MA2A	39A	22	28	0.16	40	31	39	47	86	250
V39MA2B	39B	25	31	0.18	40	35	39	43	79	250
V39MA2S	39S	25	31	0.17	40	35	39	43	86	250
V47MA2A	47A	27	34	0.19	40	37	47	57	99	210
V47MA2B	47B	30	38	0.21	40	42	47	52	90	210
V47MA2S	47S	30	38	0.19	40	42	47	52	99	210
V56MA2A	56A	32	40	0.23	40	44	56	68	117	180
V56MA2B	56B	35	45	0.25	40	50	56	62	108	180
V56MA2S	56S	35	45	0.23	40	50	56	62	117	180
V68MA3A	68A	38	48	0.26	40	54	68	82	138	150
V68MA3B	68B	40	56	0.30	40	61	68	75	127	150
V68MA3S	68S	40	56	0.27	40	61	68	75	138	150
V82MA3A	82A	45	60	0.33	40	65	82	99	163	120
V82MA3B	82B	50	66	0.37	40	73	82	91	150	120
V82MA3S	82S	50	66	0.34	40	73	82	91	163	120
V100MA4A	100	57	72	0.40	40	80	100	120	200	100
V100MA4B	101	60	81	0.45	40	90	100	110	185	100
V100MA4S	102	60	81	0.42	40	90	100	110	200	100
V120MA1A	120	72	97	0.40	100	102	120	138	220	40
V120MA2B	121	75	101	0.50	100	108	120	132	205	40
V120MA2S	122	75	101	0.46	100	108	120	132	220	40
V150MA1A	150	88	121	0.50	100	127	150	173	255	32
V150MA2B	151	92	127	0.60	100	135	150	165	240	32
V180MA1A	180	105	144	0.60	100	153	180	207	310	27
V180MA3B	181	110	152	0.70	100	162	180	198	290	27
V220MA2A	220	132	181	0.80	100	187	220	253	380	21
V220MA4B	221	138	191	0.90	100	198	220	242	360	21
V270MA2A	270	163	224	0.90	100	229	270	311	460	17
V270MA4B	271	171	235	1.00	100	243	270	297	440	17
V330MA2A	330	188	257	1.00	100	280	330	380	570	14
V330MA5B	331	200	274	1.10	100	297	330	363	540	14
V390MA3A	390	234	322	1.20	100	331	390	449	670	12
V390MA6B	391	242	334	1.30	100	351	390	429	640	12
V430MA3A	430	253	349	1.50	100	365	430	495	740	11
V430MA7B	431	264	365	1.70	100	387	430	473	700	11

NOTE: Average power dissipation of transients not to exceed 200mW.

Power Dissipation Ratings

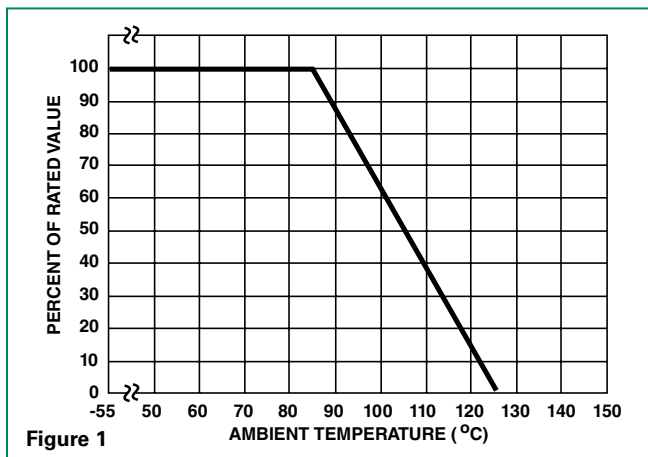

Figure 1

Should transients occur in rapid succession, the average power dissipation required is simply the energy (watt-seconds) per pulse times the number of pulses per second. The power so developed must be within the specifications shown on the Device Ratings and Specifications table for the specific device. Furthermore, the operating values need to be derated at high temperatures as shown above. Because varistors can only dissipate a relatively small amount of average power they are, therefore, not suitable for repetitive applications that involve substantial amounts of average power dissipation.

Peak Pulse Current Test Waveform

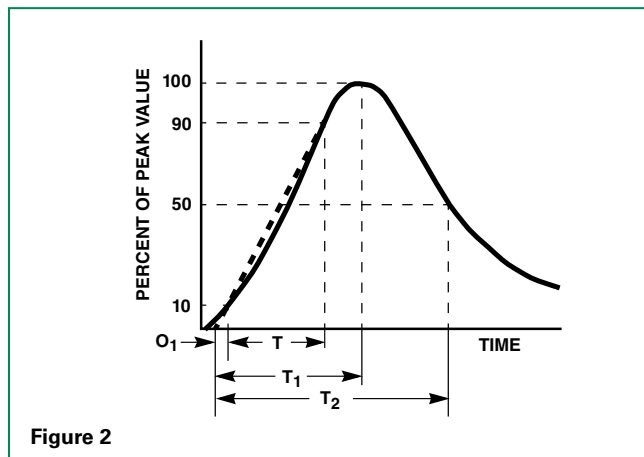

Figure 2

- O_1 = Virtual Origin of Wave
- T = Time from 10% to 90% of Peak
- T_1 = Rise Time = $1.25 \times T$
- T_2 = Decay Time

Example - For an 8/20 μ s Current Waveform:

- $8\mu s = T_1 = \text{Rise Time}$
- $20\mu s = T_2 = \text{Decay Time}$

Repetitive Surge Capability

V18MA - V100MA

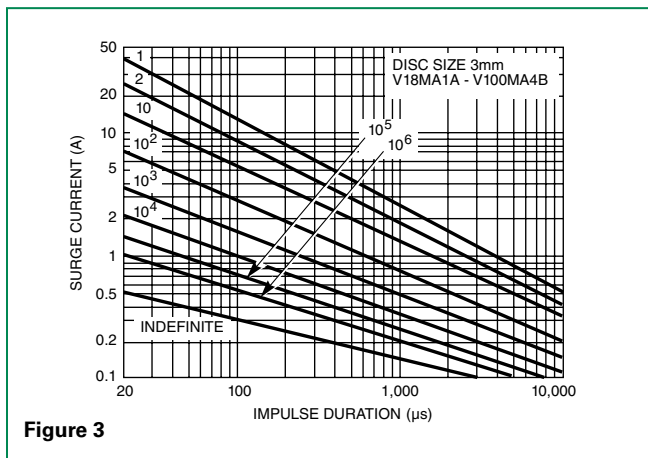

Figure 3

V120MA1A/S - V430MA3A

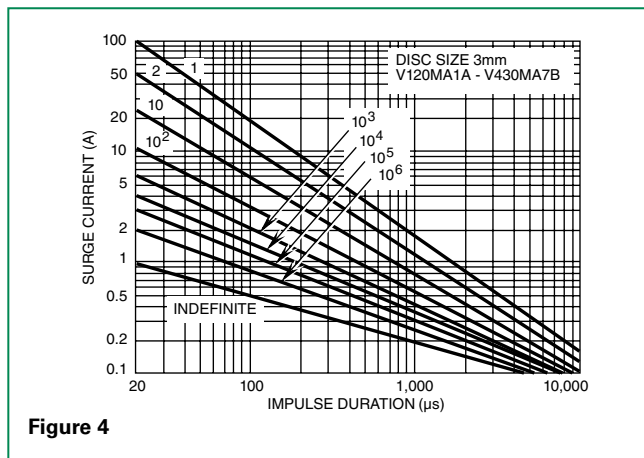

Figure 4

NOTE: If pulse ratings are exceeded, a shift of V_{NDC} (at specified current) of more than +/-10% could result. This type of shift, which normally results in a decrease of V_{NDC} , may result in the device not meeting the original published specifications, but it does not prevent the device from continuing to function, and to provide ample protection.

Maximum Clamping Voltage

V18MA1A/S - V100MA4A/S

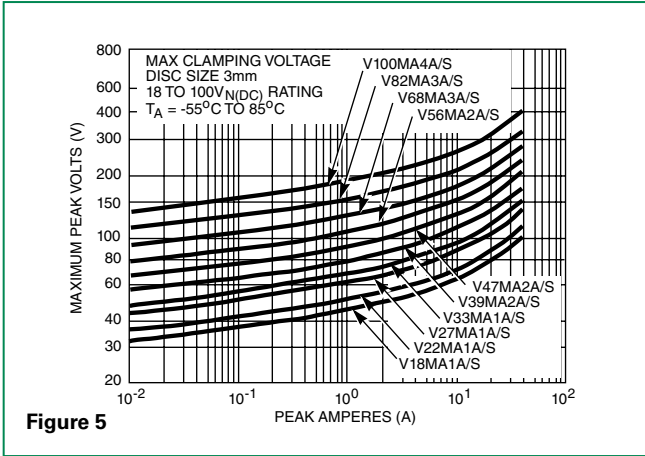

Figure 5

V18MA1B - V100MA4B

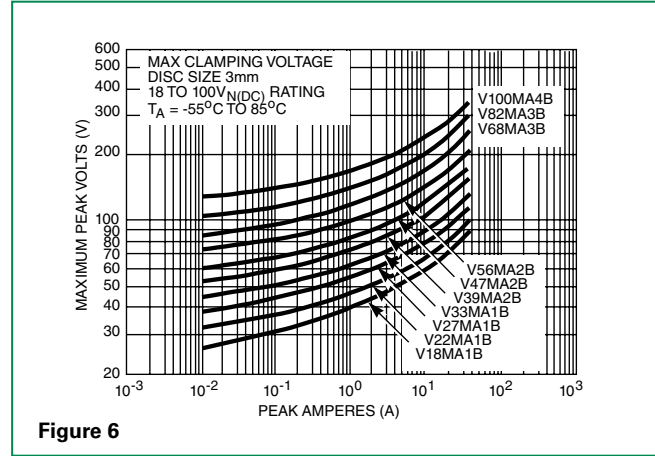

Figure 6

V120MA1A/S - V430MA3A

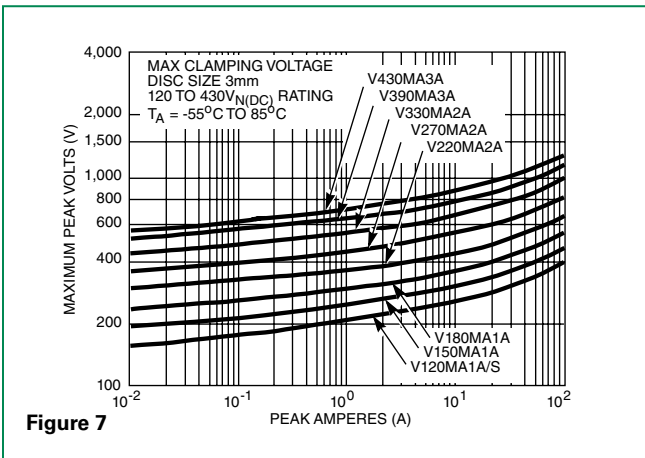

Figure 7

V120MA2B - V430MA7B

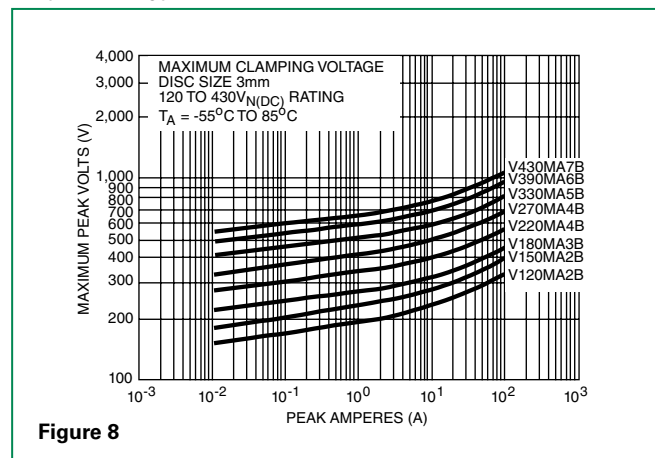

Figure 8

Wave Solder Profile

Non Lead-free Profile

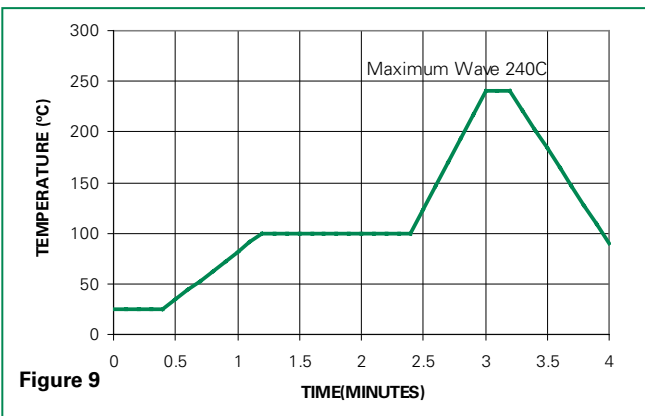

Figure 9

Lead-free Profile

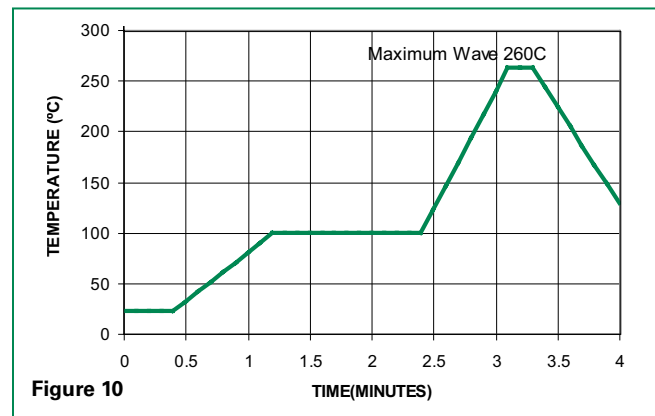
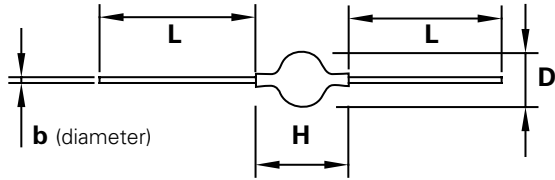

Figure 10

Product Dimensions



Symbol	Inches		Millimeters	
	Min	Max	Min	Max
Øb	0.024	0.026	0.61	0.66
ØD	0.118	0.177	3.0	4.5
H	0.177	0.276	4.5	7.0
L	1.740	1.220	27.3	31.0

Typical Weight = 0.5g

Tape and Reel Dimensions

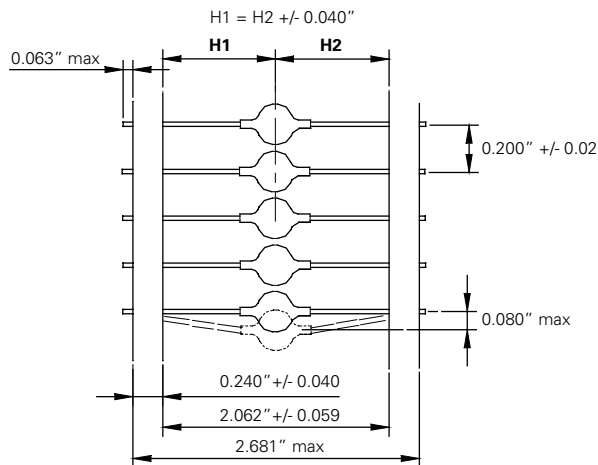

Conforms to EIA Standard RS-296-E

Physical Specifications

Lead Material	Tin-plated Copper clad steel
Soldering Characteristics	Solderability per MIL-STD-202, Method 208
Insulating Material	Cured, flame retardant epoxy polymer meets UL94V-0 requirements
Device Labeling	Marked with LF, voltage and date code

Environmental Specifications

Operating/Storage Temperature	-40°C to +85°C
Passive Aging	+85°C, 1000 hours +/-10% typical voltage change
Humidity Aging	+85°C, 85% RH, 1000 hours +/-10% typical voltage change
Thermal Shock	+85°C to -40°C 5 times +/-10% typical voltage change
Solvent Resistance	MIL-STD-202, Method 215
Moisture Sensitivity	Level 1, J-STD-020

Part Numbering System

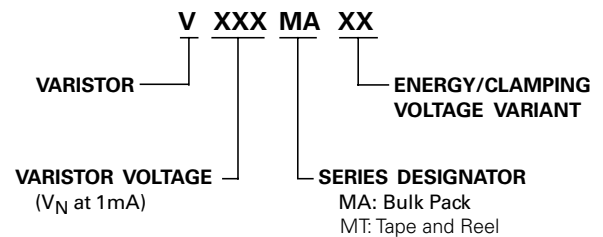

Disclaimer Notice - Information furnished is believed to be accurate and reliable. However, users should independently evaluate the suitability of and test each product selected for their own applications. Littelfuse products are not designed for, and may not be used in, all applications. Read complete Disclaimer Notice at www.littelfuse.com/disclaimer-electronics.

RA Varistor Series

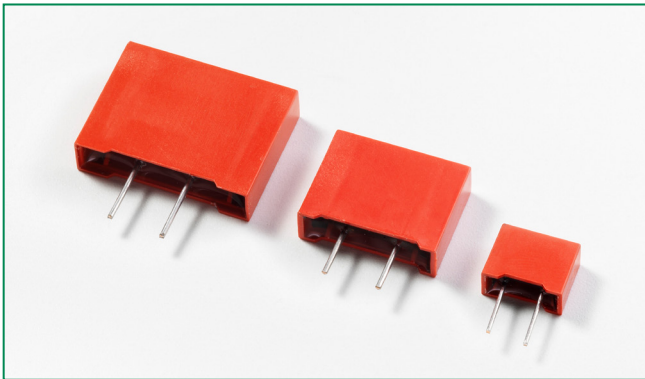

Agency Approvals

Agency	Agency Approval	Agency File Number
	UL1449	E320116

Additional Information



Datashheet



Resources



Samples

Description

The RA Series transient surge suppressors are varistors (MOVs) supplied in a low-profile box that features a precise seating plane to increase mechanical stability for secure circuit-board mounting. This feature makes these devices suitable for industrial applications critical to vibration. Their construction permits operation up to 125°C (ambient) without derating.

The RA Series are available in voltage ratings up to 275V $V_{M(AC)RMS}$ and energy levels up to 140J. These varistors are used in automotive, motor-control, telecommunication, and military applications.

See RA Series Device Ratings and Specifications Table for part number and brand information.

Features

- Lead-free/RoHS compliant parts available (add suffix "x2749")
- Low profile outline with precise seating plane
- No derating up to 125°C ambient
- In-line leads
- Wide operating voltage range:
 $V_{M(AC)RMS}$: 4 – 275V
 $V_{M(DC)}$: 5.5 – 369V
- High energy absorption capability W_{TM} up to 140J
- 3 model sizes available
A8, RA16, and RA22

Absolute Maximum Ratings

• For ratings of individual members of a series, see Device Ratings and Specifications chart

Continuous	RA8 Series	RA16 Series	RA22 Series	Units
Steady State Applied Voltage:				
AC Voltage Range ($V_{M(AC)RMS}$)	4 to 275	10 to 275	4 to 275	V
DC Voltage Range ($V_{M(DC)}$)	5.5 to 369	14 to 369	18 to 369	V
Transients:				
Peak Pulse Current (I_{TM})				
For 8/20 μ s Current Wave (See Figure 2)	100 to 1200	1000 to 4500	2000 to 6500	A
Single Pulse Energy Range (Note 1)				
For 10/1000 μ s Current Wave (W_{TM})	0.4 to 23	3.5 to 75	70 to 160	J
Operating Ambient Temperature Range (T_A)	-55 to +125	-55 to +125	-55 to +125	°C
Storage Temperature Range (T_{STG})	-55 to +150	-55 to +150	-55 to +150	°C
Temperature Coefficient (α) of Clamping Voltage (V_C) at Specified Test Current	<0.01	<0.01	<0.01	%/°C
Hi-Pot Encapsulation (COATING Isolation Voltage Capability) (Dielectric must withstand indicated DC voltage for one minute per MIL-STD 202, Method 301)	5000	5000	5000	V
COATING Insulation Resistance	1000	1000	1000	M Ω

CAUTION: Stresses above those listed in "Absolute Maximum Ratings" may cause permanent damage to the device. This is a stress only rating and operation of the device at these or any other conditions above those indicated in the operational sections of this specification is not implied.

RA Series Ratings & Specifications

Part Number	Brand	Maximum Rating (125°C)				Specifications (25°C)					
		Continuous		Transient		Varistor Voltage at 1mA DC Test Current			Max Clamping Volt V_C (8/20 μ s)		Typical Capacitance
		V_{RMS}	V_{DC}	Energy (10/1000 μ s)	Peak Current (8/20 μ s)						
		$V_{M(AC)}$	$V_{M(DC)}$	W_{TM}	I_{TM}	Min	$V_{N(DC)}$	Max	V_C	I_P	f = 1MHz
(mm)	(V)	(V)	(J)	(A)	(V)	(V)	(V)	(V)	(A)	(pF)	
† RA8 Series											
V8RA8	8R	4	5.5	0.4	150	6	8.6	11.2	22	5	3000
V12RA8	12R	6	8	0.6	150	9	12.5	16	34	5	2500
V18RA8	18R	10	14	0.8	250	16.2	18	19.8	42	5	2000
V22RA8	22R	14	18 (Note 3)	10 (Note 2)	250	19.8	22	24.2	47	5	1600
V27RA8	27R	17	22	1.0	250	24.3	27	29.7	57	5	1300
V33RA8	33R	20	26	1.2	250	29.7	33	36.3	68	5	1100
V39RA8	39R	25	31	1.5	250	35.1	39	42.9	79	5	900
V47RA8	47R	30	38	1.8	250	42.3	47	51.7	92	5	800
V56RA8	56R	35	45	2.3	250	50.4	56	61.6	107	5	700
V68RA8	68R	40	56	3.0	250	61.2	68	74.8	127	5	600
V82RA8	82R	50	66	4.0	1200	73.8	82	90.2	135	10	500
V100RA8	100R	60	81	5.0	1200	90	100	110	165	10	400
V120RA8	120R	75	102	6.0	1200	108	120	132	205	10	300
V150RA8	150R	95	127	8.0	1200	135	150	165	250	10	250
V180RA8	180R	115	153	10.0	1200	162	180	198	295	10	200
V200RA8	200R	130	175	11.0	1200	184.5	205	225.5	340	10	180
† V220RA8	220R	140	180	12.0	1200	198	220	242	360	10	160
† V240RA8	240R	150	200	13.0	1200	216	240	264	395	10	150
† V270RA8	270R	175	225	15.0	1200	243	270	297	455	10	130
† V360RA8	360R	230	300	20.0	1200	324	360	396	595	10	100
† V390RA8	390R	250	330	21.0	1200	351	390	429	650	10	90
† V430RA8	430R	275	369	23.0	1200	387	430	473	710	10	80
† RA16 Series											
V18RA16	18R16	10	14	3.5	1000	16.2	18	19.8	39	10	11000
V22RA16	22R16	14	18 (Note 3)	50 (Note 2)	1000	19.8	22	24.2	43	10	9000
V27RA16	27R16	17	22	5.0	1000	24.3	27	29.7	53	10	7000
V33RA16	33R16	20	26	6.0	1000	29.7	33	36.3	64	10	6000
V39RA16	39R16	25	31	7.2	1000	35.1	39	42.9	76	10	5000
V47RA16	47R16	30	38	8.8	1000	42.3	47	51.7	89	10	4500
V56RA16	56R16	35	45	10.0	1000	50.4	56	61.6	103	10	3900
V68RA16	68R16	40	56	13.0	1000	61.2	68	74.8	123	10	3300
V82RA16	82R16	50	66	15.0	4500	73.8	82	90.2	145	50	2500
V100RA16	100R16	60	81	20.0	4500	90	100	110	175	50	2000
V120RA16	120R16	75	102	22.0	4500	108	120	132	205	50	1700
V150RA16	150R16	95	127	30.0	4500	135	150	165	255	50	1400
V180RA16	180R16	115	153	35.0	4500	162	180	198	300	50	1100
V200RA16	200R16	130	175	38.0	4500	184.5	205	225.5	340	50	1000
† V220RA16	220R16	140	180	42.0	4500	198	220	242	360	50	900
† V240RA16	240R16	150	200	45.0	4500	216	240	264	395	50	800
† V270RA16	270R16	175	225	55.0	4500	243	270	297	455	50	700
† V360RA16	360R16	230	300	70.0	4500	324	360	396	595	50	550
† V390RA16	390R16	250	330	72.0	4500	351	390	429	650	50	500
† V430RA16	430R16	275	369	75.0	4500	387	430	473	710	50	450

RA Series Ratings & Specifications

Part Number	Brand	Maximum Rating (125°C)				Specifications (25°C)					
		Continuous		Transient		Varistor Voltage at 1mA DC Test Current			Max Clamping Volt V_C (8/20 μ s)		Typical Capacitance
		V_{RMS}	V_{DC}	Energy (10/1000 μ s)	Peak Current (8/20 μ s)						
		$V_{M(AC)}$	$V_{M(DC)}$	W_{TM}	I_{TM}	Min	$V_{N(DC)}$	Max	V_C	I_P	f = 1MHz
(mm)	(V)	(V)	(J)	(A)	(V)	(V)	(V)	(V)	(A)	(pF)	
† RA22 Series											
V24RA22	24R22	14	18 (Note 3)	100.0 (Note 2)	2000	21.6	24	26.4	43	20	18000
V36RA22	36R22	23	31	160.0 (Note 2)	2000	32.4	36	39.6	63	20	12000
† V200RA22	200R22	130	175	70.0	6500	184.5	205	225.5	340	100	1900
† V240RA22	240R22	150	200	80.0	6500	216	240	264	395	100	1600
† V270RA22	270R22	175	225	90.0	6500	243	270	297	455	100	1400
† V390RA22	390R22	250	330	130.0	6500	351	390	429	650	100	1000
† V430RA22	430R22	275	369	140.0	6500	387	430	473	710	100	900

- NOTES:
1. Average power dissipation of transients not to exceed 0.25W for RA8 Series, 0.60W for RA16 Series, or 1.0W for RA22 Series.
 2. Energy ratings for impulse duration of 30ms minimum to one half of peak current value.
 3. Also rated to withstand 24V for 5 minutes.
 4. 10mA DC Test Current.
- † Under UL File No. E320116 as a recognized component. CSA approved File No. 91788.

Power Dissipation Ratings

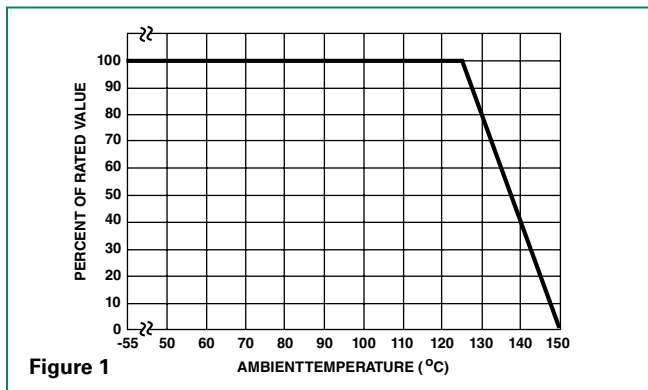

Should transients occur in rapid succession, the average power dissipation required is simply the energy (watt-seconds) per pulse times the number of pulses per second. The power so developed must be within the specifications shown on the Device Ratings and Specifications table for the specific device. Furthermore, the operating values need to be derated at high temperatures as shown above. Because varistors can only dissipate a relatively small amount of average power they are, therefore, not suitable for repetitive applications that involve substantial amounts of average power dissipation.

Peak Pulse Current Test Waveform

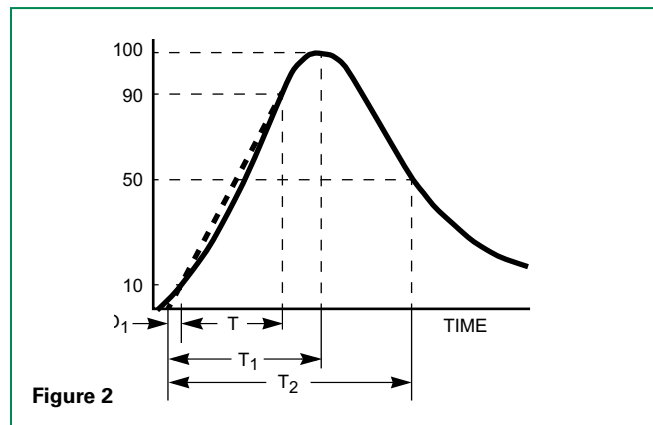

- O_1 = Virtual Origin of Wave
- T = Time from 10% to 90% of Peak
- T_1 = Rise Time = $1.25 \times T$
- T_2 = Decay Time

Example - For an 8/20 μ s Current Waveform:
 $8\mu s = T_1 = \text{Rise Time}$
 $20\mu s = T_2 = \text{Decay Time}$

Maximum Clamping Voltage for 8mm Parts

V8RA8 - V68RA8

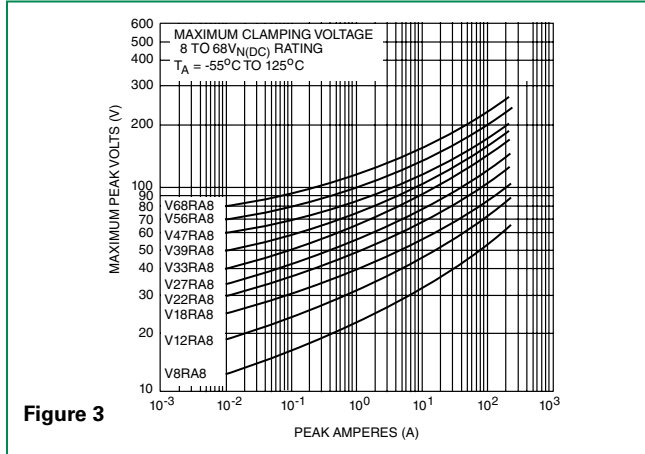

Figure 3

Repetitive Surge Capability for 8mm Parts

V8RA8 - V12RA8

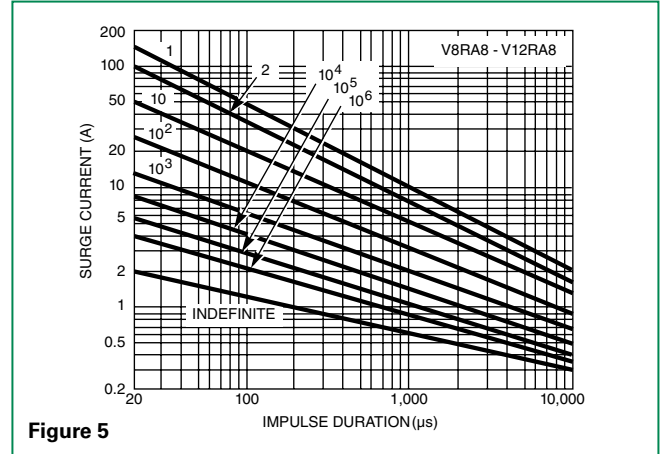

Figure 5

V82RA8 - V430RA8

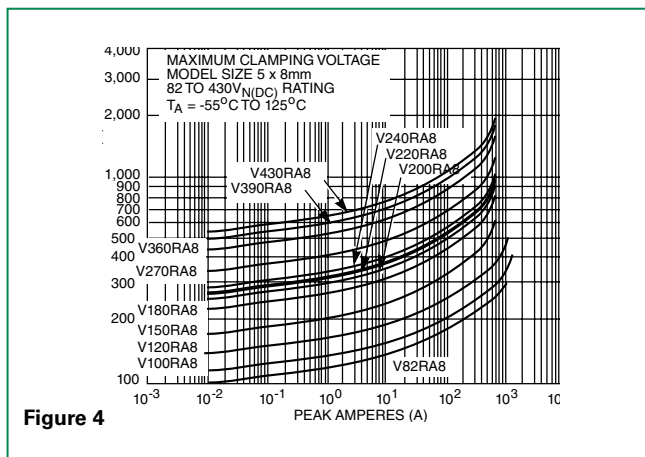

Figure 4

V18RA8 - V68RA8

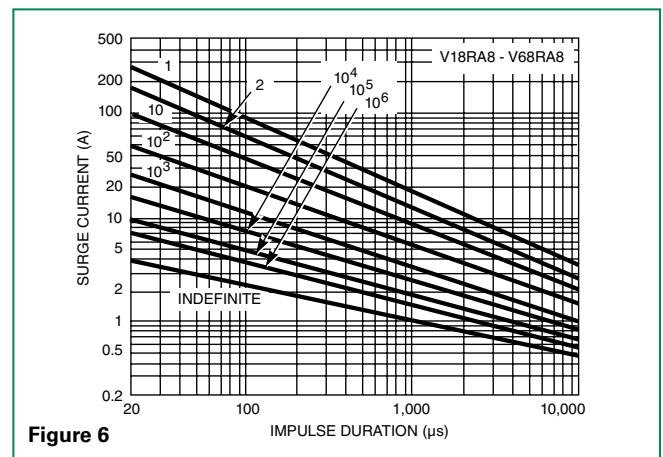

Figure 6

V82RA8 - V430RA8

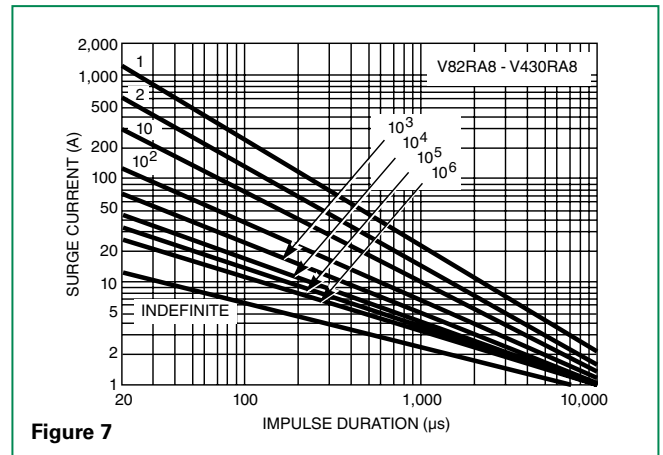

Figure 7

Maximum Clamping Voltage for 16mm Parts

V18RA16 - V68RA16

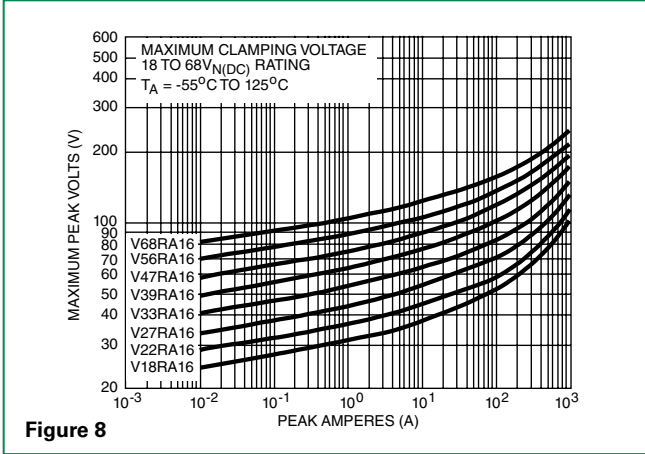

Figure 8

Repetitive Surge Capability for 16mm Parts

V18RA16 - V68RA16

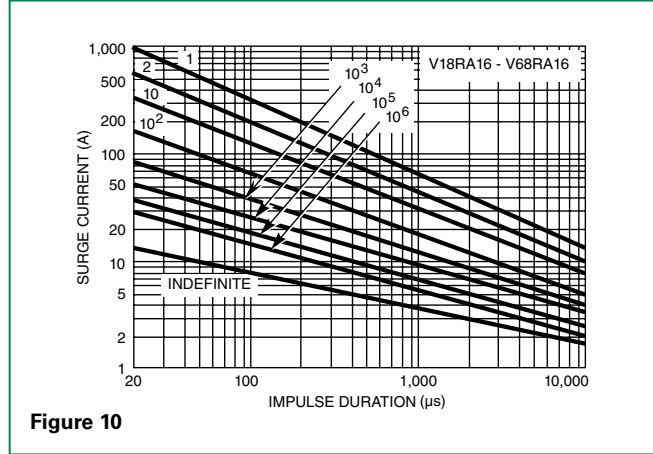

Figure 10

V82RA16 - V430RA16

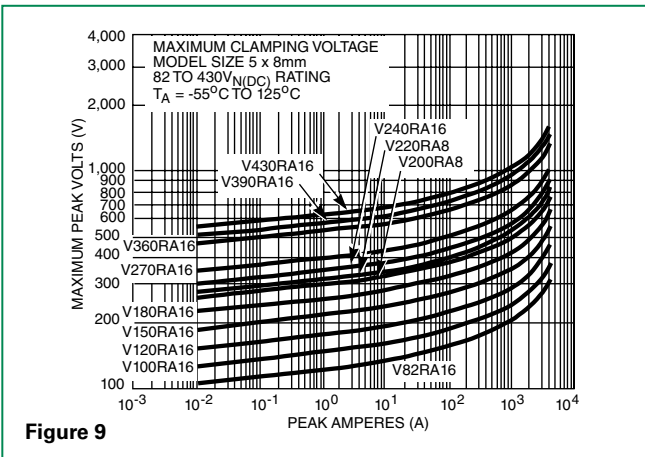

Figure 9

V82RA16 - V430RA16

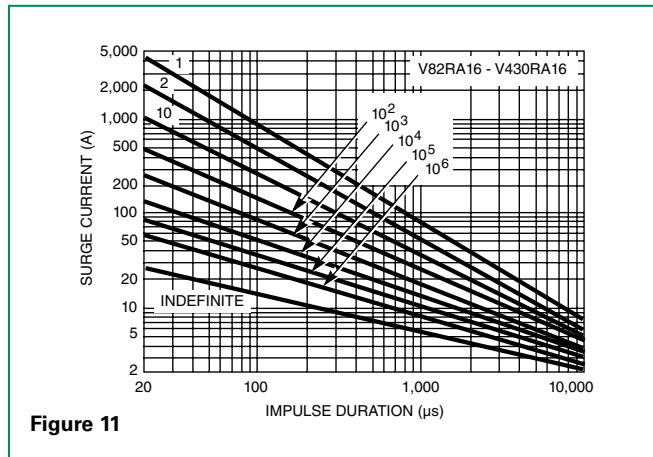

Figure 11

Maximum Clamping Voltage for 22mm Parts

V24RA22 - V36RA22

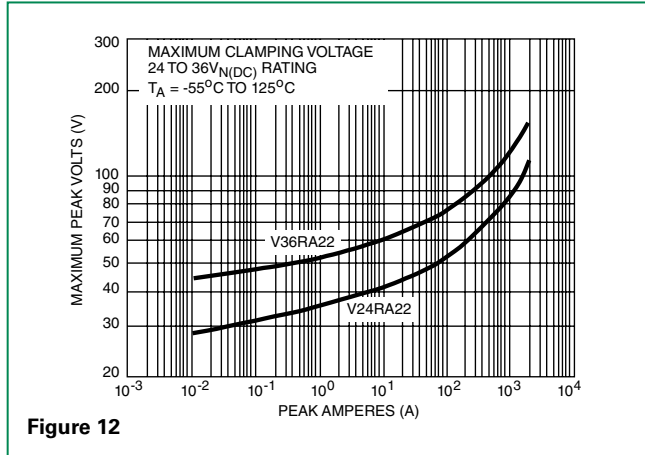

Figure 12

Repetitive Surge Capability for 22mm Parts

V24RA22 - V36RA22

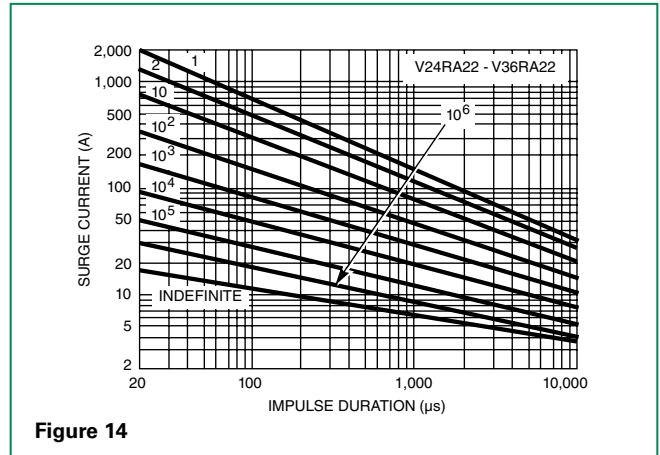

Figure 14

V200RA22 - V430RA22

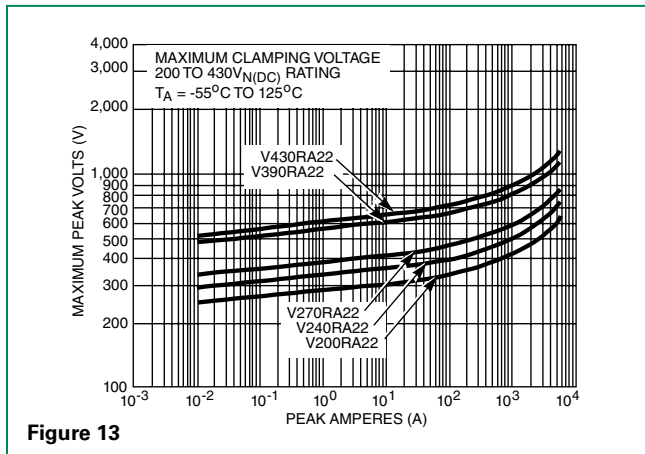

Figure 13

V200RA22 - V430RA22

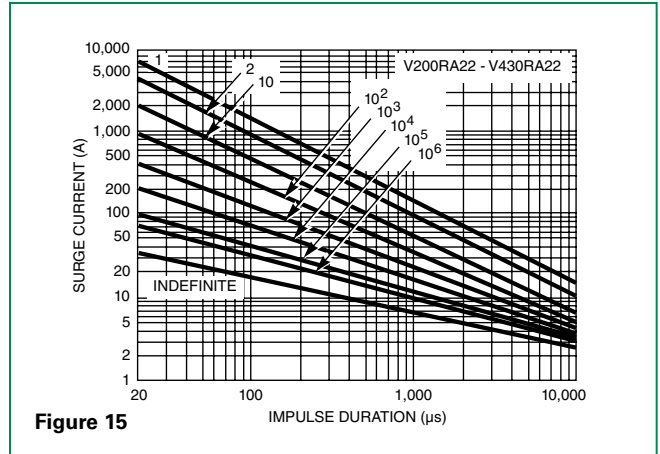

Figure 15

NOTE: If pulse ratings are exceeded, a shift of $V_{N(DC)}$ (at specified current) of more than $\pm 10\%$ could result. This type of shift, which normally results in a decrease of $V_{N(DC)}$, may result in the device not meeting the original published specifications, but it does not prevent the device from continuing to function, and to provide ample protection.

Wave Solder Profile

Reflow Condition		Pb – Free assembly
Pre Heat	- Temperature Min (Ts(min))	150°C
	- Temperature Max (Ts(max))	200°C
	- Time (min to max) (ts)	60 – 180 secs
Average ramp-up rate (Liquidus Temp (TL) to peak)		5°C/second max
TS(max) to TL - Ramp-up Rate		5°C/second max
Reflow	- Temperature (TL) (Liquidus)	217°C
	- Temperature (tL)	60 – 150 seconds
Peak Temperature (TP)		250+0/-5°C
Time within 5°C of actual peak Temperature (tp)		20 – 40 seconds
Ramp-down Rate		5°C/second max
Time 25°C to peak Temperature (TP)		8 minutes Max.
Do not exceed		260°C

Lead-free Profile

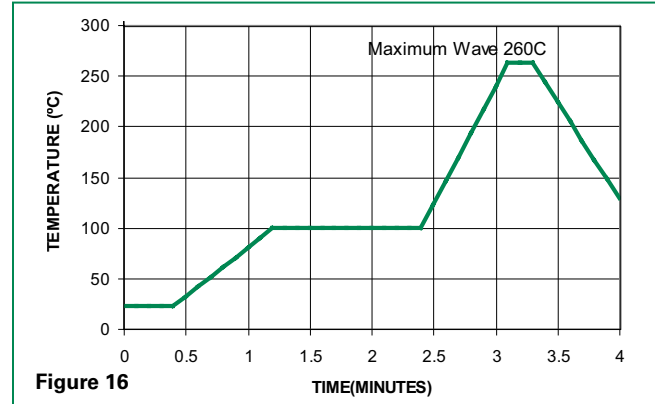

Non Lead-free Profile

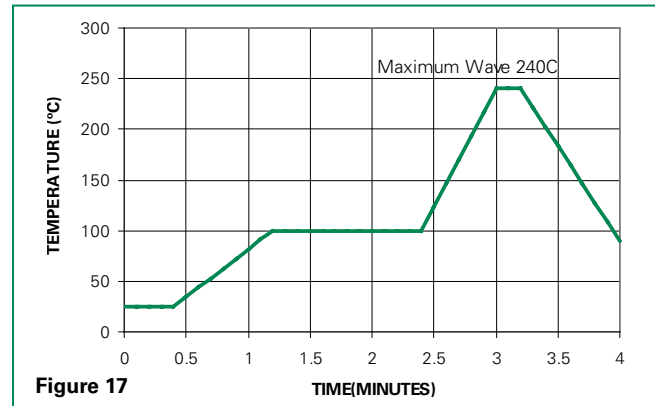

Environmental Specifications

Operating/Storage Temperature	-55°C to +125°C / -55°C to +150°C
Humidity Aging	+85°C, 85% RH, 1000 hours +/-10% Voltage
Thermal Shock	+85°C to -40°C 10 times +/-10% Voltage
Solvent Resistance	MIL-STD-202, Method 215
Moisture Sensitivity	Level 1, J-STD-020

Physical Specifications

Lead Material	Tin-Coated
Soldering Characteristics	Solderability per MIL-STD-202, Method 208
Insulating Material	Cured, flame retardant epoxy polymer meets UL94V-0 requirements.
Device Labeling	Marked with LF, voltage, amperage rating, and date code.

Product Dimensions (mm)

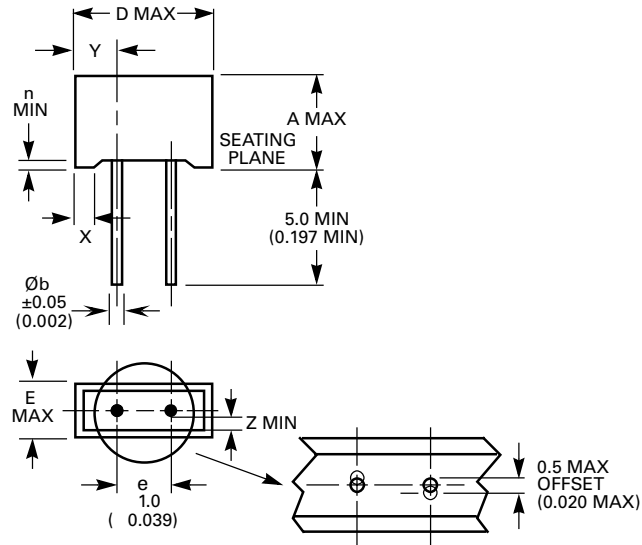

SYMBOL	RA8 Series	RA16 Series	RA22 Series
A (max.)	8.85 (0.348)	15.1 (0.594)	19.1 (0.752)
D (max.)	11.45 (0.450)	19.7 (0.776)	25.5 (1.004)
e ± 1	5 (0.197)	7.5 (0.295)	7.5 (0.295)
E (max.)	5.2 (0.205)	6.3 (0.248)	6.3 (0.248)
n (max.)	0.7 (0.027)	0.7 (0.027)	0.7 (0.027)
Øb ± 0.05	0.635 (0.025)	0.81 (0.032)	0.81 (0.032)
Weight (typical)	1 Gram	3.4 Grams	4.4 Grams
X	2.2 (0.087)	2.2 (0.087)	4.4 (0.173)
Y (Typ.)	3.1 -/+ 0.5 (0.122 -/+ 0.02)	6 -/+ 1 (0.236 -/+ 0.04)	8.9 -/+ 1 (0.35 -/+ 0.04)
Z (min.)	0.4 (0.015)	0.8 (0.031)	0.8 (0.031)

NOTES: Dimensions are in mm, with dimensions in inches in parentheses.
 Inches for reference only.

Part Numbering System

The RA Series is supplied in bulk pack.

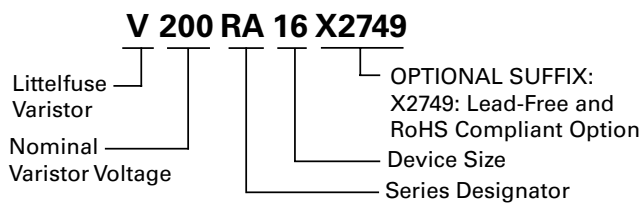

Disclaimer Notice - Information furnished is believed to be accurate and reliable. However, users should independently evaluate the suitability of and test each product selected for their own applications. Littelfuse products are not designed for, and may not be used in, all applications. Read complete Disclaimer Notice at www.littelfuse.com/disclaimer-electronics.

High Reliability Varistors



Agency Approvals

- QPL

Additional Information



Datasheet



Resources



Samples

Description

Littelfuse High Reliability Varistors offer the latest in increased product performance, and are available for applications requiring quality and reliability assurance levels consistent with military or other standards (MIL-STD-19500, MIL-STD-202). Additionally, Littelfuse Varistors are inherently radiation hardened compared to Silicon Diode suppressors as illustrated in Figure 1.

Littelfuse High-Reliability Varistors involve four categories:

- 1 Qualified Products List (QPL) MIL-R-83530**
(4 items presently available)
- 2 Littelfuse High Reliability Series TX Equivalents**
(29 items presently available)
- 3 Custom Types**
Processed to customer-specific requirements
- (SCD) or to Standard Military Flow

Disclaimer Notice - Information furnished is believed to be accurate and reliable. However, users should independently evaluate the suitability of and test each product selected for their own applications. Littelfuse products are not designed for, and may not be used in, all applications. Read complete Disclaimer Notice at www.littelfuse.com/disclaimer-electronics.

1) DSSC Qualified Parts List (QPL) MIL-R-83530

This series of varistors are screened and conditioned in accordance with MIL-R-83530. Manufacturing system conforms to MIL-I-45208; MIL-Q-9858.

Table 1. MIL-R-83530/1 Ratings and Characteristics

Part Number M83530/	Nominal Varistor Voltage (V)	Tolerance (%)	Voltage Rating (V)		Energy Rating (J)	Clamping Voltage at 100A (V)	Capacitance at 1MHz (pF)	Clamping Voltage At Peak Current Rating (V)	Nearest Commercial Equivalent
			(RMS)	(DC)					
1-2000B	200	-/+ 10	130	175	50	325	3800	570	V130LA20B
1-2200D	220	+10, -5	150	200	55	360	3200	650	V150LA20B
1-4300E	430	+5, -10	275	369	100	680	1800	1200	V275LA40B
1-5100E	510	+5, -10	320	420	120	810	1500	1450	V320LA40B

2) Littelfuse High Reliability Series TX Equivalents

Table 2. Available TX Model Types

TX Model	Model Size	Device Mark	(See Section 4) Nearest Commercial Equivalent	TX Model	Model Size	Device Mark	(See Section 4) Nearest Commercial Equivalent
V8ZTX1 V8ZTX2	7mm 10mm	8TX1 8TX2	V8ZA1 V8ZA2	V130LTX2 V130LTX10A V130LTX20B	7mm 14mm 20mm	130TX2 130L10 130TX20	V130LA2 V130LA10A V130LA20A
V12ZTX1 V12ZTX2	7mm 10mm	12TX1 12TX2	V12ZA1 V12ZA2	V150LTX2 V150LTX10A V150LTX20B	7mm 14mm 20mm	150L2 150TX10 150L20	V150LA2 V150LA10A V150LA20B
V22ZTX1 V22ZTX3	7mm 14mm	22TX1 22TX3	V22ZA1 V22ZA3	V250LTX4 V250LTX20A V250LTX40B	7mm 14mm 20mm	250L4 250L20 250L40	V250LA4 V250LA20A V250LA40B
V24ZTX50	20mm	24TX50	V24ZA50	V420LTX20A V420LTX40B	14mm 20mm	420L20 420L40	V420LA20A V420LA40B
V33ZTX1 V33ZTX5 V33ZTX70	7mm 14mm 20mm	33TX1 33TX5 33TX70	V33ZA1 V33ZA5 V33ZA70	V480LTX40A V480LTX80B	14mm 20mm	480L40 480TX80	V480LA40A V480LA80B
V68ZTX2 V68ZTX10	7mm 14mm	68TX2 68TX10	V68ZA2 V68ZA10	V510LTX40A V510LTX80B	14mm 20mm	510L40 510L80	V510LA40A V510LA80B
V82ZTX2 V82ZTX12	7mm 14mm	82TX2 82TX12	V82ZA2 V82ZA12				

The TX Series of varistors are 100% screened and conditioned in accordance with MIL-STD-750. These tests are outlined in table 3 below

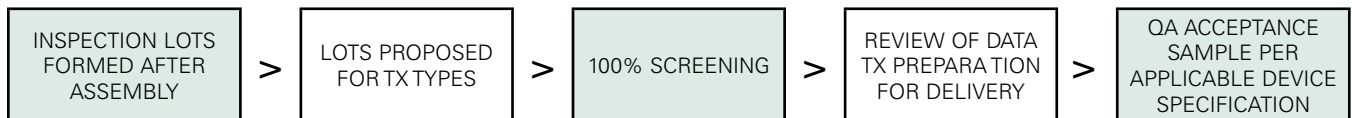

Table 3. TX Equivalents Series 100% Screening

	MIL-STD-105		LTPD
	LEVEL	AQL	
Electrical (Bidirectional) V_{NIDC} , V_C (Per Specifications Table)	II	0.1	-
Dielectric Withstand Voltage MIL-STD-202, Method 301, 2500V Min. at $1.0\mu A_{DC}$	-	-	15
Solderability MIL-STD-202, Method 208, No Aging, Non-Activated	-	-	15

Table 4. Quality Assurance Acceptance Tests

Screen	MIL-STD-750 Method	Condition	TX Requirements
High Temperature Life (Stabilization Bake)	1032	24 hours min at max rated storage temperature.	100%
Thermal Shock (Temperature Cycling)	1051	No dwell is required at 25°C. Test condition A1, 5 cycles -55°C to +125°C (extremes) >10 minutes.	100%
Humidity Life		85°C, 85% RH, 168 Hrs.	100%
Interim Electrical $V_{N(DC)}$ V_C (Note 3)		As specified, but including delta parameter as a minimum.	100% Screen
Power Burn-In	1038	Condition B, 85°C, rated $V_{M(AC)}$, 72 hours min.	100%
Final Electrical $+V_{N(DC)}$ V_C (Note 3)		As specified - All parameter measurements must be completed within 96 hours after removal from burn-in conditions.	100% Screen
External Visual Examination	2071	To be performed after complete marking.	100%

3) Custom Types

In addition to our comprehensive high-reliability series, Littelfuse can screen and condition to specific requirements. Additional mechanical and environmental capabilities are defined in Table 5.

Table 5. Mechanical And Environmental Capabilities (Typical Conditions)

Test Name	Test Method	Description
Terminal Strength	MIL-STD-750-2036	3 Bends, 90° Arc, 16oz. Weight
Drop Shock	MIL-STD-750-2016	1500g's, 0.5ms, 5 Pulses, X_1 , V_1 , Z_1
Variable Frequency Vibration	MIL-STD-750-2056	20g's, 100-2000Hz, X_1 , V_1 , Z_1
Constant Acceleration	MIL-STD-750-2006	V_2 , 20,000g's Min
Salt Atmosphere	MIL-STD-750-1041	35°C, 24Hr, 10-50g/m ² Day
Soldering Heat/Solderability	MIL-STD-750-2031/2026	260°C, 10s, 3 Cycles, Test Marking
Resistance to Solvents	MIL-STD-202-215	Permanence, 3 Solvents
Flammability	MIL-STD-202-111	15s Torching, 10s to Flameout
Cyclical Moisture Resistance	MIL-STD-202-106	10 Days
Steady-State Moisture Resistance	MIL-STD-750-1021.3	85/85 96Hr
Biased Moisture Resistance	MIL-STD-750-1021.3	Not Recommended for High-Voltage Types
Temperature Cycle	MIL-STD-202-107	-55°C to 125°C, 5 Cycles
High-Temperature Life (Nonoperating)	MIL-STD-750-1032	125°C, 24Hr
Burn-In	MIL-STD-750-1038	Rated Temperature and V_{RMS}
Hermetic Seal	MIL-STD-750-1071	Condition D

Radiation Hardness

For space applications, an extremely important property of a protection device is its response to imposed radiation effects.

Electron Irradiation

A Littelfuse MOV and a Silicon transient suppression diode were exposed to electron irradiation. The V-I curves, before and after test, are shown below.

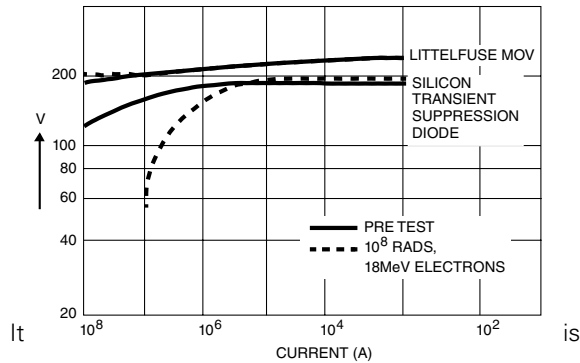

FIGURE 1. RADIATION SENSITIVITY OF LITTELFUSE V130LA1 AND SILICON TRANSIENT SUPPRESSION DIODE

apparent that the Littelfuse MOV was virtually unaffected, even at the extremely high dose of 108 rads, while the Silicon transient suppression diode showed a dramatic increase in leakage current.

Neutron Effects

A second MOV-Zener comparison was made in response to neutron fluence. The selected devices were equal in area.

Figure 2 shows the clamping voltage response of the MOV and the Zener to neutron irradiation to as high as 1015 N/cm². It is apparent that in contrast to the large change in the Zener, the MOV is unaltered. At higher currents where the MOV's clamping voltage is again unchanged, the Zener device clamping voltage increases by as much as 36%.

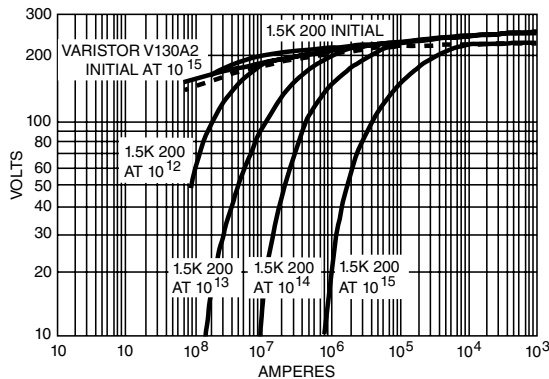

FIGURE 2. V-I CHARACTERISTIC RESPONSE TO NEUTRON IRRADIATION FOR MOV AND ZENER DIODE DEVICES

Counterclockwise rotation of the V-I characteristics is observed in Silicon devices at high neutron irradiation levels; in other words, increasing leakage at low current levels and increasing clamping voltage at higher current levels.

The solid and open circles for a given fluence represent the high and low breakdown currents for the sample of devices tested. Note that there is a marked decrease in current (or energy) handling capability with increased neutron fluence.

Failure threshold of Silicon semiconductor junctions is further reduced when high or rapidly increasing currents are applied. Junctions develop hot spots, which enlarge until a short occurs if current is not limited or quickly removed.

The characteristic voltage current relationship of a P-N Junction is shown below.

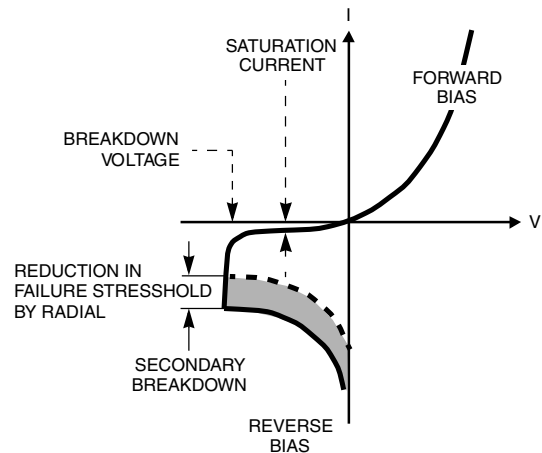

FIGURE 3. V-I CHARACTERISTIC OF PN-JUNCTION

At low reverse voltage, the device will conduct very little current (the saturation current). At higher reverse voltage VBO (breakdown voltage), the current increases rapidly as the electrons are either pulled by the electric field (Zener effect) or knocked out by other electrons (avalanching). A further increase in voltage causes the device to exhibit a negative resistance characteristic leading to secondary breakdown.

This manifests itself through the formation of hotspots, and irreversible damage occurs. This failure threshold decreases under neutron irradiation for Zeners, but not for Z_NO Varistors.

Gamma Radiation

Radiation damage studies were performed on type V130LA2 varistors. Emission spectra and V-I characteristics were collected before and after irradiation with 106 rads Co60 gamma radiation. Both show no change, within experimental error, after irradiation.

TMOV® and iTMOV® Varistor Series



Description



The Littelfuse TMOV® and iTMOV® thermally protected varistors represent a new development in integrated circuit protection. Both versions are comprised of radial leaded Metal Oxide Varistors (MOVs) with an integrated thermally activated element designed to open in the event of overheating due to the abnormal overvoltage, limited current, conditions outlined in UL1449. The TMOV® and iTMOV® varistor's integrated thermal element, in conjunction with appropriate enclosure design, helps facilitate SPD module compliance to UL1449 for both cord connected and permanently connected applications.

The TMOV® and iTMOV® varistors offer quick thermal response due to the close proximity of the integrated thermal element to the MOV body. The integrated configuration also offers lower inductance than most discrete solutions resulting in improved clamping performance to fast overvoltage transients.

The iTMOV® varistor differs from the TMOV® varistor by the inclusion of a third lead for the purpose of indicating that the MOV has been disconnected from the circuit. This lead facilitates connection to monitoring circuitry.

Additionally TMOV® and iTMOV® varistors are wave solderable, thus simplifying end product assembly by reducing the the expense and rework associated with hand soldering operations.

Agency Approvals

Agency	Agency Approval	Agency File Number
	UL 1449	E320116
	QC 42201-C001, QC 42201-A001, IEC 60950-1 (Annex Q)	IECQ-C BSI 15.0009
	IEC 61051-1, IEC 61051-2, IEC 60950-1 (Annex Q)	40021525

Additional Information



**Datasheet
iTMOV**



**Resources
iTMOV**



**Samples
iTMOV**



**Datasheet
TMOV**



**Resources
TMOV**



**Samples
TMOV**

Features

- RoHS compliant and Lead-free available
- -55°C to +85°C operating temp range
- Designed to facilitate compliance to UL1449 for SPD products
- Three-lead version available for indication purposes
- High peak surge current rating up to 10kA
- Wave solderable
- Standard lead form and spacing option

Applications

- SPD Products
- AC Panel Protection Modules
- AC Line Power Supplies
- Surge Protected Strip Connectors
- AC Power Meters
- Relocatable AC Power Taps
- GFCI (Ground Fault Current Interrupter)
- UPS (Uninterruptable Power Supply)
- White Goods
- Plug-in SPD
- Inverters
- AC/DC Power Supplies

Absolute Maximum Ratings

• For ratings of individual members of a series, see Device Ratings and Specifications chart

Continuous	TMOV [®] and iTMOV [®] Varistor Series	Units
Steady State Applied Voltage:		
AC Voltage Range ($V_{M(AC)RMS}$)	115 to 750	V
Transient:		
Peak Pulse Current (I_{TM}) - For 8x20 μ s Current Wave, single pulse	6,000 to 10,000	A
Single-Pulse Energy Capability - For 2ms Current Wave	35 to 480	J
Operating Ambient Temperature Range (T_A)	-55 to +85	°C
Storage Temperature Range (T_{STG})	-55 to +125	°C
Temperature Coefficient (α_V) of Clamping Voltage (V_C) at Specified Test Current	<0.01	%/°C
Hi-Pot Encapsulation (COATING Isolation Voltage Capability)	2,500	V
Thermal Protection Isolation Voltage Capability (when operated)	600	V
COATING Insulation Resistance	1,000	M Ω
Indicator Lead Rating (Lead-3 - iTMOV [®] varistor only):		
Continuous RMS current	100	mA
Surge Current, 8/20 μ s	10,000	A

CAUTION: Stresses above those listed in "Absolute Maximum Ratings" may cause permanent damage to the device. This is a stress only rating and operation of the device at these or any other conditions above those indicated in the operational sections of this specification is not implied.

Ratings & Specifications

TMOV [®] Varistor Lead-free And RoHS Compliant Models		iTMOV [®] Varistor Lead-free and RoHS Compliant Models		Disc Diameter	Maximum Rating (85°C)					Specifications (25°C)				
Part Number	Branding	Part Number	Branding		Continuous		Transient			Varistor Voltage at 1mA Test Current		Maximum Clamping Voltage 8/20 μ s		Typical Capacitance f = 1MHz
					$V_{M(AC)RMS}$	$V_{M(DC)}$	W_{TM}	$I_{TM} 1 \times$ Pulse	$I_{TM} 2 \times$ Pulse	$V_{N(DC)}$ Min	$V_{N(DC)}$ Max	V_C	I_{PK}	C
(mm)	(V)	(V)	(J)	(A)	(A)	(V)	(V)	(A)	(pF)					
TMOV14RP115E	P4T115E	TMOV14RP115M	P4T115M	14	115	150	35	6000	4500	162	198	300	50	1100
TMOV20RP115E	P2T115E	TMOV20RP115M	P2T115M	20	115	150	52	10000	6500	162	198	300	100	2400
TMOV14RP130E	P4T130E	TMOV14RP130M	P4T130M	14	130	170	50	6000	4500	184.5	225.5	340	50	1000
TMOV20RP130E	P2T130E	TMOV20RP130M	P2T130M	20	130	170	100	10000	6500	184.5	225.5	340	100	1900
TMOV14RP140E	P4T140E	TMOV14RP140M	P4T140M	14	140	180	55	6000	4500	198	242	360	50	900
TMOV20RP140E	P2T140E	TMOV20RP140M	P2T140M	20	140	180	110	10000	6500	198	242	360	100	1750
TMOV14RP150E	P4T150E	TMOV14RP150M	P4T150M	14	150	200	60	6000	4500	216	264	395	50	800
TMOV20RP150E	P2T150E	TMOV20RP150M	P2T150M	20	150	200	120	10000	6500	216	264	395	100	1600
TMOV14RP175E	P4T175E	TMOV14RP175M	P4T175M	14	175	225	70	6000	4500	243	297	455	50	700
TMOV20RP175E	P2T175E	TMOV20RP175M	P2T175M	20	175	225	135	10000	6500	243	297	455	100	1400
TMOV14RP200E	P4T200E	TMOV14RP200M	P4T200M	14	200	260	75	6000	4500	283	345	530	50	630
TMOV20RP200E	P2T200E	TMOV20RP200M	P2T200M	20	200	260	154	10000	6500	283	345	530	100	1250
TMOV14RP230E	P4T230E	TMOV14RP230M	P4T230M	14	230	300	80	6000	4500	324	396	595	50	550
TMOV20RP230E	P2T230E	TMOV20RP230M	P2T230M	20	230	300	160	10000	6500	324	396	595	100	1100
TMOV14RP250E	P4T250E	TMOV14RP250M	P4T250M	14	250	320	100	6000	4500	351	429	650	50	500
TMOV20RP250E	P2T250E	TMOV20RP250M	P2T250M	20	250	320	170	10000	6500	351	429	650	100	1000
TMOV14RP275E	P4T275E	TMOV14RP275M	P4T275M	14	275	350	110	6000	4500	387	473	710	50	450
TMOV20RP275E	P2T275E	TMOV20RP275M	P2T275M	20	275	350	190	10000	6500	387	473	710	100	900
TMOV14RP300E	P4T300E	TMOV14RP300M	P4T300M	14	300	385	125	6000	4500	423	517	775	50	400
TMOV20RP300E	P2T300E	TMOV20RP300M	P2T300M	20	300	385	250	10000	6500	423	517	775	100	800
TMOV14RP320E	P4T320E	TMOV14RP320M	P4T320M	14	320	420	136	6000	4500	459	561	840	50	380
TMOV20RP320E	P2T320E	TMOV20RP320M	P2T320M	20	320	420	270	10000	6500	459	561	840	100	750
TMOV14RP385E	P4T385E	TMOV14RP385M	P4T385M	14	385	505	150	6000	4500	558	682	1025	50	360
TMOV20RP385E	P2T385E	TMOV20RP385M	P2T385M	20	385	505	300	10000	6500	558	682	1025	100	700
TMOV14RP420E	P4T420E	TMOV14RP420M	P4T420M	14	420	560	160	6000	4500	612	748	1120	50	300
TMOV20RP420E	P2T420E	TMOV20RP420M	P2T420M	20	420	560	320	10000	6500	612	748	1120	100	600
TMOV14RP460E	P4T460E	TMOV14RP460M	P4T460M	14	460	610	180	6000	4500	675	825	1240	50	220
TMOV20RP460E	P2T460E	TMOV20RP460M	P2T460M	20	460	610	360	10000	6500	675	825	1240	100	200
TMOV14RP510E	P4T510E	TMOV14RP510M	P4T510M	14	510	670	185	6000	4500	738	902	1355	50	200
TMOV20RP510E	P2T510E	TMOV20RP510M	P2T510M	20	510	670	325	10000	6500	738	902	1355	100	350
TMOV14RP550E	P4T550E	TMOV14RP550M	P4T550M	14	550	715	190	6000	4500	819	1001	1500	50	180
TMOV20RP550E	P2T550E	TMOV20RP550M	P2T550M	20	550	715	360	10000	6500	819	1001	1500	100	300

Ratings & Specifications

TMOV® Varistor Lead-free And RoHS Compliant Models		iTMOV® Varistor Lead-free and RoHS Compliant Models		Disc Diameter	Maximum Rating (85°C)					Specifications (25°C)				
Part Number	Branding	Part Number	Branding		Continuous		Transient			Varistor Voltage at 1mA Test Current		Maximum Clamping Voltage 8/20µs		Typical Capacitance f = 1MHz
					AC Volts	DC Volts	Energy 2ms	Peak Surge Current 8/20µs	V _{N(DC)} Min	V _{N(DC)} Max	V _C	I _{PK}	C	
				(mm)	V _{MACIRMS} (V)	V _{M(DC)} (V)	W _{TM} (J)	I _{TM 1x} Pulse (A)	I _{TM 2x} Pulse (A)	V _{N(DC)} (V)		V _C (V)	I _{PK} (A)	C (pF)
TMOV14RP575E	P4T575E	TMOV14RP575M	P4T575M	14	575	730	195	6000	4500	857	1047	1568	50	170
TMOV20RP575E	P2T575E	TMOV20RP575M	P2T575M	20	575	730	375	10000	6500	857	1047	1568	100	275
TMOV14RP625E	P4T625E	TMOV14RP625M	P4T625M	14	625	825	200	6000	4500	900	1100	1650	50	160
TMOV20RP625E	P2T625E	TMOV20RP625M	P2T625M	20	625	825	400	10000	6500	900	1100	1650	100	250
TMOV14RP750E	P4T750E	TMOV14RP750M	P4T750M	14	750	970	210	6000	4500	1080	1320	1980	50	140
TMOV20RP750E	P2T750E	TMOV20RP750M	P2T750M	20	750	970	480	10000	6500	1080	1320	1980	100	175

Thermal Characteristics

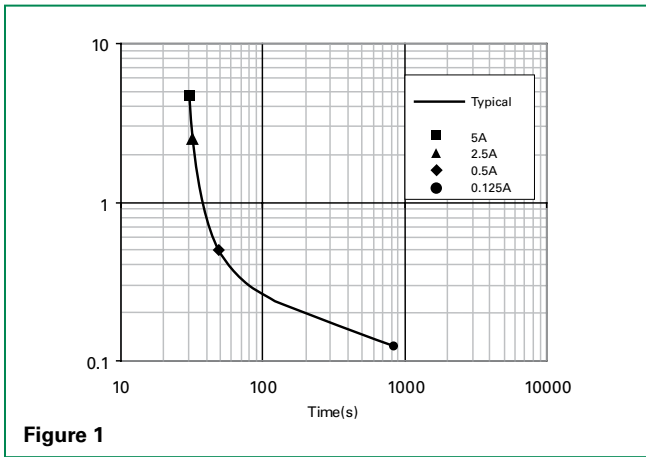

Current, Energy, Power Derating Curve

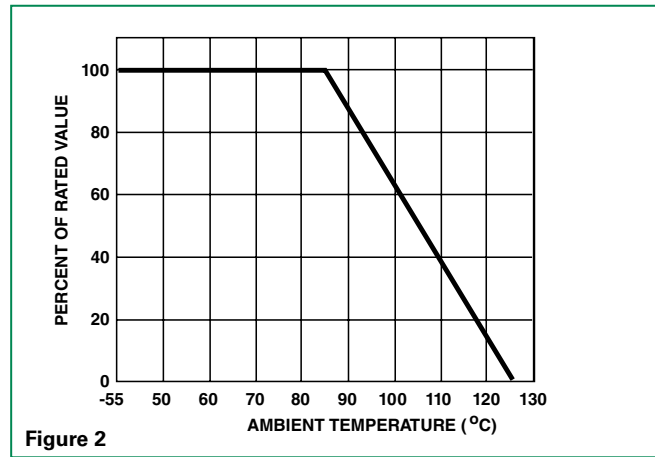

Note : The TMOV® and iTMOV® varistors are intended, in conjunction with appropriate enclosure design, to help facilitate SPD module compliance to UL 1449, 3rd Edition Section 39.4 (abnormal overvoltage limited current requirements). Under these extreme abnormal overvoltage conditions, some units will exhibit substantial heating, arcing and venting prior to opening. Modules should be designed to contain this possibility. Application testing is strongly recommended.

For applications exceeding 85°C ambient temperature, the peak surge current and energy ratings must be reduced as shown above.

Maximum Clamping Voltage for 14mm Parts

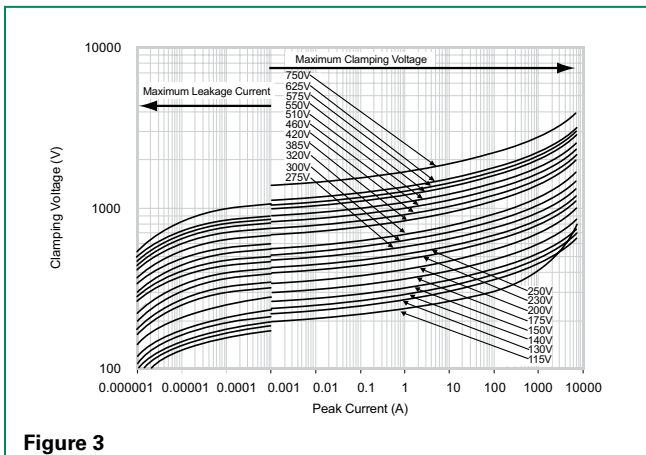

Maximum Clamping Voltage for 20mm Parts

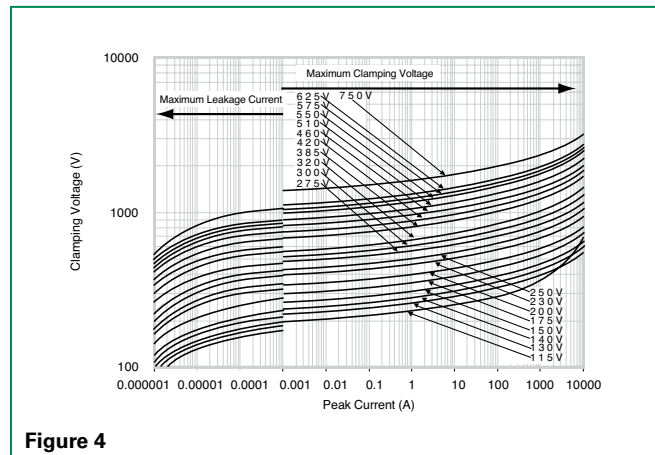

Repetitive Surge Capability for 14mm Parts

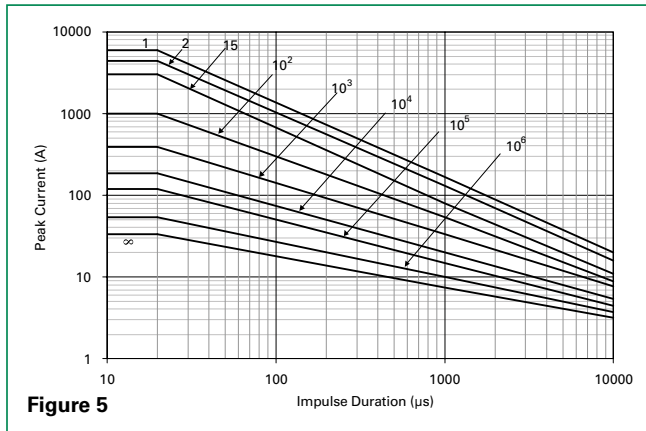

Figure 5

NOTE: Average power dissipation of transients should not exceed 0.6W

Repetitive Surge Capability for 20mm Parts

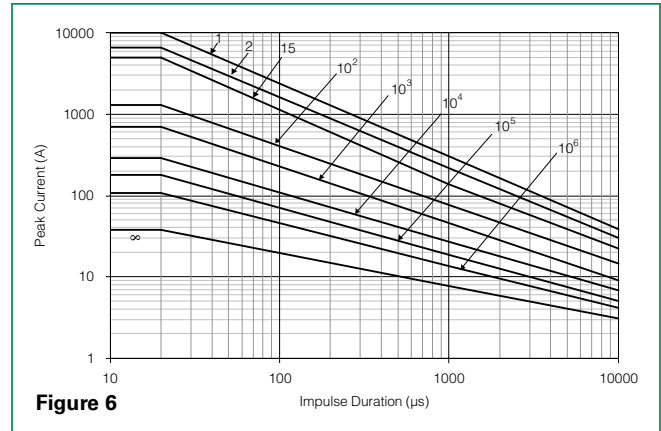

Figure 6

NOTE: Average power dissipation of transients should not exceed 1.0W

Wave Solder Profile

Because the TMOV® and iTMOV® varistors contain a thermal protection device, care must be taken when soldering the devices into place. Two soldering methods are possible. Firstly, hand soldering: It is recommended to heat-sink the leads of the device. Secondly, wave soldering: It is critically important that all preheat stage and the solder bath temperatures are rigidly controlled.

Non Lead-free Profile

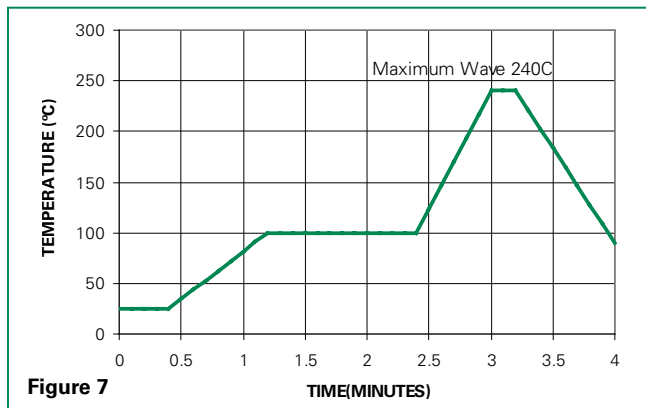

Figure 7

Lead-free Profile

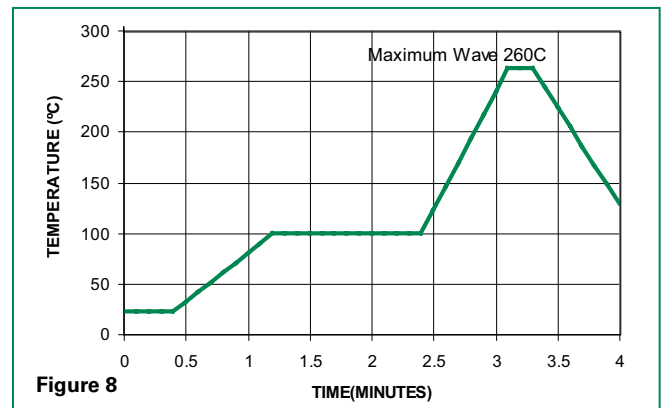

Figure 8

Physical Specifications

Lead Material	Copper clad steel wire
Soldering Characteristics	Solderability per MIL-STD-202, Method 208
Insulating Material	Cured, flame retardant epoxy polymer meets UL94 V-0 requirements
Device Labeling	Marked with LF, voltage, UL/CSA logos, and date code

Environmental Specifications

Operating/Storage Temperature	-55°C to +85°C
Humidity Aging	+85°C, 85% RH, 1000 hours +/-10% typical voltage change
Thermal Shock	+85°C to -55°C 5 times +/-10% typical voltage change
Solvent Resistance	MIL-STD-202, Method 215
Moisture Sensitivity	Level 1, J-STD-020

Lead Configurations

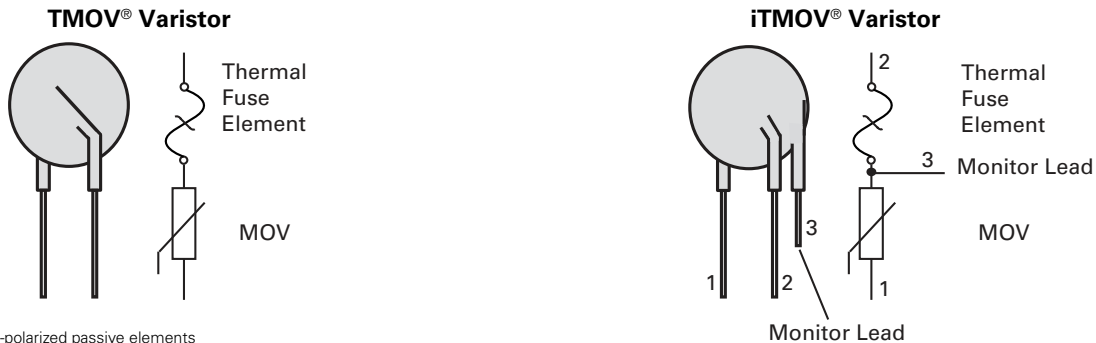

Note: MOVs are non-polarized passive elements

iTMOV® Varistor Application Examples

The application examples below show how the indicator lead on the iTMOV® varistor can be used to indicate that the thermal element has been opened. This signifies that the circuit is no longer protected from transients by the MOV.

Application Example 1

In this case, the LED is normally on, and is off when the thermal element opens.

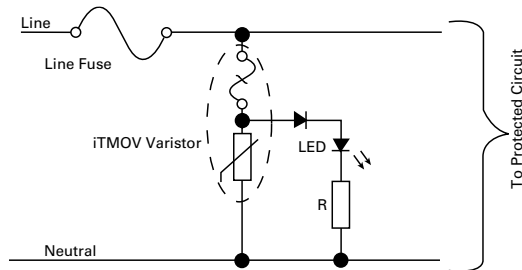

Application Example 2

This circuit utilizes an optocoupler to provide galvanic isolations between the iTMOV® varistor and the indicating or alarm circuitry.

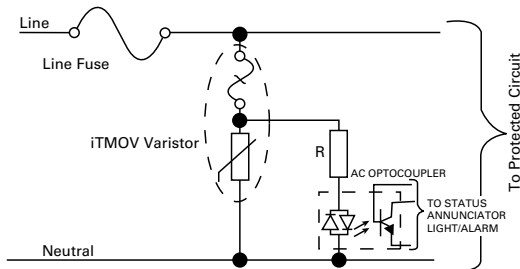

Application Example 3

This circuit illustrates the use of the monitoring lead of the iTMOV® varistor to ensure that equipment is only operated when overvoltage protection is present. In normal operation the load switch relay solenoid is powered via the indicator lead of the iTMOV® varistor. In the event of the thermal element being activated, the relay will de-activate, cutting power to the protected circuit and the fault LED will illuminate.

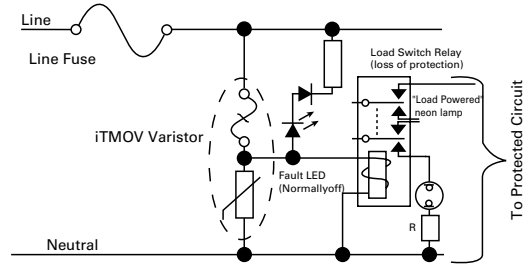

Please note: Indicator circuits are provided as a guideline only. Verification of actual indicator circuitry is the responsibility of the end user. Component values selected must be appropriate for the specific AC line voltage service and application.

Device Dimensions

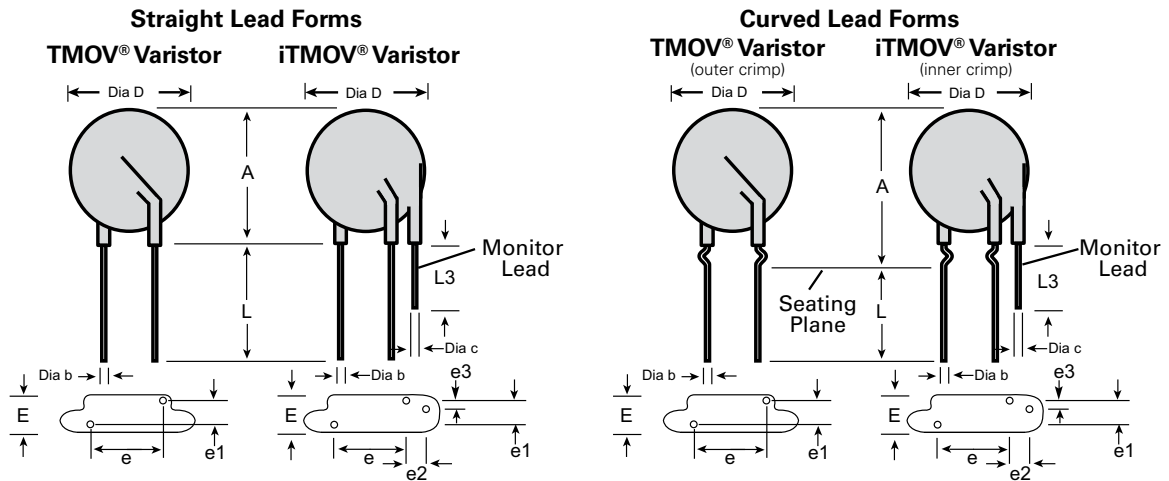

Dimension	V _{RMS} Voltage Model	TMOV [®] Varistor				iTMOV [®] Varistor			
		14mm Size		20mm Size		14mm Size		20mm Size	
		Min. mm (in)	Max. mm (in)	Min. mm (in)	Max. mm (in)	Min. mm (in)	Max. mm (in)	Min. mm (in)	Max. mm (in)
A Straight Lead	ALL	17.0 (0.669)	22.0 (0.866)	23.0 (0.906)	28.0 (1.10)	17.0 (0.669)	22.0 (0.866)	23.0 (0.906)	28.0 (1.10)
A Crimped Lead	ALL	--	22.5 (0.886)	--	31.0 (1.221)	--	22.5 (0.886)	--	31.0 (1.221)
Dia D	ALL	13.5 (0.531)	17.0 (0.669)	19.0 (0.748)	23.0 (0.906)	13.5 (0.531)	17.0 (0.669)	19.0 (0.748)	23.0 (0.906)
e	ALL	6.5 (0.256)	8.5 (0.335)	6.5 (0.256)	8.5 (0.335)	6.5 (0.256)	8.5 (0.335)	6.5 (0.256)	8.5 (0.335)
e1 Bulk Pack	115-175	1.5 (0.059)	4.0 (0.157)	1.5 (0.059)	4.0 (0.157)	1.5 (0.059)	4.0 (0.157)	1.5 (0.059)	4.0 (0.157)
	200-275	2.0 (0.079)	4.5 (0.177)	2.0 (0.079)	4.5 (0.177)	2.0 (0.079)	4.5 (0.177)	2.0 (0.079)	4.5 (0.177)
	300-420	3.0 (0.118)	5.5 (0.217)	3.0 (0.118)	5.5 (0.217)	3.0 (0.118)	5.5 (0.217)	3.0 (0.118)	5.5 (0.217)
	460-750	0	2.0 (0.079)	0	2.0 (0.079)	0	2.0 (0.079)	0	2.0 (0.079)
e1 Tape & Reel and In-Line Lead	115-420	0	2.0 (0.079)	0	2.0 (0.079)	0	2.0 (0.079)	0	2.0 (0.079)
	460-550*	0	2.0 (0.079)	0	2.0 (0.079)	0	2.0 (0.079)	0	2.0 (0.079)
e2	ALL	n/a	n/a	n/a	n/a	4.0 (0.157)	6.0 (0.236)	4.0 (0.157)	6.0 (0.236)
e3	ALL	n/a	n/a	n/a	n/a	0	2.0 (0.079)	0	2.0 (0.079)
E	115-175	--	9.0 (0.354)	--	9.0 (0.354)	--	9.0 (0.354)	--	9.0 (0.354)
	200-275	--	9.5 (0.374)	--	9.5 (0.374)	--	9.5 (0.374)	--	9.5 (0.374)
	300-460	--	11.0 (0.433)	--	11.0 (0.433)	--	11.0 (0.433)	--	11.0 (0.433)
	510-575	--	12.0 (0.472)	--	12.0 (0.472)	--	12.0 (0.472)	--	12.0 (0.472)
	625-750	--	13.0 (0.512)	--	13.0 (0.512)	--	13.0 (0.512)	--	13.0 (0.512)
L	ALL	25.4 (1.00)	--	25.4 (1.00)	--	25.4 (1.00)	--	25.4 (1.00)	--
L3	ALL	n/a	n/a	n/a	n/a	6.0 (0.236)	--	6.0 (0.236)	--
Dia b	115-420	0.76 (0.030)	0.86 (0.034)	0.76 (0.030)	0.86 (0.034)	0.76 (0.030)	0.86 (0.034)	0.76 (0.030)	0.86 (0.034)
	460-750	0.76 (0.030)	0.86 (0.034)	0.95 (0.037)	1.05 (0.041)	0.76 (0.030)	0.86 (0.034)	0.95 (0.037)	1.05 (0.041)
Dia c Outside Lead Only	ALL	n/a	n/a	n/a	n/a	0.76 (0.030)	0.86 (0.034)	0.76 (0.030)	0.86 (0.034)

NOTES:

* Tape and Reel packaging option is available only for devices up to 420Vrms.

Tape and Reel Specification

iTMOV® VARISTOR WITH INNER CRIMP

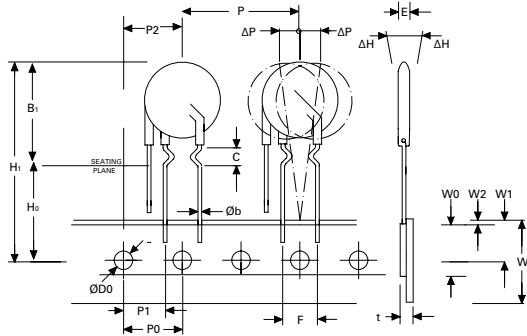

TMOV® VARISTOR WITH OUTER CRIMP

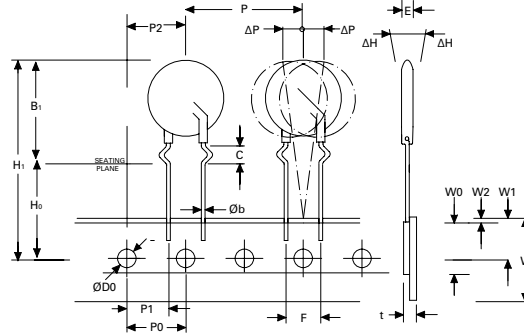

iTMOV® VARISTOR WITH STRAIGHT LEADS

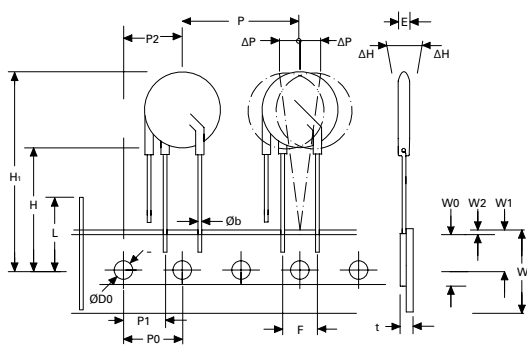

TMOV® VARISTOR WITH STRAIGHT LEADS

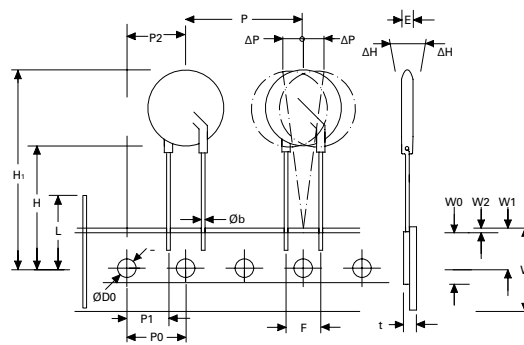

	DESCRIPTION	CRIMPED LEADS		STRAIGHT LEADS	
		MODEL SIZE		MODEL SIZE	
		14mm	20mm	14mm	20mm
B₁	Component Top to Seating Plane	22.5 Max	31 Max	22.0 Max	28.0 Max
P	Pitch of Component	25.4 +/- 1.0	25.4 +/- 1.0	25.4 ±1.0	25.4 ±1.0
P₀	Feed Hole Pitch	12.7 +/- 0.2	12.7 +/- 0.2	12.7 ±0.2	12.7 ±0.2
P₁	Feed Hole Center to Pitch	8.95 +/- 0.7	8.95 +/- 0.7	8.95 ±0.7	8.95 ±0.7
P₂	Hole Center to Component Center	12.7 +/- 0.7	12.7 +/- 0.7	12.7 ±0.7	12.7 ±0.7
F	Lead to Lead Distance	75 +/- 0.8	75 +/- 0.8	75 ±0.8	75 ±0.8
Δh	Component Alignment	2.0 Max	2.0 Max	2.0 Max	2.0 Max
W	Tape Width	18.0 +1.0/-0.5	18.0 +1.0/-0.5	18.0 +1.0/-0.5	18.0 +1.0/-0.5
W₀	Hold Down Tape Width	12.0 +/- 0.3	12.0 +/- 0.3	12.0 ±0.3	12.0 ±0.3
W₁	Hole Position	9.0 +0.75/-0.50	9.0 +0.75/-0.50	9.0 +0.75/-0.5	9.0 +0.75/-0.5
W₂	Hold Down Tape Position	0.5 Max	0.5 Max	0.5 Max	0.5 Max
H	Height from Tape Centre to Component Base (non-crimped parts)	–	–	18.0 +2.0/0	18.0 +2.0/0
H₀	Seating Plane Height (crimped parts only)	16.0 +/- 0.5	16.0 +/- 0.5	–	–
H₁	Component Height	40.0 Max	46.5 Max	40.0 Max	46.5 Max
C	Crimp Length (crimped parts only)	2.6 typ	2.6 typ	–	–
D₀	Feed Hole Diameter	4.0 +/- 0.2	4.0 +/- 0.2	4.0 ±0.2	4.0 ±0.2
t	Total Tape Thickness	0.7 +/- 0.2	0.7 +/- 0.2	0.7 ±0.2	0.7 ±0.2
L	Length of Clipped Lead	11.0 Max	11.0 Max	11.0 Max	11.0 Max
Δp	Component Alignment	3 Max. 1.00mm	3 Max	3 deg Max, 1.0mm Max	3 deg Max, 1.0mm Max

NOTES:

- Dimensions in mm
- Reel capacity varies with voltage.
- Leads are crimped and in-line. This excludes the monitor lead on iTMOV® varistor which are not crimped and not in-line.
- To order tape and reel option please add suffix 'L2T7' to end of standard part number.
- Tape and reel option is available for rated voltages up to 420V. Contact factory regarding availability of higher voltages.
- Contact Littelfuse for additional details.

Part Numbering System

Base Part Codes
 (See ratings & specifications tables and notes below)

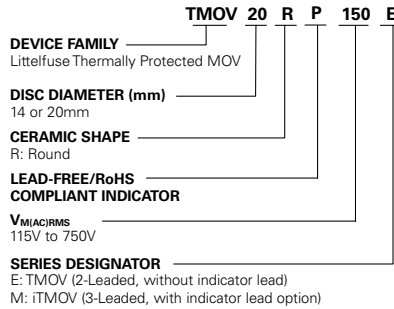

NOTES:

- Use Base Part Code only to receive standard product:
 Lead Form: Straight Leads. Devices greater than 420Vrms are provided In-Line².
 Packaging: Bulk Pack
 Lead Spacing: 7.5mm +/-1.0mm
- "In-Line" refers to straight row of leads at the tip where product is to contact the circuit board. Refer to "e1" in Device Dimensions section.
- Lead Spacing refers to span between leads as "e" dimension in Device Dimensions section.
- Due to device bulk, tape and reel packaging option is available only for devices up to 420Vrms.

Option Codes¹
 (See below)

XXXXX

NON-STANDARD LEAD FORM, PACKAGING and LEAD SPACING OPTIONS³:

- L2B7:** Lead Form: Crimped and In-Line² Leads
 Packaging: Bulk Pack
 Lead Spacing³: 7.5mm
- L2T7:** Lead Form: Crimped and In-Line² Leads
 Packaging: Tape and Reel⁴
 Lead Spacing³: 7.5mm
- L3T7:** Lead Form: Straight Leads and In-Line² Leads
 Packing: Tape and Reel
 Lead Spacing: 7.5mm

Option Codes:

X2855: Nickel Barrier coated wire option –
 All standard parts use tinned copper clad steel wire. Nickel Barrier coated wire is available as an option, consisting of Copper wire with a flashing of Nickel followed by a top coating of Tin. To order append standard model BASE PART number with "X2855." Example:

Standard Model	Order As
TMOV20RP115E	TMOV20RP115EX2855

Other non-standard options may be available - please contact Littelfuse.

Pack Quantities

Rated Voltage	Pack Quantities			
	Bulk Pack		Tape and Reel	
	Model Size		Model Size	
	14mm	20mm	14mm	20mm
115-250	600	400	500	400
275-550	500	300	400	300
575-750	400	200	n/a	n/a

NOTE: Tape and Reel available up to 420V only - please contact factory regarding availability of higher voltage parts.

Disclaimer Notice - Information furnished is believed to be accurate and reliable. However, users should independently evaluate the suitability of and test each product selected for their own applications. Littelfuse products are not designed for, and may not be used in, all applications. Read complete Disclaimer Notice at www.littelfuse.com/disclaimer-electronics.

TMOV[®]25S Varistor Series

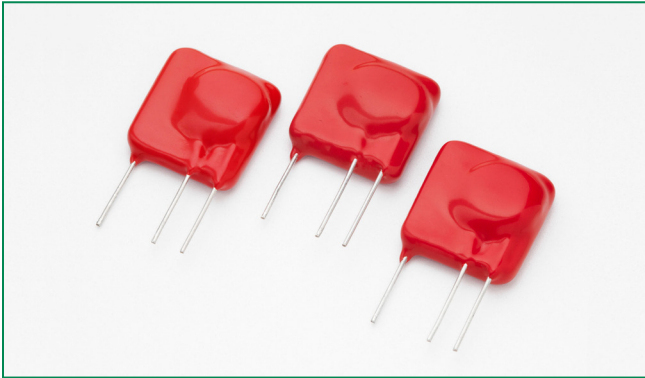

Description

Metal Oxide Varistors (MOVs) are rated for specific AC line operating voltages, and exceeding these limits through the application of a sustained abnormal over-voltage condition could result in overheating and damage to the MOV.

The Littelfuse TMOV[®]25S Varistor Series was designed to address this condition in a single integrated package.

The TMOV[®]25S Varistor Series incorporates a patented integrated thermally responsive element within the body of the device which will open-circuit the varistor in case of overheating due to the abnormal over-voltage events.

The TMOV[®]25S Varistor Series meets the surge suppressor component recognition requirements of UL1449 3rd edition for both cord connected and permanently connected SPD end products.

Agency Approvals

Agency	Agency Approval	Agency File Number
	UL1449	E320116
	IEC-CECC Spec: QC42201-C001, QC42201-A001, IEC 60950-1 (Annex Q)	E1274/F
	IEC 61051-1, IEC 61051-2, IEC 60950-1 (Annex Q)	40021525

Features

- RoHS Compliant and Lead-free
- Wave solderable
- Standard Operating Voltage Range Compatible with Common AC Line Voltages (115VAC to 750VAC)
- High peak surge current rating up to 20kA at single 8/20μS impulse
- Standard lead form and spacing option
- -55°C to +85°C operating temperature range

Additional Information



Datasheet



Resources



Samples

Applications

- SPD Products
- AC Panel Protection Modules
- AC/DC power supplies
- UPS (Uninterruptible Power Supply)

Absolute Maximum Ratings

• For ratings of individual members of a series, see Device Ratings and Specifications chart.

	TMOV [®] 25S Varistor Series	Units
Continuous:		
AC Voltage Range ($V_{M(AC)RMS}$)	115 to 750	V
Transient:		
Peak Pulse Current (I_{TM})		
For 8x20 μ s Current Wave, single pulse	20,000	A
Single-Pulse Energy Capability		
For 2ms Current Wave	170 to 670	J
Operating Ambient Temperature Range (T_A)	-55 to +85	°C
Storage Temperature Range (T_{STG})	-55 to +125	°C
Temperature Coefficient (α_V) of Clamping Voltage (V_C) at Specified Test Current	<0.01	%/°C
Hi-Pot Encapsulation (COATING Isolation Voltage Capability)	2,500	V
Thermal Protection Isolation Voltage Capability (when operated)	600*	V
*See notes under Device Ratings & Specifications section for more information		
COATING Insulation Resistance	1,000	M Ω

CAUTION: Stresses above those listed in "Absolute Maximum Ratings" may cause permanent damage to the device. This is a stress only rating and operation of the device at these or any other conditions above those indicated in the operational sections of this specification is not implied.

Device Ratings & Specifications

2 Leaded Device - Without Indicator Lead		3 Leaded Device - With Indicator Lead Option		Model Size Disc Diameter (mm)	Maximum Rating (85°C)				Specifications (25 °C)			
					Continuous		Transient		Varistor Voltage at 1mA Test Current		Clamping Voltage at 100A Current 8/20 μ s	Typical Capacitance (f=1MHz)
Part Number	Branding	Part Number	Branding		AC Volts $V_{M(AC)RMS}$	DC Volts $V_{M(DC)}$	Energy 2ms W_{TM}	Peak Current 8/20 μ s $I_{TM} \times 1 \times$ Pulse	$V_{N(DC)}$ Min	$V_{N(DC)}$ Max	V_C	C
					(V)	(V)	(J)	(A)	(V)	(V)	(V)	(pF)
TMOV25SP115E	P25T115E	TMOV25SP115M	P25T115M	25	115	150	170	20000	162	198	295	3200
TMOV25SP130E	P25T130E	TMOV25SP130M	P25T130M	25	130	170	190	20000	184.5	225.5	335	2800
TMOV25SP140E	P25T140E	TMOV25SP140M	P25T140M	25	140	180	210	20000	198	242	355	2500
TMOV25SP150E	P25T150E	TMOV25SP150M	P25T150M	25	150	200	220	20000	216	264	390	2300
TMOV25SP175E	P25T175E	TMOV25SP175M	P25T175M	25	175	225	250	20000	243	297	450	1900
TMOV25SP200E	P25T200E	TMOV25SP200M	P25T200M	25	200	265	270	20000	283	345	530	1700
TMOV25SP230E	P25T230E	TMOV25SP230M	P25T230M	25	230	300	300	20000	324	396	585	1500
TMOV25SP250E	P25T250E	TMOV25SP250M	P25T250M	25	250	320	330	20000	351	429	640	1400
TMOV25SP275E	P25T275E	TMOV25SP275M	P25T275M	25	275	350	350	20000	387	473	700	1250
TMOV25SP300E	P25T300E	TMOV25SP300M	P25T300M	25	300	385	370	20000	423	517	765	1150
TMOV25SP320E	P25T320E	TMOV25SP320M	P25T320M	25	320	420	390	20000	459	561	825	1080
TMOV25SP385E	P25T385E	TMOV25SP385M	P25T385M	25	385	505	430	20000	558	682	1010	900
TMOV25SP420E	P25T420E	TMOV25SP420M	P25T420M	25	420	560	460	20000	612	748	1100	820
TMOV25SP440E	P25T440E	TMOV25SP440M	P25T440M	25	440	585	470	20000	643.5	786.5	1160	790
TMOV25SP460E	P25T460E	TMOV25SP460M	P25T460M	25	460	615	490	20000	675	825	1220	750
TMOV25SP510E	P25T510E	TMOV25SP510M	P25T510M	25	510	670	520	20000	738	902	1335	680
TMOV25SP550E	P25T550E	TMOV25SP550M	P25T550M	25	550	745	550	20000	819	1001	1475	630
TMOV25SP625E	P25T625E	TMOV25SP625M	P25T625M	25	625	825	600	20000	900	1100	1625	550
TMOV25SP750E	P25T750E	TMOV25SP750M	P25T750M	25	750	970	670	20000	1080	1320	1950	460

Notes:
Average power dissipation of transients should not exceed 1.5 watts.

Thermal Characteristics

Typical time to open circuit under UL 1449 Abnormal Overvoltage Limited Current Test:

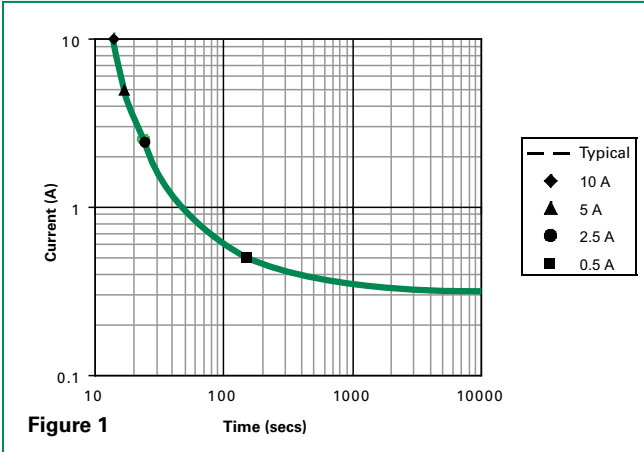

Figure 1

Peak Current & Energy Derating Curve

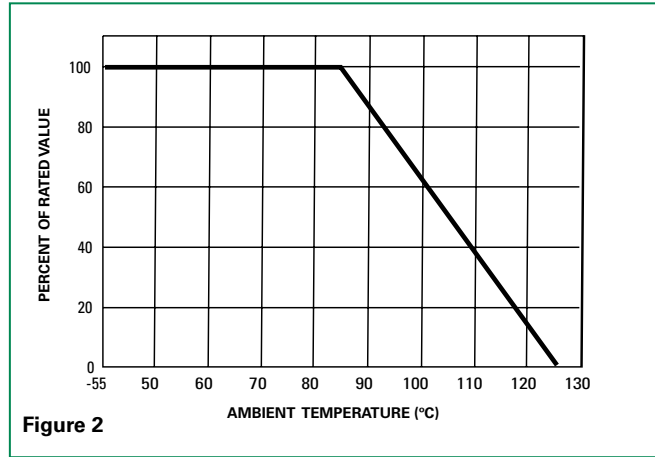

Figure 2

For applications exceeding 85°C ambient temperature, the peak surge current and energy ratings must be reduced as shown.

Transient V-I Characteristic Curves

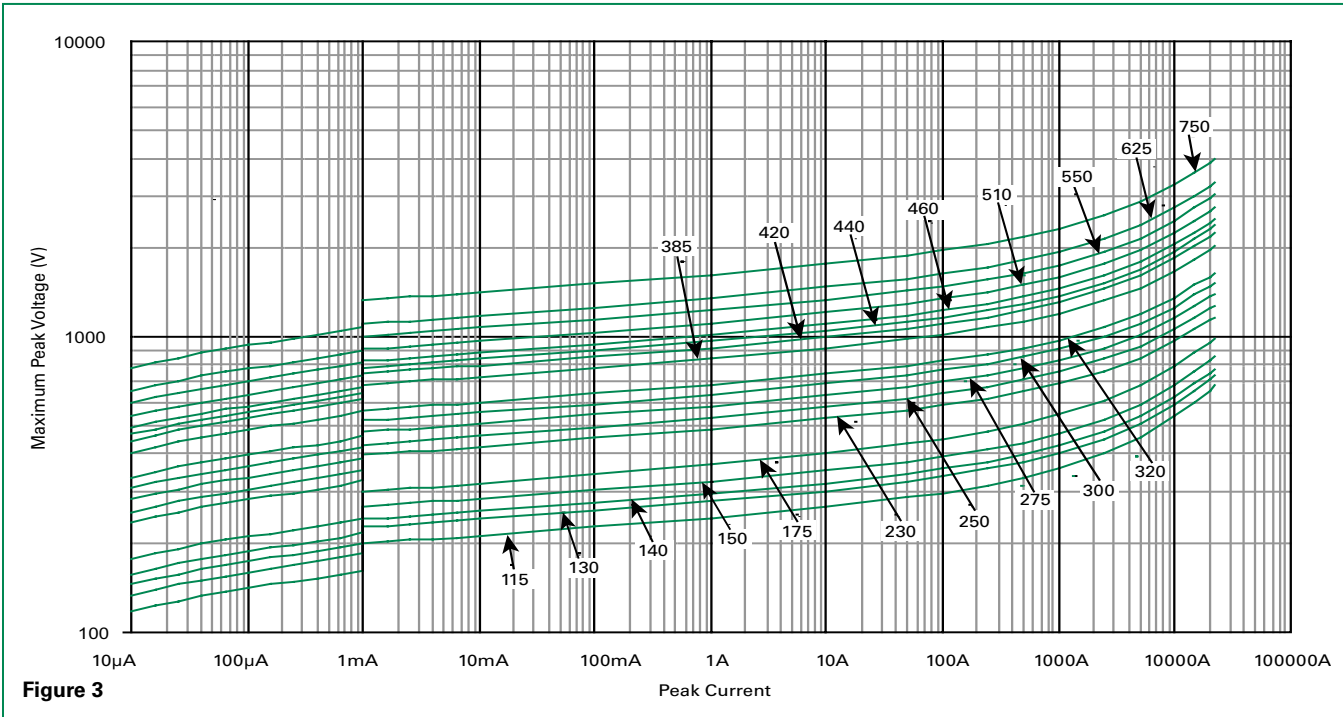
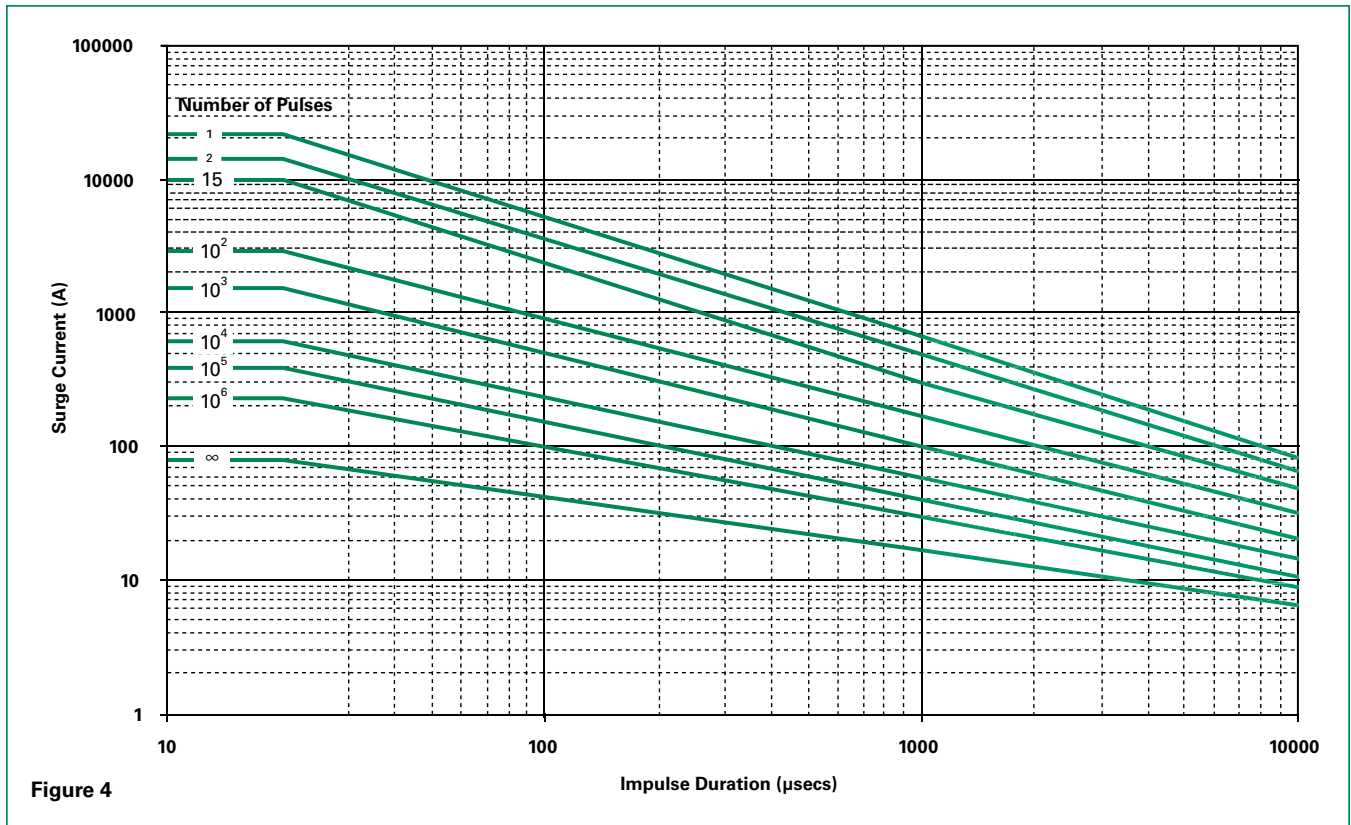

Figure 3

Pulse Rating Curve



Wave Solder Profile

Because the TMOV®25S Varistor Series contains a thermally responsive device, care must be taken when soldering the device into place. Two soldering methods are possible. Firstly, hand soldering: We recommend the use of pliers to heat-sink the leads of the device. Secondly, wave-soldering: This is a strenuous process requiring pre-heat stages to reduce the stresses on devices.

It is critically important that all preheat stage and the solder bath temperatures are rigidly controlled. The recommended solder for the TMOV® Varistor Series is a 62/36/2 (Sn/Pb/Ag), 60/40 (Sn/Pb) or 63/37 (Sn/Pb). Littelfuse also recommends an RMA solder flux. SAC solders (SnAgCu) are recommended for Lead-free applications.

Soldering Profile

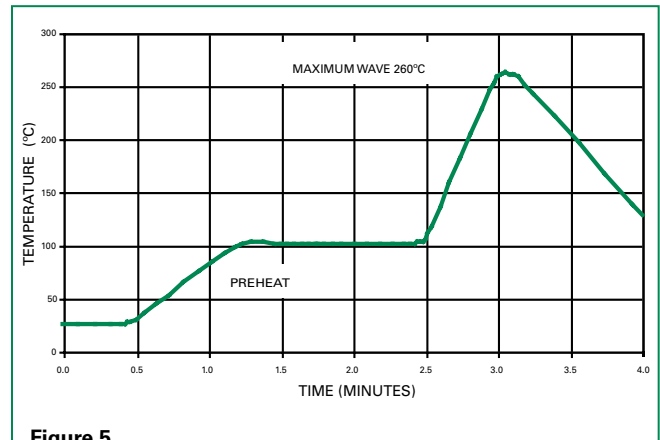

Physical Specifications

Lead Material	Tin-coated Copper wire
Soldering Characteristics	Solderability per MIL-STD-202, Method 208
Insulating Material	Cured, flame retardant epoxy polymer meets UL94V-0 requirements
Device Labeling	Marked with LF, voltage, UL logos, and date code

Environmental Specifications

Operating/Storage Temperature	-55°C to +85°C
Humidity Aging	+85°C, 85% R.H., 1000 hours -/+10% typical voltage change
Thermal Shock	+85°C to -40°C 5 times -/+10% typical voltage change
Solvent Resistance	MIL-STD-202, Method 215
Moisture Sensitivity	Level 1, J-STD-020

Application Example

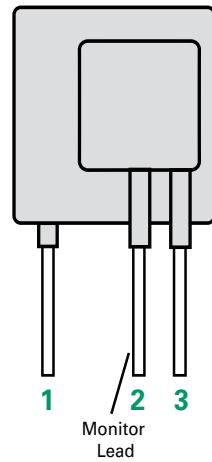
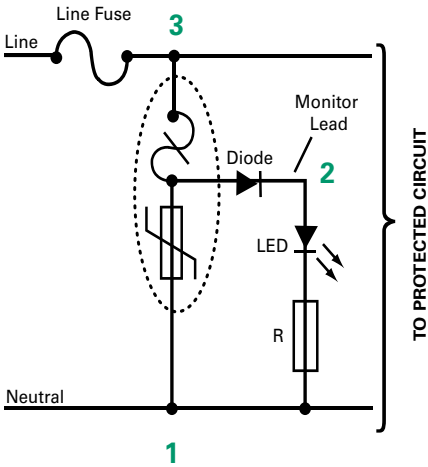

The application example left shows how the indicator lead on the TMOV® Varistor can be used to indicate that thermal element has been opened. This signifies that the circuit is no longer protected from transients by the MOV.

Dimensions

2 Leaded Device
Without Indicator Lead
(E part number suffix)

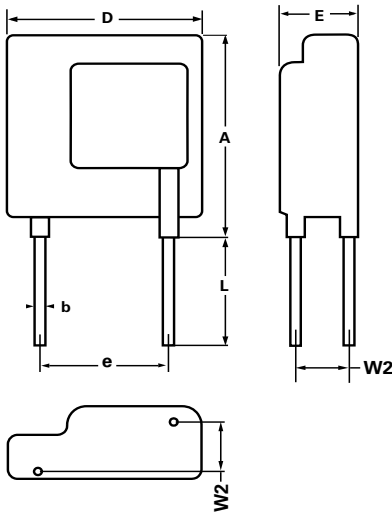

3 Leaded Device
With Indicator Lead Option
(M part number suffix)

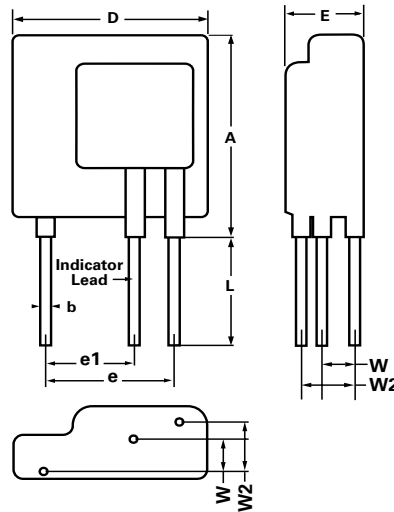

Product Dimensions (mm)

Part Number	Part Number	W _{MIN}	W _{MAX}	W2	E _{MAX}	A _{MAX}	b _{MIN}	b _{MAX}	D _{MAX}	e	e1	L
TMOV25SP115E	TMOV25SP115M	1.5	2.7	3.6+/-1	11.7	34.5	0.95	1.05	28	19.2 +/-1	12.7 +/-1	12.7 Min.
TMOV25SP130E	TMOV25SP130M	1.6	2.9	3.7+/-1	11.9							
TMOV25SP140E	TMOV25SP140M	1.7	3.0	3.8+/-1	12.0							
TMOV25SP150E	TMOV25SP150M	1.8	3.1	3.9+/-1	12.1							
TMOV25SP175E	TMOV25SP175M	1.9	3.3	4.1+/-1	12.3							
TMOV25SP200E	TMOV25SP200M	1.9	3.3	4.1+/-1	12.3							
TMOV25SP230E	TMOV25SP230M	2.0	3.4	4.2+/-1	12.4							
TMOV25SP250E	TMOV25SP250M	2.1	3.5	4.3+/-1	12.5							
TMOV25SP275E	TMOV25SP275M	2.3	3.7	4.5+/-1	12.7							
TMOV25SP300E	TMOV25SP300M	2.4	3.9	4.6+/-1	12.9							
TMOV25SP320E	TMOV25SP320M	2.6	4.1	4.8+/-1	13.1							
TMOV25SP385E	TMOV25SP385M	3.0	4.7	5.3+/-1	13.7							
TMOV25SP420E	TMOV25SP420M	3.3	5.0	5.6+/-1	14.0							
TMOV25SP440E	TMOV25SP440M	3.4	5.2	5.8+/-1	14.2							
TMOV25SP460E	TMOV25SP460M	3.6	5.4	6+/-1	14.4							
TMOV25SP510E	TMOV25SP510M	3.9	5.7	6.3+/-1	14.7							
TMOV25SP550E	TMOV25SP550M	4.2	6.2	6.7+/-1	15.2							
TMOV25SP625E	TMOV25SP625M	4.6	6.6	7.1+/-1	15.6							
TMOV25SP750E	TMOV25SP750M	5.4	7.7	8.0+/-1	16.7							

Part Numbering System

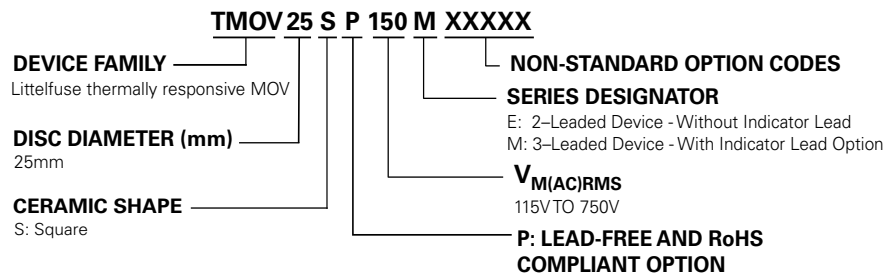

Disclaimer Notice - Information furnished is believed to be accurate and reliable. However, users should independently evaluate the suitability of and test each product selected for their own applications. Littelfuse products are not designed for, and may not be used in, all applications. Read complete Disclaimer Notice at www.littelfuse.com/disclaimer-electronics.



TMOV®34S Varistor Series



Description

The Littelfuse TMOV®34S thermally protected varistor series consists of a 34mm square format varistor element (MOV) with an integral thermally activated element. This element is designed to open in the event of overheating due to abnormal overvoltage, limited current conditions. Certain TMOV®34S varistor are offered with a "monitor" lead which may be connected to signalling circuitry to indicate if the MOV has been disconnected from the circuit. TMOV®34S varistor series offer quick thermal response due to the close proximity of the integrated thermal element to the MOV body. The integrated configuration also offers lower inductance than most discrete solutions resulting in improved clamping performance to fast over voltage transients.

Agency Approvals

Agency	Standard	Agency File Number
	UL1449	E320116
	QC42201-C001, QC42201-A001, IEC 60950-1 (Annex Q)	IECQ-C BSI 15.0009
	IEC 61051-1, IEC 61051-2, IEC 60950-1 (Annex Q)	40021525

Features

- High peak current rating to 40 kA
- 55°C to +85°C operating temp
- RoHS Compliant and Lead-free Available
- Alternative design available with narrow 3mm wide monitor (right) lead
- Alternative design available with 2 leads only (no monitor lead)

Absolute Maximum Ratings

• For ratings of individual members of a series, see Device Ratings and Specifications chart

Continuous	TMOV34S Varistor Series	Units
Steady State Applied Voltage:		
AC Voltage Range ($V_{M(A)CRMS}$)	115 to 750	V
Transients:		
Peak Pulse Current (I_{TM})		
For 8/20 μ s Current Wave, single pulse	up to 40,000	A
Single Pulse Energy Range		
For 2ms Current Wave	280 to 1200	J
Operating Ambient Temperature Range (T_A)	-55 to + 85	°C
Storage Temperature Range (T_{STG})	-55 to + 125	°C
Temperature Coefficient (α^V) of Clamping Voltage (V_C) at Specified Test Current	<0.01	%/°C
Hi-Pot Encapsulation (Isolation Voltage Capability)	2500	V
COATING Insulation Resistance	1000	M Ω

* Contact your Littelfuse product representative to discuss alternatives and for additional information.

CAUTION: Stresses above those listed in "Absolute Maximum Ratings" may cause permanent damage to the device. This is a stress only rating and operation of the device at these or any other conditions above those indicated in the operational sections of this specification is not implied.

Applications

- SPD Products
- AC Panel Protection Modules
- UPS (Uninterruptable Power Supply)
- Inverters
- AC/DC Power Supplies

Additional Information



Datasheet



Resources



Samples

TMOV[®]34S Series Ratings & Specifications - Standard 3 Lead Design

Lead-free and RoHS Compliant Models		Maximum Rating (85°C)					Specifications (25°C)			
		Continuous		Transient			Varistor Voltage at 1mA Test Current	Maximum Clamping Volt V _C at 200A Current (8/20μs)	Typical Capacitance f = 1MHz	
		AC Volts	DC Volts	MCOV Surge Arrester	Energy 2ms	Peak Current 8 x 20μs				
Part Number	Branding	V _{MIACRMS} (V)	V _{MIDC} (V)	V _{MIACRMS} (V)	W _{TM} 1 x Pulse (J)	I _{TM} 1 x Pulse (A)	V _{NIDC} Min (V)	V _{NIDC} Max (V)	V _C (V)	C (pF)
TMOV34S111MP	TMOV34S111MP	115	150	98	280	40000	162	198	305	11500
TMOV34S131MP	TMOV34S131MP	130	175	111	310	40000	184.5	225.5	345	10000
TMOV34S141MP	TMOV34S141MP	140	188	119	340	40000	198	242	375	9000
TMOV34S151MP	TMOV34S151MP	150	200	128	360	40000	216	264	405	8000
TMOV34S181MP	TMOV34S181MP	180	240	153	400	40000	256	312	488	6800
TMOV34S201MP	TMOV34S201MP	200	265	170	430	40000	288	352	540	6500
TMOV34S251MP	TMOV34S251MP	250	330	213	490	40000	351	429	650	5000
TMOV34S271MP	TMOV34S271MP	275	369	234	550	40000	387	473	730	4500
TMOV34S301MP	TMOV34S301MP	300	400	255	590	40000	423	517	780	4050
TMOV34S321MP	TMOV34S321MP	320	420	272	640	40000	459	561	830	3800
TMOV34S331MP	TMOV34S331MP	330	435	281	650	40000	476	581	855	3700
TMOV34S351MP	TMOV34S351MP	350	460	298	700	40000	504	616	910	3500
TMOV34S391MP	TMOV34S391MP	385	506	327	800	40000	558	682	1005	3300
TMOV34S421MP	TMOV34S421MP	420	560	357	910	40000	612	748	1130	3000
TMOV34S461MP	TMOV34S461MP	460	610	391	960	40000	643.5	786.5	1188	2800
TMOV34S481MP	TMOV34S481MP	480	640	408	960	40000	675	825	1240	2700
TMOV34S511MP	TMOV34S511MP	510	675	434	960	40000	738	902	1350	2500
TMOV34S551MP	TMOV34S551MP	550	700	468	965	40000	770	939	1415	2250
TMOV34S571MP	TMOV34S571MP	575	730	489	990	40000	819	1001	1480	2200
TMOV34S621MP	TMOV34S621MP	620	800	527	1010	40000	900	1100	1589	2100
TMOV34S661MP	TMOV34S661MP	660	850	561	1030	40000	945	1155	1720	2000
TMOV34S681MP	TMOV34S681MP	680	890	578	1100	40000	980	1195	1772	1970
TMOV34S751MP	TMOV34S751MP	750	970	638	1200	40000	1080	1320	2000	1800

Notes :
 Same ratings and specifications apply to 2 leaded alternative design. Replace 'M' with 'E' in part number. Refer to Part Numbering System at the end of this document.

Ratings & Specifications - Alternative 2 Lead Design

Lead-free and RoHS Compliant Models		Maximum Rating (85°C)					Specifications (25°C)			
		Continuous		Transient			Varistor Voltage at 1mA Test Current	Maximum Clamping Volt V_C at 200A Current (8/20 μ s)	Typical Capacitance $f = 1$ MHz	
		AC Volts	DC Volts	MCOV Surge Arrester	Energy 2ms	Peak Current 8 x 20 μ s				
Part Number	Branding	$V_{M(AC)RMS}$	$V_{M(AC)}$	$V_{M(AC)RMS}$	W_{TM} 1 x Pulse	I_{TM} 1 x Pulse	$V_{N(DC) Min}$	$V_{N(DC) Max}$	V_C	C
		(V)		(V)	(J)	(A)	(V)	(V)	(V)	(pF)
TMOV34S111EP	TMOV34S111EP	115	150	98	280	40000	162	198	305	11500
TMOV34S131EP	TMOV34S131EP	130	175	111	310	40000	184.5	225.5	345	10000
TMOV34S141EP	TMOV34S141EP	140	188	119	340	40000	198	242	375	9000
TMOV34S151EP	TMOV34S151EP	150	200	128	360	40000	216	264	405	8000
TMOV34S181EP	TMOV34S181EP	180	240	153	400	40000	256	312	488	6800
TMOV34S201EP	TMOV34S201EP	200	265	170	430	40000	288	352	540	6500
TMOV34S251EP	TMOV34S251EP	250	330	213	490	40000	351	429	650	5000
TMOV34S271EP	TMOV34S271EP	275	369	234	550	40000	387	473	730	4500
TMOV34S301EP	TMOV34S301EP	300	400	255	590	40000	423	517	780	4050
TMOV34S321EP	TMOV34S321EP	320	420	272	640	40000	459	561	830	3800
TMOV34S331EP	TMOV34S331EP	330	435	281	650	40000	476	581	855	3700
TMOV34S351EP	TMOV34S351EP	350	460	298	700	40000	504	616	910	3500
TMOV34S391EP	TMOV34S391EP	385	506	327	800	40000	558	682	1005	3300
TMOV34S421EP	TMOV34S421EP	420	560	357	910	40000	612	748	1130	3000
TMOV34S461EP	TMOV34S461EP	460	610	391	960	40000	643.5	786.5	1188	2800
TMOV34S481EP	TMOV34S481EP	480	640	408	960	40000	675	825	1240	2700
TMOV34S511EP	TMOV34S511EP	510	675	434	960	40000	738	902	1350	2500
TMOV34S551EP	TMOV34S551EP	550	700	468	965	40000	770	939	1415	2250
TMOV34S571EP	TMOV34S571EP	575	730	489	990	40000	819	1001	1480	2200
TMOV34S621EP	TMOV34S621EP	620	800	527	1010	40000	900	1100	1589	2100
TMOV34S661EP	TMOV34S661EP	660	850	561	1030	40000	945	1155	1720	2000
TMOV34S681EP	TMOV34S681EP	680	890	578	1100	40000	980	1195	1772	1970
TMOV34S751EP	TMOV34S751EP	750	970	638	1200	40000	1080	1320	2000	1800

Notes :
Same ratings and specifications apply to 3 leaded design. Replace 'E' with 'M' in part number. Refer to Part Numbering System at the end of this document.

Typical time to open circuit under UL1449 Abnormal Overvoltage Limited Current Test

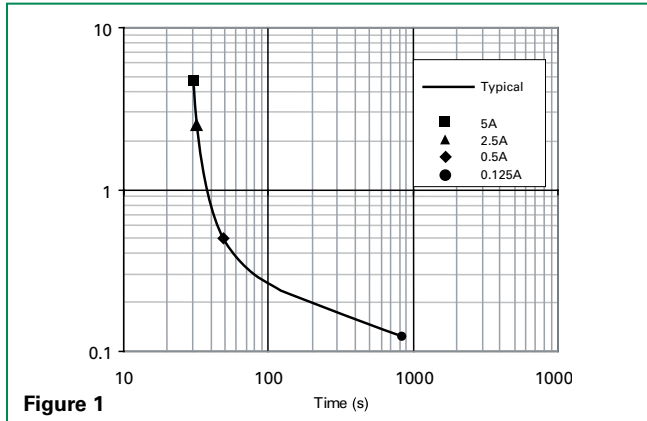

Figure 1

Note: The Industrial TMOV[®]34S varistor are intended, in conjunction with appropriate enclosure design, to help facilitate SPD module compliance to UL 1449 (Abnormal Overvoltage Limited Current Requirements). Under these extreme abnormal overvoltage conditions, the units will exhibit substantial heating and potential venting prior to opening. Modules should be designed to contain this possibility. Application testing is strongly recommended.

Peak Current & Energy Derating Curve

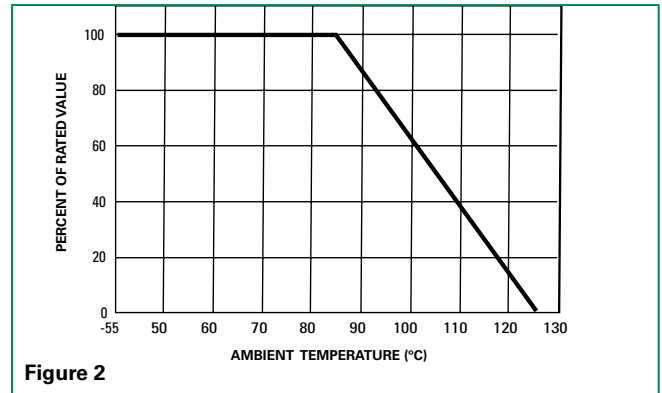

Figure 2

For applications exceeding 85°C ambient temperature, the peak surge current and energy ratings must be reduced as shown.

Pulse Rating Curve

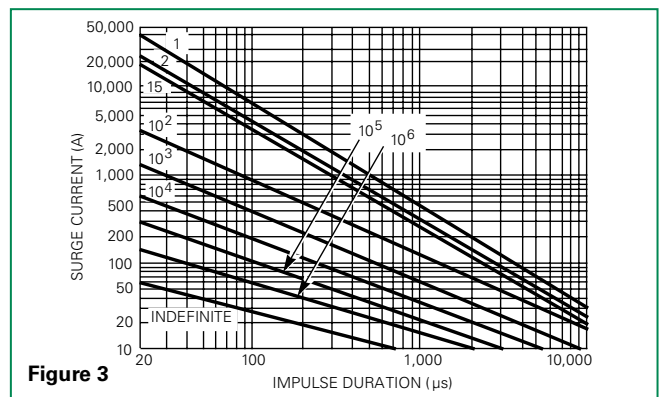

Figure 3

V-I Characteristic Curves

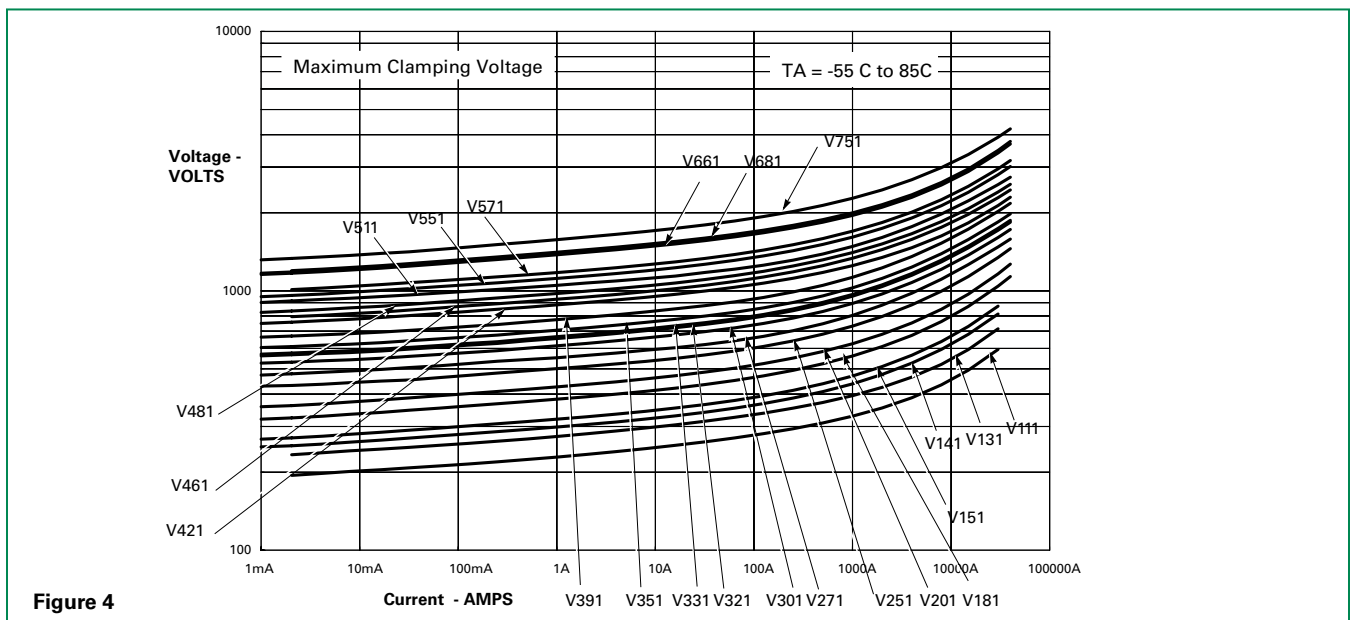
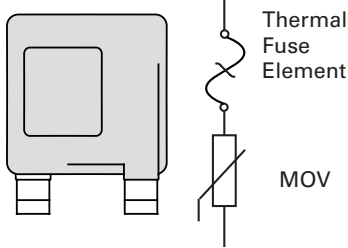

Figure 4

Lead Configurations

TMOV[®]34S Varistor "E" 2-Lead Varistor



Note: MOVs are non-polarized passive elements

TMOV[®]34S Varistor "M" 3-Lead Varistor

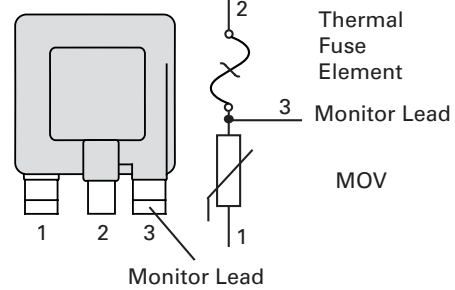

TMOV[®]34S Varistor Application Examples

The application examples below show how the monitor lead on the TMOV[®]34S varistor can be used to indicate that the thermal element has been opened. This signifies that the circuit is no longer protected from transients by the MOV.

Application Example 1

In this case, the LED is normally on, and is off when the thermal element opens.

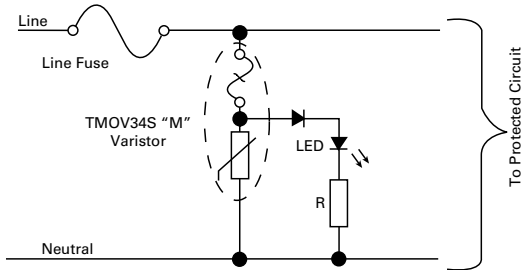

Application Example 2

This circuit utilizes an optocoupler to provide galvanic isolations between the TMOV[®]34S varistor and the indicating or alarm circuitry.

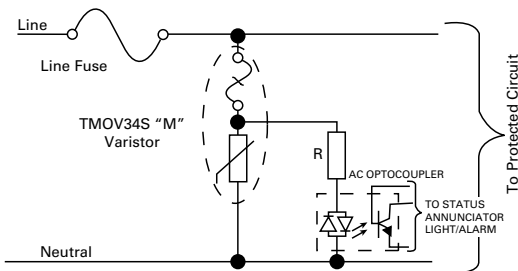

Application Example 3

This circuit illustrates the use of the monitoring lead of the TMOV[®]34S varistor to ensure that equipment is only operated when overvoltage protection is present. In normal operation the load switch relay solenoid is powered via the monitor lead of the TMOV[®]34S varistor. In the event of the thermal element being activated, the relay will de-activate, cutting power to the protected circuit and the fault LED will illuminate.

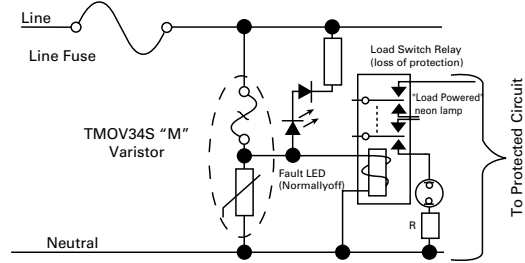

Please note: Indicator circuits are provided as a guideline only. Verification of actual indicator circuitry is the responsibility of the end user. Component values selected must be appropriate for the specific AC line voltage service and application.

Wave Solder Profile

Because the TMOV[®]34S Series varistors contain a thermal protection device, care must be taken when soldering the devices into place. Two soldering methods are possible. Firstly, hand soldering:

It is recommended to heat-sink the leads of the device. Secondly, wave-soldering: It is critically important that all preheat stage and the solder bath temperatures are rigidly controlled.

Non Lead-free Profile

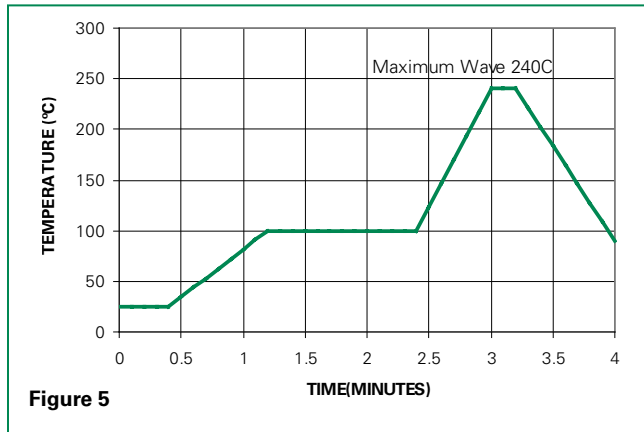

Lead-free Profile

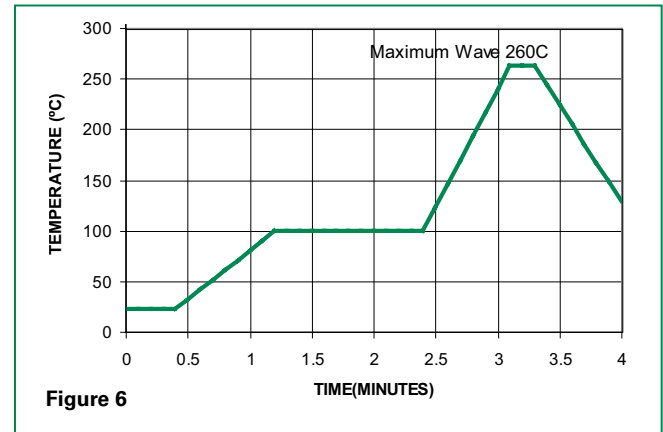

Physical Specifications

Lead Material	Tin-plated Copper
Soldering Characteristics	Solderability per MIL-STD-202, Method 208
Insulating Material	Cured, flame retardant epoxy polymer meets UL94V-0 requirements.
Device Labeling	Marked with LF, part identifier, and date code

Environmental Specifications

Operating/Storage Temperature	-55°C to +85°C/ -55°C to +125°C
Humidity Aging	+85°C, 85% RH, 1000 hours +/-10% voltage
Thermal Shock	+85°C to -40°C 5 times +/-10% voltage
Solvent Resistance	MIL-STD-202, Method 215
Moisture Sensitivity	Level 1, J-STD-020

Part Numbering System

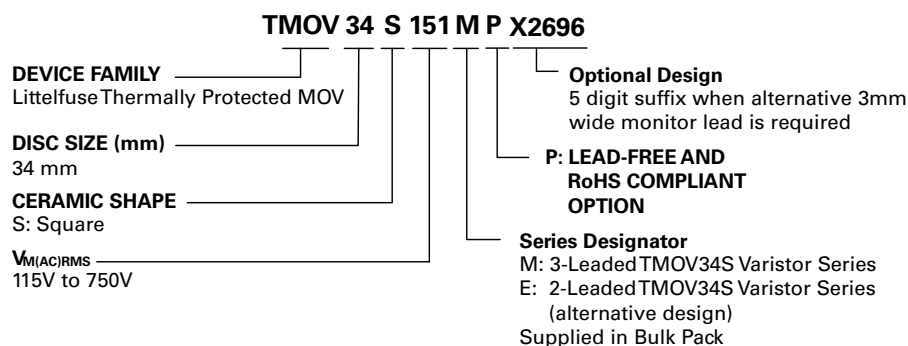

Dimensions 3 Ledged Series

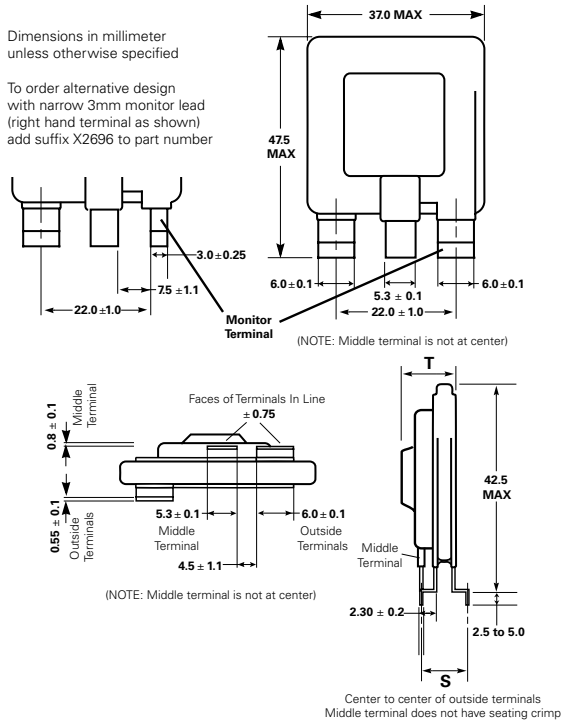

Part Number	"T" Max Body Thickness	"S" Mounting Terminal Offset
TMOV34S111M(P)	11.90	5.2 -/+ .65
TMOV34S131M(P)	12.20	5.5 -/+ .65
TMOV34S141M(P)	12.30	5.7 -/+ 0.85
TMOV34S151M(P)	12.40	5.9 -/+ 0.85
TMOV34S181M(P)	12.80	6.3 -/+ 0.85
TMOV34S201M(P)	13.00	6.5 -/+ 0.85
TMOV34S251M(P)	12.75	6.25 -/+ 0.85
TMOV34S271M(P)	12.95	6.5 -/+ 0.85
TMOV34S301M(P)	13.30	6.8 -/+ 1.0
TMOV34S321M(P)	13.50	6.9 -/+ 1.0
TMOV34S331M(P)	13.60	7.2 -/+ 1.0
TMOV34S351M(P)	13.80	7.4 -/+ 1.0
TMOV34S391M(P)	14.20	7.6 -/+ 1.0
TMOV34S421M(P)	14.50	7.85 -/+ 1.0
TMOV34S461M(P)	14.75	8.15 -/+ 1.0
TMOV34S481M(P)	14.95	8.25 -/+ 1.0
TMOV34S511M(P)	15.40	8.6 -/+ 1.0
TMOV34S551M(P)	15.60	8.65 -/+ 1.0
TMOV34S571M(P)	15.90	8.85 -/+ 1.0
TMOV34S621M(P)	16.40	9.25 -/+ 1.0
TMOV34S661M(P)	16.85	9.65 -/+ 1.0
TMOV34S681M(P)	17.20	9.85 -/+ 1.0
TMOV34S751M(P)	17.80	10.65 -/+ 1.0

Dimensions - Alternative 2 Ledged Series

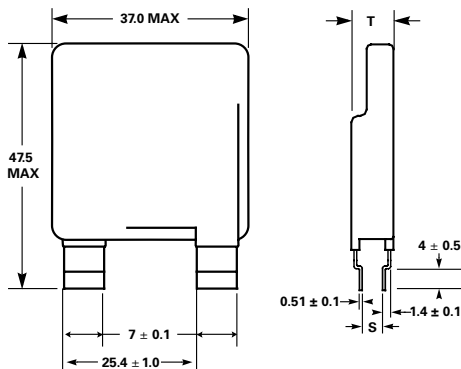

Part Number	T Dimension Max Body Thickness	S Dimension -- Mounting Terminal Offset
TMOV34S111EP	11.9	2.8 -/+ .65
TMOV34S131EP	12.2	2.9 -/+ .65
TMOV34S141EP	12.3	3.0 -/+0.85
TMOV34S151EP	12.4	3.1 -/+0.85
TMOV34S181EP	12.8	3.4 -/+0.85
TMOV34S201EP	13.0	3.6 -/+0.85
TMOV34S251EP	12.8	4.0 -/+0.85
TMOV34S271EP	13.0	4.3 -/+0.85
TMOV34S301EP	13.3	4.5 -/+1.0
TMOV34S321EP	13.5	4.7 -/+1.0
TMOV34S331EP	13.6	4.8 -/+1.0
TMOV34S351EP	13.8	5.0 -/+1.0
TMOV34S391EP	14.2	5.4 -/+1.0
TMOV34S421EP	14.5	5.7 -/+1.0
TMOV34S461EP	14.8	5.9 -/+1.0
TMOV34S481EP	15.0	6.1 -/+1.0
TMOV34S511EP	15.4	6.6 -/+1.0
TMOV34S551EP	15.6	6.8 -/+1.0
TMOV34S571EP	15.9	7.1 -/+1.0
TMOV34S621EP	16.4	7.5 -/+1.0
TMOV34S661EP	16.9	7.9 -/+1.0
TMOV34S681EP	17.2	8.2 -/+1.0
TMOV34S751EP	17.8	8.8 -/+1.0

SMOV25S[®] Varistor Series

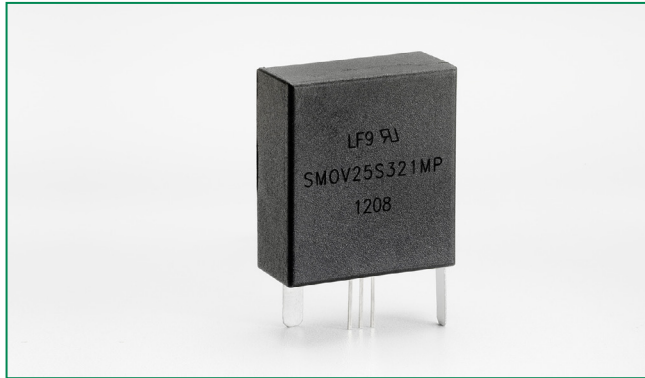

Agency Approvals

Agency	Agency Approval	Agency File Number
	UL1449	E320116

Additional Information



Datasheet



Resources



Samples

Description

The Littelfuse SMOV[®]25S thermally protected varistor is a self-protected device. It consists of a 25mm square varistor with an integral thermal disconnect designed to open in the event of overheating due to abnormal overvoltage as outlined in UL1449. The SMOV[®] helps facilitate SPD module compliance to UL1449 and offers quick thermal response due to the close proximity of the integrated thermal element to the MOV body. This configuration also offers lower inductance than most discreet solutions resulting in improved clamping performance to fast over voltage transients.

The device has a separate micro-switch, which can be used to indicate that the MOV has been disconnected from the circuit. This separate switch makes the monitoring circuitry completely isolated from the main power which ensures indicator circuit safety and simplifies the customers circuit design.

Features

- Maximum single surge capability 20 kA, 8/20 waveshape.
- Nominal Discharge Current Value: 10kA.
- Intermediate current rating: 50A/150A.
- -45°C to +75°C operating temperature.
- Recognized to UL 1449.
- Lead-Free and RoHS compliant.
- Integrated micro-switch for indication circuitry/design.

Applications

- SPD applications
- AC/DC distribution
- IT/Data center
- Power supplier
- Telecommunication

Absolute Maximum Ratings

• For ratings of individual members of a series, see Device Ratings and Specifications chart.

	SMOV25S Varistor Series	Units
Continuous:		
Steady State Applied Voltage:		
DC Voltage Range (VM(DC))	150 to 970	V
AC Voltage Range (V _{M(AC)RMS})	115 to 750	V
Transient:		
Non-Repetitive Surge Current, 8/20µs Waveform (I _{TM})	20,000	A
Non-Repetitive Energy Capability, 2ms Waveform (W _{TM})	170 to 670	J
Operating Ambient Temperature Range (T _A)	-45 to +75	°C
Storage Temperature Range (T _{STG})	-45 to +85	°C
Hi-Pot Encapsulation (Isolation Voltage Capability)	2500	V
Isolation Voltage Capability (when the thermal disconnect opens)	1500	V
Housing Insulation Resistance	>1,000	MΩ

CAUTION: Stresses above those listed in "Absolute Maximum Ratings" may cause permanent damage to the device. This is a stress only rating and operation of the device at these or any other conditions above those indicated in the operational sections of this specification is not implied.

Device Ratings & Specifications

Part Number	Maximum Rating (75°C)					Specifications (25 °C)				
	Continuous		Transient			Varistor Voltage at 1mA Test Current		Maximum Clamping Voltage 8/20µs		Typical Capacitance f = 1MHz
	AC Volts	DC Volts	Energy 2ms	Peak Surge Current 8/20µs	Nominal Discharge Current (In)					
	$V_{M(AC)}$	$V_{M(DC)}$	W_{TM}	I_{TM} 1 x Pulse	I_n	$V_{N(DC)}$ Min	$V_{N(DC)}$ Max	V_c	I_{PK}	C
	(V)	(V)	(J)	(A)	(A)		(V)	(V)	(A)	(pF)
SMOV25S111MP	115	150	170	20000	10000	162	198	295	100	3200
SMOV25S111NP										
SMOV25S131MP	130	170	190	20000	10000	184.5	225.5	335	100	2800
SMOV25S131NP										
SMOV25S151MP	150	200	220	20000	10000	216	264	390	100	2300
SMOV25S151NP										
SMOV25S181MP	175	225	250	20000	10000	243	297	450	100	1900
SMOV25S181NP										
SMOV25S251MP	250	320	330	20000	10000	351	429	640	100	1400
SMOV25S251NP										
SMOV25S271MP	275	350	350	20000	10000	387	473	700	100	1250
SMOV25S271NP										
SMOV25S301MP	300	385	370	20000	10000	423	517	765	100	1150
SMOV25S301NP										
SMOV25S321MP	320	420	390	20000	10000	459	561	825	100	1080
SMOV25S321NP										
SMOV25S421MP	420	560	460	20000	10000	612	748	1100	100	820
SMOV25S421NP										
SMOV25S461MP	460	615	490	20000	10000	675	825	1220	100	750
SMOV25S461NP										
SMOV25S511MP	510	670	520	20000	10000	738	902	1335	100	680
SMOV25S511NP										
SMOV25S551MP	550	745	550	20000	10000	819	1001	1475	100	630
SMOV25S551NP										
SMOV25S621MP	620	800	600	20000	10000	900	1100	1625	100	550
SMOV25S621NP										
SMOV25S751MP	750	970	670	20000	10000	1080	1320	1950	100	460
SMOV25S751NP										

Average power dissipation of transients should not exceed 1.5 watts

Same ratings and specifications apply to Non Isolated Monitored Switch alternative design. Replace "M" with "N" in the part number. e.g.: SMOV25S111NP.

Refer to Part Number System at the end of this document.

Thermal Characteristics

Typical time to open circuit under UL 1449 Limited Current Abnormal Overvoltage Test:

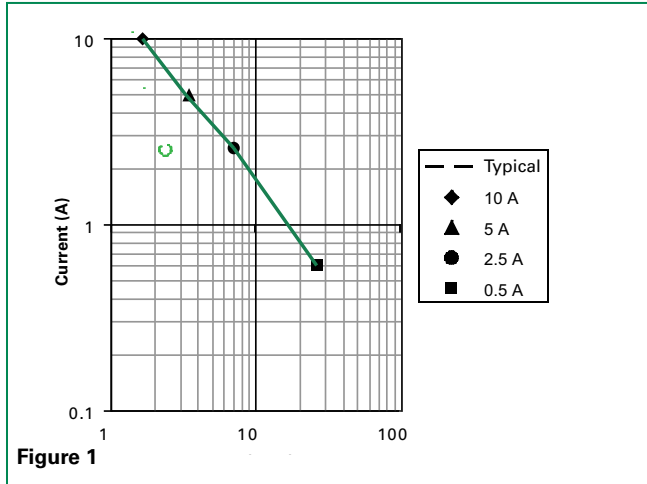

Peak Current & Energy Derating Curve

For applications exceeding 75°C ambient temperature, the peak surge current and energy ratings must be reduced as shown below.

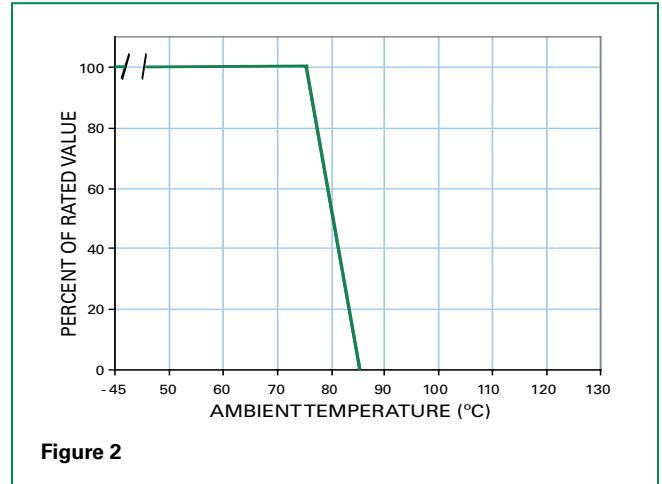

Transient V-I Characteristic Curves

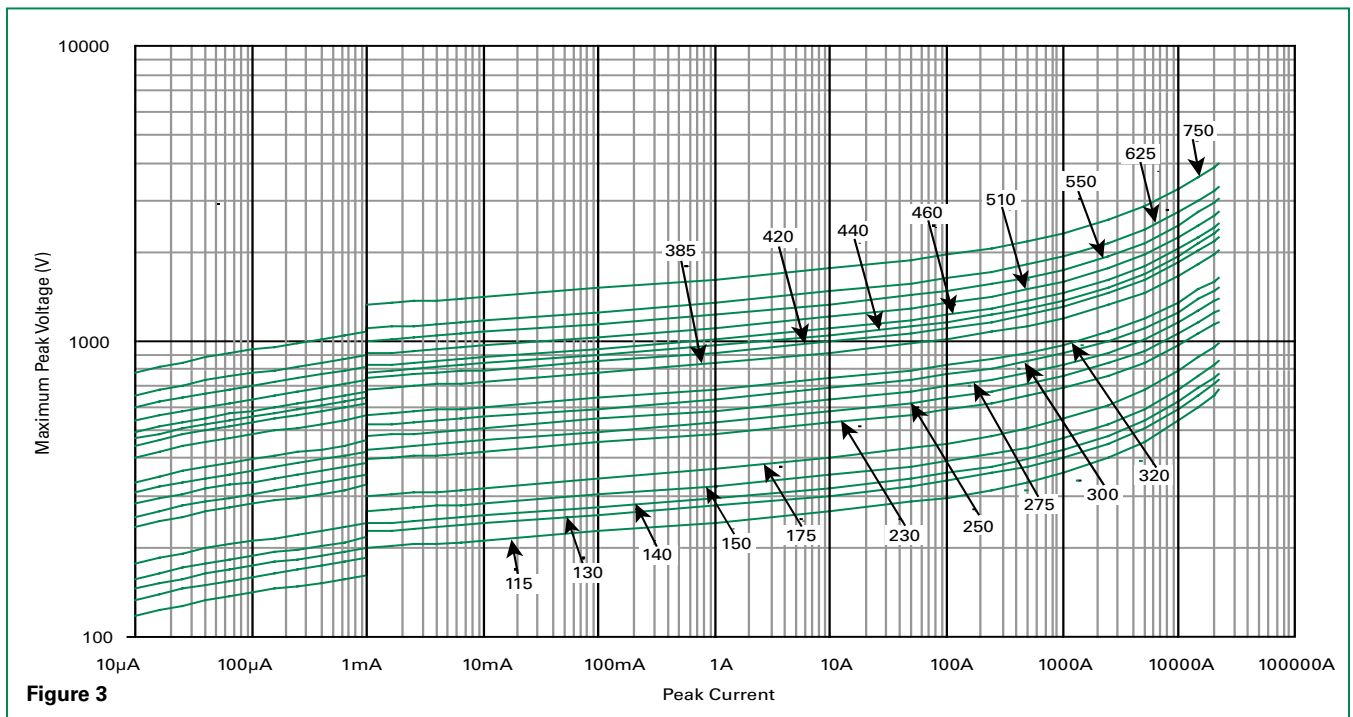

Pulse Rating Curve

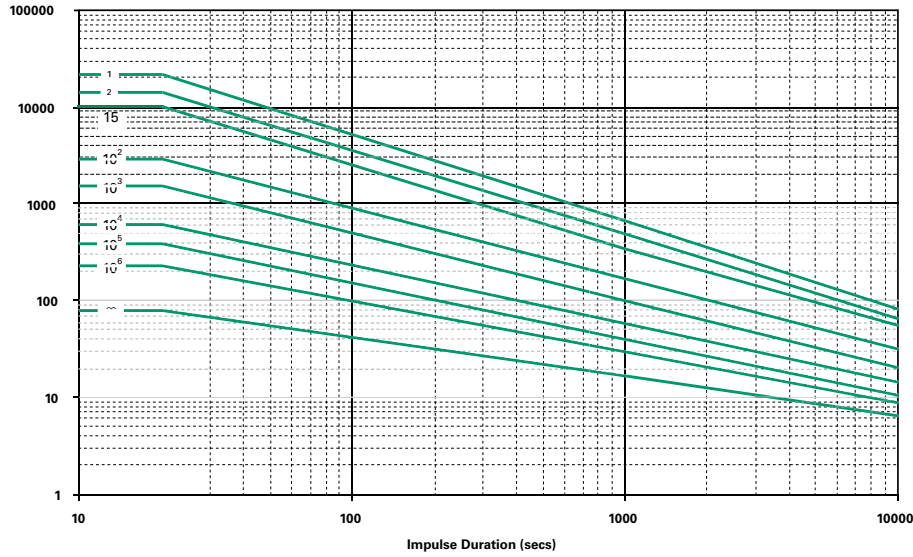

Figure 4

Wave Solder Profile

Because the SMOV®25S Varistors contain a thermal protection device, care must be taken when soldering the devices into place. Two soldering methods are possible. Firstly, hand soldering: It is

recommended to heat-sink the leads of the device. Secondly, wave-soldering: It is critically important that all preheat stage and the solder bath temperatures are rigidly controlled.

Non Lead-free Profile

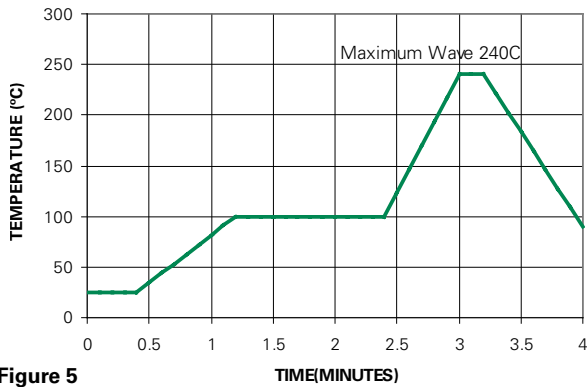

Figure 5

Lead-free Profile

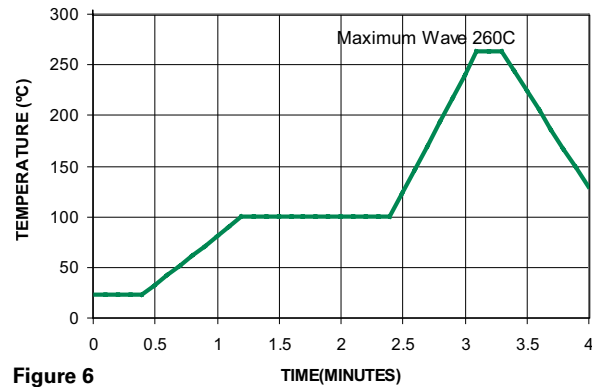

Figure 6

Physical Specifications

Lead Material	Tin-plated
Soldering Characteristics	Solderability per MIL-STD-202, Method 208
Insulating Material	Cured, flame retardant epoxy polymer meets UL94V-0 requirements
Device Labeling	Marked with LF, voltage, UL logos, and date code

Environmental Specifications

Operating/Storage Temp.	-45°C to +75°C
Passive Aging	+75°C, 1000 hours -/+10% typical voltage change
Humidity Aging	+75°C, 85%R.H., 1000 hours -/+10% typical voltage change
Thermal Shock	+75°C to -40°C 5 times -/+10% typical voltage change
Solvent Resistance	MIL-STD-202, Method 215
Moisture Sensitivity	Level 1, J-STD-020

Product Dimensions

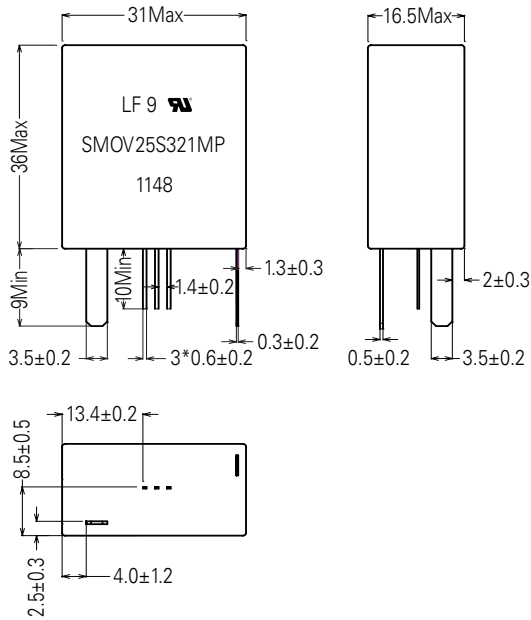

Lead Configuration

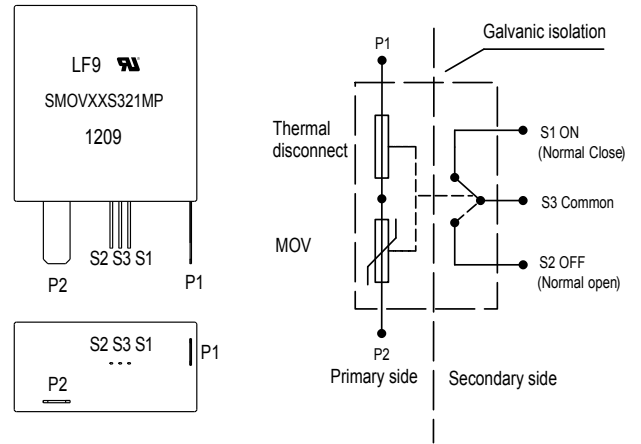

Application Example

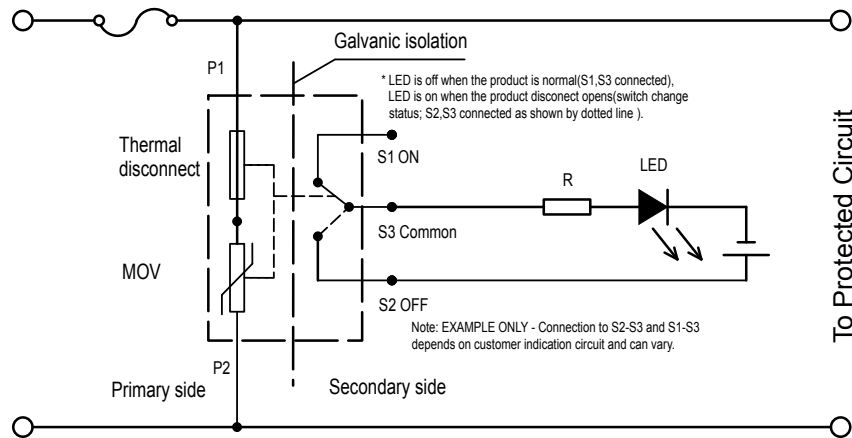

Switch Specification

SMOV Switch	Voltage DC	Current (Amps)	Contact Resistance Max.	Insulation Resistance Min.	Dielectric Strength 0.5mA/Minute
Switch	12V	0.1A	70mΩ	100MΩ	500VAC

Part Numbering System

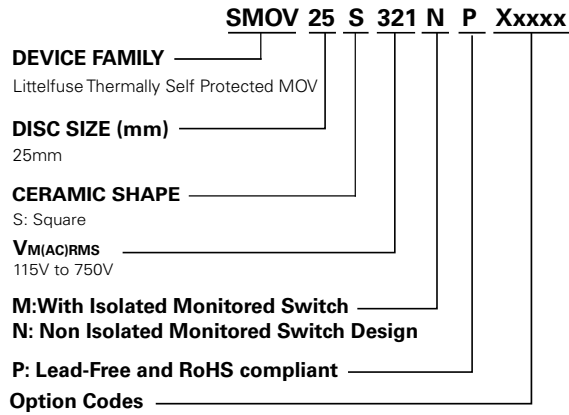

Part Marking System

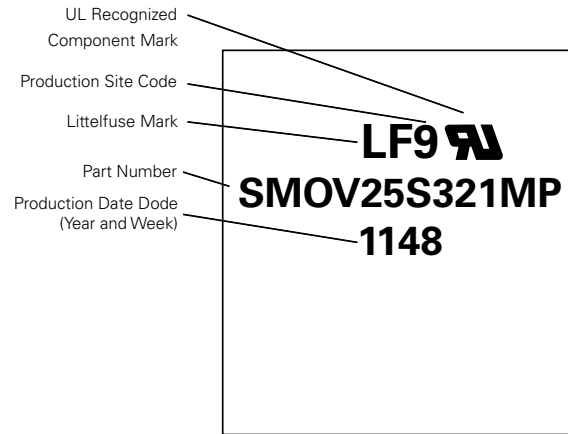

Disclaimer Notice - Information furnished is believed to be accurate and reliable. However, users should independently evaluate the suitability of and test each product selected for their own applications. Littelfuse products are not designed for, and may not be used in, all applications. Read complete Disclaimer Notice at www.littelfuse.com/disclaimer-electronics.

SMOV[®]34S Varistor Series

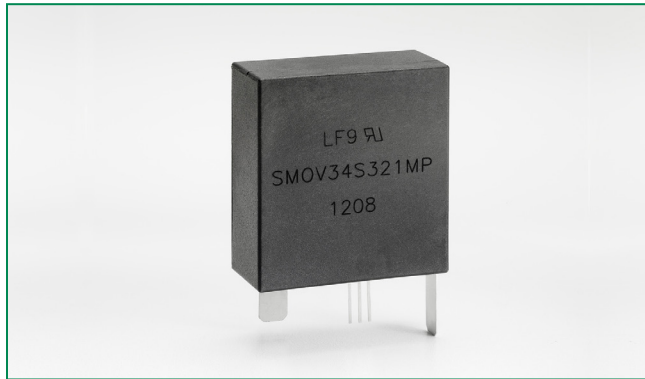

Description

The Littelfuse SMOV[®]34S thermally protected varistor is a self-protected device. It consists of a 34mm square varistor with an integral thermal disconnect designed to open in the event of overheating due to abnormal overvoltage as outlined in UL1449. The SMOV[®] helps facilitate SPD module compliance to UL1449 and offers quick thermal response due to the close proximity of the integrated thermal element to the MOV body. This configuration also offers lower inductance than most discreet solutions resulting in improved clamping performance to fast over voltage transients.

The device has a separate micro-switch, which can be used to indicate that the MOV has been disconnected from the circuit. This separate switch makes the monitoring circuitry completely isolated from the main power which ensures indicator circuit safety and simplifies the customers circuit design.

Agency Approvals

Agency	Agency Approval	Agency File Number
	UL1449	E320116

Additional Information



Datasheet



Resources



Samples

Features

- Maximum single surge capability 40 kA, 8/20 waveshape.
- Nominal Discharge Current Value: 20kA.
- Intermediate current rating: 50A/150A.
- -45°C to +75°C operating temperature.
- Recognized to UL 1449.
- Lead-Free and RoHS compliant.
- Integrated micro-switch for indication circuitry/design.

Applications

- SPD applications
- AC/DC distribution
- T/Data center
- Power supplier
- Telecommunication

Absolute Maximum Ratings

• For ratings of individual members of a series, see Device Ratings and Specifications chart

	SMOV34S S Varistor Series	Units
Continuous:		
Steady State Applied Voltage:		
DC Voltage Range (VM(DC))	150 to 970	V
AC Voltage Range (V _{M(AC)RMS})	115 to 750	V
Transient:		
Non-Repetitive Surge Current, 8/20µs Waveform (I _{TM})	40,000	A
Non-Repetitive Energy Capability, 2ms Waveform (W _{TM})	280 to 1200	J
Operating Ambient Temperature Range (T _A)	-45 to +75	°C
Storage Temperature Range (T _{STG})	-45 to +85	°C
Hi-Pot Encapsulation (Isolation Voltage Capability)	2500	V
Isolation Voltage Capability (when the thermal disconnect opens)	1500	V
Housing Insulation Resistance	>1,000	MΩ

CAUTION: Stresses above those listed in "Absolute Maximum Ratings" may cause permanent damage to the device. This is a stress only rating and operation of the device at these or any other conditions above those indicated in the operational sections of this specification is not implied.

Device Ratings & Specifications

Part Number	Maximum Rating (75°C)					Specifications (25 °C)				
	Continuous		Transient			Varistor Voltage at 1mA Test Current		Maximum Clamping Voltage 8/20µs		Typical Capacitance f = 1MHz
	AC Volts	DC Volts	Energy 2ms	Peak Surge Current 8/20µs	Nominal Discharge Current					
	$V_{M(IAC)_{RMS}}$	$V_{M(DC)}$	W_{TM}	I_{TM} 1 x Pulse	I_n	$V_{N(DC)_{Min}}$	$V_{N(DC)_{Max}}$	V_c	I_{PK}	C
(V)	(V)	(J)	(A)	(A)	(V)		(V)	(A)	(pF)	
SMOV34S111MP	115	150	280	40000	20000	162	198	305	200	11500
SMOV34S111NP										
SMOV34S131MP	130	175	310	40000	20000	184.5	225.5	345	200	10000
SMOV34S131NP										
SMOV34S151MP	150	200	360	40000	20000	216	264	405	200	8000
SMOV34S151NP										
SMOV34S181MP	180	240	400	40000	20000	256	312	488	200	6800
SMOV34S181NP										
SMOV34S251MP	250	320	490	40000	20000	351	429	650	200	5000
SMOV34S251NP										
SMOV34S271MP	275	350	550	40000	20000	387	473	730	200	4500
SMOV34S271NP										
SMOV34S301MP	300	385	590	40000	20000	432	528	780	200	4050
SMOV34S301NP										
SMOV34S321MP	320	420	640	40000	20000	459	561	830	200	3800
SMOV34S321NP										
SMOV34S421MP	420	560	910	40000	20000	612	748	1130	200	3000
SMOV34S421NP										
SMOV34S461MP	460	610	960	40000	10000	643.5	786.5	1188	200	2800
SMOV34S461NP										
SMOV34S511MP	510	675	960	40000	10000	738	902	1350	200	2500
SMOV34S511NP										
SMOV34S551MP	550	700	965	40000	10000	770	939	1415	200	2250
SMOV34S551NP										
SMOV34S621MP	620	800	1010	40000	10000	900	1100	1625	200	2100
SMOV34S621NP										
SMOV34S751MP	750	970	1200	40000	10000	1080	1320	2000	200	1800
SMOV34S751NP										

Average power dissipation of transients should not exceed 2.0 watts

Same ratings and specifications apply to Non Isolated Monitored Switch alternative design. Replace "M" with "N" in the part number. e.g.: SMOV34S111NP. Refer to Part Number System at the end of this document.

Thermal Characteristics

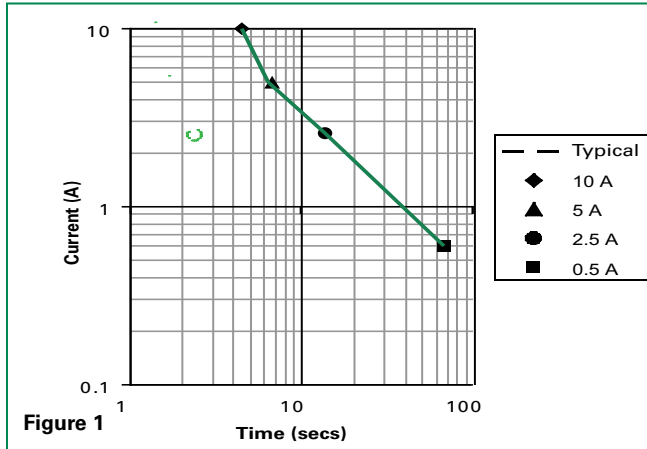

Peak Current & Energy Derating Curve

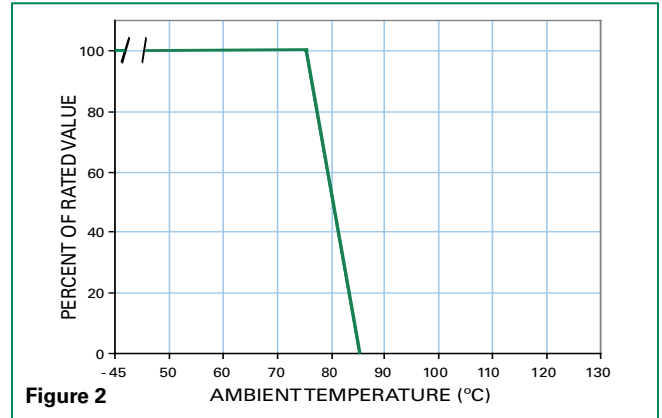

For applications exceeding 75°C ambient temperature, the peak surge current and energy ratings must be reduced as shown.

Pulse Rating Curve

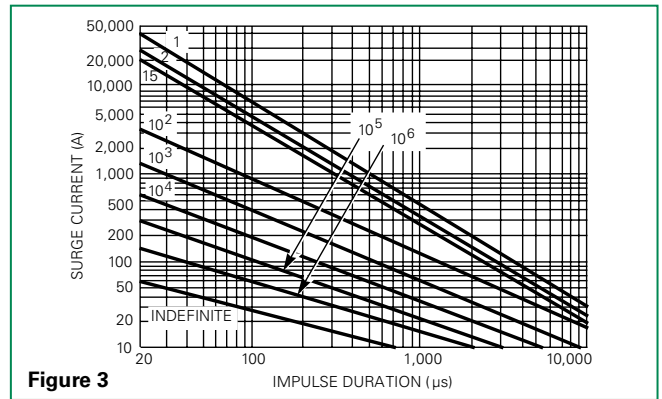

Transient V-I Characteristic Curve

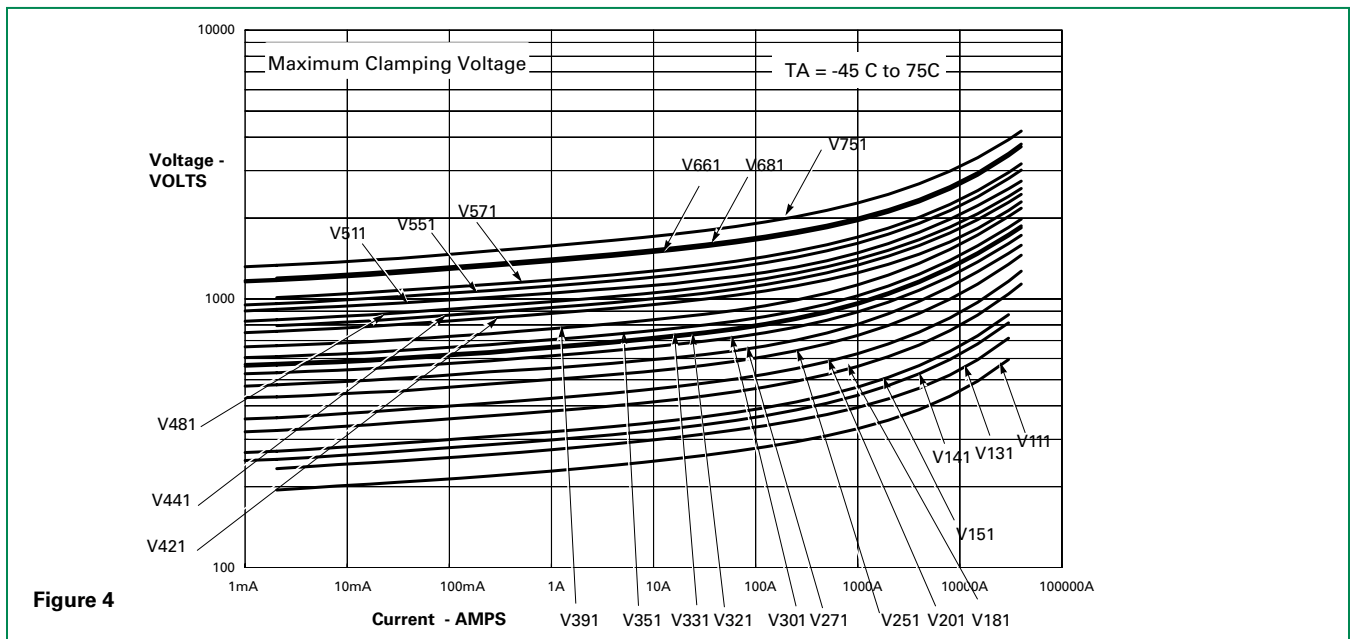

Wave Solder Profile

Because the SMOV®34S varistors contain a thermal protection device, care must be taken when soldering the devices into place. Two soldering methods are possible. Firstly, hand soldering: It is

recommended to heat-sink the leads of the device. Secondly, wave-soldering: It is critically important that all preheat stage and the solder bath temperatures are rigidly controlled.

Non Lead-free Profile

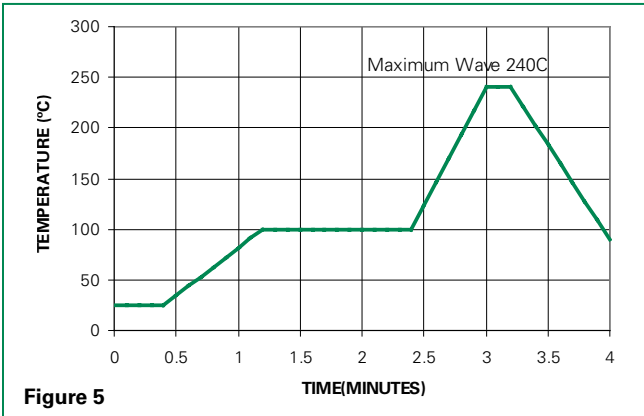

Figure 5

Lead-free Profile

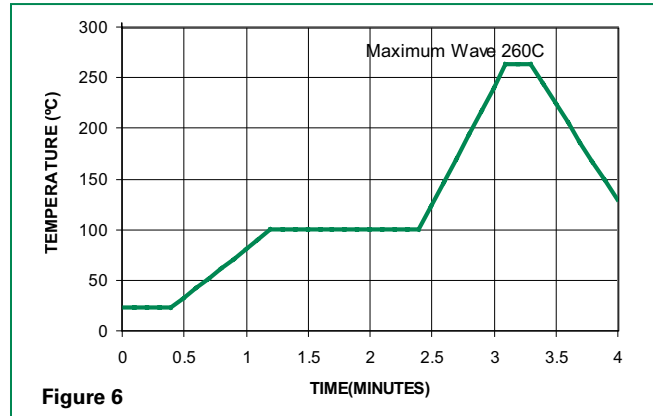

Figure 6

Physical Specifications

Lead Material	Tin-plated Copper
Soldering Characteristics	Solderability per MIL-STD-202, Method 208
Insulating Material	Cured, flame retardant epoxy polymer meets UL94V-0 requirements.
Device Labeling	Marked with LF, part identifier, and date code

Environmental Specifications

Operating/Storage Temperature	-45°C to +75°C/ -45°C to +85°C
Humidity Aging	+75°C, 85% RH, 1000 hours +/-10% voltage
Thermal Shock	+75°C to -40°C 5 times +/-10% voltage
Solvent Resistance	MIL-STD-202, Method 215
Moisture Sensitivity	Level 1, J-STD-020

Part Numbering System

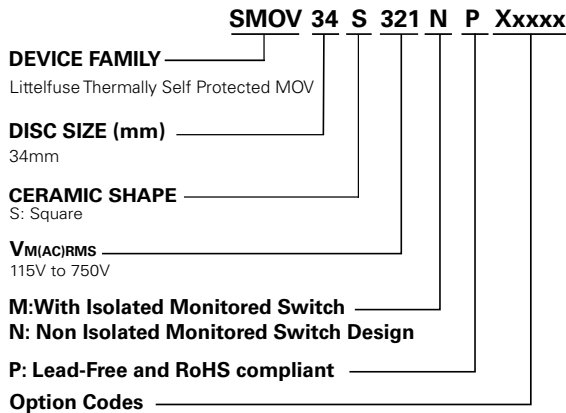

Part Marking System

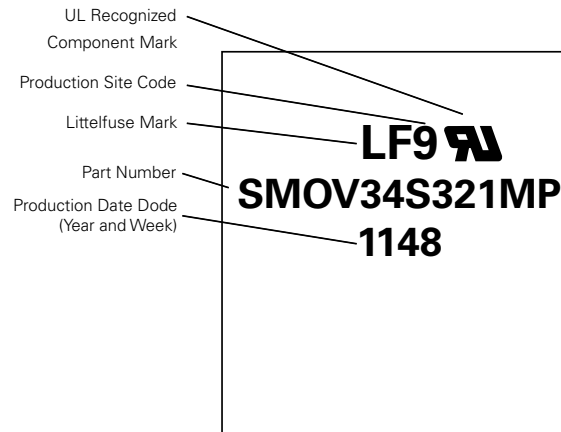

Device Dimension

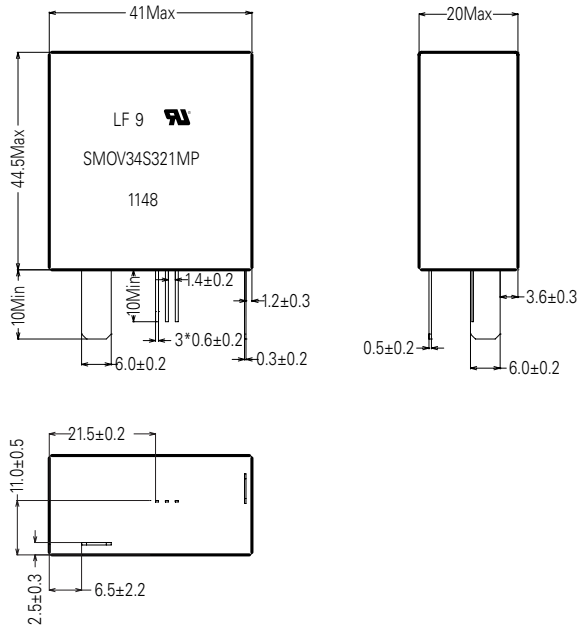

Lead Configuration

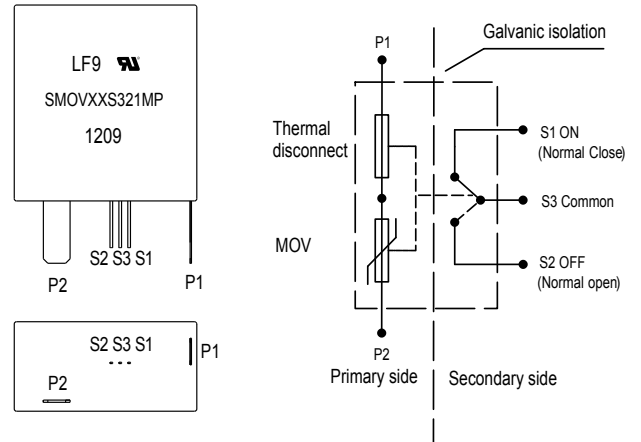

Application Example

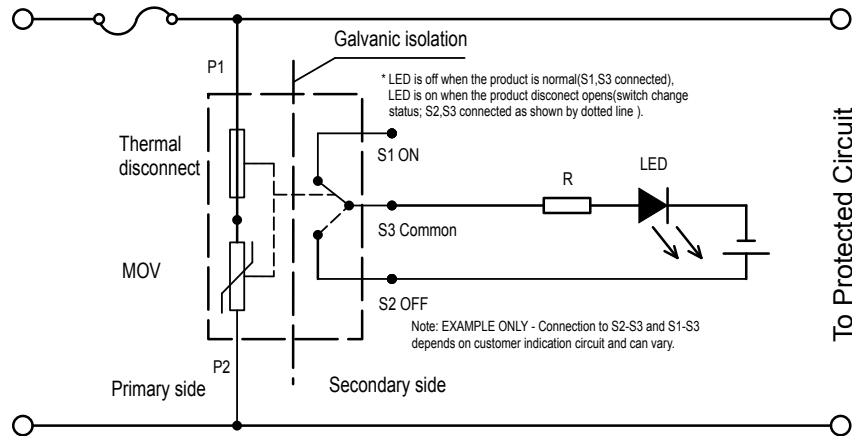

Switch Specification

SMOV Switch	Voltage DC	Current (Amps)	Contact Resistance Max.	Insulation Resistance Min.	Dielectric Strength 0.5mA/Minute
Switch	12V	0.1A	70mΩ	100MΩ	500VAC

Disclaimer Notice - Information furnished is believed to be accurate and reliable. However, users should independently evaluate the suitability of and test each product selected for their own applications. Littelfuse products are not designed for, and may not be used in, all applications. Read complete Disclaimer Notice at www.littelfuse.com/disclaimer-electronics.

FBMOV Varistor Series

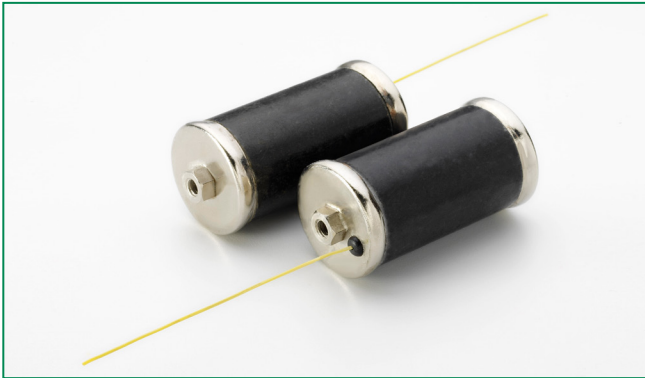

Description

The Littelfuse FBMOV Series thermally protected and non-fragmenting varistor represents a new development in circuit protection. It consists of a 40kA varistor building block (MOV) with an integral thermally activated element designed to open in the event of overheating due to abnormal over-voltage, limited current conditions.

FBMOV series devices also include a varistor series fuse which prevents the part from rupturing when subjected to high fault current (up to 200kA). The tubular fuse-like body allows for easy mechanical connection in the application.

Another feature of FBMOV is an indicator lead, which may be connected to monitoring circuitry and used to signal if the MOV has been disconnected.

FBMOV series devices offer quick thermal response due to the close proximity of the integrated fusing thermal element to the MOV body. The integrated configuration also offers lower inductance than most discreet solutions resulting in improved clamping performance to fast over-voltage transients.

Applications

- Type 1 SPD (Surge Protection Device) Products
- Power supplies
- Transformer
- Residential Service Panel
- Power distribution
- Telecommunication
- IT/Data Center

Absolute Maximum Ratings

• For ratings of individual members of a series, see Device Ratings and Specifications chart

Continuous:	FBMOV Series	Units
Steady State Applied Voltage:		
DC Voltage Range (V_{MIDC})	150 to 970	V
AC Voltage Range ($V_{M(AC)RMS}$)	115 to 750	V
Transient:		
Non-Repetitive Surge Current, 8/20 μ s Waveform (I_{TM})	40,000	A
Non-Repetitive Energy Capability, 2ms Waveform (W_{TM})	340 to 1340	J
Operating Ambient Temperature Range (T_A)	-55 to +85	°C
Storage Temperature Range (T_{STG})	-55 to +125	°C
Temperature Coefficient (α^V) of Clamping Voltage (V_C) at Specified Test Current	<0.01	%/°C
Hi-Pot Encapsulation (Isolation Voltage Capability)	2500	V
COATING Insulation Resistance	>1000	M Ω

Features

- RoHS compliant and Lead-free
- Will open circuit without rupture during UL 1449 Intermediate Current Test of 100A, 500A and 1,000A, and Short Circuit Current Test of 200,000A
- Indicator Lead for monitoring MOV

Additional Information



Datasheet



Resources



Samples

FBMOV Series Ratings & Specifications

Part Number	Maximum Rating (85°C)				Specifications (25°C)				
	Continuous		Transient		Varistor Voltage at 1mA DC Test Current			Maximum Clamping Volt V_C at 200A Current (8/20 μ s)	Typical Capacitance $f = 1$ MHz
	AC Volts	DC Volts	Energy (2ms)	Peak Current 8 x 20 μ s					
	$V_{M(AC)RMS}$	$V_{M(DC)}$	W_{TM}	I_{TM}	Min	$V_{N(DC)}$	Max	V_C	C
(V)	(V)	(J)	(A)	(V)	(V)	(V)	(V)	(pF)	
FBMOV115M	115	150	340	40000	162	180	198	295	6400
FBMOV130M	130	170	380	40000	184.5	205	225.5	335	5600
FBMOV140M	140	180	420	40000	198	220	242	355	5000
FBMOV150M	150	200	440	40000	216	240	264	390	4600
FBMOV175M	175	225	500	40000	243	270	297	450	3800
FBMOV230M	230	300	600	40000	324	360	396	585	3000
FBMOV250M	250	320	660	40000	351	390	429	640	2800
FBMOV275M	275	350	700	40000	387	430	473	700	2500
FBMOV300M	300	385	740	40000	423	470	517	765	2300
FBMOV320M	320	420	780	40000	459	510	561	825	2160
FBMOV385M	385	505	860	40000	558	620	682	1010	1800
FBMOV420M	420	560	920	40000	612	680	748	1100	1640
FBMOV440M	440	585	940	40000	643.5	715	786.5	1160	1580
FBMOV460M	460	615	980	40000	675	750	825	1220	1500
FBMOV510M	510	670	1040	40000	738	820	902	1335	1360
FBMOV550M	550	745	1100	40000	819	910	1001	1475	1260
FBMOV625M	625	825	1200	40000	900	1000	1100	1625	1110
FBMOV750M	750	970	1340	40000	1080	1200	1320	1950	920

NOTE: Average power dissipation of transients not to exceed 2.5W. See Figures 3 and 4 for more information on power dissipation.

Peak Current, Energy and Power De-rating Curve

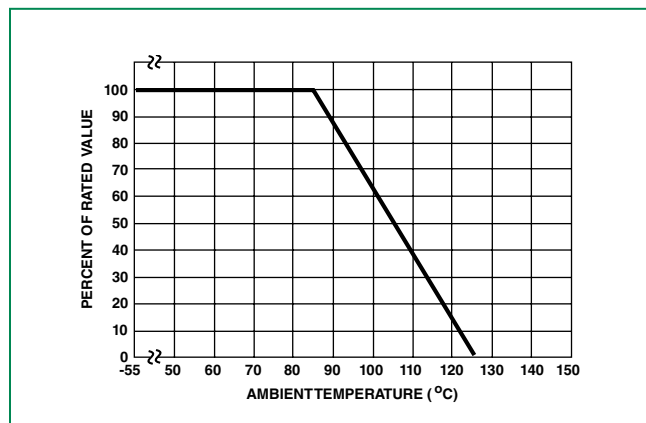

For applications exceeding 85° C, ambient temperatures, the peak surge current and energy rating must be reduced as shown in Figure 1.

Peak Pulse Current Test Waveform

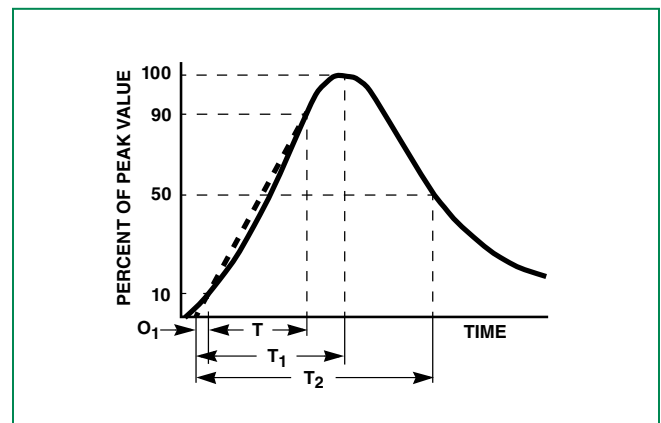

O_1 = Virtual Origin of Wave
 T = Time from 10% to 90% of Peak
 T_1 = Rise Time = $1.25 \times T$
 T_2 = Decay Time

Example - For an 8/20 μ s Current Waveform:

$8\mu s = T_1 = \text{Rise Time}$
 $20\mu s = T_2 = \text{Decay Time}$

V-I Characteristic Curves

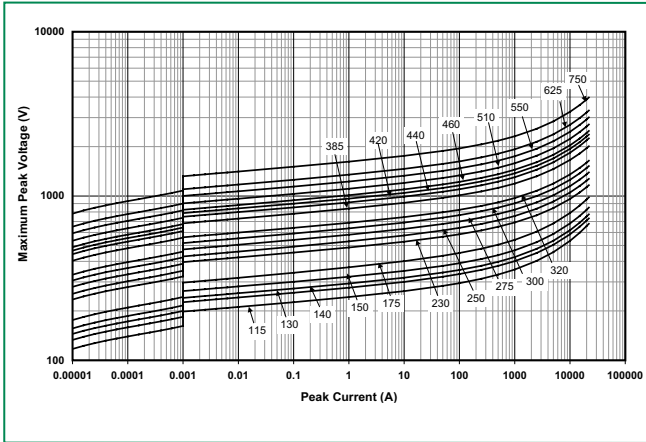

Pulse Rating Curves

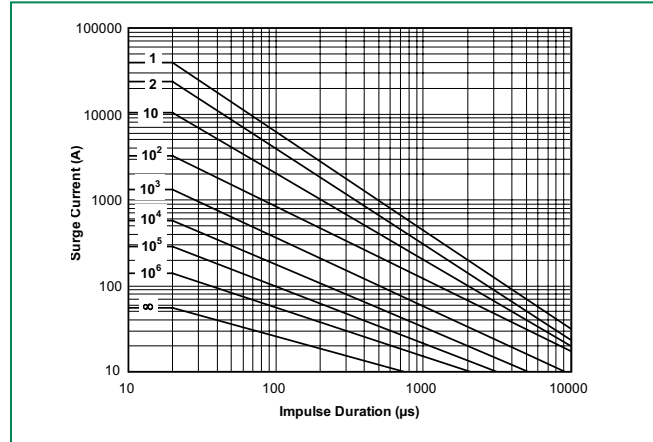

Dimensions

Typical Dimensions in Millimeters [Inches]

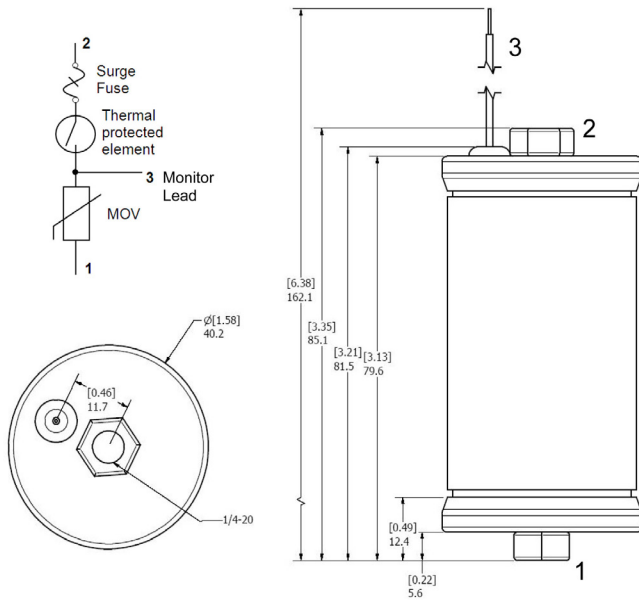

Part Numbering System

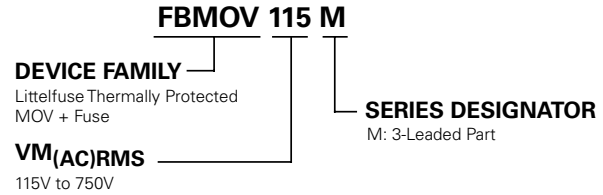

Disclaimer Notice - Information furnished is believed to be accurate and reliable. However, users should independently evaluate the suitability of and test each product selected for their own applications. Littelfuse products are not designed for, and may not be used in, all applications. Read complete Disclaimer Notice at www.littelfuse.com/disclaimer-electronics.



Expertise Applied | Answers Delivered

littelfuse.com
circuitprotection@littelfuse.com