

SURFACE MOUNT SCHOTTKY BARRIER RECTIFIER

Features

- ◆ The plastic package carries Underwriters Laboratory Flammability Classification 94V-0
- ◆ For surface mounted applications
- ◆ Metal silicon junction, majority carrier conduction
- ◆ Low power loss, high efficiency
- ◆ Built-in strain relief, ideal for automated placement
- ◆ High forward surge current capability
- ◆ High temperature soldering guaranteed:
250 °C/10 seconds at terminals

DO-214AA/SMB

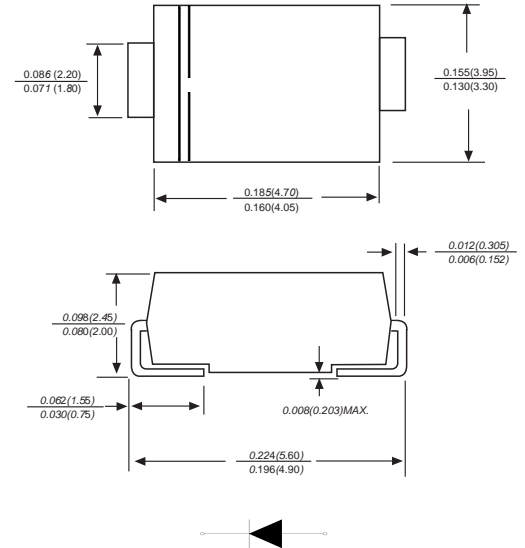

Dimensions in inches and (millimeters)

Mechanical Data

Case: JEDEC DO-214AA/SMB molded plastic body
 Terminals: Solderable per MIL-STD-750, Method 2026
 Polarity: Color band denotes cathode end Mounting
 Position: Any
 Weight: 0.003 ounce, 0.095 grams

Maximum Ratings And Electrical Characteristics

Ratings at 25°C ambient temperature unless otherwise specified.

Single phase half-wave 60Hz, resistive or inductive load, for capacitive load current derate by 20%.

Parameter	SYMBOLS	MDD SS32B	MDD SS33B	MDD SS34B	MDD SS35B	MDD SS36B	MDD SS38B	MDD SS310B	MDD SS3150B	MDD SS3200B	UNITS		
Marking Code													
Maximum repetitive peak reverse voltage	V_{RRM}	20	30	40	50	60	80	100	150	200	V		
Maximum RMS voltage	V_{RMS}	14	21	28	35	42	56	70	105	140	V		
Maximum DC blocking voltage	V_{DC}	20	30	40	50	60	80	100	150	200	V		
Maximum average forward rectified current	$I_{(AV)}$	3									A		
Peak forward surge current 8.3ms single half sine-wave superimposed on rated load (JEDEC Method)	I_{FSM}	80									A		
Maximum instantaneous forward voltage at 3.0A	V_F	0.55			0.7			0.85		0.95	V		
Maximum DC reverse current $T_A=25^\circ\text{C}$ at rated DC blocking voltage $T_A=100^\circ\text{C}$	I_R	0.5					0.3					mA	
Typical junction capacitance (NOTE 1)	C_J	450				400							pF
Typical thermal resistance (NOTE 2)	$R_{\theta JA}$	60										$^\circ\text{C}/\text{W}$	
Operating junction temperature range	T_J	-55 to +150										$^\circ\text{C}$	
Storage temperature range	T_{STG}	-55 to +150										$^\circ\text{C}$	

Note: 1. Measured at 1MHz and applied reverse voltage of 4.0V D.C.
 2. P.C.B. mounted with 2.0"x2.0" (5.0x5.0cm) copper pad areas

Typical Characteristics

Fig.1 Forward Current Derating Curve

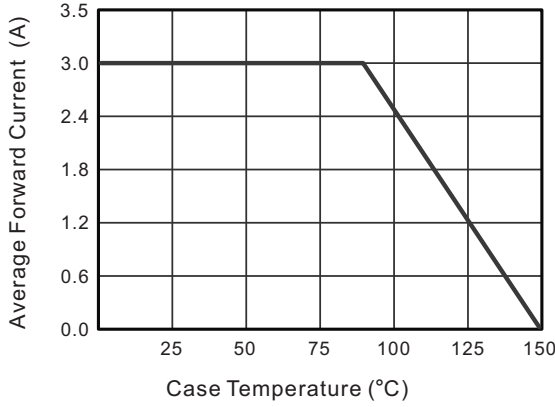

Fig.2 Typical Reverse Characteristics

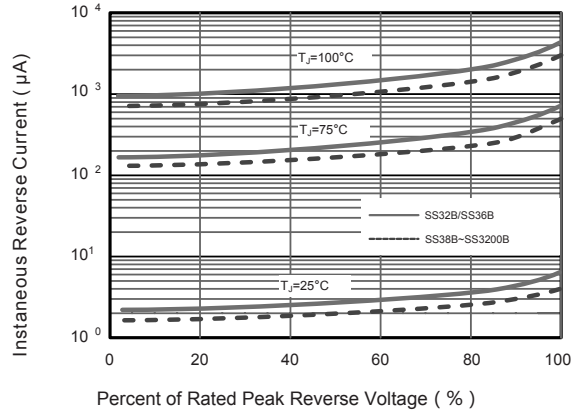

Fig.3 Typical Forward Characteristic

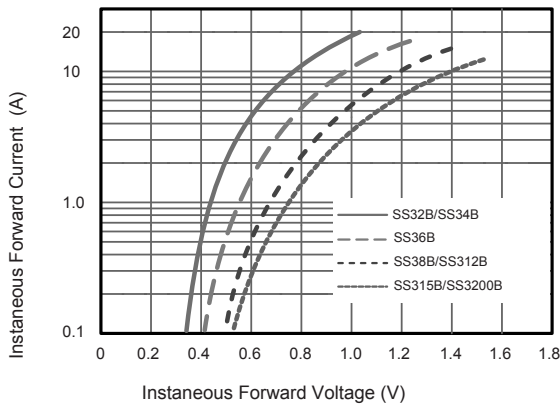

Fig.4 Typical Junction Capacitance

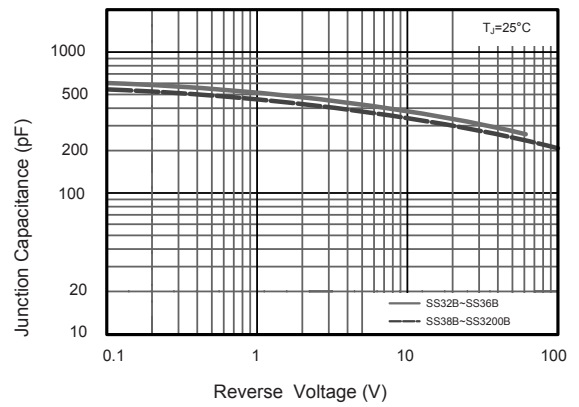

Fig.5 Maximum Non-Repetitive Peak Forward Surge Current

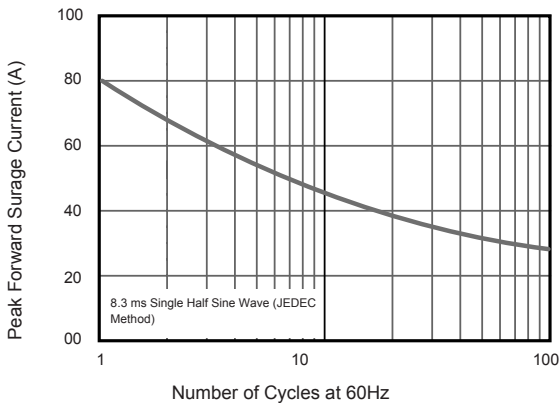
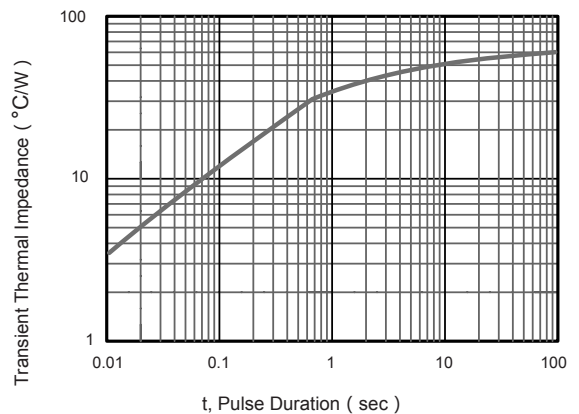
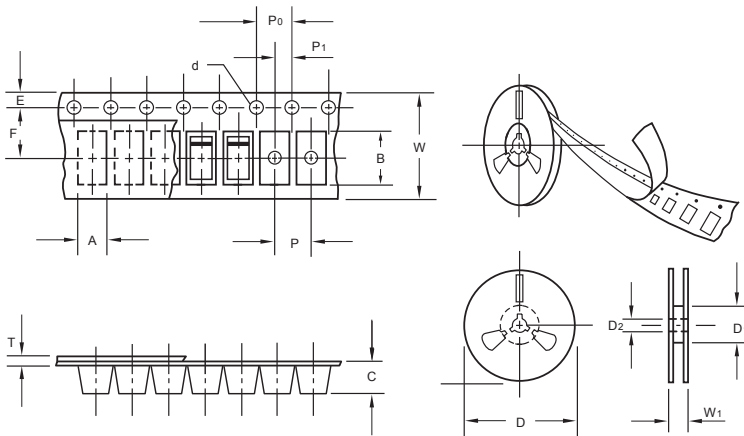

Fig.6 Typical Transient Thermal Impedance



The curve above is for reference only.

Packing information



unit:mm

Item	Symbol	Tolerance	SMB
Carrier width	A	0.1	3.81
Carrier length	B	0.1	5.41
Carrier depth	C	0.1	2.42
Sprocket hole	d	0.05	1.50
13" Reel outside diameter	D	2.0	330.00
13" Reel inner diameter	D1	min	50.00
Feed hole diameter	D2	0.5	13.00
Sprocket hole position	E	0.1	1.75
Punch hole position	F	0.1	5.55
Punch hole pitch	P	0.1	8.00
Sprocket hole pitch	P0	0.1	4.00
Embossment center	P1	0.1	2.00
Overall tape thickness	T	0.1	0.30
Tape width	W	0.3	12.00
Reel width	W1	1.0	12.30

Note: Devices are packed in accordance with EIA standard RS-481-A and specifications listed above.

Reel packing

PACKAGE	REEL SIZE	REEL (pcs)	COMPONENT SPACING (mm)	BOX (pcs)	INNER BOX (mm)	REEL DIA, (mm)	CARTON SIZE (mm)	CARTON (pcs)	APPROX. GROSS WEIGHT (kg)
SMB	13"	3,000	4.0	6,000	190*190*41	330	365*365*360	48,000	14.0

Suggested Pad Layout

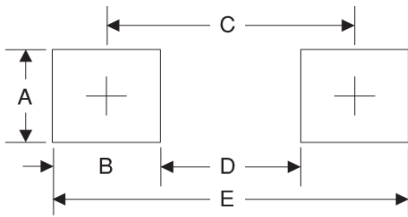

Symbol	Unit (mm)	Unit (inch)
A	2.8	0.110
B	2.4	0.094
C	4.6	0.181
D	2.2	0.086
E	7.0	0.276