

SURFACE MOUNT ULTRA FAST RECTIFIER

Features

- ◆ The plastic package carries Underwriters Laboratory Flammability Classification 94V-0
- ◆ For surface mounted applications
- ◆ Ultra fast switching for high efficiency
- ◆ Low reverse leakage
- ◆ Built-in strain relief, ideal for automated placement
- ◆ High forward surge current capability
- ◆ High temperature soldering guaranteed
250 °C/10 seconds at terminals

Mechanical Data

Case : JEDEC DO-214AC/SMA Molded plastic body

Terminals : Solder plated, solderable per MIL-STD-750, Method 2026

Polarity : Polarity symbol marking on body

Mounting Position : Any

Weight : 0.002 ounce, 0.07 grams

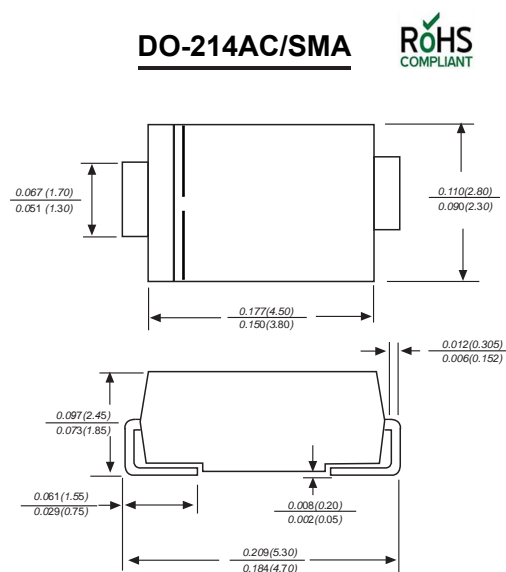

Dimensions in inches and (millimeters)

Maximum Ratings And Electrical Characteristics

Ratings at 25°C ambient temperature unless otherwise specified.

Single phase half-wave 60Hz, resistive or inductive load, for capacitive load current derate by 20%.

Parameter	SYMBOLS	MDD US1A	MDD US1B	MDD US1D	MDD US1G	MDD US1J	MDD US1K	MDD US1M	UNITS
Marking Code									
Maximum repetitive peak reverse voltage	V_{RRM}	50	100	200	400	600	800	1000	V
Maximum RMS voltage	V_{RMS}	35	70	140	280	420	560	700	V
Maximum DC blocking voltage	V_{DC}	50	100	200	400	600	800	1000	V
Maximum average forward rectified current at $T_L=125^\circ\text{C}$	$I_{(AV)}$	1.0							A
Peak forward surge current 8.3ms single half sine-wave superimposed on rated load (JEDEC Method)	I_{FSM}	30							A
Maximum instantaneous forward voltage at 1.0A	V_F	1.0		1.30		1.70			V
Maximum DC reverse current $T_A=25^\circ\text{C}$ at rated DC blocking voltage $T_A=125^\circ\text{C}$	I_R	5 100							μA
Maximum reverse recovery time (NOTE 1)	t_{rr}	50				75			ns
Typical junction capacitance (NOTE 3)	C_J	15.0							pF
Typical thermal resistance (NOTE 2)	$R_{\theta JA}$	55.0							$^\circ\text{C}/\text{W}$
	$R_{\theta JC}$	11.0							
Operating junction and storage temperature range	T_J, T_{STG}	-55 to +150							$^\circ\text{C}$

- Note:**
1. Reverse recovery condition $I_F=0.5\text{A}, I_R=1.0\text{A}, I_{rr}=0.25\text{A}$
 2. P.C.B. mounted with 2.0x2.0" (5.0x5.0cm) copper pad areas.
 3. Measured at 1MHz and applied reverse voltage of 4.0V D.C.

Ratings And Characteristic Curves

Fig.1 Forward Current Derating Curve

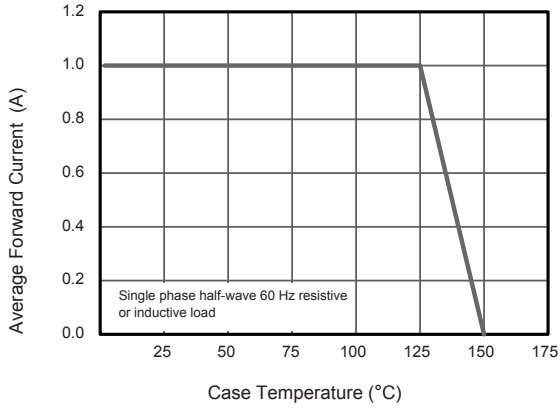

Fig.2 Typical Reverse Characteristics

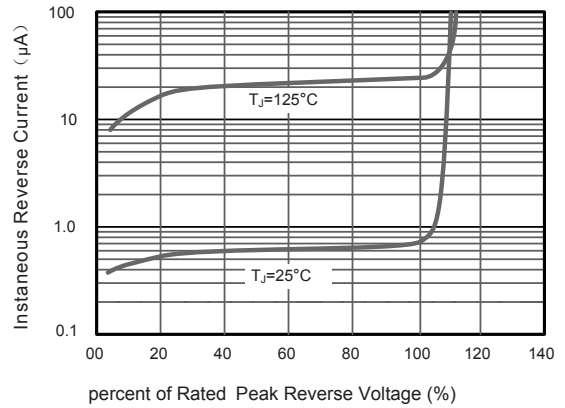

Fig.3 Typical Forward Characteristics

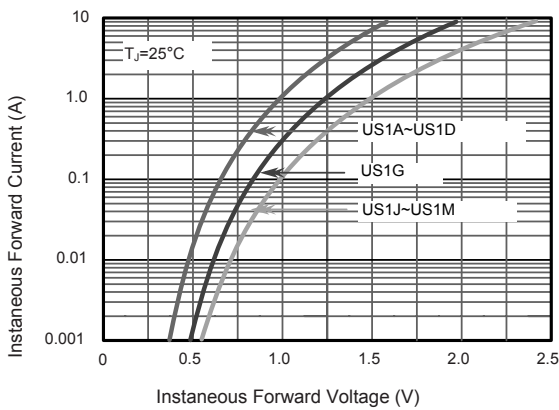

Fig.4 Maximum Non-Repetitive Peak Forward Surge Current

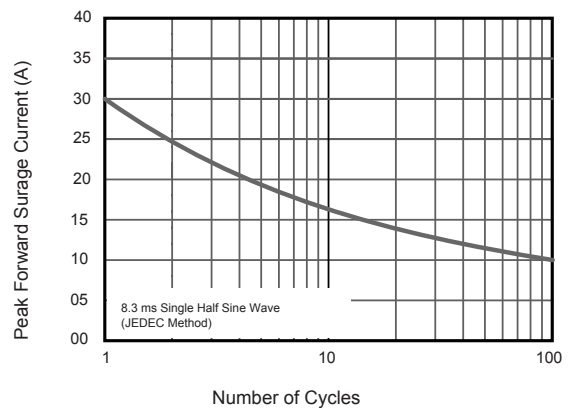

Fig.5 Typical Transient Thermal Impedance

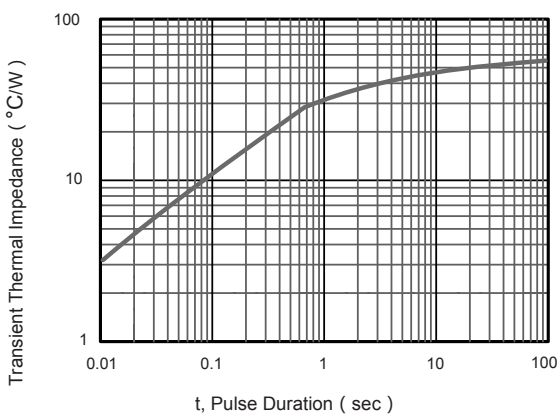
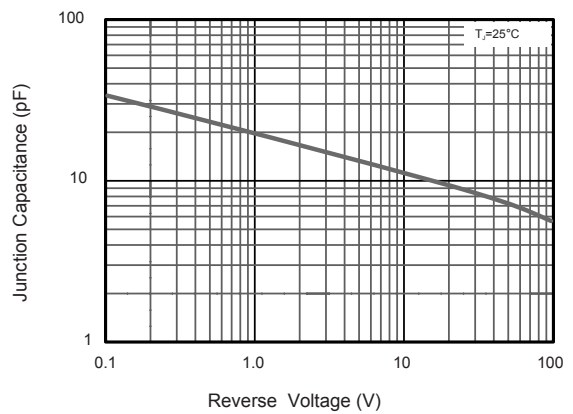
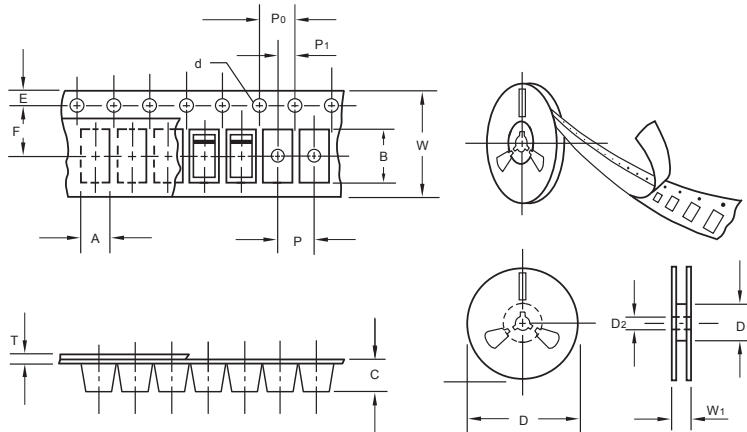

Fig.6 Typical Junction Capacitance



The curve above is for reference only.

Packing information



unit:mm

Item	Symbol	Tolerance	SMA
Carrier width	A	0.1	2.80
Carrier length	B	0.1	5.33
Carrier depth	C	0.1	2.36
Sprocket hole	d	0.05	1.50
13" Reel outside diameter	D	2.0	330.00
13" Reel inner diameter	D ₁	min	50.00
7" Reel outside diameter	D	2.0	178.00
7" Reel inner diameter	D ₁	min	62.00
Feed hole diameter	D ₂	0.5	13.00
Sprocket hole position	E	0.1	1.75
Punch hole position	F	0.1	5.50
Punch hole pitch	P	0.1	4.00
Sprocket hole pitch	P ₀	0.1	4.00
Embossment center	P ₁	0.1	2.00
Overall tape thickness	T	0.1	0.28
Tape width	W	0.3	12.00
Reel width	W ₁	1.0	18.00

Note: Devices are packed in accordance with EIA standard RS-481-A and specifications listed above.

Reel packing

PACKAGE	REEL SIZE	REEL (pcs)	COMPONENT SPACING (m/m)	BOX (pcs)	INNER BOX (m/m)	REEL DIA, (m/m)	CARTON SIZE (m/m)	CARTON (pcs)	APPROX. GROSS WEIGHT (kg)
SMA	7"	2,000	4.0	4,000	183*155*183	178	382*356*392	80,000	16.0
SMA	11"	5,000	4.0	10,000	290*290*38	330	310*310*360	80,000	11.0
SMA	13"	7,500	4.0	15,000	335*335*38	330	350*330*360	120,000	14.5

Suggested Pad Layout



Symbol	Unit (mm)	Unit (inch)
A	1.68	0.066
B	1.52	0.060
C	3.93	0.154
D	2.41	0.095
E	5.45	0.215