

SURFACE MOUNT GENERAL PURPOSE SILICON RECTIFIER

Features

- ◆ Glass passivated device
- ◆ Ideal for surface mounted applications
- ◆ Low reverse leakage
- ◆ Metallurgically bonded construction
- ◆ High temperature soldering guaranteed:
- ◆ 250°C/10 seconds, 0.375" (9.5mm) lead length, 5 lbs. (2.3kg) tension

Mechanical Data

Case : SOD-323

Terminals : Solderable per MIL-STD-750, Method 2026A

Polarity : Polarity symbol marking on body

Mounting Position : Any

Weight : 0.00619 ounce, 0.00548 grams

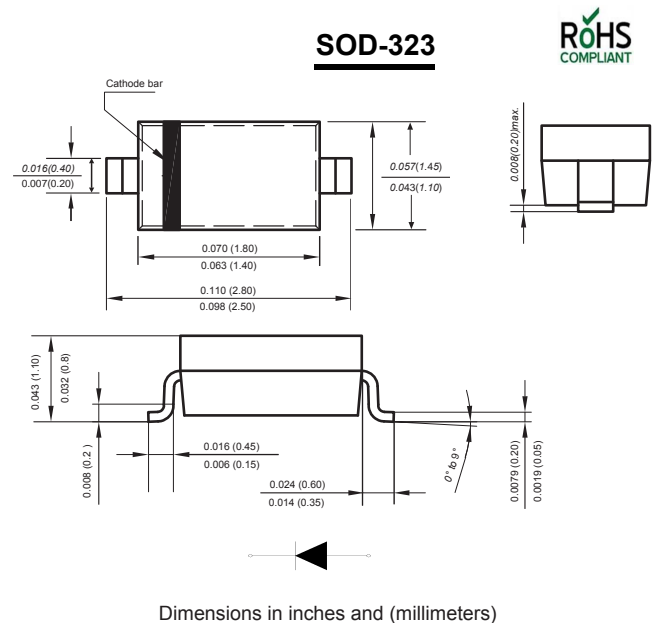

Maximum Ratings And Electrical Characteristics

Ratings at 25°C ambient temperature unless otherwise specified.

Single phase half-wave 60Hz, resistive or inductive load, for capacitive load current derate by 20%.

Parameter	SYMBOLS	1N4001WS	1N4002WS	1N4003WS	1N4004WS	1N4005WS	1N4006WS	1N4007WS	UNITS
		MDD D1	MDD D2	MDD D3	MDD D4	MDD D5	MDD D6	MDD D7	
Maximum repetitive peak reverse voltage	V_{RMM}	50	100	200	400	600	800	1000	V
Maximum RMS voltage	V_{RMS}	35	70	140	280	420	560	700	V
Maximum DC blocking voltage	V_{DC}	50	100	200	400	600	800	1000	V
Maximum average forward rectified current at TL (see fig. 1)	$I_{(AV)}$	1.0							A
Peak forward surge current 8.3ms single half sine-wave superimposed on rated load (JEDEC Method)	I_{FSM}	25							A
Maximum instantaneous forward voltage at 1.0A	V_F	1.1							V
Maximum DC reverse current $T_A=25^\circ\text{C}$ at rated DC blocking voltage $T_A=125^\circ\text{C}$	I_R	5 50							μA
Typical junction capacitance (NOTE 1)	C_J	5							pF
Typical thermal resistance (NOTE 2)	$R_{\theta JA}$	55.0							$^\circ\text{C}/\text{W}$
Operating junction temperature range	T_J	-55 to +150							$^\circ\text{C}$
Storage temperature range	T_{STG}	-55 to +150							$^\circ\text{C}$

Note: 1. Measured at 1.0MHz and applied reverse voltage of 4.0V D.C.

2. P.C.B. mounted with 2.0" X 2.0" (5 X 5 cm) copper pad areas.

3. The typical data above is for reference only.

Typical Characteristics

Fig.1 Forward Current Derating Curve

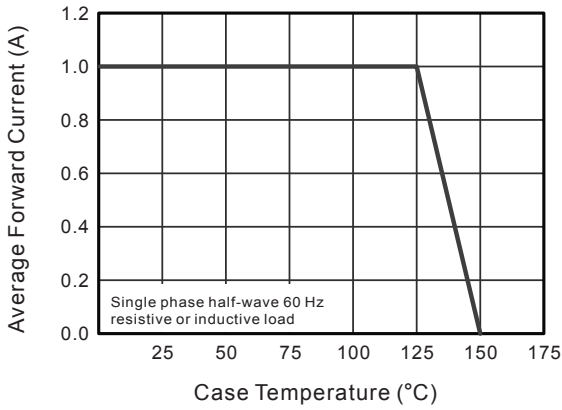

Fig.2 Typical Instantaneous Reverse Characteristics

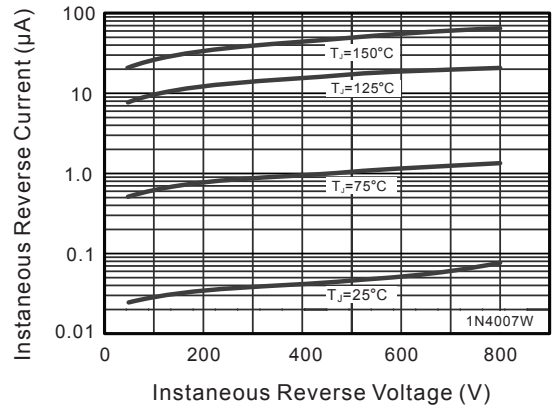

Fig.3 Typical Forward Characteristic

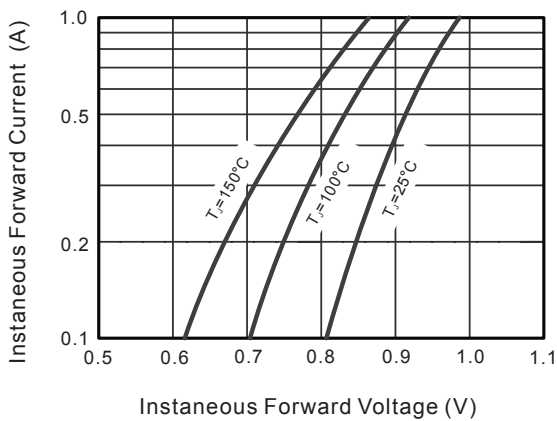

Fig.4 Typical Junction Capacitance

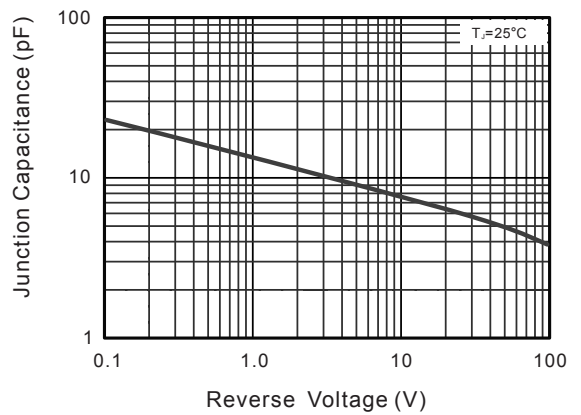
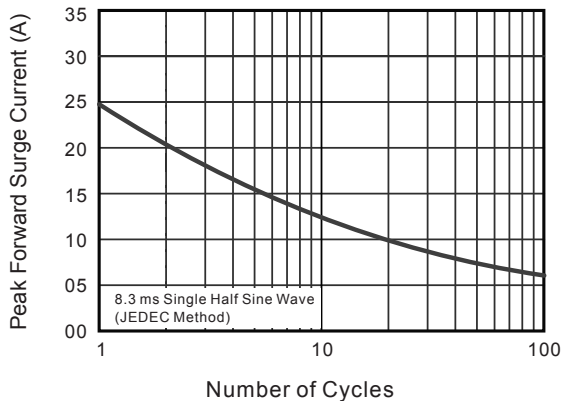
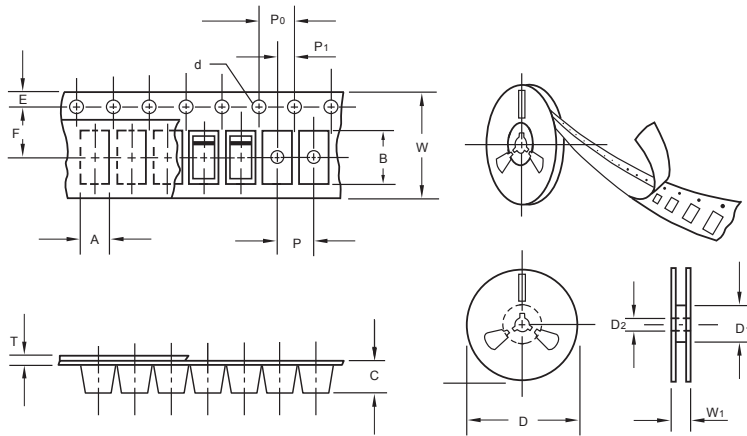

Fig.5 Maximum Non-Repetitive Peak Forward Surge Current



The curve above is for reference only.

Packing information



unit:mm

Item	Symbol	Tolerance	SOD-323
Carrier width	A	0.1	1.46
Carrier length	B	0.1	2.90
Carrier depth	C	0.1	1.25
Sprocket hole	d	0.05	1.50
13" Reel outside diameter	D	2.0	330.00
13" Reel inner diameter	D ₁	min	50.00
7" Reel outside diameter	D	2.0	178.00
7" Reel inner diameter	D ₁	min	54.40
Feed hole diameter	D ₂	0.5	13.00
Sprocket hole position	E	0.1	1.75
Punch hole position	F	0.1	3.50
Punch hole pitch	P	0.1	4.00
Sprocket hole pitch	P ₀	0.1	4.00
Embossment center	P ₁	0.1	2.00
Overall tape thickness	T	0.1	0.06
Tape width	W	0.3	8.00
Reel width	W ₁	1.0	12.30

Note: Devices are packed in accordance with EIA standard RS-481-A and specifications listed above.

Reel packing

PACKAGE	REEL SIZE	REEL (pcs)	COMPONENT SPACING (m/m)	BOX (pcs)	INNER BOX (m/m)	REEL DIA, (m/m)	CARTON SIZE (m/m)	CARTON (pcs)	APPROX. GROSS WEIGHT (kg)
SOD-323	7"	3,000	4.0	45,000	210*208*203	178	430*430*235	180,000	9.0

Suggested Pad Layout



Symbol	Unit (mm)	Unit (inch)
A	1.2	0.047
B	1.2	0.047
C	2.6	0.102
D	1.4	0.055
E	3.8	0.149