

Door Switches with Built-in Basic Switches for Long Life

- Installation in electrical facilities, equipment doors, and other openings helps ensure safety by reliably preventing accidents.
- A Basic Switch is built in to provide a large switching capacity and long service life.

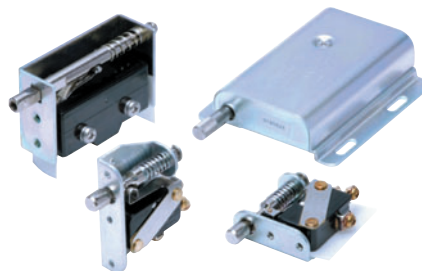

! Be sure to read *Safety Precautions* on page 3 and *Safety Precautions for All Basic Switches*.

Ordering Information

Operation		Built-in Switch	Model
Push operation	Pull operation		
Self-reset	Hold	Z-15GL42-B	1ZAP2
		V-15-1B6	1VAP2-1
		V-15-3B6	1VAP2-2
			1VAP2-6

Contact Form

Model	Name	Contact form
1ZAP2	Double-throw (SPDT)	
1VAP2-1		
1VAP2-2		
1VAP2-6	Single-throw (SPST-NO)	

Specifications

Item	Model	1ZAP2	1VAP2-□
Built-in Switch		Z-15GL42-B	V-15-1B6/V-15-3B6
Rating		15 A, 125 VAC (resistive load)	15 A, 125 VAC (resistive load)
		15 A, 250 V (resistive load)	15 A, 250 V (resistive load)
Ambient operating temperature		-25 to 80°C (with no icing or condensation)	
Ambient operating humidity		35% to 85%RH	
Durability	Mechanical	100,000 operations min.	100,000 operations min.
	Electrical	100,000 operations min.	25,000 operations min.
Degree of protection		IP00	
Electric shock protection class		Class II	
PTI (proof tracking index)		175	
Pollution degree		3 (IEC 947-5-1)	

Note: 1. The 1VAP2-6 is also available with SPDT contacts. The model number is 1VAP2-6 (V-15-1B6).
 2. The built-in switch cannot be replaced.

Dimensions

1ZAP2

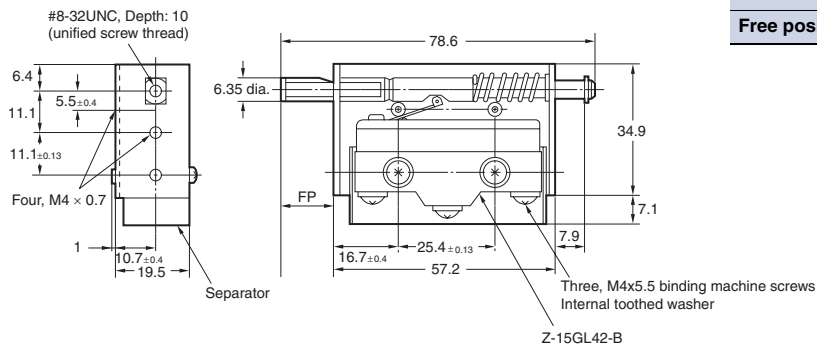
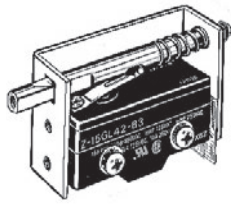

Operating Characteristics	Model	1ZAP2
Operating force	OF max.	21.6 N
Pretravel	PT max.	4.7 mm
Overtravel	OT min.	3.2 mm
Free position	FP max.	11.1 mm

1VAP2-1

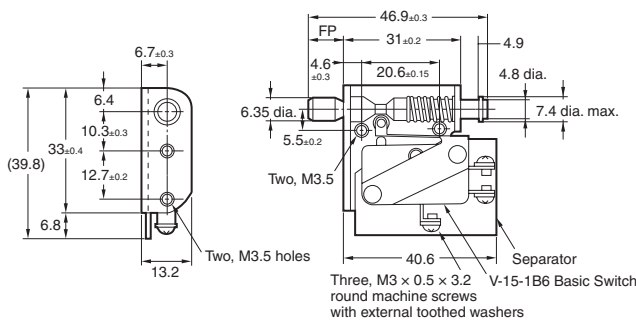
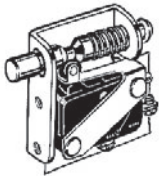

	1VAP2-1
OF max.	17.6 N
PT max.	4.4 mm
OT min.	2 mm
FP max.	9.5 mm

1VAP2-2

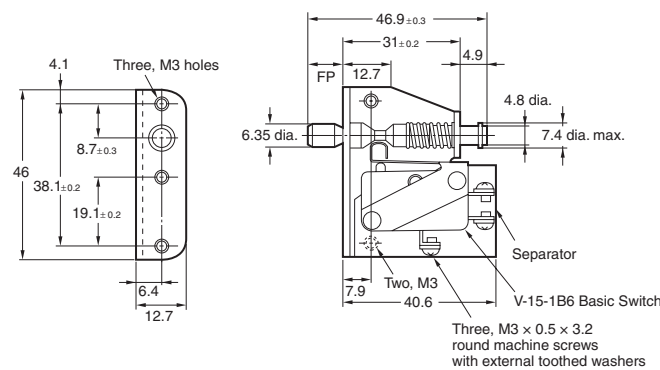
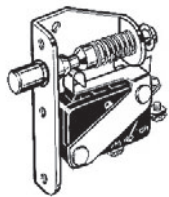

	1VAP2-2
OF max.	17.6 N
PT max.	4.4 mm
OT min.	2 mm
FP max.	9.5 mm

1VAP2-6

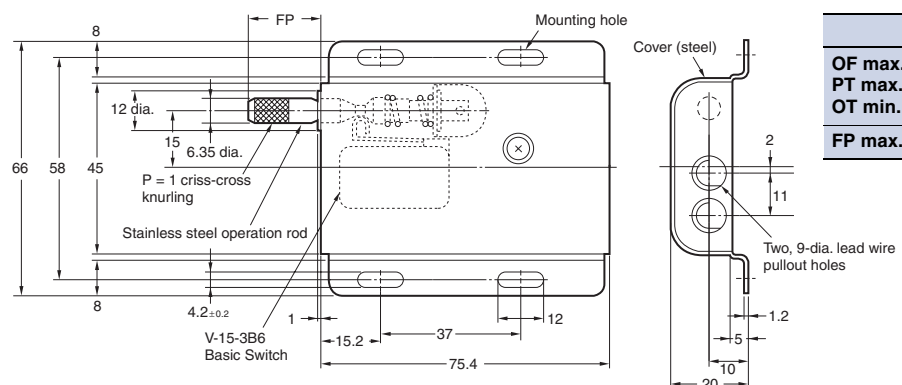
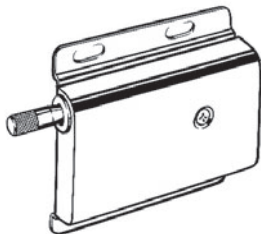

	1VAP2-6
OF max.	14.7 N
PT max.	6 mm
OT min.	3 mm
FP max.	21 mm

Note: 1. The standard 1VAP2-6 has SPST-NO contacts.

2. The 1VAP2-6 is also available with SPDT contacts. If SPDT contacts are required, order using the following model number. (The built-in switch is the V-15-1B6.)
1VAP2-6 (V-15-1B6)

Safety Precautions

Refer to *Safety Precautions for All Basic Switches*.

Precautions for Correct Use

Mounting Holes

Mounting direction	1ZAP2	1VAP2-1	1VAP2-2	1VAP2-6
Front mounting	<p>Two, 4.5^{+0.3}/₀ dia. holes 25.4_{±0.3}</p>	<p>Two, 4^{+0.3}/₀ dia. holes 20.6_{±0.3}</p>	<p>Two, 3.5^{+0.3}/₀ dia. holes 38.1_{±0.3}</p>	<p>Four, M4 or 4.5^{+0.3}/₀ dia. holes 37_{±0.3} 58_{±0.3}</p>
Side mounting	<p>10 dia. min. 11.1_{±0.3} 11.1_{±0.3} Two, 4.5^{+0.3}/₀ dia. holes</p>	<p>10 dia. min. 10.3_{±0.3} 12.7_{±0.3} Two, 4^{+0.3}/₀ dia. holes</p>	<p>10 dia. min. 8.7_{±0.3} 38.1_{±0.3} 19.1_{±0.3} Two, 3.5^{+0.3}/₀ dia. holes</p>	(Side mounting is not possible)

Wiring

Tighten the terminal screws to the torque given in the following table.

1ZAP2	1VAP2
0.78 to 1.78 N·m	0.19 to 0.29 N·m

Operating Environment

- The Switch does not have a water-resistant structure. Take measures to protect the Switch if it is to be used in locations subject to splashing or spraying water or other liquids.
- Do not use the Switch where it is continuously subjected to vibration or shock. Doing so will result in contact failure, malfunction, or a decrease in service life caused by abrasive powder that is generated from the internal parts. Subjecting the Switch to excessive vibration or shock may cause the contacts to malfunction, stick, or become damaged. Make sure to install the Switch in locations free of vibration or shock or in a direction where resonance will not occur.
- Do not use the Switch in locations subject to corrosive gas, such as sulfuric gas (H₂S or SO₂), ammonium gas (NH₃), nitric gas (HNO₃), or chlorine gas (Cl₂), or high temperature and humidity. Doing so will result in damage due to contact failure or corrosion.
- If the Switch is used in locations with silicone gas, arc energy may cause silicon dioxide (SiO₂) to build up on the contacts and contact failure may result. If there is silicone oil, silicone sealant, or wire covered with silicone close to the Switch, attach a contact protective circuit to suppress the arcing of the Switch or eliminate the source of silicone gas.
- Use the switch within the specified range for operating temperature and humidity. Using the Switch in high temperatures will cause the operating characteristics to deviate. Rapid changes in temperature will also cause the operating characteristics to deviate. It is recommended to install the Switch as far as possible from heat sources so that the temperature of the Switch is not affected.

Read and Understand This Catalog

Please read and understand this catalog before purchasing the products. Please consult your OMRON representative if you have any questions or comments.

Warranty and Limitations of Liability

WARRANTY

OMRON's exclusive warranty is that the products are free from defects in materials and workmanship for a period of one year (or other period if specified) from date of sale by OMRON.

OMRON MAKES NO WARRANTY OR REPRESENTATION, EXPRESS OR IMPLIED, REGARDING NON-INFRINGEMENT, MERCHANTABILITY, OR FITNESS FOR PARTICULAR PURPOSE OF THE PRODUCTS. ANY BUYER OR USER ACKNOWLEDGES THAT THE BUYER OR USER ALONE HAS DETERMINED THAT THE PRODUCTS WILL SUITABLY MEET THE REQUIREMENTS OF THEIR INTENDED USE. OMRON DISCLAIMS ALL OTHER WARRANTIES, EXPRESS OR IMPLIED.

LIMITATIONS OF LIABILITY

OMRON SHALL NOT BE RESPONSIBLE FOR SPECIAL, INDIRECT, OR CONSEQUENTIAL DAMAGES, LOSS OF PROFITS OR COMMERCIAL LOSS IN ANY WAY CONNECTED WITH THE PRODUCTS, WHETHER SUCH CLAIM IS BASED ON CONTRACT, WARRANTY, NEGLIGENCE, OR STRICT LIABILITY.

In no event shall the responsibility of OMRON for any act exceed the individual price of the product on which liability is asserted.

IN NO EVENT SHALL OMRON BE RESPONSIBLE FOR WARRANTY, REPAIR, OR OTHER CLAIMS REGARDING THE PRODUCTS UNLESS OMRON'S ANALYSIS CONFIRMS THAT THE PRODUCTS WERE PROPERLY HANDLED, STORED, INSTALLED, AND MAINTAINED AND NOT SUBJECT TO CONTAMINATION, ABUSE, MISUSE, OR INAPPROPRIATE MODIFICATION OR REPAIR.

Application Considerations

SUITABILITY FOR USE

OMRON shall not be responsible for conformity with any standards, codes, or regulations that apply to the combination of products in the customer's application or use of the products.

At the customer's request, OMRON will provide applicable third party certification documents identifying ratings and limitations of use that apply to the products. This information by itself is not sufficient for a complete determination of the suitability of the products in combination with the end product, machine, system, or other application or use.

The following are some examples of applications for which particular attention must be given. This is not intended to be an exhaustive list of all possible uses of the products, nor is it intended to imply that the uses listed may be suitable for the products:

- Outdoor use, uses involving potential chemical contamination or electrical interference, or conditions or uses not described in this catalog.
- Nuclear energy control systems, combustion systems, railroad systems, aviation systems, medical equipment, amusement machines, vehicles, safety equipment, and installations subject to separate industry or government regulations.
- Systems, machines, and equipment that could present a risk to life or property.

Please know and observe all prohibitions of use applicable to the products.

NEVER USE THE PRODUCTS FOR AN APPLICATION INVOLVING SERIOUS RISK TO LIFE OR PROPERTY WITHOUT ENSURING THAT THE SYSTEM AS A WHOLE HAS BEEN DESIGNED TO ADDRESS THE RISKS, AND THAT THE OMRON PRODUCTS ARE PROPERLY RATED AND INSTALLED FOR THE INTENDED USE WITHIN THE OVERALL EQUIPMENT OR SYSTEM.

PROGRAMMABLE PRODUCTS

OMRON shall not be responsible for the user's programming of a programmable product, or any consequence thereof.

Disclaimers

CHANGE IN SPECIFICATIONS

Product specifications and accessories may be changed at any time based on improvements and other reasons.

It is our practice to change model numbers when published ratings or features are changed, or when significant construction changes are made. However, some specifications of the products may be changed without any notice. When in doubt, special model numbers may be assigned to fix or establish key specifications for your application on your request. Please consult with your OMRON representative at any time to confirm actual specifications of purchased products.

DIMENSIONS AND WEIGHTS

Dimensions and weights are nominal and are not to be used for manufacturing purposes, even when tolerances are shown.

PERFORMANCE DATA

Performance data given in this catalog is provided as a guide for the user in determining suitability and does not constitute a warranty. It may represent the result of OMRON's test conditions, and the users must correlate it to actual application requirements. Actual performance is subject to the OMRON Warranty and Limitations of Liability.

ERRORS AND OMISSIONS

The information in this document has been carefully checked and is believed to be accurate; however, no responsibility is assumed for clerical, typographical, or proofreading errors, or omissions.

2012.8

In the interest of product improvement, specifications are subject to change without notice.

OMRON Corporation
Industrial Automation Company

<http://www.ia.omron.com/>

(c)Copyright OMRON Corporation 2012 All Right Reserved.