



Is Now Part of



ON Semiconductor®

To learn more about ON Semiconductor, please visit our website at
www.onsemi.com

Please note: As part of the Fairchild Semiconductor integration, some of the Fairchild orderable part numbers will need to change in order to meet ON Semiconductor's system requirements. Since the ON Semiconductor product management systems do not have the ability to manage part nomenclature that utilizes an underscore (_), the underscore (_) in the Fairchild part numbers will be changed to a dash (-). This document may contain device numbers with an underscore (_). Please check the ON Semiconductor website to verify the updated device numbers. The most current and up-to-date ordering information can be found at www.onsemi.com. Please email any questions regarding the system integration to Fairchild_questions@onsemi.com.

ON Semiconductor and the ON Semiconductor logo are trademarks of Semiconductor Components Industries, LLC dba ON Semiconductor or its subsidiaries in the United States and/or other countries. ON Semiconductor owns the rights to a number of patents, trademarks, copyrights, trade secrets, and other intellectual property. A listing of ON Semiconductor's product/patent coverage may be accessed at www.onsemi.com/site/pdf/Patent-Marking.pdf. ON Semiconductor reserves the right to make changes without further notice to any products herein. ON Semiconductor makes no warranty, representation or guarantee regarding the suitability of its products for any particular purpose, nor does ON Semiconductor assume any liability arising out of the application or use of any product or circuit, and specifically disclaims any and all liability, including without limitation special, consequential or incidental damages. Buyer is responsible for its products and applications using ON Semiconductor products, including compliance with all laws, regulations and safety requirements or standards, regardless of any support or applications information provided by ON Semiconductor. "Typical" parameters which may be provided in ON Semiconductor data sheets and/or specifications can and do vary in different applications and actual performance may vary over time. All operating parameters, including "Typicals" must be validated for each customer application by customer's technical experts. ON Semiconductor does not convey any license under its patent rights nor the rights of others. ON Semiconductor products are not designed, intended, or authorized for use as a critical component in life support systems or any FDA Class 3 medical devices or medical devices with a same or similar classification in a foreign jurisdiction or any devices intended for implantation in the human body. Should Buyer purchase or use ON Semiconductor products for any such unintended or unauthorized application, Buyer shall indemnify and hold ON Semiconductor and its officers, employees, subsidiaries, affiliates, and distributors harmless against all claims, costs, damages, and expenses, and reasonable attorney fees arising out of, directly or indirectly, any claim of personal injury or death associated with such unintended or unauthorized use, even if such claim alleges that ON Semiconductor was negligent regarding the design or manufacture of the part. ON Semiconductor is an Equal Opportunity/Affirmative Action Employer. This literature is subject to all applicable copyright laws and is not for resale in any manner.



FDC6330L

FDC6330L

Integrated Load Switch

General Description

This device is particularly suited for compact power management in portable electronic equipment where 3V to 20V input and 2.3A output current capability are needed. This load switch integrates a small N-Channel power MOSFET (Q1) which drives a large P-Channel power MOSFET (Q2) in one tiny SuperSOT™-6 package.

Features

- $V_{DROP} = 0.2V @ V_{IN} = 12V, I_L = 2.5 A. R_{(ON)} = 0.08 \Omega$
 $V_{DROP} = 0.2V @ V_{IN} = 5V, I_L = 1.6 A. R_{(ON)} = 0.125 \Omega.$
- Control MOSFET (Q1) includes Zener protection for ESD ruggedness (>6kV Human Body Model).
- High performance PowerTrench™ technology for extremely low on-resistance.
- SuperSOT™-6 package design using copper lead frame for superior thermal and electrical capabilities.

Applications

- Power management
- Load actuation

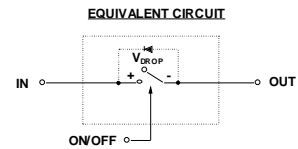
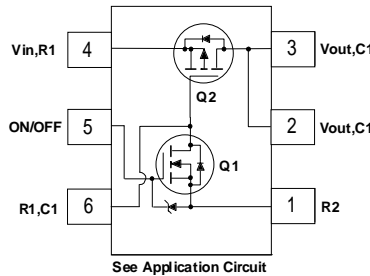

SuperSOT™-6

Absolute Maximum Ratings T_A=25°C unless otherwise noted

Symbol	Parameter	Ratings	Units
V _{IN}	Input Voltage Range (Note 1)	3 - 20	V
V _{ON/OFF}	On/Off Voltage Range	1.5 - 8	V
I _D	Load Current - Continuous (Note 2)	2.3	A
		10	
P _D	Maximum Power Dissipation (Note 1)	0.7	W
T _J , T _{stg}	Operating and Storage Temperature Range	-55 to +150	°C
ESD	Electrostatic Discharge Rating MIL-STD-883D Human-Body-Model (100pf/1500 Ohm)	6	kV

Thermal Characteristics

R _{θJA}	Thermal Resistance, Junction-to-Ambient (Note 2)	180	°C/W
R _{θJC}	Thermal Resistance, Junction-to-Case (Note 2)	60	°C/W

Package Marking and Ordering Information

Device Marking	Device	Reel Size	Tape width	Quantity
.330 (. Denotes pin 1)	FDC6330L	7"	8mm	3000 units

Electrical Characteristics T_A=25°C unless otherwise noted

Symbol	Parameter	Test Conditions	Min	Typ	Max	Units
OFF Characteristics						
I _{FL}	Leakage Current	V _{IN} = 20 V, V _{ON/OFF} = 0 V			1	μA
ON Characteristics (Note 3)						
V _{DROP}	Conduction Voltage	V _{IN} = 12 V, V _{ON/OFF} = 3.3 V, I _L = 2.5 A			0.2	V
		V _{IN} = 5 V, V _{ON/OFF} = 3.3 V, I _L = 1.6 A			0.2	V
R _(ON)	Q ₂ - Static On-Resistance	V _{GS} = -12 V, I _D = -2.3 A V _{GS} = -5 V, I _D = -1.9 A		0.054 0.081	0.08 0.125	Ω
I _L	Load Current	V _{DROP} = 0.2 V, V _{IN} = 12 V, V _{ON/OFF} = 3.3 V	2.5			A
		V _{DROP} = 0.2 V, V _{IN} = 5 V, V _{ON/OFF} = 3.3 V	1.6			

Notes:

1. Range of V_{in} can be up to 30V, but R₁ and R₂ must be scaled such that V_{GS} of Q2 does not exceed 20V.
2. R_{θJA} is the sum of the junction-to-case and case-to-ambient thermal resistance where the case thermal reference is defined as the solder mounting surface of the drain pins. R_{θJC} is guaranteed by design while R_{θJA} is determined by the user's board design.
3. Pulse Test: Pulse Width ≤ 300μs, Duty Cycle ≤ 2.0%.

FDC6330L Load Switch Application

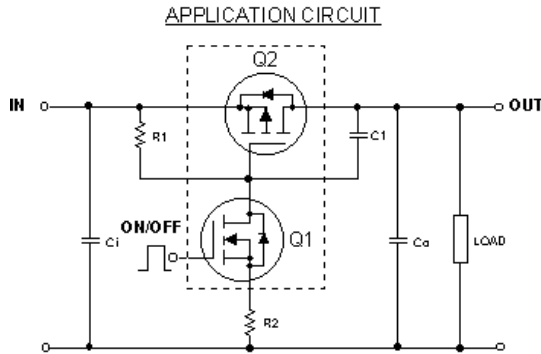

External Component Recommendation:

- For applications where Co ≤ 1μF.
- For slew rate control, select R2 in the range of 1k - 4.7kΩ .
- For additional in-rush current control, C1 ≤ 1000pF can be added.
- Select R1 so that the R1/R2 ratio ranges from 10 - 100. R1 is required to turn Q2 off.

Typical Characteristics (continued)

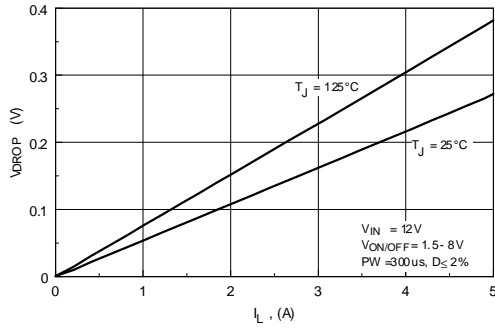

Figure 1. Conduction Voltage Drop Variation with Load Current.

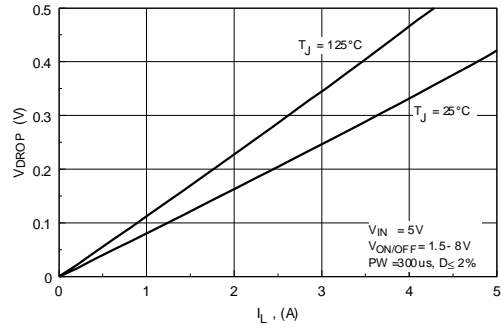

Figure 2. Conduction Voltage Drop Variation with Load Current.

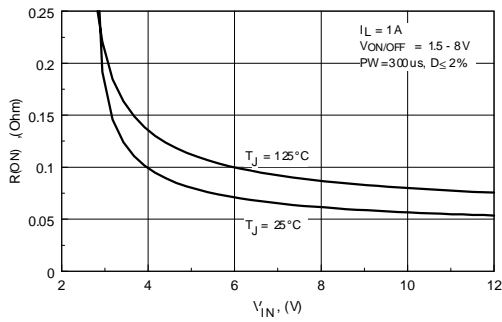

Figure 3. On-Resistance Variation with Input Voltage.

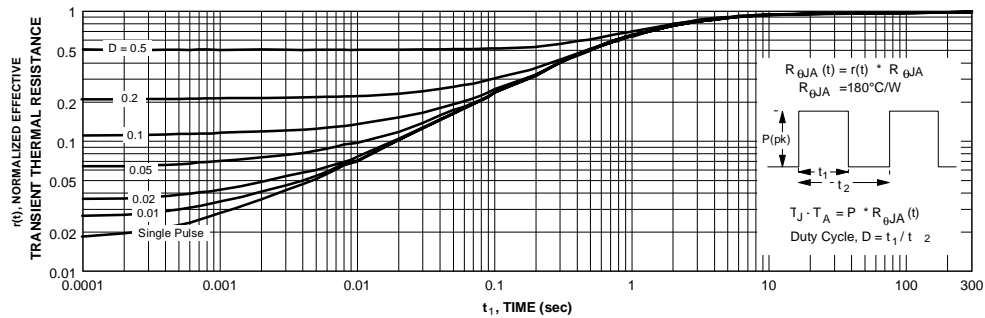
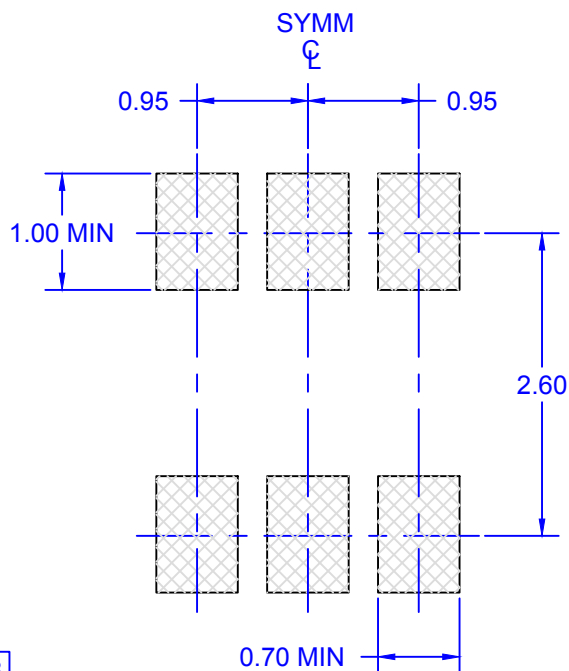
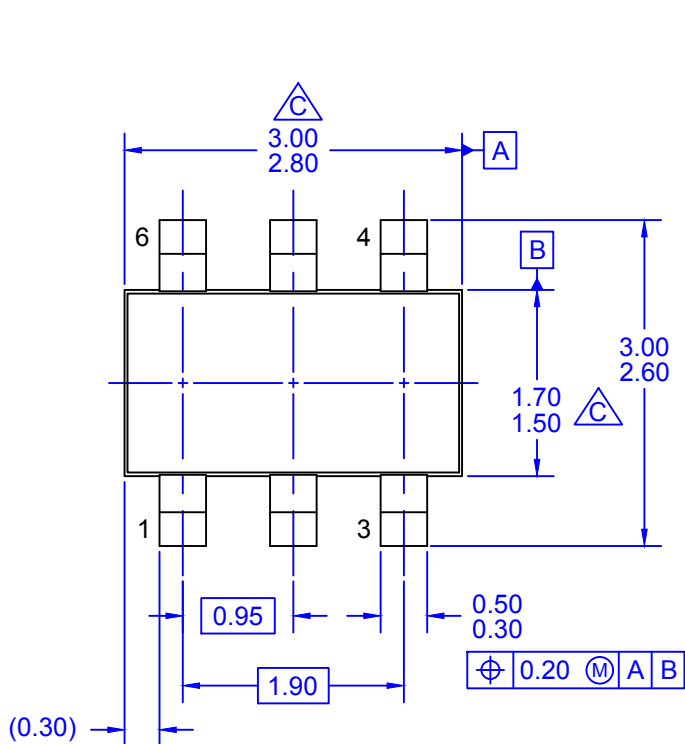
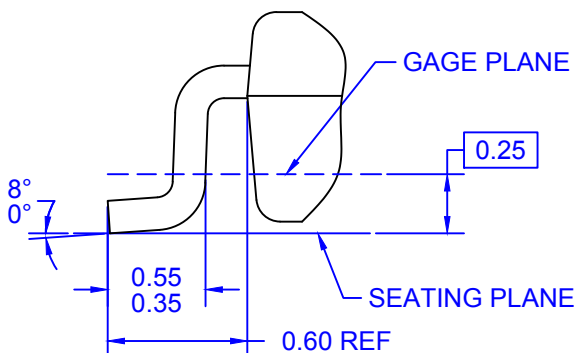
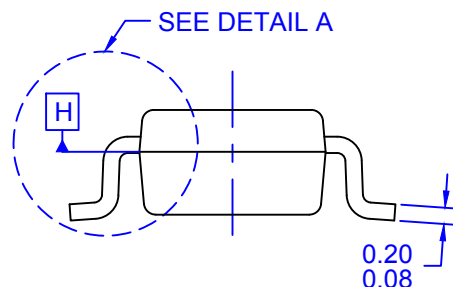
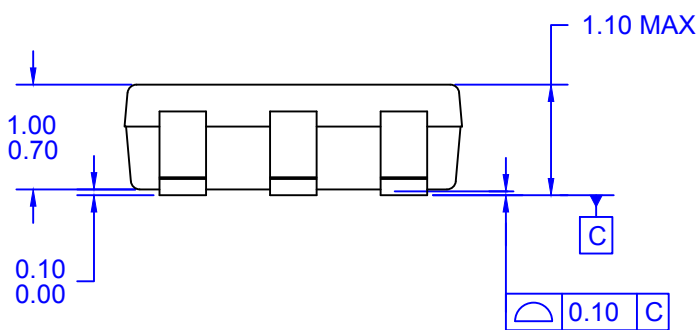

Figure 4. Transient Thermal Response Curve.

Thermal characterization performed using the conditions described in Note 2. Transient thermal response will change depending on the circuit board design.



LAND PATTERN RECOMMENDATION



DETAIL A
SCALE: 50X

- NOTES: UNLESS OTHERWISE SPECIFIED
- A) THIS PACKAGE CONFORMS TO JEDEC MO-193. VAR. AA, ISSUE E.
 - B) ALL DIMENSIONS ARE IN MILLIMETERS.
 - C) PACKAGE LENGTH DOES NOT INCLUDE MOLD FLASH, PROTRUSIONS OR GATE BURRS. MOLD FLASH, PROTRUSIONS OR GATE BURRS SHALL NOT EXCEED 0.25mm PER END. PACKAGE WIDTH DOES NOT INCLUDE INTERLEAD FLASH OR PROTRUSION. INTERLEAD FLASH OR PROTRUSION SHALL NOT EXCEED 0.25mm PER SIDE. PACKAGE LENGTH AND WIDTH DIMENSIONS ARE DETERMINED AT DATUM H.
 - D) DRAWING FILE NAME: MKT-MA06AREVF

ON Semiconductor



ON Semiconductor and  are trademarks of Semiconductor Components Industries, LLC dba ON Semiconductor or its subsidiaries in the United States and/or other countries. ON Semiconductor owns the rights to a number of patents, trademarks, copyrights, trade secrets, and other intellectual property. A listing of ON Semiconductor's product/patent coverage may be accessed at www.onsemi.com/site/pdf/Patent-Marking.pdf. ON Semiconductor reserves the right to make changes without further notice to any products herein. ON Semiconductor makes no warranty, representation or guarantee regarding the suitability of its products for any particular purpose, nor does ON Semiconductor assume any liability arising out of the application or use of any product or circuit, and specifically disclaims any and all liability, including without limitation special, consequential or incidental damages. Buyer is responsible for its products and applications using ON Semiconductor products, including compliance with all laws, regulations and safety requirements or standards, regardless of any support or applications information provided by ON Semiconductor. "Typical" parameters which may be provided in ON Semiconductor data sheets and/or specifications can and do vary in different applications and actual performance may vary over time. All operating parameters, including "Typicals" must be validated for each customer application by customer's technical experts. ON Semiconductor does not convey any license under its patent rights nor the rights of others. ON Semiconductor products are not designed, intended, or authorized for use as a critical component in life support systems or any FDA Class 3 medical devices or medical devices with a same or similar classification in a foreign jurisdiction or any devices intended for implantation in the human body. Should Buyer purchase or use ON Semiconductor products for any such unintended or unauthorized application, Buyer shall indemnify and hold ON Semiconductor and its officers, employees, subsidiaries, affiliates, and distributors harmless against all claims, costs, damages, and expenses, and reasonable attorney fees arising out of, directly or indirectly, any claim of personal injury or death associated with such unintended or unauthorized use, even if such claim alleges that ON Semiconductor was negligent regarding the design or manufacture of the part. ON Semiconductor is an Equal Opportunity/Affirmative Action Employer. This literature is subject to all applicable copyright laws and is not for resale in any manner.

PUBLICATION ORDERING INFORMATION

LITERATURE FULFILLMENT:

Literature Distribution Center for ON Semiconductor
19521 E. 32nd Pkwy, Aurora, Colorado 80011 USA
Phone: 303-675-2175 or 800-344-3860 Toll Free USA/Canada
Fax: 303-675-2176 or 800-344-3867 Toll Free USA/Canada
Email: orderlit@onsemi.com

N. American Technical Support: 800-282-9855 Toll Free
USA/Canada
Europe, Middle East and Africa Technical Support:
Phone: 421 33 790 2910
Japan Customer Focus Center
Phone: 81-3-5817-1050

ON Semiconductor Website: www.onsemi.com
Order Literature: <http://www.onsemi.com/orderlit>
For additional information, please contact your local
Sales Representative