

SAMZO REAC/ROHS

REV	ECN NO	DESCRIPTION	DESIGN	APPROVAL	DATE
A1	NEW	Replace frame			2018.06.12

主要技术参数、性能  
The Main Thchnology Performance

额定电流、电压 Rate voltage, current	50mA DC12V
接触电阻 Contact resistance	≤100mΩ
按力 Operating force	±100gf
行程 Travel	0.3±0.10mm
绝缘电阻 Insulated resistance	≥100MΩ
介电强度 Dielectric strength	≥250VAC/1min

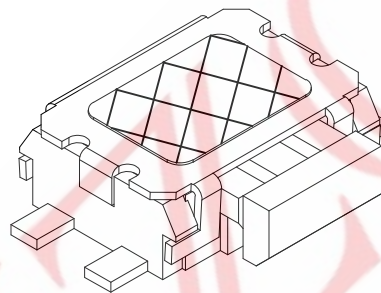
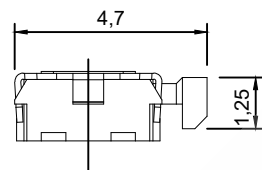
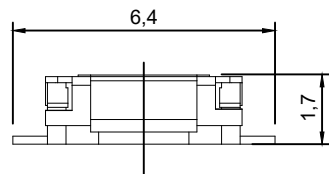
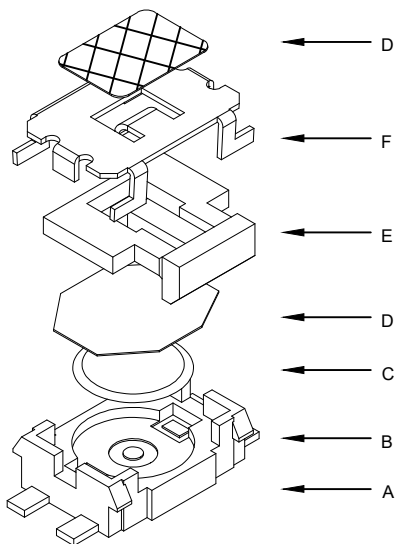

C 5 B 170 \* 1 1 0  
A B C D E F G H

- A. 系列:C-微型侧按
- B. 贴装方式:5-卧式贴片
- C. 引脚规格:B-4PIN
- D. 操作高度:170-1.70mm
- E. 操作力度:1-160/2-260gf
- F. 操作寿命:1-30,000/次
- G. 固定方式:1-无柱
- H. 物料编码:0-常规

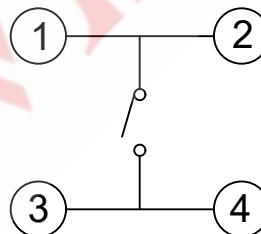
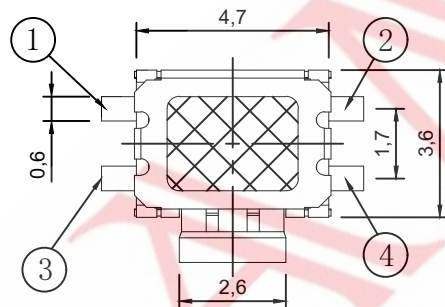

电路图

CIRCUIT DIAGRAM

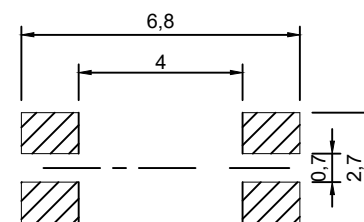

PCB. 焊接图

PCB. WELDING DRAWING

F	盖板	不锈钢	1	清洗
E	按钮	PPA	1	黑色
D	防水层	聚酰亚胺	/	橙黄色
C	弹片	不锈钢	1	镀银
B	本体	LCP	1	黑色
A	卡件	黄铜	1	镀银
项目 ITEM	名称 DESCRIPTION	材质 MATERIAL	数量 QTY	表面处理/颜色 FINISH/COLOR

GENERAL TOLERANCE			
DESIGN	WANGUIFA	2018.06.12	≥0~2< ±0.15
CHECKED	ZHENGUILAN	2018.06.12	≥2~5< ±0.25
APPROVED	LILIANJIANG	2018.06.14	≥5 ±0.35

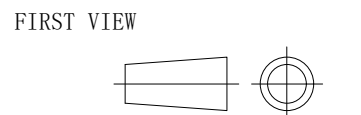

The copyright belongs to samzo parts [China] Co., Ltd. please use the material after samzo parts agree to authorize. The final right of interpretation belongs to samzo parts.  
WWW.KKK-JP.COM

**SAMZO COMPONENTS**  
Electronic switch and connector manufacturer

TITLE: 3.6*4.7*1.7 侧按四脚中龟
DWG NO: C5B170-P3011
PART NO: C5B1701938
MODEL NO: C5B170-* -110
NAME: TACT SWITCH