

### GENERAL DESCRIPTION

The SGM2040 is an ultra-low current consumption, low dropout voltage and high accuracy linear regulator. It is capable of supplying 250mA output current with only 1 $\mu$ A (TYP) current consumption. The typical dropout voltage is only 60mV at 100mA. The operating input voltage range is from 1.7V to 7.5V and fixed output voltages are 1.2V, 1.5V, 1.8V, 2.5V, 2.8V, 3.0V, 3.3V, 3.6V, 4.0V, 4.2V and 5.0V.

Other features include logic-controlled shutdown mode, short-circuit current limit and thermal shutdown protection. The SGM2040 has automatic discharge function to quickly discharge  $V_{OUT}$  in the disabled status.

The SGM2040 is available in Green SOT-23-5 and UTDFN-1 $\times$ 1-4AL packages. It operates over an operating temperature range of -40 $^{\circ}$ C to +85 $^{\circ}$ C.

### FEATURES

- Operating Input Voltage Range: 1.7V to 7.5V
- Fixed Outputs of 1.2V, 1.5V, 1.8V, 2.5V, 2.8V, 3.0V, 3.3V, 3.6V, 4.0V, 4.2V and 5.0V
- 250mA Output Current
- High Output Voltage Accuracy:  $\pm 1.2\%$  at +25 $^{\circ}$ C
- Ultra-Low Current Consumption: 1 $\mu$ A (TYP)
- Low Dropout Voltage: 60mV (TYP) at 100mA
- Low Reverse Leakage Current: 0.4 $\mu$ A (TYP) when  $V_{OUT} > V_{IN}$
- Current Limiting and Thermal Protection
- With Output Automatic Discharge
- -40 $^{\circ}$ C to +85 $^{\circ}$ C Operating Temperature Range
- Available in Green SOT-23-5 and UTDFN-1 $\times$ 1-4AL Packages

### APPLICATIONS

- Wearable Device
- Smart Phone
- Portable Equipment

### TYPICAL APPLICATION

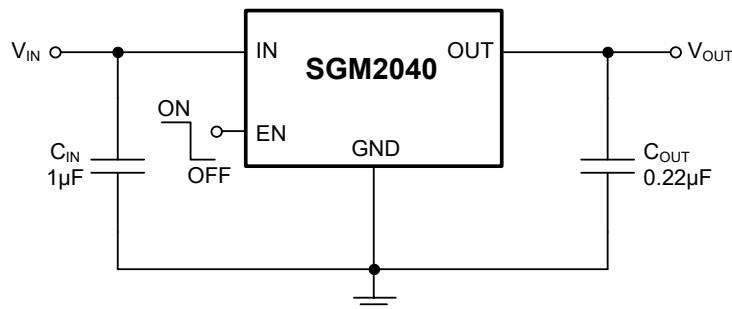

Figure 1. Typical Application Circuit

**PACKAGE/ORDERING INFORMATION**

MODEL	PACKAGE DESCRIPTION	SPECIFIED TEMPERATURE RANGE	ORDERING NUMBER	PACKAGE MARKING	PACKING OPTION
SGM2040-1.2	SOT-23-5	-40°C to +85°C	SGM2040-1.2YN5G/TR	MBEXX	Tape and Reel, 3000
SGM2040-1.5	SOT-23-5	-40°C to +85°C	SGM2040-1.5YN5G/TR	MC5XX	Tape and Reel, 3000
SGM2040-1.8	SOT-23-5	-40°C to +85°C	SGM2040-1.8YN5G/TR	M65XX	Tape and Reel, 3000
SGM2040-2.5	SOT-23-5	-40°C to +85°C	SGM2040-2.5YN5G/TR	MBDXX	Tape and Reel, 3000
SGM2040-2.8	SOT-23-5	-40°C to +85°C	SGM2040-2.8YN5G/TR	M66XX	Tape and Reel, 3000
SGM2040-3.0	SOT-23-5	-40°C to +85°C	SGM2040-3.0YN5G/TR	GPAXX	Tape and Reel, 3000
SGM2040-3.3	SOT-23-5	-40°C to +85°C	SGM2040-3.3YN5G/TR	M67XX	Tape and Reel, 3000
SGM2040-3.6	SOT-23-5	-40°C to +85°C	SGM2040-3.6YN5G/TR	MBFXX	Tape and Reel, 3000
SGM2040-4.0	SOT-23-5	-40°C to +85°C	SGM2040-4.0YN5G/TR	MC0XX	Tape and Reel, 3000
SGM2040-4.2	SOT-23-5	-40°C to +85°C	SGM2040-4.2YN5G/TR	MC1XX	Tape and Reel, 3000
SGM2040-5.0	SOT-23-5	-40°C to +85°C	SGM2040-5.0YN5G/TR	M2FXX	Tape and Reel, 3000
SGM2040-1.2	UTDFN-1×1-4AL	-40°C to +85°C	SGM2040-1.2YUDH4G/TR	C6X	Tape and Reel, 10000
SGM2040-1.5	UTDFN-1×1-4AL	-40°C to +85°C	SGM2040-1.5YUDH4G/TR	C7X	Tape and Reel, 10000
SGM2040-1.8	UTDFN-1×1-4AL	-40°C to +85°C	SGM2040-1.8YUDH4G/TR	69X	Tape and Reel, 10000
SGM2040-2.5	UTDFN-1×1-4AL	-40°C to +85°C	SGM2040-2.5YUDH4G/TR	C8X	Tape and Reel, 10000
SGM2040-2.8	UTDFN-1×1-4AL	-40°C to +85°C	SGM2040-2.8YUDH4G/TR	6AX	Tape and Reel, 10000
SGM2040-3.0	UTDFN-1×1-4AL	-40°C to +85°C	SGM2040-3.0YUDH4G/TR	C9X	Tape and Reel, 10000
SGM2040-3.3	UTDFN-1×1-4AL	-40°C to +85°C	SGM2040-3.3YUDH4G/TR	6BX	Tape and Reel, 10000
SGM2040-3.6	UTDFN-1×1-4AL	-40°C to +85°C	SGM2040-3.6YUDH4G/TR	CAX	Tape and Reel, 10000
SGM2040-4.0	UTDFN-1×1-4AL	-40°C to +85°C	SGM2040-4.0YUDH4G/TR	CBX	Tape and Reel, 10000
SGM2040-4.2	UTDFN-1×1-4AL	-40°C to +85°C	SGM2040-4.2YUDH4G/TR	CCX	Tape and Reel, 10000
SGM2040-5.0	UTDFN-1×1-4AL	-40°C to +85°C	SGM2040-5.0YUDH4G/TR	CDX	Tape and Reel, 10000

**MARKING INFORMATION**

NOTE: XX = Date Code. X = Date Code.

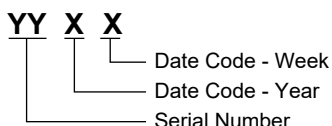
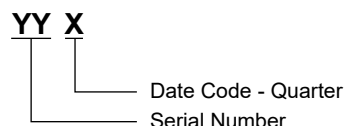
**SOT-23-5**

**UTDFN-1×1-4AL**

Green (RoHS & HSF): SG Micro Corp defines "Green" to mean Pb-Free (RoHS compatible) and free of halogen substances. If you have additional comments or questions, please contact your SGMICRO representative directly.

**ABSOLUTE MAXIMUM RATINGS**

IN to GND .....	-0.3V to 8V
OUT to GND .....	-0.3V to 6V
EN to GND .....	-0.3V to 6V
Package Thermal Resistance	
SOT-23-5, $\theta_{JA}$ .....	207°C/W
UTDFN-1×1-4AL, $\theta_{JA}$ .....	238°C/W
Junction Temperature .....	+150°C
Storage Temperature Range .....	-65°C to +150°C
Lead Temperature (Soldering, 10s) .....	+260°C
ESD Susceptibility	
HBM .....	7000V
MM .....	300V
CDM .....	1000V

**RECOMMENDED OPERATING CONDITIONS**

Input Voltage Range .....	1.7V to 7.5V
Input Effective Capacitance, $C_{IN}$ .....	0.5µF (MIN)
Output Effective Capacitance, $C_{OUT}$ .....	0.1µF to 10µF
Operating Junction Temperature Range .....	-40°C to +85°C

**OVERSTRESS CAUTION**

Stresses beyond those listed in Absolute Maximum Ratings may cause permanent damage to the device. Exposure to absolute maximum rating conditions for extended periods may affect reliability. Functional operation of the device at any conditions beyond those indicated in the Recommended Operating Conditions section is not implied.

**ESD SENSITIVITY CAUTION**

This integrated circuit can be damaged if ESD protections are not considered carefully. SGMICRO recommends that all integrated circuits be handled with appropriate precautions. Failure to observe proper handling and installation procedures can cause damage. ESD damage can range from subtle performance degradation to complete device failure. Precision integrated circuits may be more susceptible to damage because even small parametric changes could cause the device not to meet the published specifications.

**DISCLAIMER**

SG Micro Corp reserves the right to make any change in circuit design, or specifications without prior notice.

## PIN CONFIGURATIONS

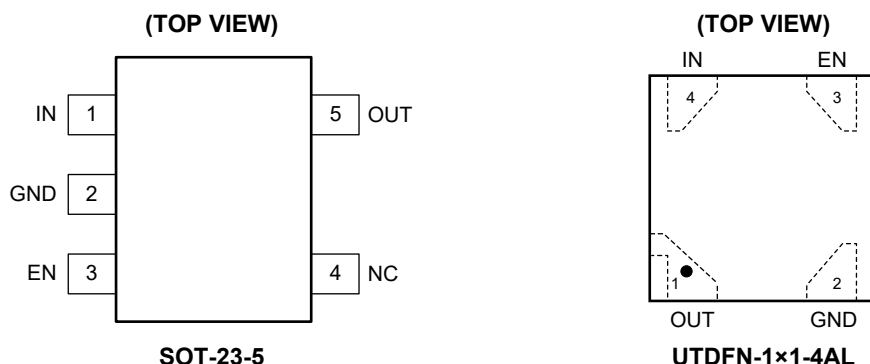

## PIN DESCRIPTION

PIN		NAME	FUNCTION
SOT-23-5	UTDFN-1x1-4AL		
1	4	IN	Input Supply Voltage Pin. It is recommended to use a 1 $\mu$ F or larger ceramic capacitor from IN pin to ground to get good power supply decoupling. This ceramic capacitor should be placed as close as possible to IN pin.
2	2	GND	Ground Pin.
3	3	EN	Enable Pin. Drive EN high to turn on the regulator. Drive EN low to turn off the regulator. The EN pin has an internal pull-down current source.
4	–	NC	Not Connection.
5	1	OUT	Regulator Output Pin. It is recommended to use a ceramic capacitor with effective capacitance in the range of 0.1 $\mu$ F to 10 $\mu$ F to ensure stability. This ceramic capacitor should be placed as close as possible to OUT pin.

## ELECTRICAL CHARACTERISTICS

( $V_{IN} = V_{OUT(NOM)} + 1V$ ,  $I_{OUT} = 0.1mA$ ,  $V_{EN} = 5V$ ,  $C_{IN} = 1\mu F$  and  $C_{OUT} = 0.22\mu F$ , Full =  $-40^{\circ}C$  to  $+85^{\circ}C$ , typical values are at  $T_J = +25^{\circ}C$ , unless otherwise noted.)

PARAMETER	SYMBOL	CONDITIONS	TEMP	MIN	TYP	MAX	UNITS	
Input Voltage Range	$V_{IN}$		Full	1.7		7.5	V	
Output Voltage Accuracy	$V_{OUT}$	$V_{IN} = (V_{OUT(NOM)} + 1V)$ to 7.5V	+25°C	-1.2		1.2	%	
			Full	-2.5		2.5		
Maximum Output Current			+25°C	250			mA	
Output Current Limit	$I_{LIMIT}$		+25°C	280	480		mA	
Supply Pin Current	$I_Q$	No load	Full		1.0	1.5	µA	
Dropout Voltage <sup>(1)</sup>	$V_{DROP}$	$I_{OUT} = 100mA$ , SOT-23-5	$1.8V \leq V_{OUT(NOM)} < 2.5V$	+25°C		145	200	mV
			$2.5V \leq V_{OUT(NOM)} < 3.3V$	+25°C		100	130	
			$3.3V \leq V_{OUT(NOM)} < 4.2V$	+25°C		85	110	
			$4.2V \leq V_{OUT(NOM)} < 5.2V$	+25°C		75	100	
	$V_{DROP}$	$I_{OUT} = 100mA$ , UTDFN-1×1-4AL	$1.8V \leq V_{OUT(NOM)} < 2.5V$	+25°C		130	175	mV
			$2.5V \leq V_{OUT(NOM)} < 3.3V$	+25°C		82	110	
			$3.3V \leq V_{OUT(NOM)} < 4.2V$	+25°C		70	90	
			$4.2V \leq V_{OUT(NOM)} < 5.2V$	+25°C		60	80	
Line Regulation	$\frac{\Delta V_{OUT}}{\Delta V_{IN} \times V_{OUT}}$	$V_{IN} = (V_{OUT(NOM)} + 1V)$ to 7.5V	+25°C		0.002	0.1	%/V	
Load Regulation	$\Delta V_{OUT}$	$I_{OUT} = 0.1mA$ to 250mA	+25°C		3	15	mV	
Short Current Limit	$I_{SHORT}$	$V_{OUT} = 0V$	+25°C		100		mA	
Reverse Leakage Current <sup>(2)</sup>	$I_{RL}$	$V_{IN} = 1.7V$ , $V_{OUT} = 5.5V$	+25°C		0.4		µA	
Power Supply Rejection Ratio	PSRR	$I_{OUT} = 30mA$ , $V_{OUT(NOM)} = 1.8V$ , $\Delta V_{RIPPLE} = 0.2V_{P-P}$	f = 217Hz	+25°C		38	dB	
			f = 1kHz	+25°C		27		
Output Voltage Temperature Coefficient <sup>(3)</sup>	$\frac{\Delta V_{OUT}}{\Delta T_J \times V_{OUT}}$		Full		10		ppm/°C	
<b>Shutdown</b>								
EN Input Threshold	$V_{IH}$	$V_{IN} = 1.7V$ to 7.5V	Full	1.4			V	
	$V_{IL}$		Full			0.4		
EN Input Bias Current	$I_{BH}$	$V_{EN} = 5.5V$	Full		25	500	nA	
	$I_{BL}$	$V_{EN} = 0V$	Full	-500		500		
Shutdown Supply Current	$I_{SHDN}$	$V_{EN} = 0V$	Full		0.75	1.3	µA	
Output Discharge Resistance	$R_{DIS}$	$V_{EN} = 0V$ , $V_{OUT} = 0.5V$	+25°C		60		Ω	
Thermal Shutdown Temperature	$T_{SHDN}$				165		°C	
Thermal Shutdown Hysteresis	$\Delta T_{SHDN}$				30		°C	

## NOTES:

- The dropout voltage is defined as the difference between  $V_{IN}$  and  $V_{OUT}$  when  $V_{OUT}$  falls to  $95\% \times V_{OUT(NOM)}$ .
- Reverse leakage current is the current flows from the output to the input when  $V_{OUT} > V_{IN}$ .
- Output voltage temperature coefficient is defined as the worst-case voltage change divided by the total temperature range.

TYPICAL PERFORMANCE CHARACTERISTICS

$T_J = +25^\circ\text{C}$ ,  $V_{IN} = V_{OUT(NOM)} + 1\text{V}$ ,  $V_{EN} = 5\text{V}$ ,  $C_{IN} = 1\mu\text{F}$  and  $C_{OUT} = 0.22\mu\text{F}$ , unless otherwise noted.

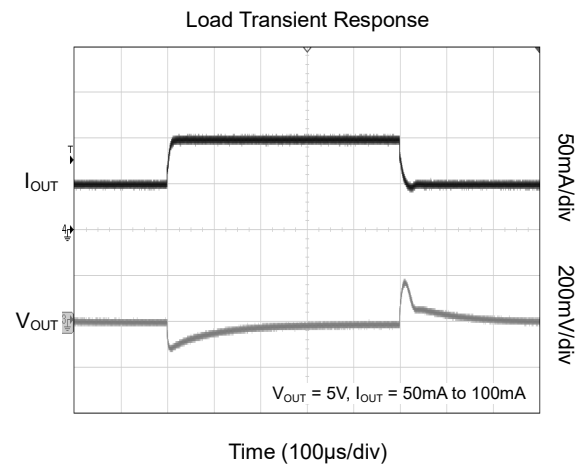
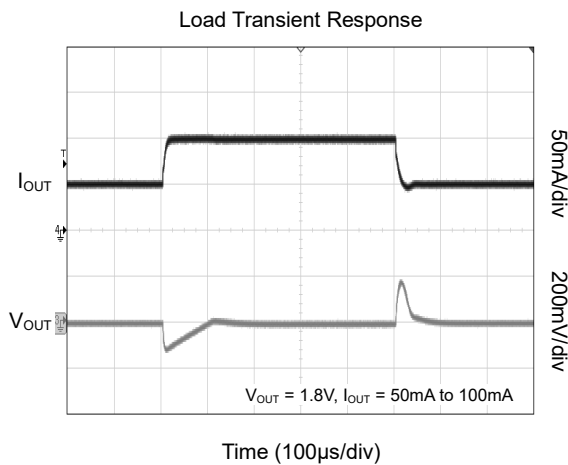
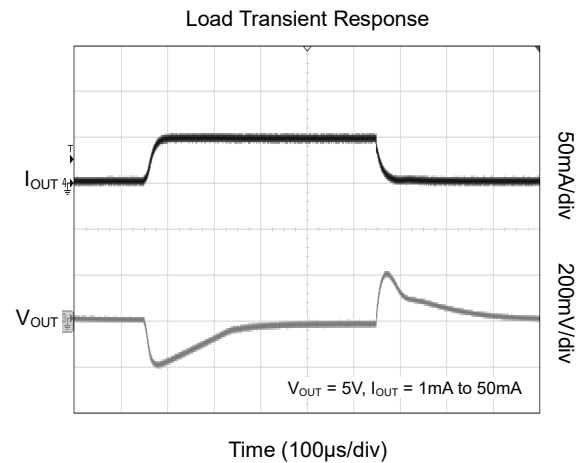
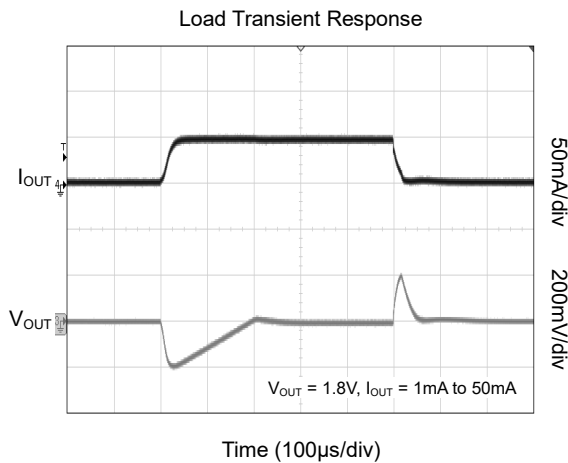
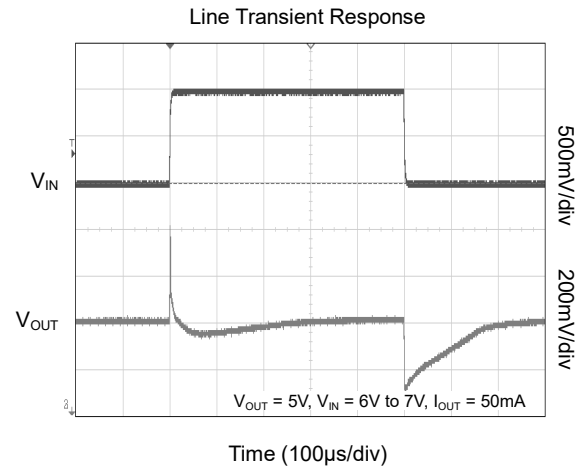
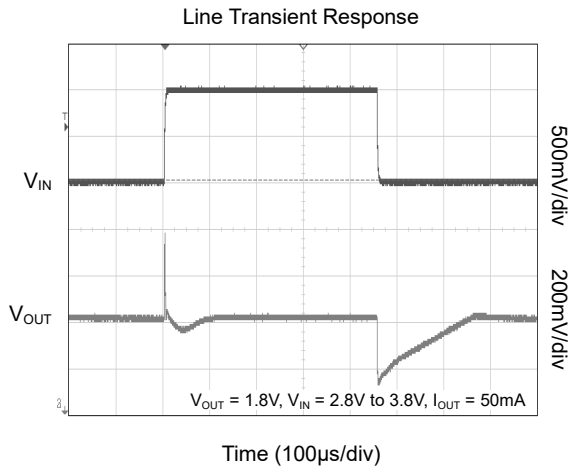

TYPICAL PERFORMANCE CHARACTERISTICS (continued)

T<sub>J</sub> = +25°C, V<sub>IN</sub> = V<sub>OUT(NOM)</sub> + 1V, V<sub>EN</sub> = 5V, C<sub>IN</sub> = 1µF and C<sub>OUT</sub> = 0.22µF, unless otherwise noted.

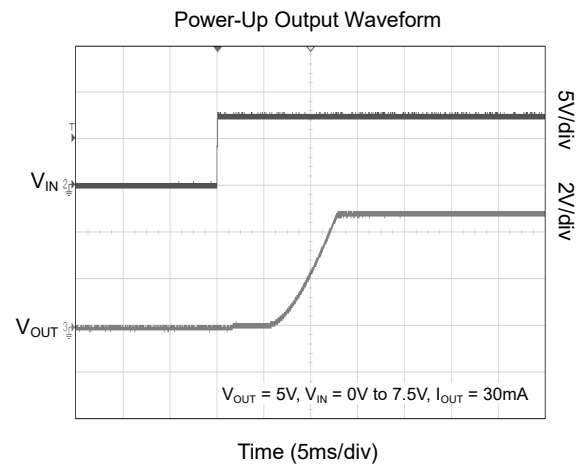
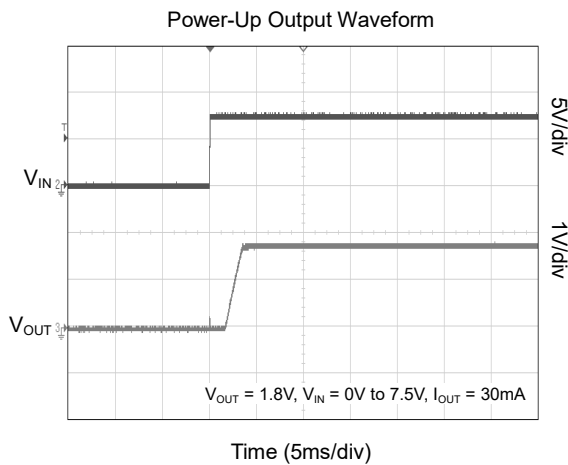
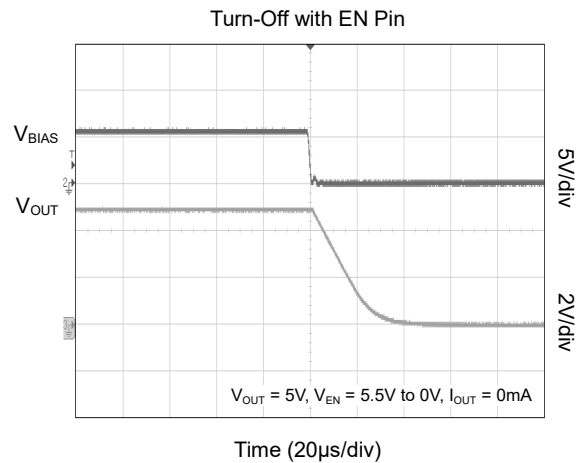
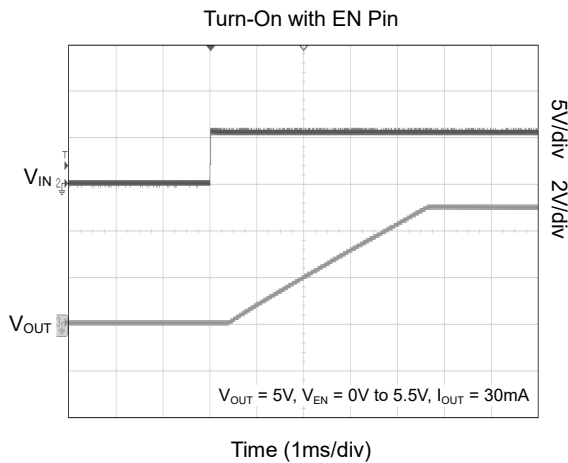
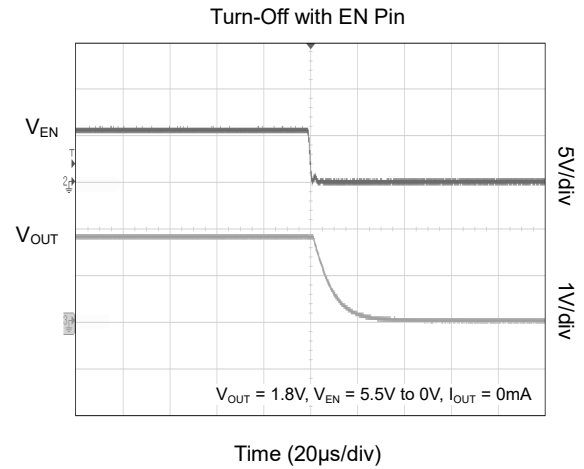
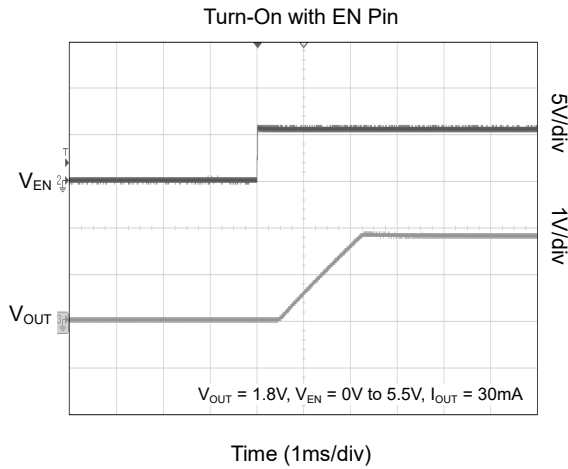

TYPICAL PERFORMANCE CHARACTERISTICS (continued)

$T_J = +25^\circ\text{C}$ ,  $V_{IN} = V_{OUT(NOM)} + 1\text{V}$ ,  $V_{EN} = 5\text{V}$ ,  $C_{IN} = 1\mu\text{F}$  and  $C_{OUT} = 0.22\mu\text{F}$ , unless otherwise noted.

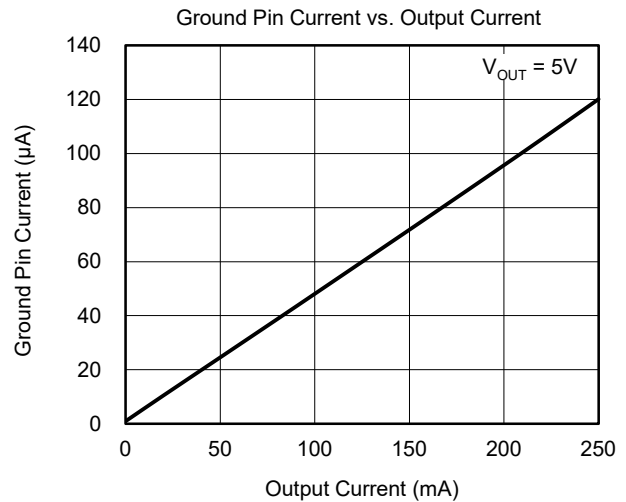
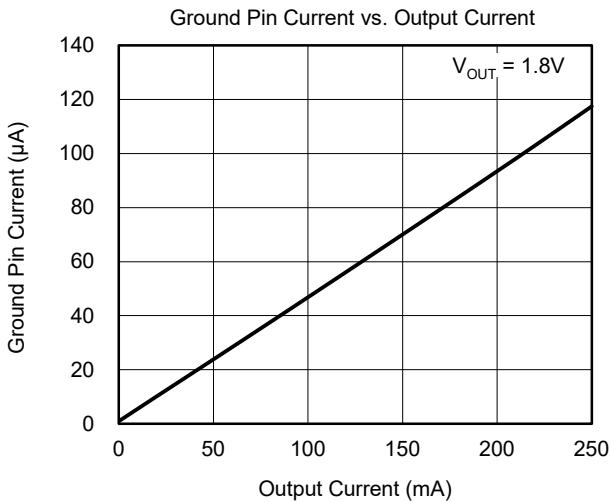
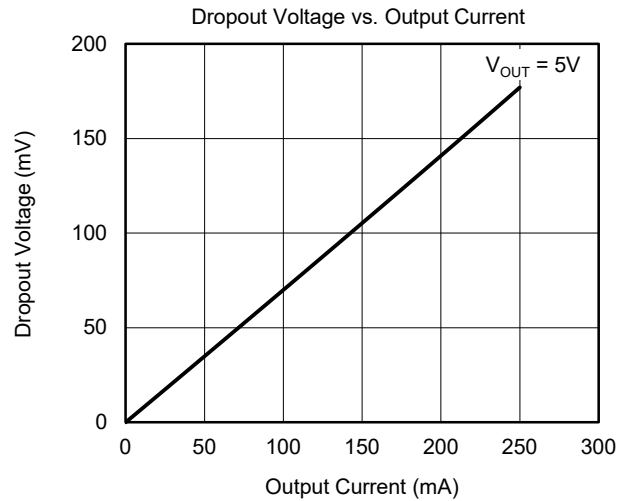
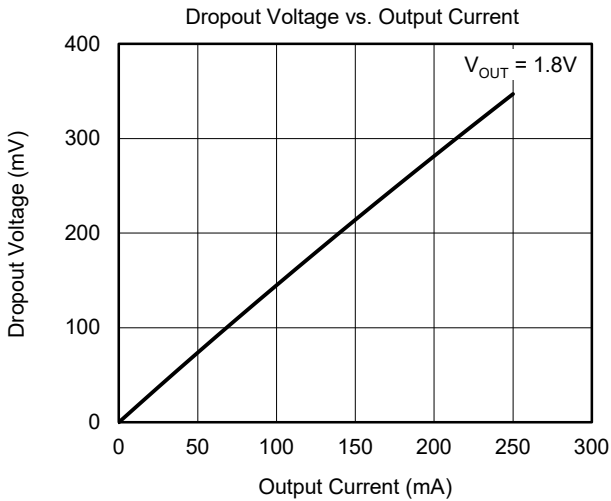
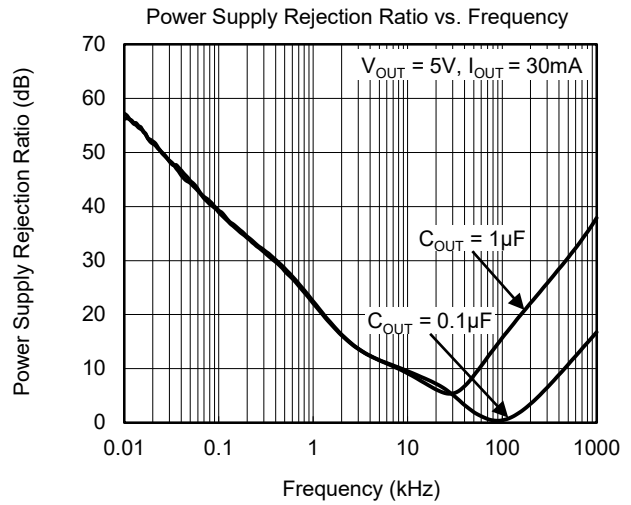
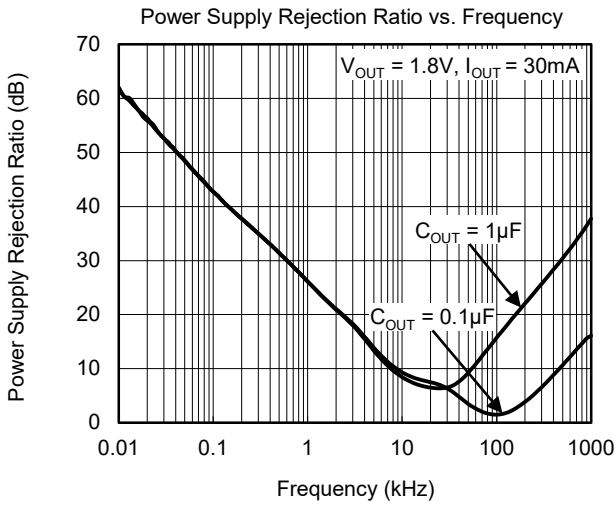



TYPICAL PERFORMANCE CHARACTERISTICS (continued)

$T_J = +25^\circ\text{C}$ ,  $V_{IN} = V_{OUT(NOM)} + 1\text{V}$ ,  $V_{EN} = 5\text{V}$ ,  $C_{IN} = 1\mu\text{F}$  and  $C_{OUT} = 0.22\mu\text{F}$ , unless otherwise noted.

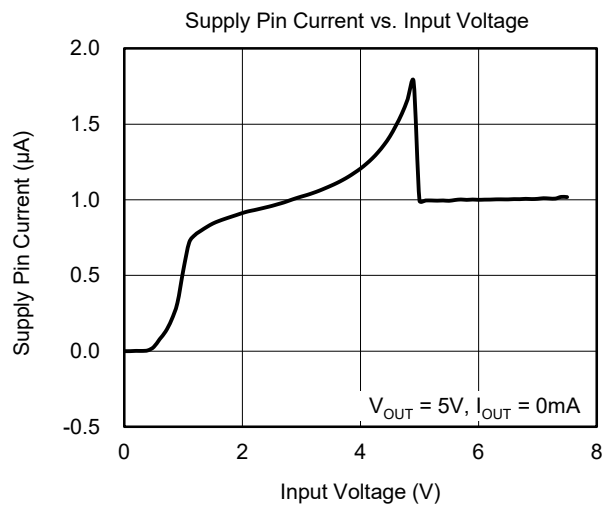
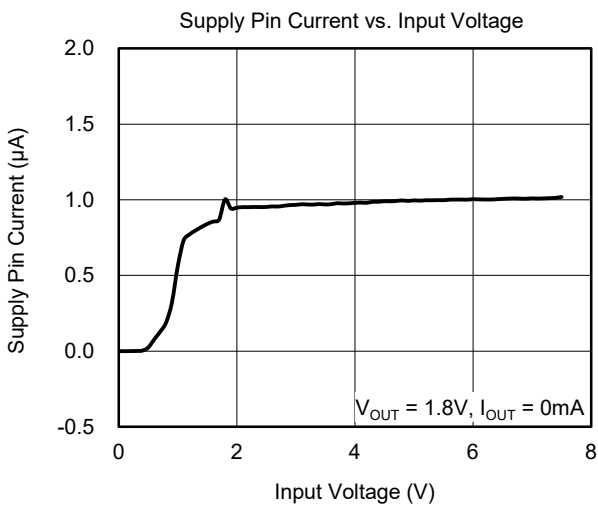
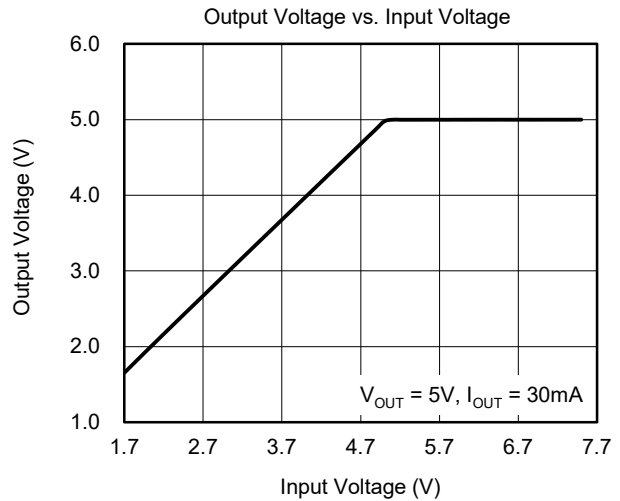
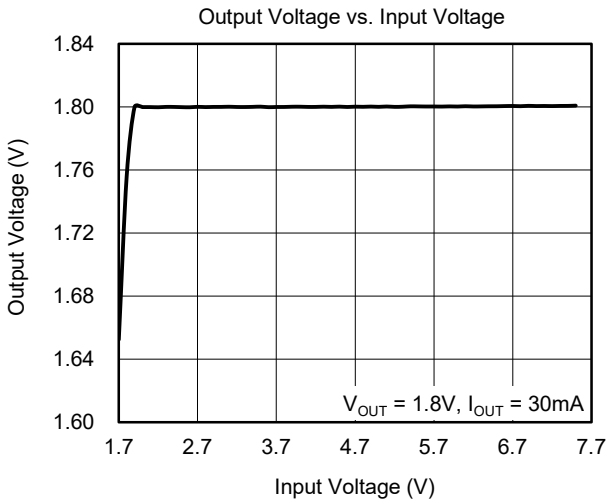
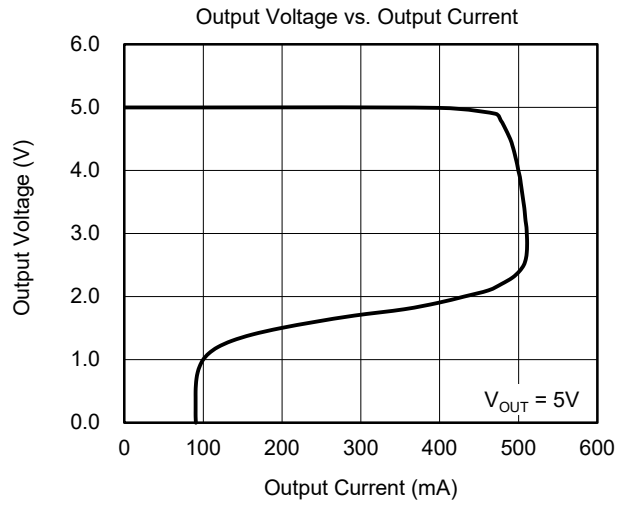
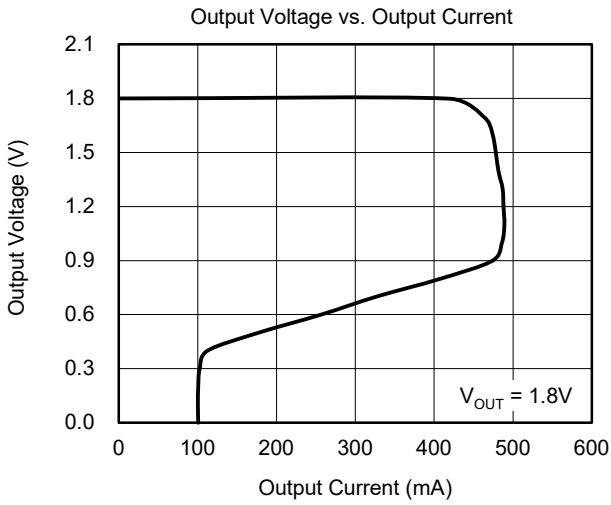

TYPICAL PERFORMANCE CHARACTERISTICS (continued)

$T_J = +25^\circ\text{C}$ ,  $V_{IN} = V_{OUT(NOM)} + 1\text{V}$ ,  $V_{EN} = 5\text{V}$ ,  $C_{IN} = 1\mu\text{F}$  and  $C_{OUT} = 0.22\mu\text{F}$ , unless otherwise noted.

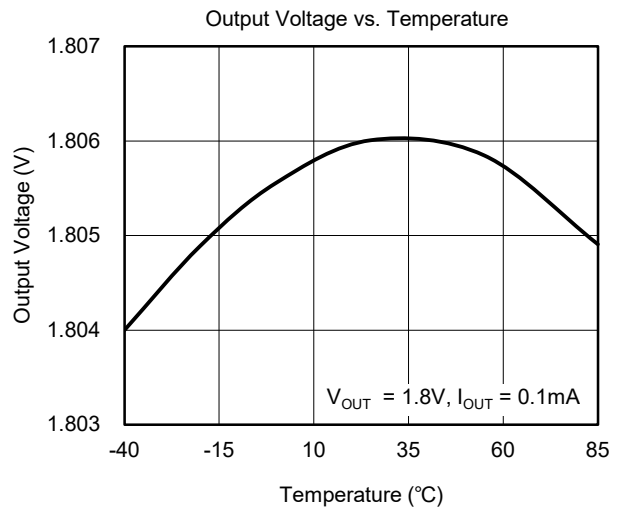
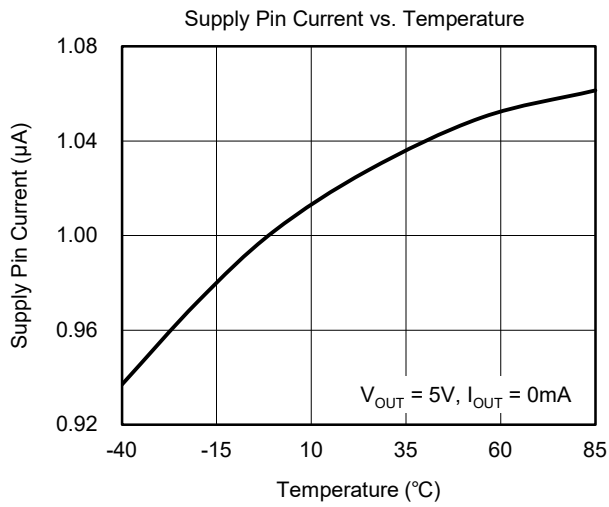

FUNCTIONAL BLOCK DIAGRAM

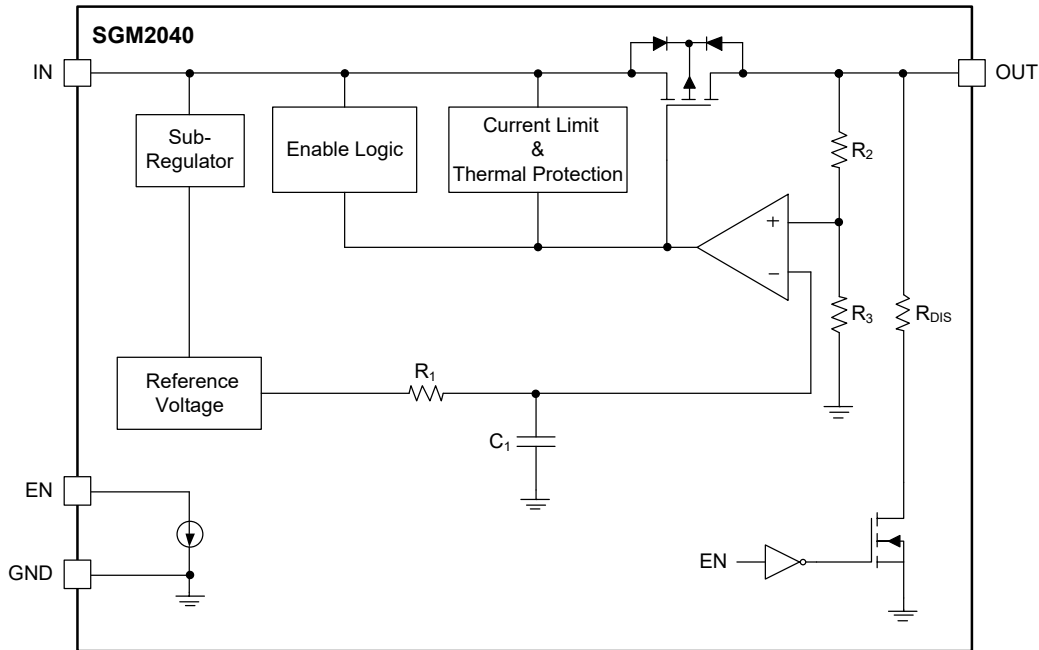

Figure 2. Block Diagram

APPLICATION INFORMATION

Input Capacitor Selection (C<sub>IN</sub>)

The input decoupling capacitor is necessary to be connected as close as possible to the IN pin for ensuring the device stability. 1µF or larger X7R or X5R ceramic capacitor is selected to get good dynamic performance.

When V<sub>IN</sub> is required to provide large current instantaneously, a large effective input capacitor is required. Multiple input capacitors can limit the input tracking inductance. Adding more input capacitors is available to restrict the ringing and to keep it below the device absolute maximum ratings.

Output Capacitor Selection (C<sub>OUT</sub>)

The output capacitor should be located as close as possible to the OUT pin. 0.22µF or larger X7R or X5R ceramic capacitor is selected to get good dynamic performance. The minimum effective capacitance of C<sub>OUT</sub> that SGM2040 can remain stable is 0.1µF. For ceramic capacitor, temperature, DC bias and package size will change the effective capacitance, so enough margin of C<sub>OUT</sub> must be considered in design. Additionally, C<sub>OUT</sub> with larger capacitance and lower

ESR will help increase the high frequency PSRR and improve the load transient response.

Output Current Limit and Short-Circuit Protection

When overload events happen, the output current is internally limited to 480mA (TYP). When the OUT pin is shorted to ground, the short-circuit protection will limit the output current to 100mA (TYP).

Reverse Current Protection

The SGM2040 incorporates reverse current protection circuit that prevents current flow backwards through the pass element when the output voltage is greater than the input voltage. A comparator senses the difference between the input and output voltages. When the difference between the output voltage and input voltage exceeds 800mV (TYP), the gate of the PFET is switched to V<sub>OUT</sub> and the PFET is turned off. Otherwise, the gate voltage of the PFET is unfixd, and the reverse current may be (V<sub>OUT</sub> - V<sub>IN</sub>) / R<sub>ON</sub>, R<sub>ON</sub> = V<sub>DROP</sub> / I<sub>OUT</sub>.

**REVISION HISTORY**

NOTE: Page numbers for previous revisions may differ from page numbers in the current version.

	<b>Page</b>
<b>JULY 2024 – REV.A.4 to REV.B</b>	
Updated Electrical Characteristics section .....	5
Updated Typical Performance Characteristics section .....	6
<b>AUGUST 2023 – REV.A.3 to REV.A.4</b>	
Updated Package Outline Dimensions .....	13
<b>NOVEMBER 2022 – REV.A.2 to REV.A.3</b>	
Updated Package Outline Dimensions .....	14
<b>NOVEMBER 2020 – REV.A.1 to REV.A.2</b>	
Updated Application Information section .....	10
<b>JUNE 2020 – REV.A to REV.A.1</b>	
Updated Absolute Maximum Ratings section .....	3
<b>Changes from Original (DECEMBER 2018) to REV.A</b>	
Changed from product preview to production data .....	All

# PACKAGE INFORMATION

## PACKAGE OUTLINE DIMENSIONS

### SOT-23-5

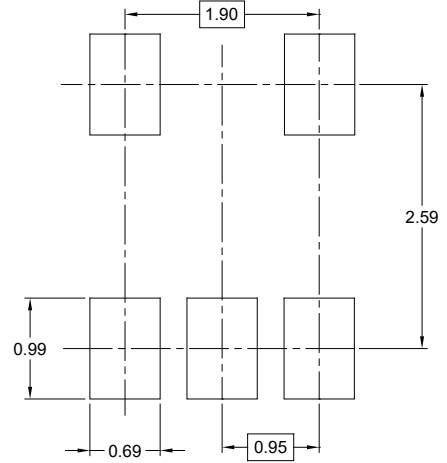
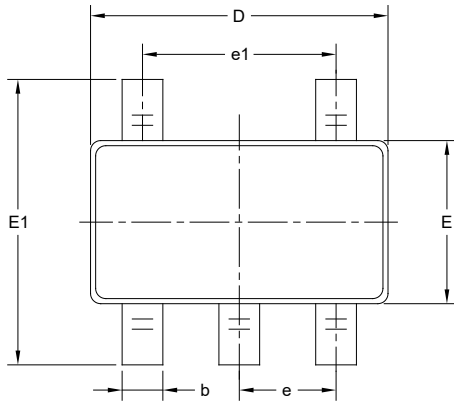

RECOMMENDED LAND PATTERN (Unit: mm)

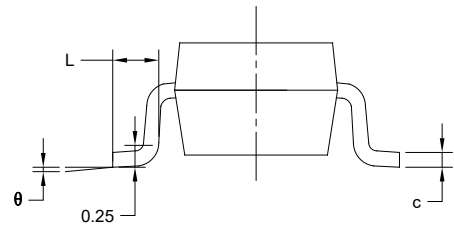
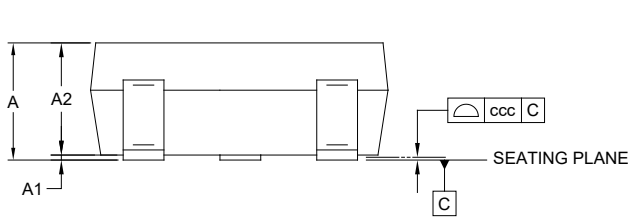

Symbol	Dimensions In Millimeters		
	MIN	MOD	MAX
A	-	-	1.450
A1	0.000	-	0.150
A2	0.900	-	1.300
b	0.300	-	0.500
c	0.080	-	0.220
D	2.750	-	3.050
E	1.450	-	1.750
E1	2.600	-	3.000
e	0.950 BSC		
e1	1.900 BSC		
L	0.300	-	0.600
$\theta$	0°	-	8°
ccc	0.100		

NOTES:

1. This drawing is subject to change without notice.
2. The dimensions do not include mold flashes, protrusions or gate burrs.
3. Reference JEDEC MO-178.

PACKAGE OUTLINE DIMENSIONS

UTDFN-1×1-4AL

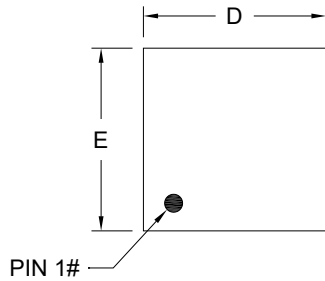

TOP VIEW

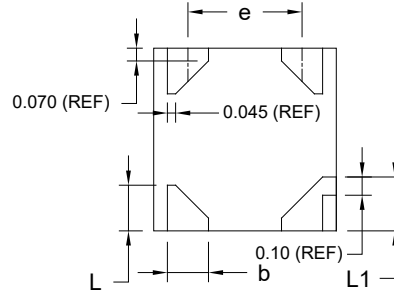

BOTTOM VIEW

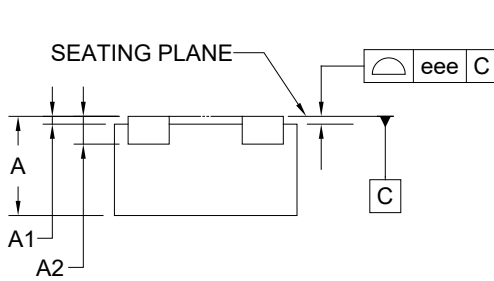

SIDE VIEW

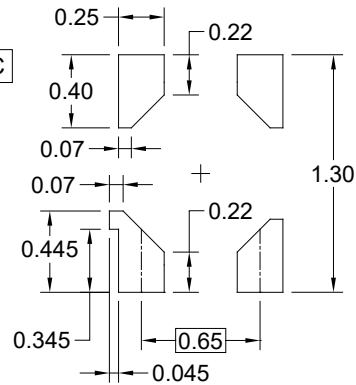

RECOMMENDED LAND PATTERN (Unit: mm)

Symbol	Dimensions In Millimeters		
	MIN	MOD	MAX
A	0.500	0.550	0.600
A1	0.000	-	0.050
A2	0.152 REF		
e	0.625 BSC		
D	0.950	1.000	1.050
E	0.950	1.000	1.050
b	0.175	0.225	0.275
L	0.200	0.250	0.300
L1	0.245	0.295	0.345
eee	0.050		

NOTE: This drawing is subject to change without notice.

## TAPE AND REEL INFORMATION

### REEL DIMENSIONS



### TAPE DIMENSIONS



NOTE: The picture is only for reference. Please make the object as the standard.

### KEY PARAMETER LIST OF TAPE AND REEL

Package Type	Reel Diameter	Reel Width W1 (mm)	A0 (mm)	B0 (mm)	K0 (mm)	P0 (mm)	P1 (mm)	P2 (mm)	W (mm)	Pin1 Quadrant
SOT-23-5	7"	9.5	3.20	3.20	1.40	4.0	4.0	2.0	8.0	Q3
UTDFN-1×1-4AL	7"	9.0	1.18	1.18	0.68	4.0	2.0	2.0	8.0	Q1

DD0001

# PACKAGE INFORMATION

## CARTON BOX DIMENSIONS



NOTE: The picture is only for reference. Please make the object as the standard.

## KEY PARAMETER LIST OF CARTON BOX

Reel Type	Length (mm)	Width (mm)	Height (mm)	Pizza/Carton
7" (Option)	368	227	224	8
7"	442	410	224	18

DD0002