

SBS[®] X-75A



Dust- Water- Shock

Sealed Connector

- Industrial / Commercial • Power Equipment • Material Handling / Automation
- Agricultural / Construction • Lawn / Garden Equipment • Marine



APP
Anderson Power Products[®]

An IDEAL Company

SBS®X-75A

The SBS®X-75A sealed waterproof connectors come with (2) power contacts rated up to 135A, along with up to (4) auxiliaries rated to 10A offering durability of up to 5,000 mating cycles. Positive metal latches help safeguard against accidental disconnects that may be caused by vibration, while the built-in cable clamp allows for strain relief on wires.

The compact sleek high-power design of these environmentally rugged connectors makes them ideal for outdoor applications. The IP68 weatherproof rating ensures that the connector will be free of water for full protection up to 30 minutes at 6 feet in the mated conditions, or with the use of covers in unmated condition.



600 Volts / 135A
(with Signals)



5,000 Mating Cycles



Operating Temperature
-20°C to 105°C / -4 °F to 221°F



Dust - Water - Shock

SPECIFICATIONS

ELECTRICAL

Current Rating Amperes ¹

| Wire to Wire | | No Signals | | Signals Energized | |
|--------------|-----------------|------------|-----|-------------------|-----|
| AWG | mm ² | UL | CSA | UL | CSA |
| 4 AWG | 25 | 140 | 85 | 135 | 80 |
| 6 AWG | 16 | 100 | 65 | 95 | 60 |
| 8 AWG | 10 | 95 | 58 | 93 | 53 |
| 10 AWG | 6 | 75 | 45 | 75 | 45 |

Wire Plug to Panel Mount Receptacle

| | | | | |
|----------------------------------|-----|----|-----|----|
| 4 AWG (25 mm ²) Wire | 145 | 90 | 140 | 85 |
|----------------------------------|-----|----|-----|----|

Panel Mount Plug to Panel Mount Receptacle

| | | | | |
|----------------------------------|-----|----|-----|----|
| 4 AWG (25 mm ²) Wire | 140 | 85 | 135 | 80 |
|----------------------------------|-----|----|-----|----|

Voltage Rating AC/DC

| | |
|---------|------|
| UL 1977 | 600V |
|---------|------|

Dielectric Withstanding Voltage

| | |
|----------|-------|
| Volts AC | 2,200 |
|----------|-------|

Average Mated Contact Resistance Milliohms ¹

| | |
|---|---------|
| Power 1/4 in. of 4 AWG (25 mm ²) Wire | 0.16m Ω |
| Auxiliary 14 AWG (1.0 to 1.5 mm ²) Wire | 2.50m Ω |

UL Hot Plug Current Rating Amperes

| | |
|----------------------------------|-----------------------|
| 4 AWG (25 mm ²) Wire | 250 cycles at 120V DC |
| | 50A |

Touch Safe

Per UL 60950-1, UL 62368-1 & IEC 60529³

MECHANICAL

| | | |
|--|---|----------------------|
| Wire Size Range | | |
| Power Contacts | 10 to 4 AWG (2.5 to 25.0 mm ²) | |
| Auxiliary Contacts | 14 to 24 AWG (0.50 to 1.5 mm ²) | |
| Maximum Wire Insulation Diameter | | |
| Power | 0.44 AWG (11.18 mm ²) | |
| Auxiliary | 0.44 AWG (11.18 mm ²) | |
| Operating Temperature ² | -20° to 105°C (-4 to 221°F) | |
| Mating Cycles No Load by Plating | 5,000 | |
| Average Mating / Unmating Force | | |
| Wire | 4 AWG (25 mm ²) | |
| Lbs / Kg | 6.5 Lbs (2.95 Kg) | |
| Minimum Creepage / Clearance Distance | | |
| | Creepage | Clearance |
| Power to Power | 1.50 in. (38.1 mm) | 0.900 in. (22.86 mm) |
| Power to Signal | 1.12 in. (28.4 mm) | 0.640 in. (16.26 mm) |
| Pin to Pin | 0.097 in. (2.46 mm) | 0.097 in. (2.46 mm) |
| Socket to Socket | 0.352 in. (8.94 mm) | 0.352 in. (8.94 mm) |
| Pin to Socket | 1.15 in. (29.21 mm) | 0.485 in. (12.3 mm) |
| Pull Out Force with Cable Clamp | 60 lb. | |
| Retention Force Auxiliary Housing | 35 lb. | |
| Drop Test | Per UL 486A-486B | |
| IP68 | Per UL50E ⁴ | |

MATERIALS

| | |
|--------------------------------------|----------------------------------|
| Housing, Cable Clamps, Covers | PC/PBT |
| Signal Housing | PC |
| Latches, Spring, Screws | Stainless Steel |
| O-Rings, Grommets | Silicone |
| Panel Mount Gasket | NBR |
| Housing Flammability Rating | UL94 V0 |
| Glow Wire (1.0 mm) | 960°C per 60695-2-12 |
| Wire Power Contact | Silver Plated Copper Alloy |
| SBS® 75X Auxiliary Contacts | |
| Pin | Copper Alloy, Au over Ni |
| Socket | Be Cu, Au over Ni |
| Socket Body | Copper Alloy, Tin Bright over Ni |
| Retention Clip | Stainless Steel |

NOTES:

- 1 - Current amperage ratings are based on 105°C rated or better cable of the largest wire size using properly calibrated APP® recommended tooling, and a 25°C ambient temperature, or CSA rating below a 30°C temperature rise. UL rating not to exceed the maximum operating temperature. Connector to be assembled and installed according to the manufacturer's instructions.
- 2 - Operating Temperatures are limited by the thermal properties of the connector's plastic housing.
- 3 - Sealed Connector Series offers protection against electric shock for finger safety both in mated and unmated condition. The Sealed SBS®X-75A Connector Series was tested for IP Code 1X-2X per clause 12- & 13 of IEC 60529, Edition 2.2, issued 2013-8 + Corr. 1:2013-10 + Corr. 2:2015-01. The connector was tested for IP1X and IP2 in mated and unmated condition, which is representative of protection against access to energized parts contained in UL 60950-1 2nd Edition, 2011-12-19 and UL 62368-1 3rd Edition, 2021-10-22.
- 4 - The Sealed SBS®X-75A Connector Series was subjected to submersion test, covered by UL 50E Standard for Enclosures for Electrical Equipment Environmental Considerations, 3rd Edition, with a pressure equivalent to 6 feet of water and for a duration of 30 minutes for the equivalent IP68 compliance. Note panel mount-to-panel mount configuration has not been tested for ingress protection rating; contact manufacturer to determine if it will work for your application.

TEMPERATURE CHARTS

SBS®X-75A Primary Contacts Only
Temperature Rise at Constant Current

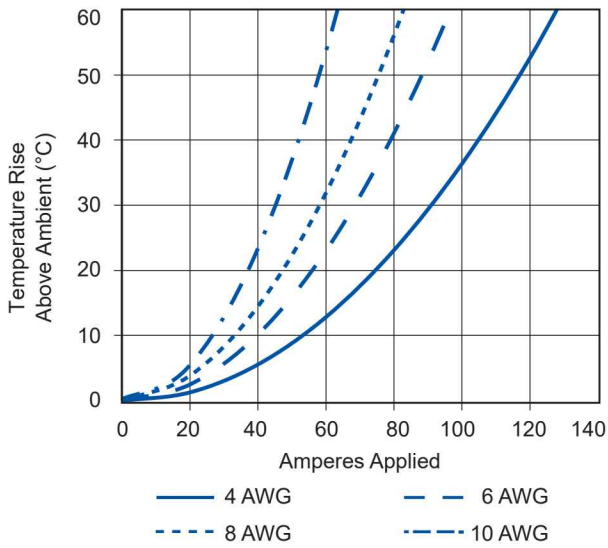

SBS®X-75A Primary Contacts Only
Derating vs. Ambient Temperature

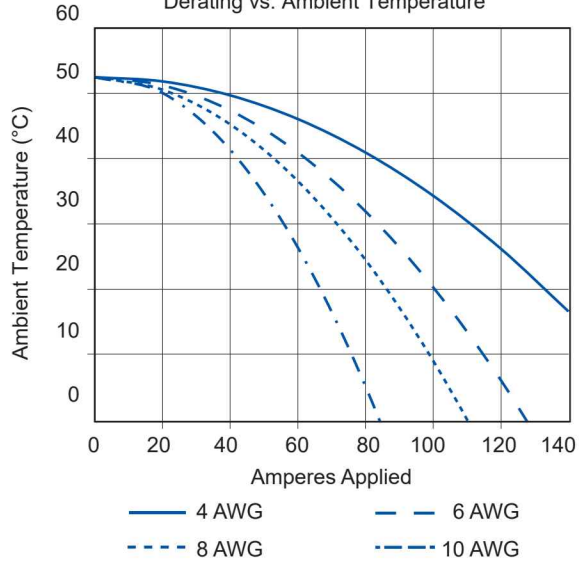

SBS®X-75A Auxiliary Contacts at 10A
Temperature Rise at Constant Current

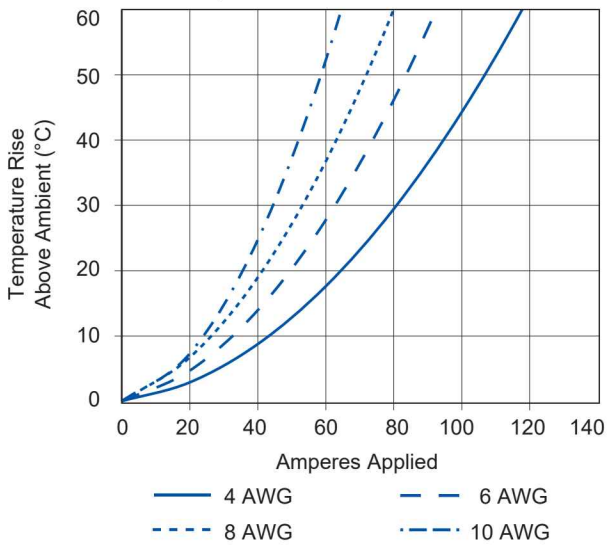

SBS®X-75A Auxiliary Contacts at 10A
Derating vs. Ambient Temperature

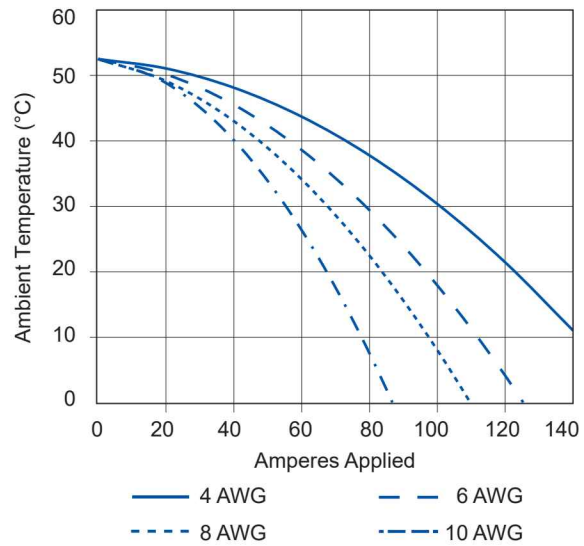

COMPONENTS

Wire-to-Wire

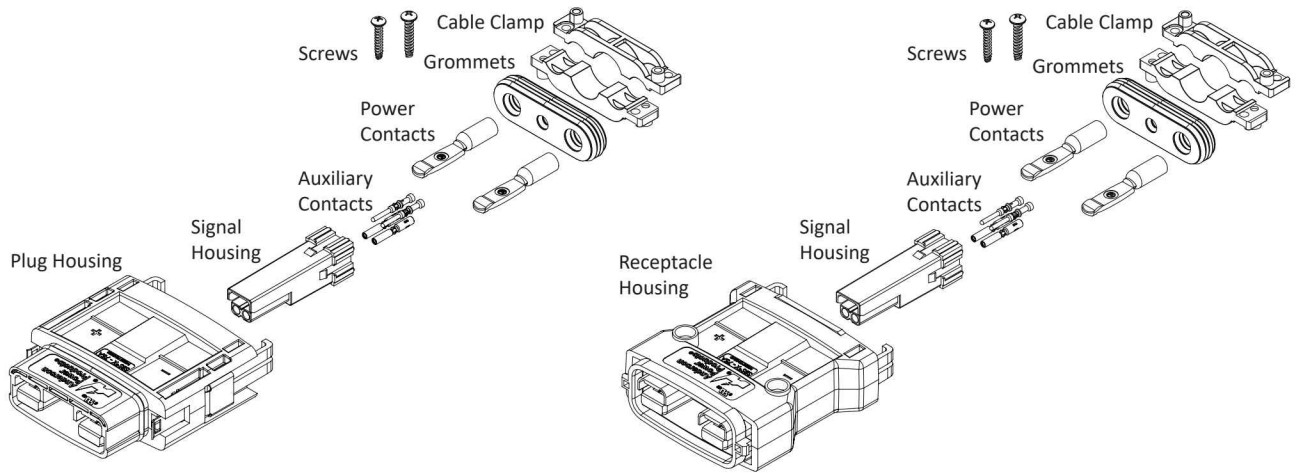

Wire-to-Panel Mount

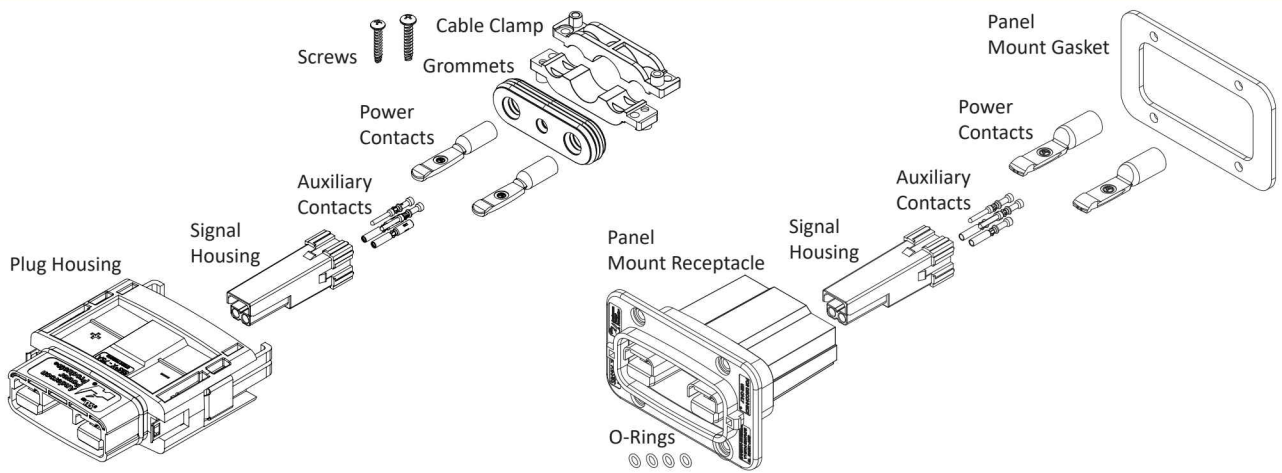



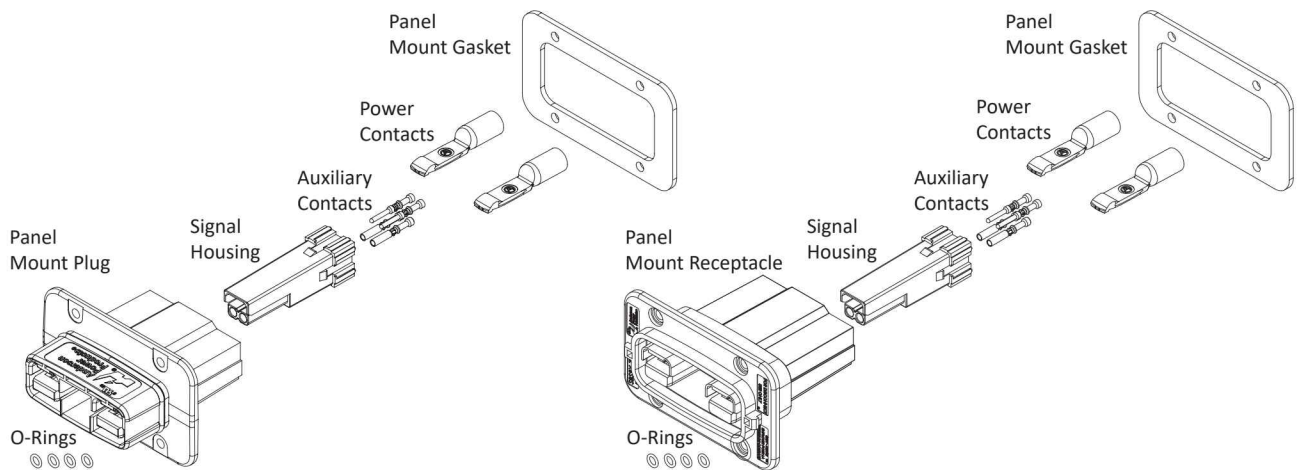

Panel Mount-to-Panel Mount







ORDERING INFORMATION - Color denotes signal housing only. All other housings are black.

Step 1: Select the Housing Kit - Packaged as Individual Kits. Contacts and Grommets Sold Separately, See Step 2 & 3

| Image | Part Number | Description- Sealed SBS®X-75A | Kit Includes- Housing, Signal Housing and Below Parts |
|---|------------------------|----------------------------------|---|
| | Minimum Quantity | | 1 |
|  | SBSX75A-PLUG-KIT-RED | Male Plug - Red | Latches, Cable Clamp, Hardware & Front O-Rings |
| | SBSX75A-PLUG-KIT-BLU | Male Plug - Blue | Latches, Cable Clamp, Hardware & Front O-Rings |
| | SBSX75A-PLUG-KIT-GRA | Male Plug - Gray | Latches, Cable Clamp, Hardware & Front O-Rings |
| | SBSX75A-PLUG-KIT-BLK | Male Plug - Black | Latches, Cable Clamp, Hardware & Front O-Rings |
|  | SBSX75A-REC-KIT-RED | Female Receptacle - Red | Cable Clamp, Hardware |
| | SBSX75A-REC-KIT-BLU | Female Receptacle - Blue | Cable Clamp, Hardware |
| | SBSX75A-REC-KIT-GRA | Female Receptacle - Gray | Cable Clamp, Hardware |
| | SBSX75A-REC-KIT-BLK | Female Receptacle - Black | Cable Clamp, Hardware |
|  | SBSX75A-PMREC-KIT-RED | Panel Mount Receptacle - Red * | Panel Gasket, Mounting O-Rings |
| | SBSX75A-PMREC-KIT-BLU | Panel Mount Receptacle - Blue * | Panel Gasket, Mounting O-Rings |
| | SBSX75A-PMREC-KIT-GRA | Panel Mount Receptacle - Gray * | Panel Gasket, Mounting O-Rings |
| | SBSX75A-PMREC-KIT-BLK | Panel Mount Receptacle - Black * | Panel Gasket, Mounting O-Rings |
|  | SBSX75A-PMPLUG-KIT-RED | Panel Mount Plug - Red * | Front O-Ring, Panel Gasket, Mounting O-Rings |
| | SBSX75A-PMPLUG-KIT-BLU | Panel Mount Plug - Blue * | Front O-Ring, Panel Gasket, Mounting O-Rings |
| | SBSX75A-PMPLUG-KIT-GRA | Panel Mount Plug - Gray * | Front O-Ring, Panel Gasket, Mounting O-Rings |
| | SBSX75A-PMPLUG-KIT-BLK | Panel Mount Plug - Black * | Front O-Ring, Panel Gasket, Mounting O-Rings |

Bulk Component Ordering Information - All components sold separately. For grommets and contacts, see step 2 & 3.



| Image | Part Number | Description- Sealed SBS®X-75A | Includes |
|---|--------------------|--------------------------------|----------------------------|
| | Minimum Quantity | | 100 |
|  | SBSX75A-PLUG-BLK | Male Plug Housing | Housing, Latches & O-Rings |
|  | SBSX75A-REC-BLK | Female Receptacle Housing | Housing |
|  | SBSX75A-PMREC-BLK | Panel Mount Receptacle Housing | Housing |
|  | SBSX75A-PMPLUG-BLK | Panel Mount Plug Housing * | Housing, Front O-Ring |

* Panel Mount Plug mates with Panel Mount Receptacle for Panel-to-Panel applications. Please note that this configuration has not been tested for Ingress protection ratings, please contact the manufacturer for further details on this requirement to see if it will work for your application needs. Panel Mount hardware not included.

Step 1 Continued - Bulk Components Continued

| | Minimum Quantity | | 200 |
|--|------------------|--|--------------------------------------|
|  | 2-8840P1 | Signal Housing - Red | Housing |
|  | 2-8840P2 | Signal Housing - Blue | Housing |
|  | 2-8840P3 | Signal Housing - Gray | Housing |
|  | 2-8840P4 | Signal Housing - Black | Housing |
|  | 2-8841P1 | Cable Clamp | Cable Clamp (set of two) |
|  | H1120P62 | #4 to 20 5/8" (15.88mm) Plastite Head Screws - Cable Clamp | Screws |
|  | 108G1 | Panel Mount Hardware Kit | Panel Mount Gasket, Mounting O-Rings |

Covers - Use When Parts are Unmated for IP68 Protection

| Image | Part Number | Description- Sealed SBS®X-75A | Includes |
|---|---------------------|-------------------------------|-----------------------------------|
| | Minimum Quantity | | 1 |
|  | SBSX75A-PLUG-COVER | Plug Cover * | Housing, Lanyard |
|  | SBSX75A-REC-COVER | Receptacle Cover | Housing, Latches, O-Ring, Lanyard |
|  | SBSX75A-PMREC-COVER | Panel Mount Receptacle Cover | Housing, Latches, O-Ring, Lanyard |

* Inquire with Manufacturer or Sales Representative regarding panel mount plug covers

Step 2: Grommets Sold Separately

To select proper grommet size, you will need to know the outer diameter of jacketed cable for each of the Power and Signal cables. Find your overall power size, then determine appropriate outer dimension for both Power and Signal cables. Not using signal, then select NS grommet that matches your power only size. Panel mount housings do not require grommets.

Discrete Wires



Discrete Wire
Power & Signal

| Part Number | Wire Size AWG | Wire Size mm ² | Power Wire Diameter Range (mm ²) | Signal Cable / Wire Size Diameter Range (mm ²) |
|-------------|---------------|---------------------------|--|--|
| D-150-060 | 10 to 12 | 2.5 to 6 | 0.15 to 0.18 (3.81 to 4.57) | 0.08 to 0.10 (2.03 to 2.54) |
| D-310-060 | 6 to 4 | 16 | 0.31 to 0.34 (7.87 to 8.64) | 0.08 to 0.10 (2.03 to 2.54) |

Jacket Cable



Jacket Cable
Power & Signal



Power Only

| Part Number | Wire Size AWG | Wire Size mm ² | Power Wire Diameter Range (mm ²) | Signal Cable / Wire Size Diameter Range (mm ²) |
|--------------------|---------------|---------------------------|--|--|
| Minimum Quantity 1 | | | | |
| J-150-150 | 10 to 12 | 2.5 to 6 | 0.15 to 0.18 (3.81 to 4.57) | 0.15 to 0.18 (3.81 to 4.57) |
| J-150-180 | 10 to 12 | 2.5 to 6 | 0.15 to 0.18 (3.81 to 4.57) | 0.18 to 0.21 (4.57 to 5.33) |
| J-150-320 | 10 to 12 | 2.5 to 6 | 0.15 to 0.18 (3.81 to 4.57) | 0.32 to 0.35 (8.13 to 8.89) |
| J-150-350 | 10 to 12 | 2.5 to 6 | 0.15 to 0.18 (3.81 to 4.57) | 0.35 to 0.38 (8.89 to 9.65) |
| J-150-380 | 10 to 12 | 2.5 to 6 | 0.15 to 0.18 (3.81 to 4.57) | 0.38 to 0.41 (9.65 to 10.41) |
| J-150-410 | 10 to 12 | 2.5 to 6 | 0.15 to 0.18 (3.81 to 4.57) | 0.41 to 0.44 (10.41 to 11.18) |
| NS-150 | 10 to 12 | 2.5 to 6 | 0.15 to 0.18 (3.81 to 4.57) | Power Cable |
| J-240-150 | 8 | 10 | 0.24 to 0.27 (6.10 to 6.86) | 0.15 to 0.18 (3.81 to 4.57) |
| J-240-180 | 8 | 10 | 0.24 to 0.27 (6.10 to 6.86) | 0.18 to 0.21 (4.57 to 5.33) |
| J-240-320 | 8 | 10 | 0.24 to 0.27 (6.10 to 6.86) | 0.32 to 0.35 (8.13 to 8.89) |
| J-240-350 | 8 | 10 | 0.24 to 0.27 (6.10 to 6.86) | 0.35 to 0.38 (8.89 to 9.65) |
| J-240-380 | 8 | 10 | 0.24 to 0.27 (6.10 to 6.86) | 0.38 to 0.41 (9.65 to 10.41) |
| J-240-410 | 8 | 10 | 0.24 to 0.27 (6.10 to 6.86) | 0.41 to 0.44 (10.41 to 11.18) |
| NS-240 | 8 | 10 | 0.24 to 0.27 (6.10 to 6.86) | No Signal |
| J-310-150 | 6 | 16 | 0.31 to 0.34 (7.87 to 8.64) | 0.15 to 0.18 (3.81 to 4.57) |
| J-310-180 | 6 | 16 | 0.31 to 0.34 (7.87 to 8.64) | 0.18 to 0.21 (4.57 to 5.33) |
| J-310-320 | 6 | 16 | 0.31 to 0.34 (7.87 to 8.64) | 0.32 to 0.35 (8.13 to 8.89) |
| J-310-350 | 6 | 16 | 0.31 to 0.34 (7.87 to 8.64) | 0.35 to 0.38 (8.89 to 9.65) |
| J-310-380 | 6 | 16 | 0.31 to 0.34 (7.87 to 8.64) | 0.38 to 0.41 (9.65 to 10.41) |
| J-310-410 | 6 | 16 | 0.31 to 0.34 (7.87 to 8.64) | 0.41 to 0.44 (10.41 to 11.18) |
| NS-310 | 6 | 16 | 0.31 to 0.34 (7.87 to 8.64) | No Signal |
| J-410-150 | 4 | 25 | 0.41 to 0.44 (10.41 to 11.18) | 0.15 to 0.18 (3.81 to 4.57) |
| J-410-180 | 4 | 25 | 0.41 to 0.44 (10.41 to 11.18) | 0.18 to 0.21 (4.57 to 5.33) |
| J-410-320 | 4 | 25 | 0.41 to 0.44 (10.41 to 11.18) | 0.32 to 0.35 (8.13 to 8.89) |
| J-410-350 | 4 | 25 | 0.41 to 0.44 (10.41 to 11.18) | 0.35 to 0.38 (8.89 to 9.65) |
| J-410-380 | 4 | 25 | 0.41 to 0.44 (10.41 to 11.18) | 0.38 to 0.41 (9.65 to 10.41) |
| J-410-410 | 4 | 25 | 0.41 to 0.44 (10.41 to 11.18) | 0.41 to 0.44 (10.41 to 11.18) |
| NS-410 | 4 | 25 | 0.41 to 0.44 (10.41 to 11.18) | No Signal |

NOTE: Don't see your cable size requirements? Speak to Manufacturer or your local Representative about other options regarding custom grommets.

Step 3: Contacts Sold Separately for Power and Signal

Silver Plated Primary Power Wire Contacts

SBS®X-75A housings use two silver plated contacts per housing for the best electrical performance and durability up to 10,000 mating cycles.

| Description | AWG | mm ² | Part Numbers- Loose Piece | | Diameter - A- | |
|------------------|----------|-----------------|---------------------------|----------|------------------|------|
| | | | | | inches | mm |
| Minimum Quantity | | | 1,000 | 100 | | |
| Standard | 4 | 25 | 1339G4-BK | 1339G4 * | 0.28 | 7.11 |
| | 6 | 16 | 1339G2-BK | 1339G2 * | 0.22 | 5.60 |
| | 8 | 10 | 1339G5-BK | 1339G5 * | 0.19 | 4.70 |
| | 12 to 10 | 2.5 to 6 | 1339G3-BK | 1339G3 * | 0.14 | 3.50 |

* Are sold as pairs. 2 contacts ship for every 1 ordered.

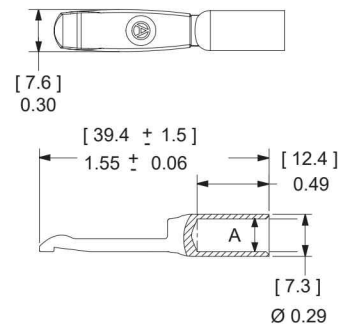

Pin Contacts for Auxiliary (4)

Gold plated contacts are available in 3 lengths to allow sequencing of circuits.

| Description | AWG | mm ² | Part Numbers |
|------------------------|----------|-----------------|--------------|
| Minimum Quantity | | | 500 |
| Standard Length 7.7 mm | 16 to 14 | 1.0 to 1.5 | PM16P1416S30 |
| | 20 to 16 | 0.75 to 1.0 | PM16P1620S30 |
| | 24 to 20 | 0.50 to 0.75 | PM16P2024S30 |
| Pre-Mate 9.3 mm | 16 to 14 | 1.0 to 1.5 | PM16P1416A30 |
| | 20 to 16 | 0.75 to 1.0 | PM16P1620A30 |
| | 24 to 20 | 0.50 to 0.75 | PM16P2024A30 |
| Post-Mate 6.4 mm | 16 to 14 | 1.0 to 1.5 | PM16P1416C30 |
| | 20 to 16 | 0.75 to 1.0 | PM16P1620C30 |
| | 24 to 20 | 0.50 to 0.75 | PM16P2024C30 |

Auxiliary Pin Contact Lengths

| | - L - | | - L1 - | |
|------------------------|-------|------|--------|-----|
| | in. | mm | in. | mm |
| Standard Length 7.7 mm | 0.77 | 19.6 | 0.30 | 7.7 |
| Pre-Mate 9.3 mm | 0.83 | 21.2 | 0.37 | 9.3 |
| Post-Mate 6.4 mm | 0.72 | 18.3 | 0.25 | 6.4 |

See drawings on website for further details.

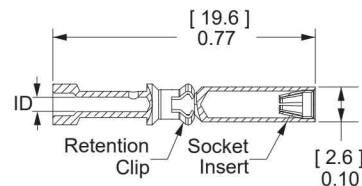

Socket Contacts for SBS®X-75A Auxiliary

Selective gold plated contacts offer low resistance and durability up to 10,000 mating cycles.

| Description | AWG | mm ² | Part Numbers | AWG | in. | mm. |
|------------------|----------|-----------------|--------------|----------|------|-----|
| Minimum Quantity | | | 500 | | | |
| Socket Contacts | 16 to 14 | 1.0 to 1.5 | PM16S1416S32 | 16 to 14 | 0.08 | 2.1 |
| | 20 to 16 | 0.75 to 1.0 | PM16S1620S32 | 20 to 16 | 0.07 | 1.7 |
| | 24 to 20 | 0.50 to 0.75 | PM16S2024S32 | 24 to 20 | 0.04 | 1.1 |

See drawings on website for further details.

Auxiliary Socket Contacts Crimp Barrel ID

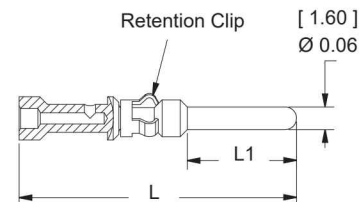

SBS® TOOLING INFORMATION ⁵

| Wire Size | | Power / Ground Contacts | | | | | | | | |
|-----------|-----------------|---------------------------|----------------------|--------|--------|---|---------|------------------|----|-----------|
| AWG | mm ² | Power Contact Part Number | Pneumatic Bench Tool | + | Die | + | Locator | Number of Crimps | OR | Hand Tool |
| 4 | 25.0 | 1339G4 | 1387G1 | | 1388G7 | | 1389G9 | Single | | N/A |
| 6 | 13.3 | 1339G2 | 1387G1 | | 1388G6 | | 1389G9 | Single | | 1309G4 |
| 8 | 8.4 | 1339G5 | | 1388G7 | | | | | | |
| 10 to 12 | 5.3 to 3.3 | 1339G3 | | | | | | | | |

| Wire Size | | Auxiliary Contacts | | | | | | | | |
|-----------|-----------------|-------------------------------------|------------------------------------|----|---|----|-----------------------------|------------------|---|------------------------------|
| AWG | mm ² | Auxiliary Contact Part Number | APP® Hand Tool w/ Integral Locator | OR | Mil Std. Hand Tool ⁶ M22520/1-01 | OR | Pneumatic Tool ⁶ | Number of Crimps | + | Locator for: TM0001 & TP0001 |
| 12 to 24 | 2.5 to 0.25 | All Crimp Pins All Crimp Sockets | PM1000G1 | | TM0001 | | TP0001 | Single | | TL0001 TL0002 |

Auxiliary Contact Insertion Tool: 111038G3

Auxiliary Contact Extraction Tool: PM1003G1

Auxiliary Contact Insertion Inspection Tool: PM1003GX

Single Housing Extraction Tool: 116081P1

Tools

1387G1
Other die locators
available per above



1309G4



PM1000G1



PM1003G1



PM1003GX



111038G3



116081P1⁷



NOTES:

- 5 - The use of APP® recommended tooling is strongly recommended. The use of alternate tools may adversely affect the performance of our connectors along with UL and CSA recognition.
- 6 - TP001 and TM0001 tools require locators TL001 for Pins and TL002 for Sockets. The Auxiliary contacts used with wire sizes 16 to 24 AWG (1.5 to 0.50) cannot be properly inserted without the insertion tool. Properly installed Auxiliary contacts of all wire gauges cannot be removed from the housing without the extraction tool. It is highly recommended that inspection tool be used to ensure the auxiliary contacts are seated properly in the housing.
- 7 - The Signal Housing Extraction Tool must be used in order to remove the signal housing from the main housing should position be inserted incorrectly for mating. See assembly instructions for further information.

BUILD YOUR PART NUMBER

Step 1

Housings (including signals)

Cable Clamp

Screw

Panel Mount Kit

Covers

Step 2

Grommets

Step 3

Power Contacts

Signal Contacts

Tooling

All Data Subject to Change Without Notice DS-SBSX75A REV 0 **Your Best Connection™**

Anderson™ will use reasonable efforts to include accurate and up-to-date content in the data sheet. All product information contained in the data sheet including ordering information, illustrations, specifications, and dimensions, are believed to be reliable as of the date of publishing, but is subject to change without notice. Anderson™ makes no warranty or representation as to its accuracy. Content in the data sheet may contain technical inaccuracies, typographical errors and may be changed or updated without notice. Anderson™ may also make improvements and/or changes to the products and/or to the programs described in the content at any time without notice. Current sales drawings and specifications are available upon request.

©2022 Anderson Power Products, Inc. All rights reserved. A®, APP®, SBS®, Anderson Power Products® and the APP logo are registered trademarks of Anderson Power Products, Inc. Anderson™ and Your Best Connection™ are trademarks of Anderson Power Products, Inc.



HEADQUARTERS: Anderson Power Products®, 13 Pratts Junction Road, Sterling, MA 01564-2305 USA T: +1 978-422-3800 F: +1 978-422-0128 • **EUROPE:** Anderson Power Products® Ltd., Unit 3, Europa Court, Europa Boulevard, Westbrook, Warrington, Cheshire, WA5 7TN United Kingdom T: +44 (0) 1925 428390 F: +44 (0) 1925 520203

• **GERMANY:** IDEAL® Industries Germany GmbH, Esslinger Strasse 7, D – 70771 Leinfelden-Echterdingen, T: +49 (0) 711 – 997606666 • **ASIA / PACIFIC:** IDEAL® Anderson Asia Pacific Ltd., Unit 922-928 Topsail Plaza, 11 On Sum Street, Shatin N.T., Hong Kong T: +(852) 2636 0836 F: +(852) 2635 9036 • **INDIA:** IDEAL® INDUSTRIES India Private Limited, 229-230, SPAZEDGE, Tower B, Sector 47, Sohna Road, Gurgaon – 122018, Haryana, India T: +(91) 956-0075905 T: +(91) 124-4495101 • **CHINA:** IDEAL® Anderson Technologies (Shenzhen) Ltd., Block A8 Tantou Western Industrial Park, Songgang Baoan District, Shenzhen, PR. China 518105 T: +(86) 755 2768 2118 F: +(86) 755 2768 2218

• www.ideal-industries.in • www.andersonpower.com