

### GENERAL DESCRIPTION

The SGM2211 is a low noise, high PSRR, fast transient response and low dropout voltage linear regulator. It provides 500mA output current capability. The operating input voltage range is from 2.7V to 20V. The adjustable output voltage range is from 1.2V to ( $V_{IN} - V_{DROP}$ ).

Other features include logic-controlled shutdown mode, short-circuit current limit and thermal shutdown protection. The SGM2211 has automatic discharge function to quickly discharge  $V_{OUT}$  in the disabled status.

The SGM2211 is available in Green TDFN-2x2-6AL and SOT-23-5 packages. It operates over an operating temperature range of -40°C to +125°C.

### APPLICATIONS

Instrumentation

Precision ADC and DAC

Precision Amplifiers in Industrial Equipment

Low Noise VCO

RF System

Medical Equipment

### FEATURES

- **Operating Input Voltage Range: 2.7V to 20V**
- **Fixed Output from 1.2V, 1.5V, 1.8V, 2.5V, 2.8V, 3.0V, 3.3V, 3.8V, 4.2V and 5.0V**
- **Adjustable Output from 1.2V to ( $V_{IN} - V_{DROP}$ ) (For TDFN Package, Output Voltage can be Adjusted above Initial Fixed Output Voltage)**
- **500mA Output Current**
- **Output Voltage Accuracy:  $\pm 1\%$  at +25°C**
- **Low Quiescent Current: 43 $\mu$ A (TYP)**
- **Low Dropout Voltage: 360mV (TYP) at 500mA,  $V_{OUT} = 5.0V$**
- **Low Noise:**
  - ◆ 9.3 $\mu$ V<sub>RMS</sub> at  $V_{OUT} = 1.2V$
  - ◆ 11 $\mu$ V<sub>RMS</sub> at  $V_{OUT} = 2.8V$
  - ◆ 14 $\mu$ V<sub>RMS</sub> at  $V_{OUT} = 5.0V$
- **High PSRR ( $V_{IN} = V_{OUT(NOM)} + 1V$ ):**
  - ◆ 100dB (TYP) at 1kHz
  - ◆ 83dB (TYP) at 10kHz
  - ◆ 52dB (TYP) at 100kHz
  - ◆ 55dB (TYP) at 1MHz
- **Current Limiting and Thermal Protection**
- **Excellent Load and Line Transient Responses**
- **With Output Automatic Discharge**
- **Stable with Small Case Size Ceramic Capacitors**
- **Programmable Soft-Start (TDFN Package Only)**
- **Shutdown Supply Current: 1.2 $\mu$ A (TYP)**
- **Reverse Current Protection when  $V_{OUT} > V_{IN}$**
- **Foldback Current-Limit Protection when  $V_{OUT}$  is Shorted to GND**
- **Programmable Precision Enable**
- **-40°C to +125°C Operating Temperature Range**
- **Available in Green TDFN-2x2-6AL and SOT-23-5 Packages**

**PACKAGE/ORDERING INFORMATION**

MODEL	PACKAGE DESCRIPTION	SPECIFIED TEMPERATURE RANGE	ORDERING NUMBER	PACKAGE MARKING	PACKING OPTION
SGM2211-1.2	TDFN-2x2-6AL	-40°C to +125°C	SGM2211-1.2XTDI6G/TR	C1B XXXX	Tape and Reel, 3000
SGM2211-1.5	TDFN-2x2-6AL	-40°C to +125°C	SGM2211-1.5XTDI6G/TR	C1C XXXX	Tape and Reel, 3000
SGM2211-1.8	TDFN-2x2-6AL	-40°C to +125°C	SGM2211-1.8XTDI6G/TR	C1D XXXX	Tape and Reel, 3000
SGM2211-2.5	TDFN-2x2-6AL	-40°C to +125°C	SGM2211-2.5XTDI6G/TR	C1E XXXX	Tape and Reel, 3000
SGM2211-2.8	TDFN-2x2-6AL	-40°C to +125°C	SGM2211-2.8XTDI6G/TR	C1F XXXX	Tape and Reel, 3000
SGM2211-3.0	TDFN-2x2-6AL	-40°C to +125°C	SGM2211-3.0XTDI6G/TR	C20 XXXX	Tape and Reel, 3000
SGM2211-3.3	TDFN-2x2-6AL	-40°C to +125°C	SGM2211-3.3XTDI6G/TR	C21 XXXX	Tape and Reel, 3000
SGM2211-3.8	TDFN-2x2-6AL	-40°C to +125°C	SGM2211-3.8XTDI6G/TR	C22 XXXX	Tape and Reel, 3000
SGM2211-4.2	TDFN-2x2-6AL	-40°C to +125°C	SGM2211-4.2XTDI6G/TR	C23 XXXX	Tape and Reel, 3000
SGM2211-5.0	TDFN-2x2-6AL	-40°C to +125°C	SGM2211-5.0XTDI6G/TR	C24 XXXX	Tape and Reel, 3000
SGM2211-1.2	SOT-23-5	-40°C to +125°C	SGM2211-1.2XN5G/TR	C11XX	Tape and Reel, 3000
SGM2211-1.5	SOT-23-5	-40°C to +125°C	SGM2211-1.5XN5G/TR	C12XX	Tape and Reel, 3000
SGM2211-1.8	SOT-23-5	-40°C to +125°C	SGM2211-1.8XN5G/TR	C13XX	Tape and Reel, 3000
SGM2211-2.5	SOT-23-5	-40°C to +125°C	SGM2211-2.5XN5G/TR	C14XX	Tape and Reel, 3000
SGM2211-2.8	SOT-23-5	-40°C to +125°C	SGM2211-2.8XN5G/TR	C15XX	Tape and Reel, 3000
SGM2211-3.0	SOT-23-5	-40°C to +125°C	SGM2211-3.0XN5G/TR	C16XX	Tape and Reel, 3000
SGM2211-3.3	SOT-23-5	-40°C to +125°C	SGM2211-3.3XN5G/TR	C17XX	Tape and Reel, 3000
SGM2211-3.8	SOT-23-5	-40°C to +125°C	SGM2211-3.8XN5G/TR	C18XX	Tape and Reel, 3000
SGM2211-4.2	SOT-23-5	-40°C to +125°C	SGM2211-4.2XN5G/TR	C19XX	Tape and Reel, 3000
SGM2211-5.0	SOT-23-5	-40°C to +125°C	SGM2211-5.0XN5G/TR	C1AXX	Tape and Reel, 3000
SGM2211-ADJ	SOT-23-5	-40°C to +125°C	SGM2211-ADJXN5G/TR	C2FXX	Tape and Reel, 3000

**MARKING INFORMATION**

NOTE: XX = Date Code. XXXX = Date Code and Trace Code.

**TDFN-2x2-6AL**

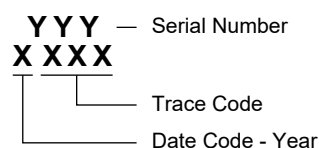

**SOT-23-5**

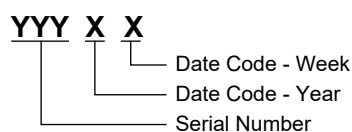

Green (RoHS & HSF): SG Micro Corp defines "Green" to mean Pb-Free (RoHS compatible) and free of halogen substances. If you have additional comments or questions, please contact your SGMICRO representative directly.

**ABSOLUTE MAXIMUM RATINGS**

VIN to GND	-0.3V to 24V
VOUT to GND	-0.3V to 24V
EN to GND	-0.3V to 24V
SENSE/ADJ to GND	-0.3V to 24V
SS to GND	-0.3V to VIN or 6V (whichever is less)
Package Thermal Resistance	
TDFN-2×2-6AL, $\theta_{JA}$	59.7°C/W
TDFN-2×2-6AL, $\theta_{JB}$	25.7°C/W
TDFN-2×2-6AL, $\theta_{JC(TOP)}$	78.1°C/W
TDFN-2×2-6AL, $\theta_{JC(BOT)}$	8°C/W
SOT-23-5, $\theta_{JA}$	144.7°C/W
SOT-23-5, $\theta_{JB}$	35.5°C/W
SOT-23-5, $\theta_{JC}$	53.4°C/W
Junction Temperature	+150°C
Storage Temperature Range	-65°C to +150°C
Lead Temperature (Soldering, 10s)	+260°C
ESD Susceptibility	
HBM	8000V
CDM	1000V

**RECOMMENDED OPERATING CONDITIONS**

Input Voltage Range	2.7V to 20V
Input Effective Capacitance, $C_{IN}$	1.5 $\mu$ F (MIN)
Output Effective Capacitance, $C_{OUT}$	1.5 $\mu$ F to 10 $\mu$ F
Operating Junction Temperature Range	-40°C to +125°C

**OVERSTRESS CAUTION**

Stresses beyond those listed in Absolute Maximum Ratings may cause permanent damage to the device. Exposure to absolute maximum rating conditions for extended periods may affect reliability. Functional operation of the device at any conditions beyond those indicated in the Recommended Operating Conditions section is not implied.

**ESD SENSITIVITY CAUTION**

This integrated circuit can be damaged if ESD protections are not considered carefully. SGMICRO recommends that all integrated circuits be handled with appropriate precautions. Failure to observe proper handling and installation procedures can cause damage. ESD damage can range from subtle performance degradation to complete device failure. Precision integrated circuits may be more susceptible to damage because even small parametric changes could cause the device not to meet the published specifications.

**DISCLAIMER**

SG Micro Corp reserves the right to make any change in circuit design, or specifications without prior notice.

PIN CONFIGURATIONS

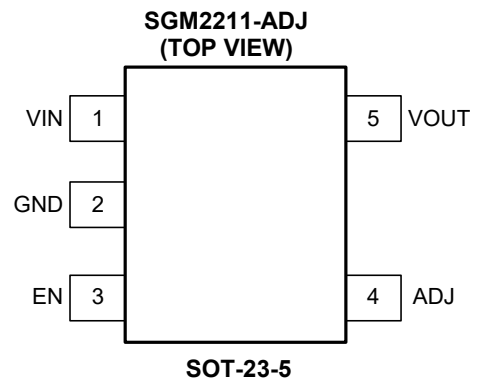
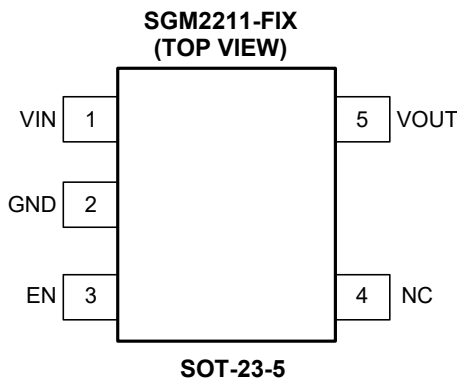
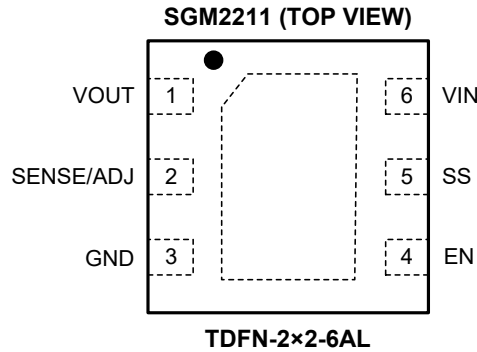

PIN DESCRIPTION

PIN		NAME	FUNCTION
TDFN-2x2-6AL	SOT-23-5		
1	5	VOUT	Regulator Output Pin. It is recommended to use a ceramic capacitor with effective capacitance in the range of 1.5μF to 10μF to ensure stability. This ceramic capacitor should be placed as close as possible to VOUT pin.
2	–	SENSE/ADJ	Sense Input (SENSE). Connect to load. An external resistor divider may also set the output voltage higher than the fixed output voltage (ADJ).
3	2	GND	Ground.
4	3	EN	Enable Pin. Drive EN high to turn on the regulator. Drive EN low to turn off the regulator.
5	–	SS	Soft-Start Pin. The soft-start time is determined by an external capacitor connected to this pin.
6	1	VIN	Input Voltage Supply Pin. It is recommended to use a ceramic capacitor with a minimum effective capacitance of 1.5μF from VIN pin to ground to get good power supply decoupling.
–	4	NC	No Connection (fixed voltage version only).
–		ADJ	Feedback Voltage Input Pin (adjustable voltage version only). Connect this pin to the midpoint of an external resistor divider to adjust the output voltage. Place the resistors as close as possible to this pin.
Exposed Pad	–	–	Exposed Pad. Connect it to a large ground plane to maximize thermal performance. This pad is not an electrical connection point.

## ELECTRICAL CHARACTERISTICS

( $V_{IN} = (V_{OUT(NOM)} + 1V)$  or 2.7V (whichever is greater),  $V_{EN} = V_{IN}$ ,  $I_{OUT} = 10mA$ ,  $C_{IN} = 2.2\mu F$ ,  $C_{OUT} = 2.2\mu F$  and  $C_{SS} = 0nF$ ,  $T_J = -40^\circ C$  to  $+125^\circ C$ , typical values are at  $T_J = +25^\circ C$ , unless otherwise noted.)

PARAMETER	SYMBOL	CONDITIONS	MIN	TYP	MAX	UNITS	
Input Voltage Range	$V_{IN}$		2.7		20	V	
Output Voltage Accuracy	$V_{OUT}$	$V_{IN} = (V_{OUT(NOM)} + 1V)$ to 20V, $I_{OUT} = 100\mu A$ to 500mA	$T_J = +25^\circ C$	-1	1	%	
			$T_J = -40^\circ C$ to $+125^\circ C$	-1.6	1.6		
Feedback Voltage	$V_{ADJ}$	$I_{OUT} = 10mA$ , $T_J = +25^\circ C$ $V_{IN} = (V_{OUT(NOM)} + 1V)$ to 20V, $I_{OUT} = 100\mu A$ to 500mA, $T_J = -40^\circ C$ to $+125^\circ C$	$I_{OUT} = 10mA$ , $T_J = +25^\circ C$	1.188	1.2	1.212	V
				1.181		1.219	
ADJ Input Bias Current	$I_{ADJ}$	$V_{ADJ} = V_{OUT(NOM)} + 0.1V$	-6		6	nA	
Under-Voltage Lockout Thresholds	$V_{UVLO}$	$V_{IN}$ rising		2.52	2.70	V	
		$V_{IN}$ falling	2.16	2.33			
Line Regulation	$\frac{\Delta V_{OUT}}{\Delta V_{IN} \times V_{OUT}}$	$V_{IN} = (V_{OUT(NOM)} + 1V)$ to 20V		0.001	0.007	%/V	
Load Regulation	$\Delta V_{OUT}$	$I_{OUT} = 100\mu A$ to 500mA		3	26	mV	
Dropout Voltage <sup>(1)</sup>	$V_{DROP}$	$I_{OUT} = 500mA$	$V_{OUT(NOM)} = 2.5V$		500	730	mV
			$V_{OUT(NOM)} = 3.0V$		450	680	
			$V_{OUT(NOM)} = 5.0V$		360	580	
Output Current Limit	$I_{LIMIT}$	$V_{OUT} = V_{OUT(NOM)} - 1V$ <sup>(2)</sup>	510	800		mA	
Operating Supply Current	$I_{GND}$	$I_{OUT} = 0\mu A$		43	70	$\mu A$	
		$I_{OUT} = 500mA$		980	1180		
Shutdown Current	$I_{SHDN}$	$V_{EN} = 0V$		1.4	2.7	$\mu A$	
		$V_{EN} = 0V$ , $V_{IN} = 20V$		1.5	3.2		
Input Reverse Current	$I_{REV-INPUT}$	$V_{EN} = 0V$ , $V_{IN} = 0V$ , $V_{OUT} = 20V$		0.05	1	$\mu A$	
Soft-Start Source Current	$SS_{I-SOURCE}$	$SS = 0V$		1	3	$\mu A$	
Precision EN Input	$V_{IH}$	Logic high, $V_{IN} = 2.7V$ to 20V	1.120	1.210	1.295	V	
	$V_{IL}$	Logic low, $V_{IN} = 2.7V$ to 20V	1.050	1.120	1.195		
Leakage Current	$I_{EN-LKG}$	$V_{EN} = V_{IN}$ , $V_{IN} = 2.7V$ to 20V		0.1	1	$\mu A$	
Output Discharge Resistance	$R_{DIS}$	$V_{EN} = 0V$ , $V_{OUT} = 0.5V$		100	140	$\Omega$	
Start-Up Time	$t_{STR}$	From EN rising from 0V to $V_{IN}$ to $0.9 \times V_{OUT}$ , $V_{OUT} = 1.2V$		150		$\mu s$	
Power Supply Rejection Ratio	PSRR	$V_{IN} = V_{OUT(NOM)} + 1V$	$f = 1kHz$		100	dB	
			$f = 10kHz$		83		
			$f = 100kHz$		52		
			$f = 1MHz$		55		
Output Voltage Noise	$e_n$	$f = 10Hz$ to 100kHz, $I_{OUT} = 1mA$	$V_{OUT} = 1.2V$		9.3	$\mu V_{RMS}$	
			$V_{OUT} = 2.8V$		11		
			$V_{OUT} = 5.0V$		14		
Thermal Shutdown Temperature	$T_{SHDN}$			160		$^\circ C$	
Thermal Shutdown Hysteresis	$\Delta T_{SHDN}$			20		$^\circ C$	

## NOTES:

- The dropout voltage is defined as the difference between  $V_{IN}$  and  $V_{OUT}$  when  $V_{OUT}$  falls to  $95\% \times V_{OUT(NOM)}$ .
- $V_{OUT} = V_{OUT(NOM)} - 0.2V$  when  $V_{OUT} = 1.2V$ .

TYPICAL PERFORMANCE CHARACTERISTICS

$T_J = +25^\circ\text{C}$ ,  $V_{IN} = (V_{OUT(NOM)} + 1\text{V})$  or  $2.7\text{V}$  (whichever is greater),  $V_{EN} = V_{IN}$ ,  $I_{OUT} = 10\text{mA}$ ,  $C_{IN} = 2.2\mu\text{F}$  and  $C_{OUT} = 2.2\mu\text{F}$ , unless otherwise noted.

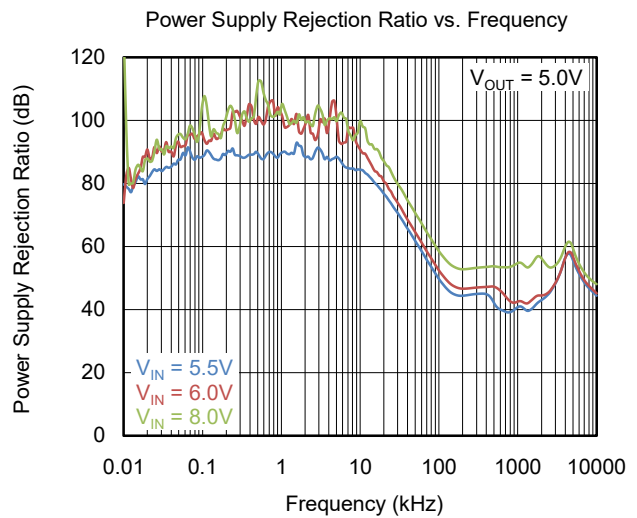
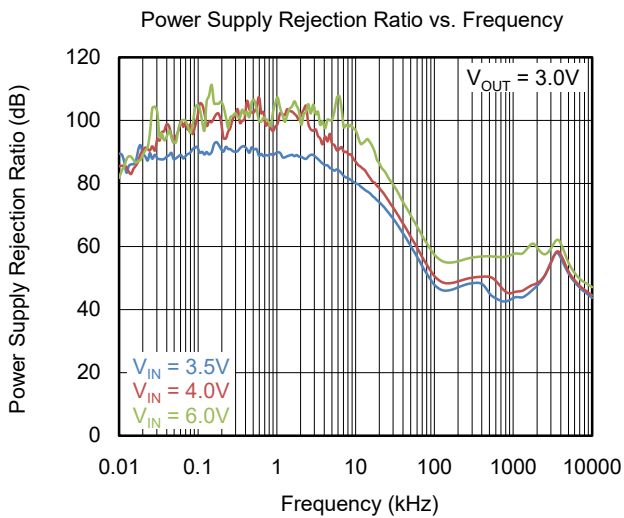
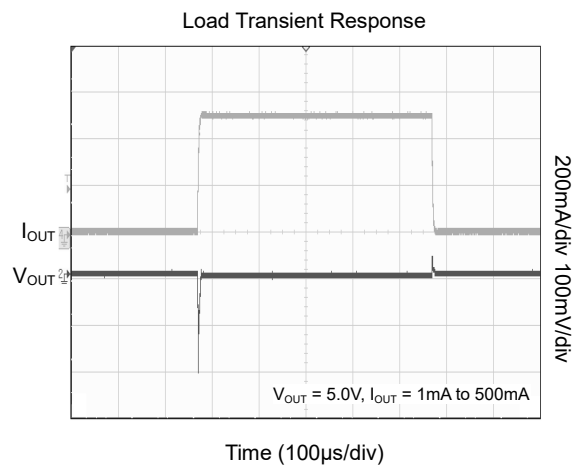
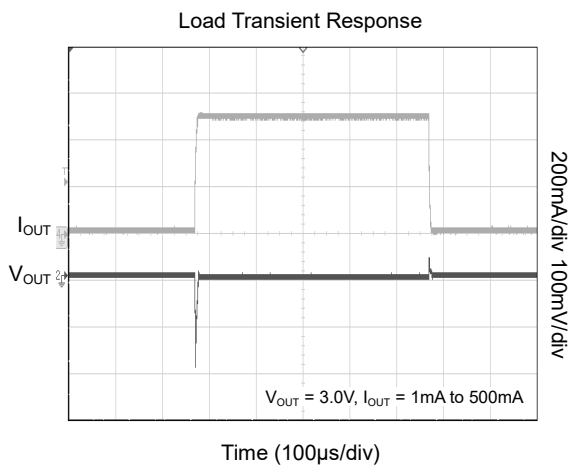
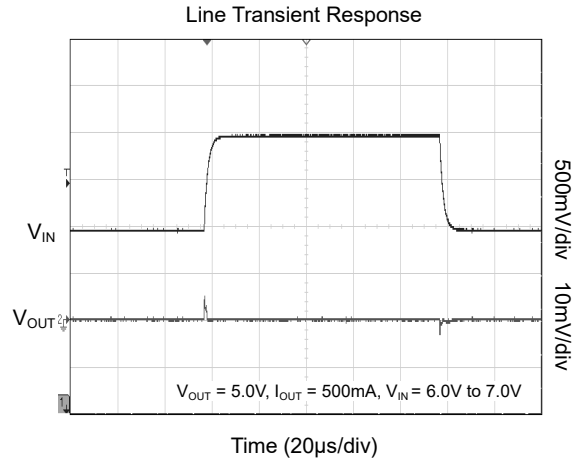
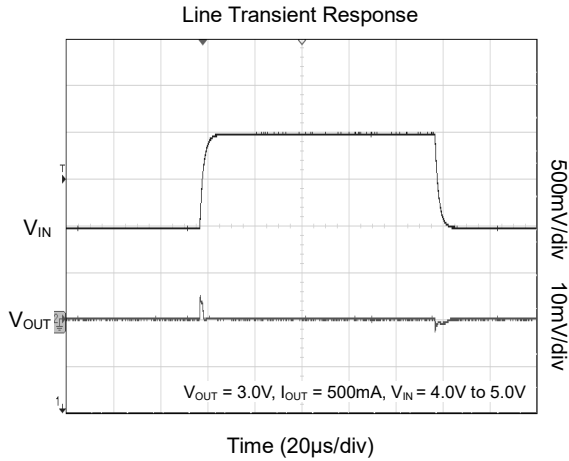

TYPICAL PERFORMANCE CHARACTERISTICS (continued)

$T_J = +25^\circ\text{C}$ ,  $V_{IN} = (V_{OUT(NOM)} + 1\text{V})$  or  $2.7\text{V}$  (whichever is greater),  $V_{EN} = V_{IN}$ ,  $I_{OUT} = 10\text{mA}$ ,  $C_{IN} = 2.2\mu\text{F}$  and  $C_{OUT} = 2.2\mu\text{F}$ , unless otherwise noted.

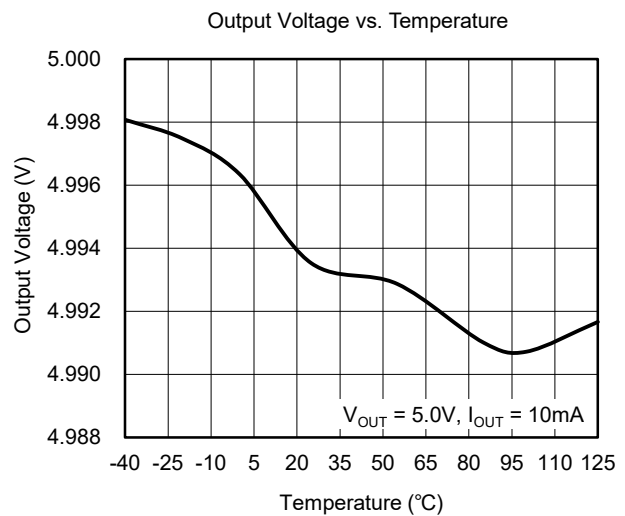
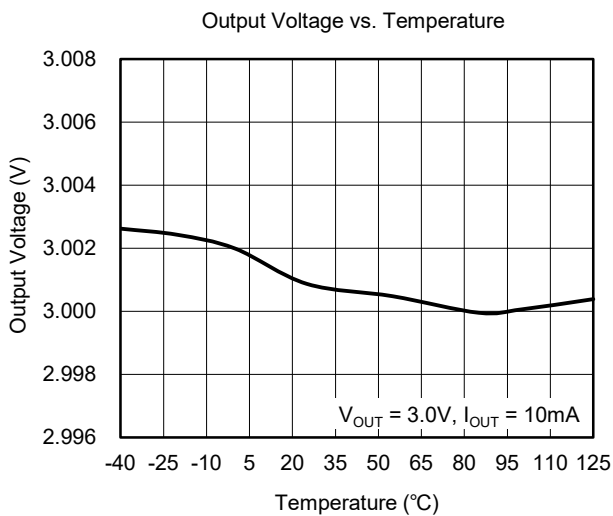
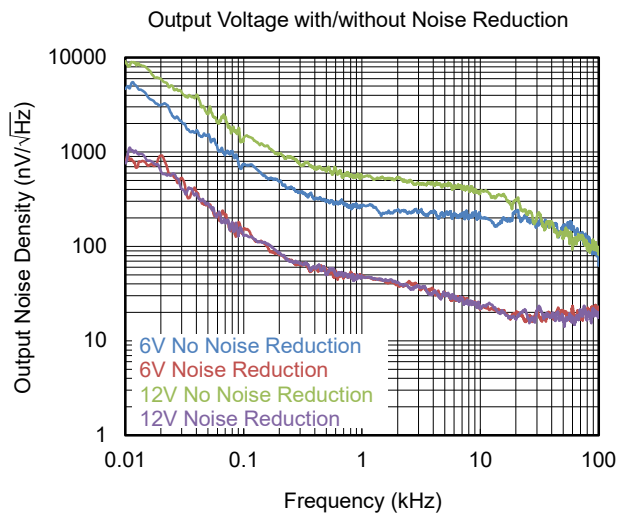
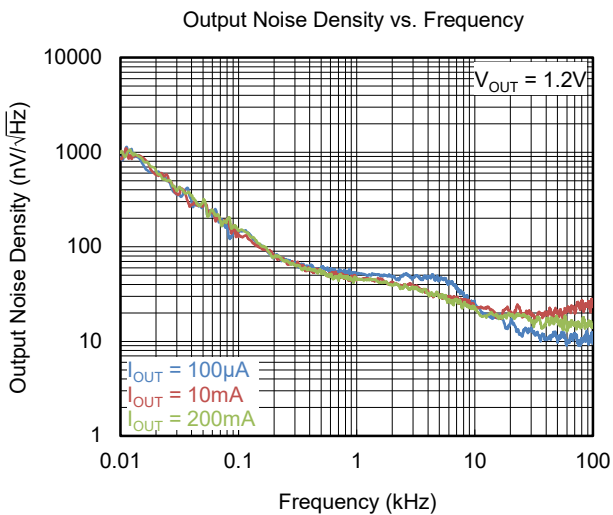
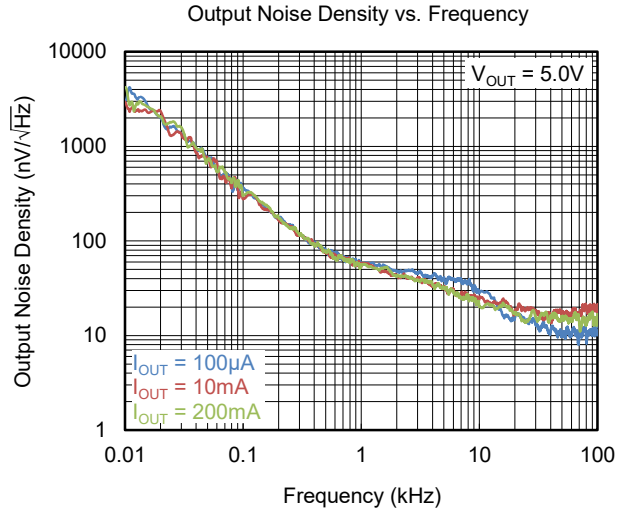
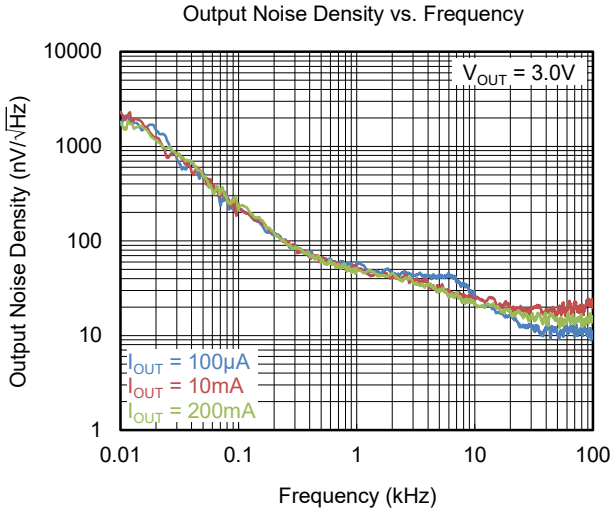

**TYPICAL PERFORMANCE CHARACTERISTICS (continued)**

$T_J = +25^\circ\text{C}$ ,  $V_{IN} = (V_{OUT(NOM)} + 1\text{V})$  or  $2.7\text{V}$  (whichever is greater),  $V_{EN} = V_{IN}$ ,  $I_{OUT} = 10\text{mA}$ ,  $C_{IN} = 2.2\mu\text{F}$  and  $C_{OUT} = 2.2\mu\text{F}$ , unless otherwise noted.

Ground Pin Current vs. Temperature

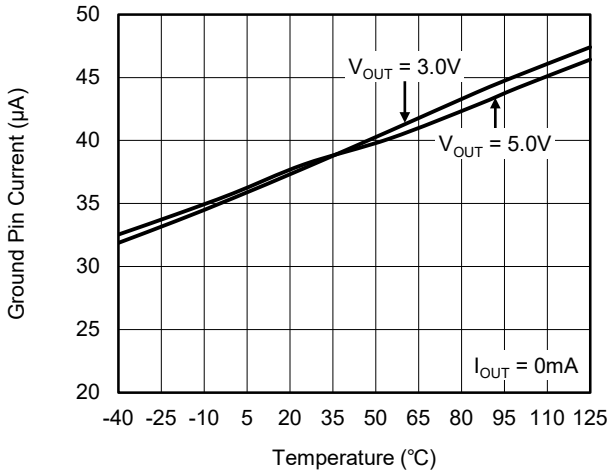

Ground Pin Current vs. Temperature

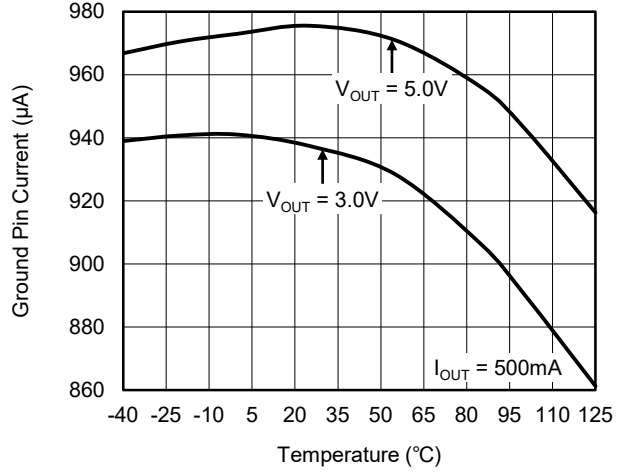

Shutdown Current vs. Temperature

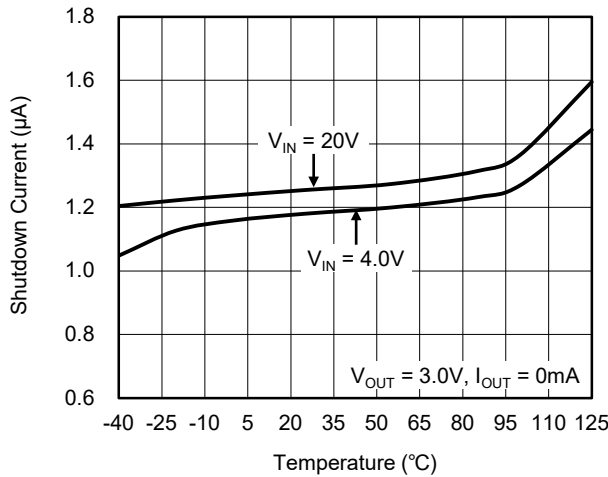

Shutdown Current vs. Temperature

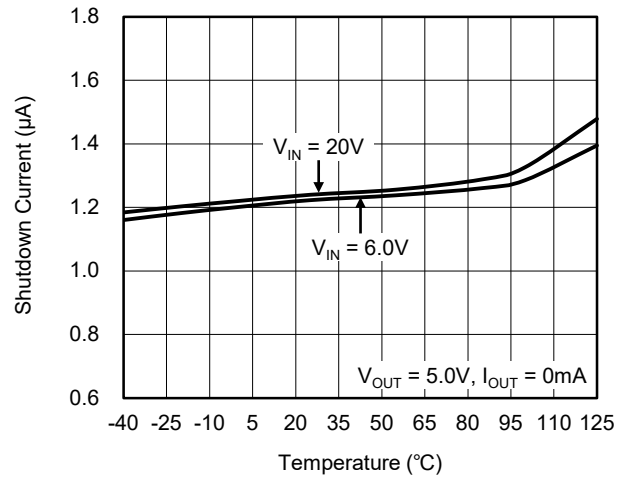

Dropout Voltage vs. Temperature

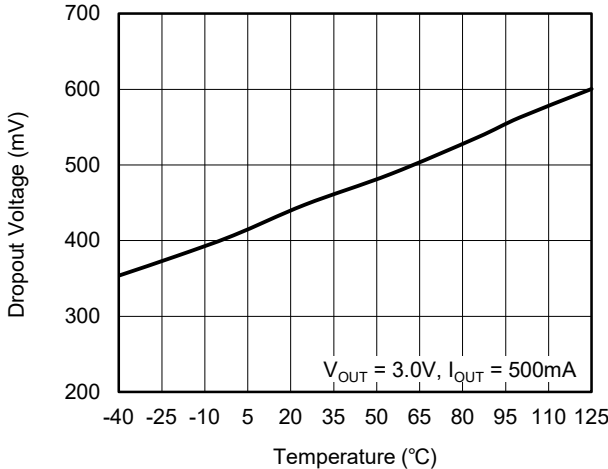

Dropout Voltage vs. Temperature

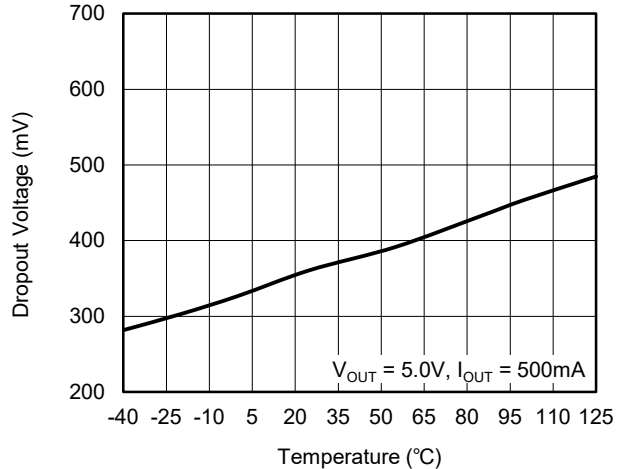



TYPICAL PERFORMANCE CHARACTERISTICS (continued)

$T_J = +25^\circ\text{C}$ ,  $V_{IN} = (V_{OUT(NOM)} + 1\text{V})$  or  $2.7\text{V}$  (whichever is greater),  $V_{EN} = V_{IN}$ ,  $I_{OUT} = 10\text{mA}$ ,  $C_{IN} = 2.2\mu\text{F}$  and  $C_{OUT} = 2.2\mu\text{F}$ , unless otherwise noted.

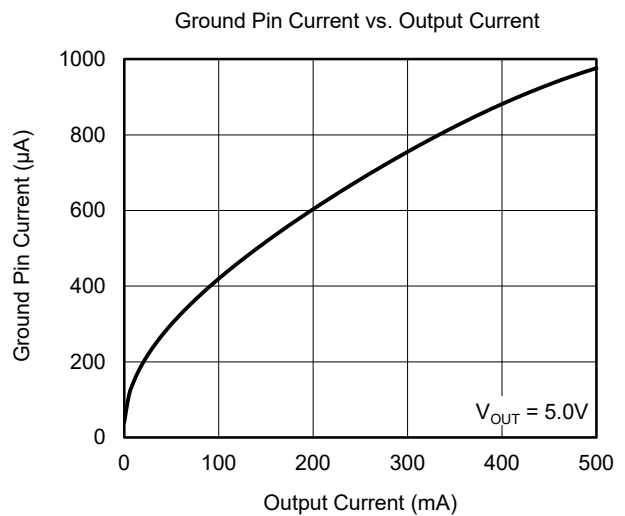
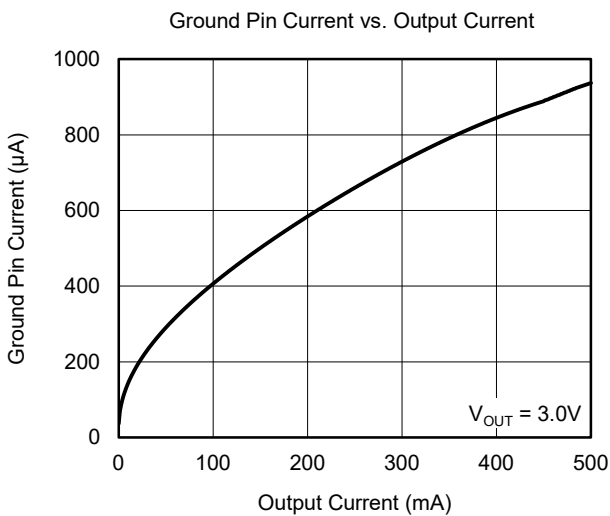
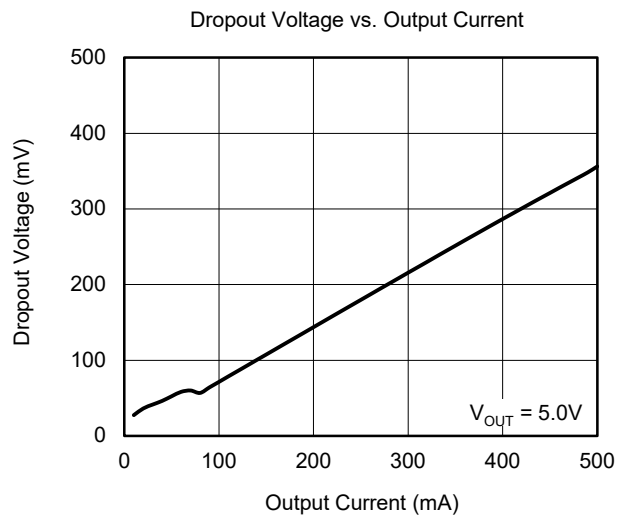
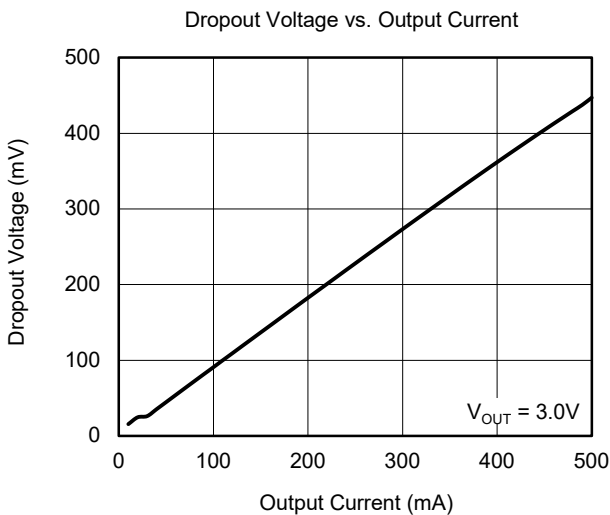
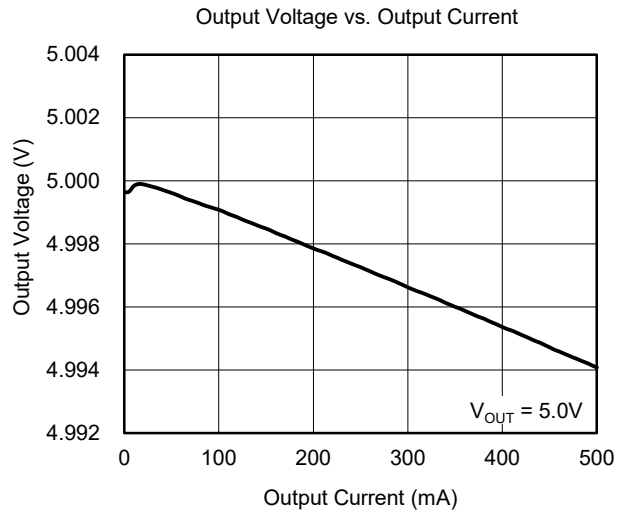
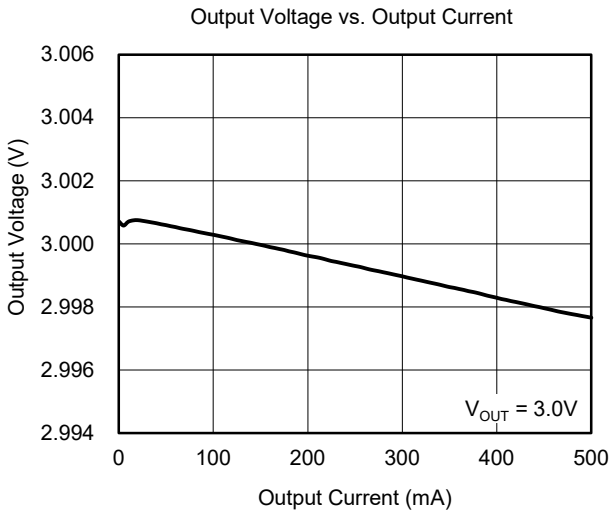

**TYPICAL PERFORMANCE CHARACTERISTICS (continued)**

$T_J = +25^{\circ}\text{C}$ ,  $V_{IN} = (V_{OUT(NOM)} + 1\text{V})$  or  $2.7\text{V}$  (whichever is greater),  $V_{EN} = V_{IN}$ ,  $I_{OUT} = 10\text{mA}$ ,  $C_{IN} = 2.2\mu\text{F}$  and  $C_{OUT} = 2.2\mu\text{F}$ , unless otherwise noted.

Ground Pin Current vs. Input Voltage

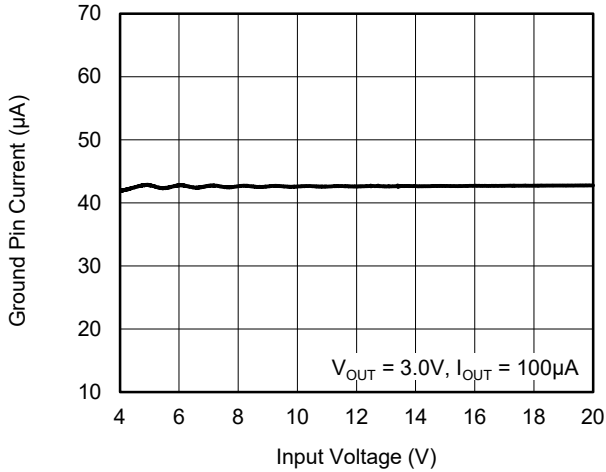

Ground Pin Current vs. Input Voltage

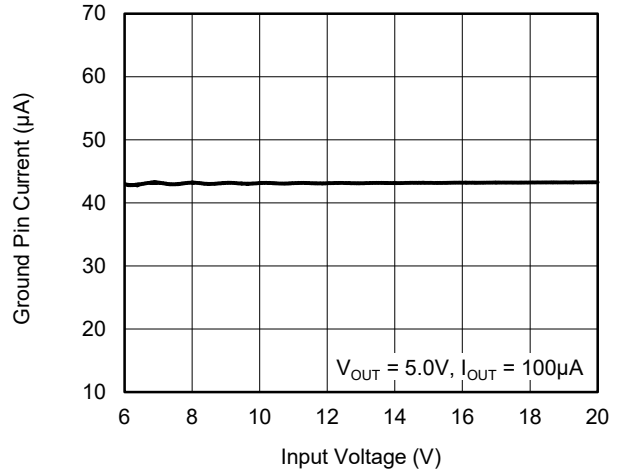

Typical Start-Up Behavior

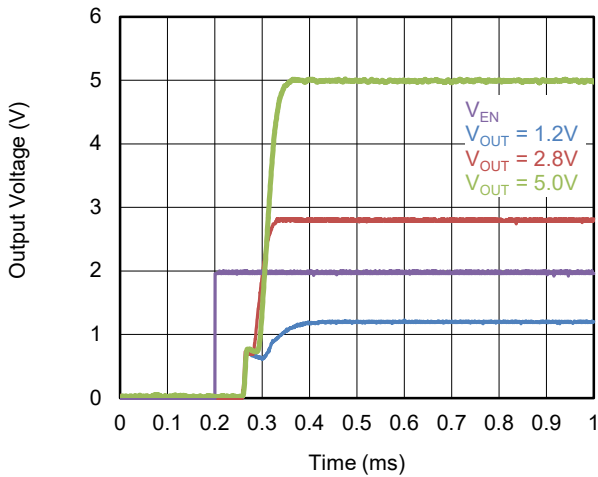

Typical Soft-Start Behavior, Different C<sub>SS</sub>

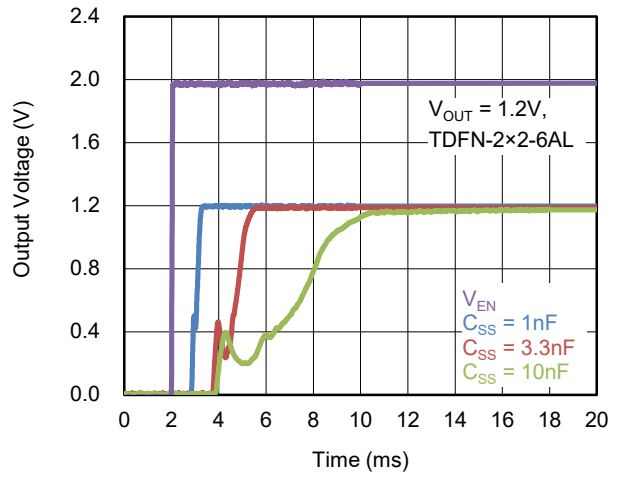

Typical Soft-Start Behavior, Different C<sub>SS</sub>

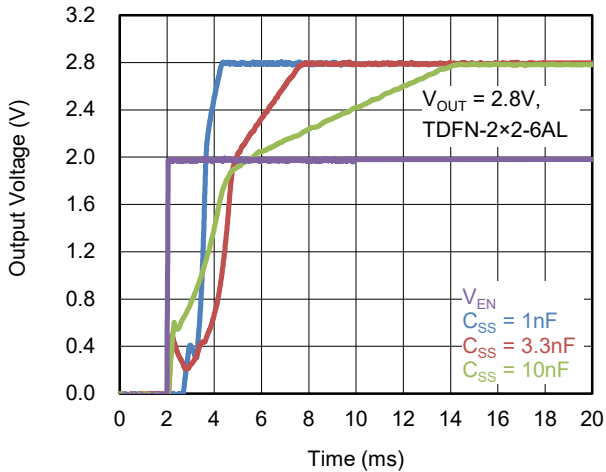

Typical Soft-Start Behavior, Different C<sub>SS</sub>

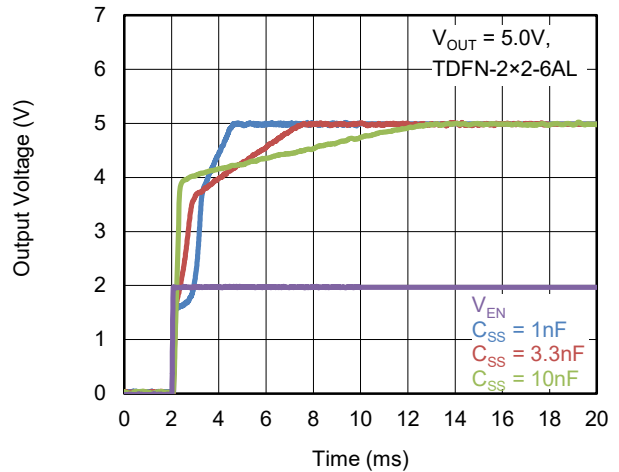

TYPICAL PERFORMANCE CHARACTERISTICS (continued)

$T_J = +25^\circ\text{C}$ ,  $V_{IN} = (V_{OUT(NOM)} + 1\text{V})$  or  $2.7\text{V}$  (whichever is greater),  $V_{EN} = V_{IN}$ ,  $I_{OUT} = 10\text{mA}$ ,  $C_{IN} = 2.2\mu\text{F}$  and  $C_{OUT} = 2.2\mu\text{F}$ , unless otherwise noted.

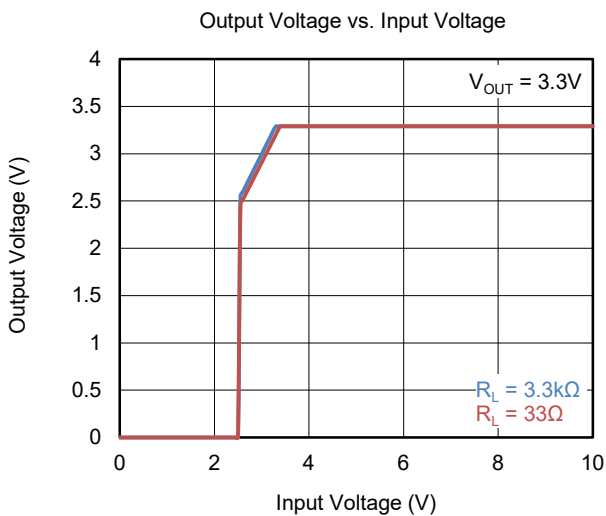
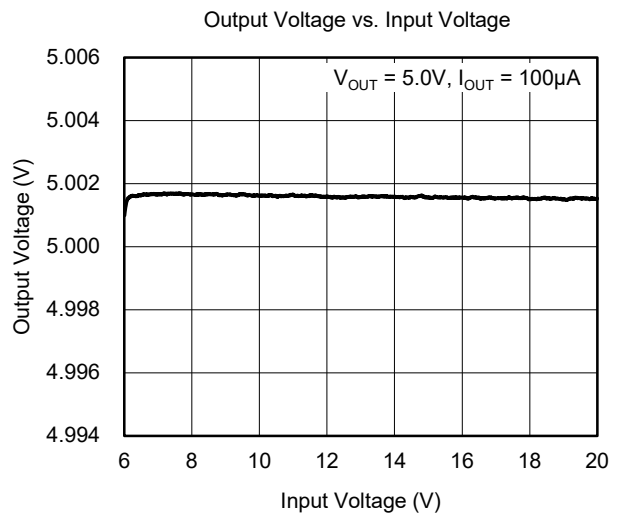
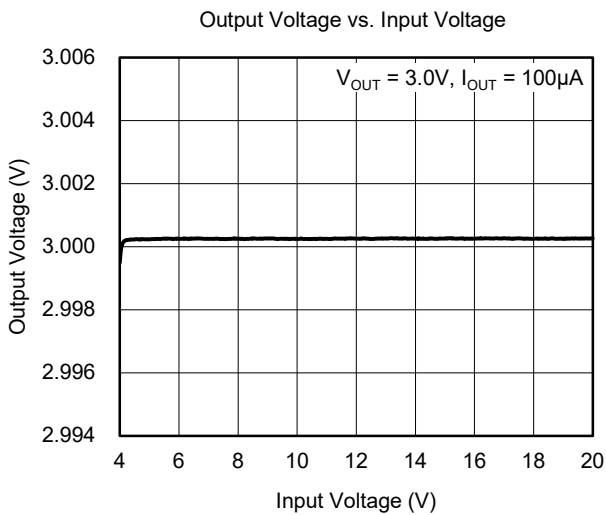
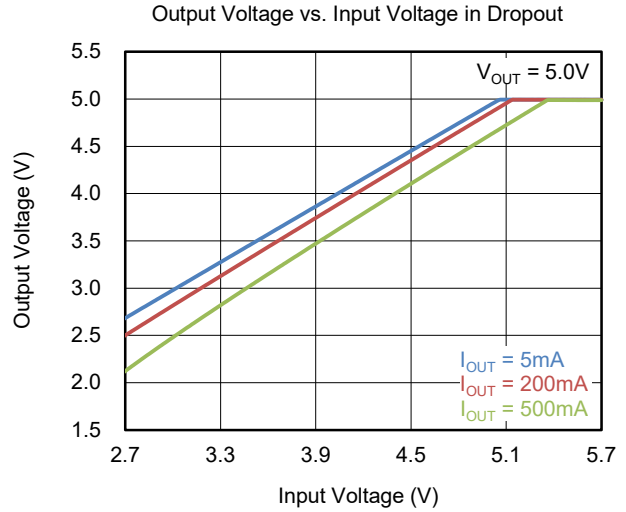
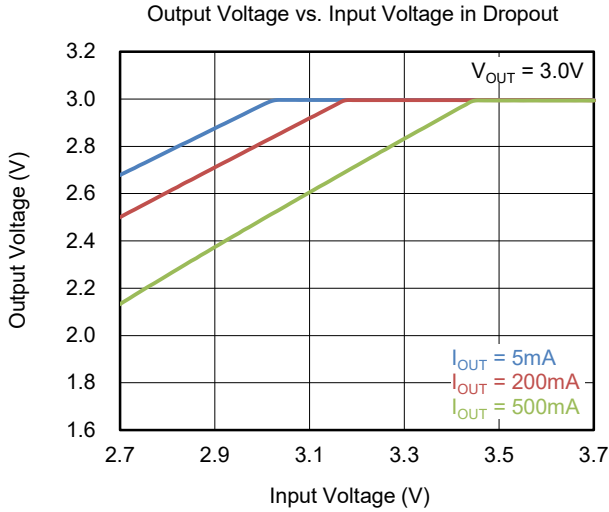

TYPICAL APPLICATION CIRCUITS

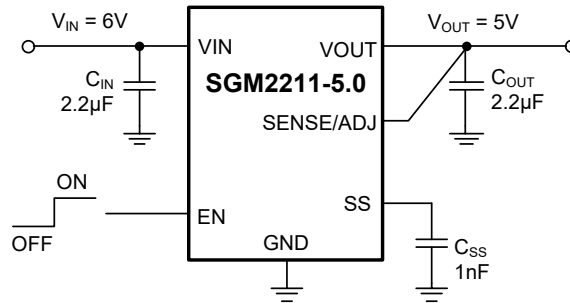

Figure 1. SGM2211 with Fixed Output Voltage, 5V (TDFN-2x2-6AL)

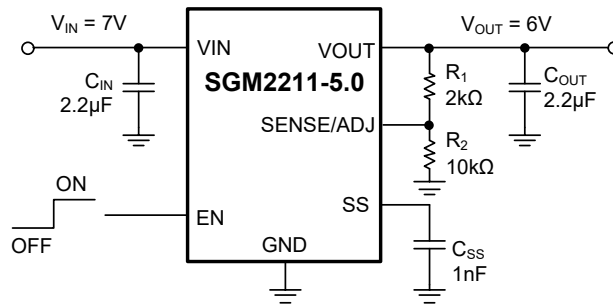

Figure 2. SGM2211 with 5V Output Adjusted to 6V (TDFN-2x2-6AL)

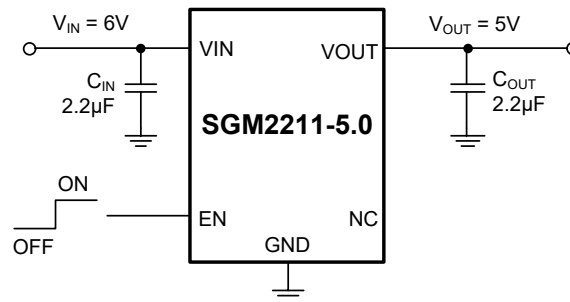

Figure 3. SGM2211 with Fixed Output Voltage, 5V (SOT-23-5)

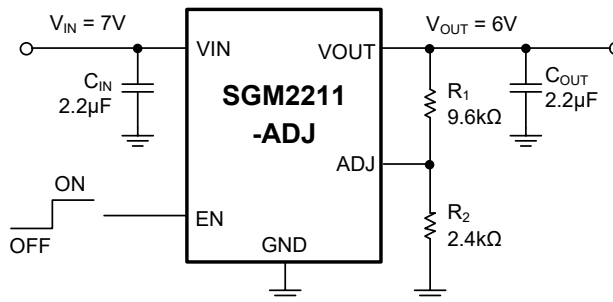

Figure 4. SGM2211 with 1.2V Output Adjusted to 6V (SOT-23-5)

FUNCTIONAL BLOCK DIAGRAMS

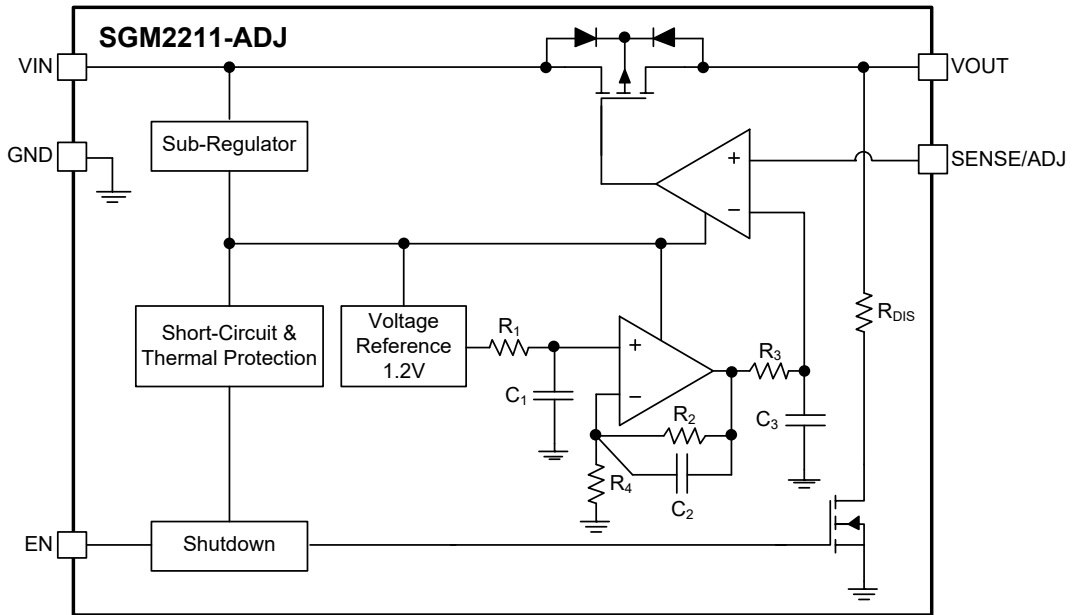

Figure 5. Block Diagram (TDFN-2x2-6AL and SOT-23-5 Adjustable Version)

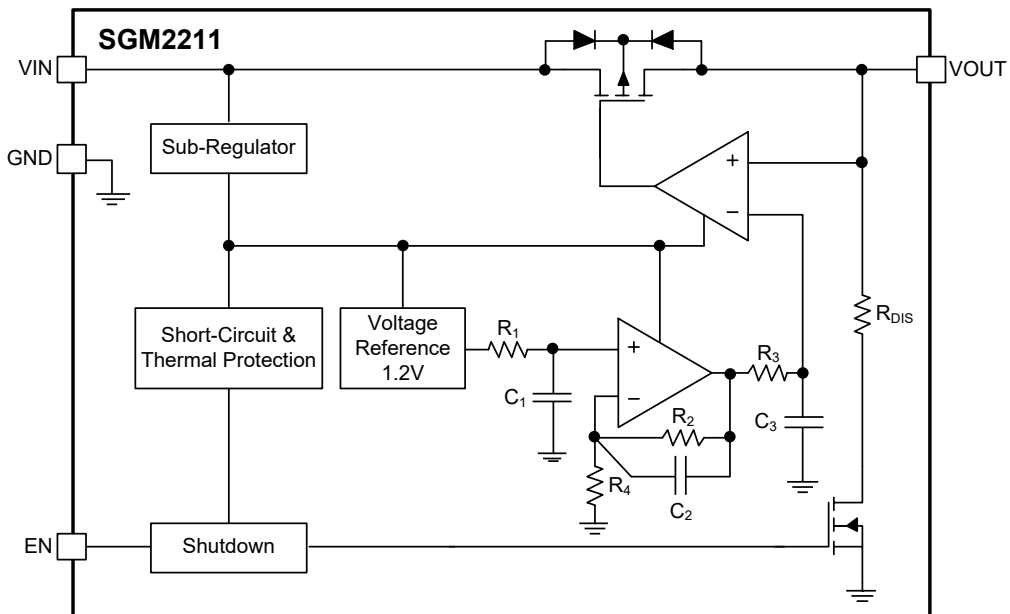

Figure 6. Block Diagram (SOT-23-5 Fixed Version)

## APPLICATION INFORMATION

The SGM2211 is a low noise, fast transient response high performance LDO, it consumes only 43µA (TYP) quiescent current and provides 500mA output current. The SGM2211 provides the protection function for output overload, output short-circuit condition and overheating.

### Input Capacitor Selection ( $C_{IN}$ )

The input decoupling capacitor should be placed as close as possible to the VIN pin to ensure the device stability. 2.2µF or larger X7R or X5R ceramic capacitor is selected to get good dynamic performance.

When  $V_{IN}$  is required to provide large current instantaneously, a large effective input capacitor is required. Multiple input capacitors can limit the input tracking inductance. Adding more input capacitors is available to restrict the ringing and to keep it below the device absolute maximum ratings. For  $C_{OUT}$  with larger capacitance, it is recommended to choose the larger capacitance  $C_{IN}$ .

### Output Capacitor Selection ( $C_{OUT}$ )

The output capacitor should be placed as close as possible to the VOUT pin. 2.2µF or greater X7R or X5R ceramic capacitor is selected to get good dynamic performance. The minimum effective capacitance of  $C_{OUT}$  that SGM2211 can remain stable is 1.5µF. For ceramic capacitor, temperature, DC bias and package size will change the effective capacitance, so enough margin of  $C_{OUT}$  must be considered in design. Additionally,  $C_{OUT}$  with larger capacitance and lower ESR will help increase the high frequency PSRR and improve the load transient response.

### Adjustable Regulator

The output voltage of the SGM2211-1.2 can be adjusted from 1.2V to ( $V_{IN} - V_{DROP}$ ). The ADJ pin will be connected to two external resistors as shown in Figure 7. The output voltage is determined by the following equation:

$$V_{OUT} = V_{ADJ} \times \left( 1 + \frac{R_1}{R_2} \right) \quad (1)$$

where:

$V_{OUT}$  is output voltage and  $V_{ADJ}$  is the internal voltage reference,  $V_{ADJ} = 1.2V$ .

The parallel capacitor ( $C_{FF}$ ) with  $R_1$  can be used to improve the feedback loop stability and PSRR,

increase the transient response and reduce the AC gain of the error amplifier and output noise.

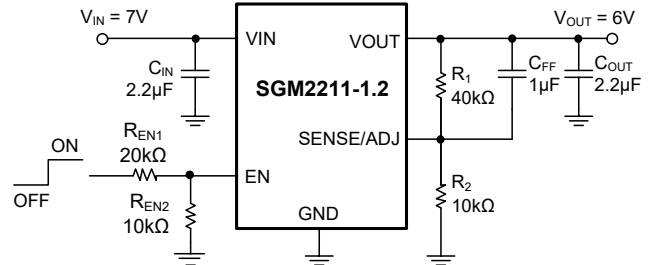

Figure 7. SGM2211 with 1.2V Output Adjusted to 6V

### Programmable Precision Enable Operation

The SGM2211 uses the EN pin to enable/disable the device and to deactivate/activate the output automatic discharge function.

When the EN pin voltage is lower than 1.1V, the device is in shutdown state. There is no current flowing from VIN to VOUT pins. In this state, the automatic discharge transistor is active to discharge the output voltage through a 100Ω (TYP) resistor.

When the EN pin voltage is higher than 1.2V, the device is in active state. The output voltage is regulated to the expected value and the automatic discharge transistor is turned off.

The EN pin voltage threshold can be programmed by the user and set above the nominal 1.2V by using two resistors ( $R_{EN1}$ ,  $R_{EN2}$ ) as shown in Figure 7. The resistance value of  $R_{EN1}$  can be determined by the following equation:

$$R_{EN1} = R_{EN2} \times (V_{IN} - 1.2V) / 1.2V \quad (2)$$

where  $V_{IN}$  is the required starting voltage.

The coefficient of hysteresis voltage increase can be calculated through  $(R_{EN1} + R_{EN2}) / R_{EN2}$ . It is calculated that the EN pin voltage threshold is 3.6V and the voltage increase is 300mV.

### Soft-Start

When the device is enabled, the SGM2211 has an internal soft-start (SS pin open) to limit the inrush current. When  $V_{OUT} = 1.2V$ , the start-up time is 150µs (TYP).

**APPLICATION INFORMATION (continued)**

**Output Current Limit and Short-Circuit Protection**

When overload events happen, the output current is internally limited to 800mA (TYP). When the VOUT pin is shorted to ground, the short-circuit protection will limit the output current.

**Thermal Shutdown**

When the die temperature exceeds the threshold value of thermal shutdown, the SGM2211 will be in shutdown

state and it will remain in this state until the die temperature decreases to +140°C.

**Layout Guidelines**

To get good PSRR, low output noise and high transient response performance, the input and output bypass capacitors must be placed as close as possible to the VIN pin and VOUT pin separately.

**REVISION HISTORY**

NOTE: Page numbers for previous revisions may differ from page numbers in the current version.

<b>MAY 2024 – REV.A.4 to REV.B</b>	<b>Page</b>
Updated Absolute Maximum Ratings section.....	3
Updated Electrical Characteristics section.....	5
<b>JANUARY 2024 – REV.A.3 to REV.A.4</b>	<b>Page</b>
Updated Typical Performance Characteristics section.....	11
Updated Application Information section.....	14
<b>NOVEMBER 2022 - REV.A.2 to REV.A.3</b>	<b>Page</b>
Updated Application Information section.....	14, 15
<b>OCTOBER 2022 - REV.A.1 to REV.A.2</b>	<b>Page</b>
Updated Features section.....	1
<b>MARCH 2020 - REV.A to REV.A.1</b>	<b>Page</b>
Updated Figure 7.....	14
<b>Changes from Original (DECEMBER 2019) to REV.A</b>	<b>Page</b>
Changed from product preview to production data.....	All

PACKAGE OUTLINE DIMENSIONS

TDFN-2x2-6AL

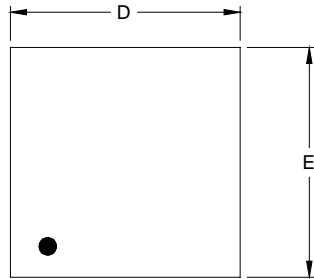

TOP VIEW

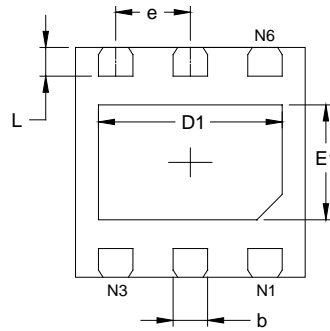

BOTTOM VIEW

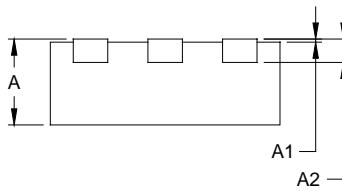

SIDE VIEW

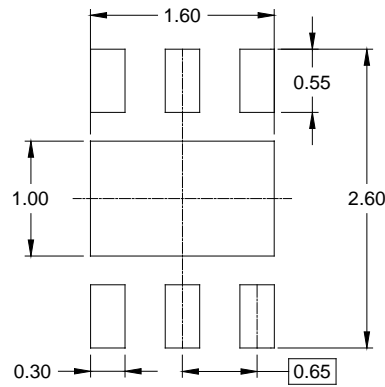

RECOMMENDED LAND PATTERN (Unit: mm)

Symbol	Dimensions In Millimeters		Dimensions In Inches	
	MIN	MAX	MIN	MAX
A	0.700	0.800	0.028	0.031
A1	0.000	0.050	0.000	0.002
A2	0.203 REF		0.008 REF	
D	1.900	2.100	0.075	0.083
D1	1.500	1.700	0.059	0.067
E	1.900	2.100	0.075	0.083
E1	0.900	1.100	0.035	0.043
b	0.250	0.350	0.010	0.014
e	0.650 BSC		0.026 BSC	
L	0.174	0.326	0.007	0.013

NOTE: This drawing is subject to change without notice.



## PACKAGE OUTLINE DIMENSIONS

### SOT-23-5

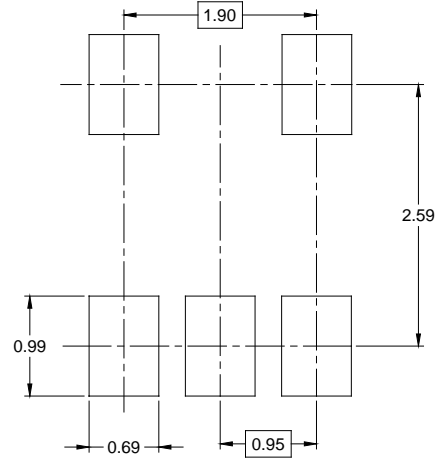
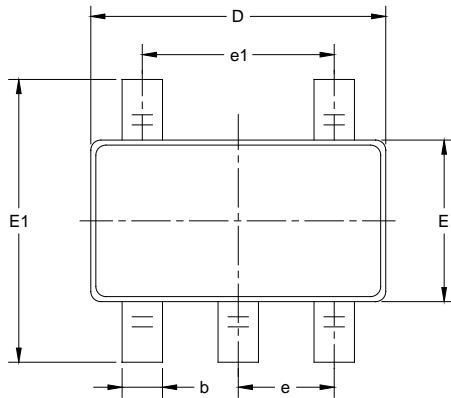

RECOMMENDED LAND PATTERN (Unit: mm)

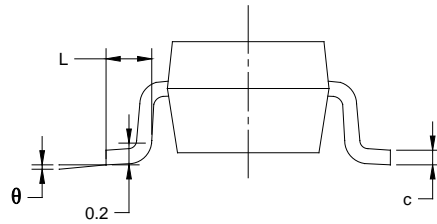
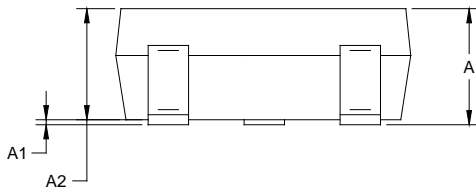

Symbol	Dimensions In Millimeters		Dimensions In Inches	
	MIN	MAX	MIN	MAX
A	1.050	1.250	0.041	0.049
A1	0.000	0.100	0.000	0.004
A2	1.050	1.150	0.041	0.045
b	0.300	0.500	0.012	0.020
c	0.100	0.200	0.004	0.008
D	2.820	3.020	0.111	0.119
E	1.500	1.700	0.059	0.067
E1	2.650	2.950	0.104	0.116
e	0.950 BSC		0.037 BSC	
e1	1.900 BSC		0.075 BSC	
L	0.300	0.600	0.012	0.024
$\theta$	0°	8°	0°	8°

NOTES:

1. Body dimensions do not include mode flash or protrusion.
2. This drawing is subject to change without notice.

**TAPE AND REEL INFORMATION**

**REEL DIMENSIONS**



**TAPE DIMENSIONS**



NOTE: The picture is only for reference. Please make the object as the standard.

**KEY PARAMETER LIST OF TAPE AND REEL**

Package Type	Reel Diameter	Reel Width W1 (mm)	A0 (mm)	B0 (mm)	K0 (mm)	P0 (mm)	P1 (mm)	P2 (mm)	W (mm)	Pin1 Quadrant
TDFN-2×2-6AL	7"	9.5	2.30	2.30	1.10	4.0	4.0	2.0	8.0	Q1
SOT-23-5	7"	9.5	3.20	3.20	1.40	4.0	4.0	2.0	8.0	Q3

DD0001

# PACKAGE INFORMATION

## CARTON BOX DIMENSIONS



NOTE: The picture is only for reference. Please make the object as the standard.

## KEY PARAMETER LIST OF CARTON BOX

Reel Type	Length (mm)	Width (mm)	Height (mm)	Pizza/Carton
7" (Option)	368	227	224	8
7"	442	410	224	18

DD0002