

HW Series – 22mm IEC Style Global Pushbuttons

Key features:

- Locking lever removable contact blocks
- Finger-safe IP20 contacts
- Tamperproof construction
- All E-stops meet EN60947-5-5, and are compliant with SEMI S2 standards
- Worldwide approvals
- Easy to assemble
- Choice of black plastic or metallic front bezels
- LED illumination
- Transformer or full voltage
- Slow make double break contacts



HW: The Best Engineered Switch in the World

IDEC's HW switches are "The best engineered switch in the world" for a reason. Carrying the CE mark, UL, CSA, CCC (Chinese), and TUV approvals, these switches are designed for use in almost any part of the world.

Complete with finger-safe contact blocks offering IP20 protection, these 7/8" (22mm) switches

include illuminated and non-illuminated pushbuttons, pilot lights, selector switches, and emergency stop switches.

All switches also incorporate mechanically keyed safety locking levers, ensuring correct installation and maintaining safety in high-vibration applications.



File No. E68961



File No. LR21451



TUV Rheinland
Certificate No.
R50086203_HW_e-stop
R50391189_HW



Certificate No.
2017010305987846

Specifications

Electrical	Rated Operational Characteristics	AC-15: A600 or Ue = 250V, Ie = 3A (NO, NC, NO-EM, NC-LB) DC-13: P600 or Ue = 125V, Ie = 1.1A (NO, NC) DC-13: Q600 or Ue = 125V, Ie = 0.9A (NO-EM, NC-LB)					
	Rated Insulation Voltage	600V					
	Rated Switching Over-Voltage	Less than 4kV, conforming to IEC60947-1					
	Rated Impulse Withstanding Voltage	4kV for contact circuit, 2.5kV for lamp circuit					
	Rated Thermal Current	10 Amp					
	Minimum Switching Capacity	5 mA at 3V AC/DC					
	Electrical Reliability	MTBF < 1 fault for 10 million operation cycles (3V DC, 5mA)					
Lamp Ratings	LEDs: 6V/17mA max, 12V & 24V/11mA max, 120 & 240V/10mA max						
Mechanical	Contact Operation	Slow break NC or NO					
	Positive Action Operation (Emergency Stops with NC contacts)	5.5mm to 10mm travel to latch, 45N minimum force to latch 10mm maximum travel, 1,800 operations per hour maximum for a Pushlock Turn Reset 900 operations per hour maximum for a Push-Pull					
	Operating Force	Flush and extended pushbuttons—with 1NO or 1NC contact: 6.2±2N (momentary), 7.0±2N (maintained) Additional contacts—1NO or 1NC: +3.2N (momentary), + 3.3N (maintained)					
	Recommended Terminal Torque	Unit	Wire	Number of Wires	Recommended Tightening Torque (Nm)	Terminal Screw	
							Crimping Terminal
		HW-U Contact Block	Solid Wire	ø0.5 to 1.6 mm (AWG14 to 22)	2	1.0 to 1.3	
				Stranded Wire	ø1.7 to 2.0 mm (AWG12) 0.3 to 2.0 mm ² (AWG14 to 22) 2.1 to 3.5 mm ² (AWG12)	1 2 1	1.2 to 1.3 1.0 to 1.3 1.2 to 1.3
	Illuminated Unit (*1)	Solid Wire	ø0.5 to 1.6 mm (AWG14 to 22)	2	1.0 to 1.3	M3.5	
			Stranded Wire	0.3 to 2.0 mm (AWG14 to 22)			
	Applicable Wire Size	Pilot Light	Crimping Terminal		0.6 to 1.0 (M3.0)		
Solid Wire			ø0.5 to 1.6 mm (AWG14 to 22)	2			1.0 to 1.3 (M3.5)
		Stranded Wire	ø0.3 to 2.0 mm (AWG14 to 22)				
1. * refers to the lamp terminals of the illuminated push buttons and selector switches.							
Applicable Wire Size	Minimum 1 x 22 AWG, max. 2 x 14 AWG or 1 x 12 AWG						
Contact Resistance	Initial contact resistance of 50mΩ or less						
Contact Gap	4mm (NO and NC), 2mm (NO-EM and NC-LB)						
Horsepower Rating	Reference Value: 1/4 HP @ 120V (1ø non-reversing), 1HP @ 240V (3ø non-reversing)						
Contact Material	Silver (gold plated contacts available - contact IDEC)						
Operating Temperature	Operation: -25 to +60°C (illuminated -25 to +50°C dome -25 to +55°C)						
Vibration Resistance	10 to 55Hz, 98m/sec ² (10G) conforming to IEC6068-2-6						
Shock Resistance	980m/sec ² (100G) conforming to IEC6068-2-7						
Mechanical Life	Momentary pushbuttons: 5,000,000 (900 operations per hour), All other switches: 500,000						

Switches & Pilot Devices

Signaling Lights

Relays & Sockets

Timers

Connectors

Terminal Blocks

Circuit Breakers

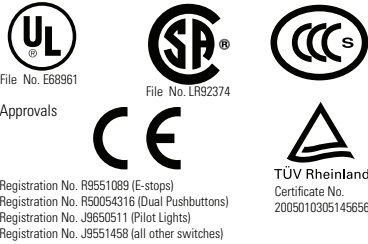
Conforming to Standards		EN60947-1, EN60947-5-1, VDE0660-200, UL508, CSA C22-2 No.14							
 <p>File No. E68961 File No. LR92374 Registration No. R9551089 (E-stops) Registration No. R50054316 (Dual Pushbuttons) Registration No. J9650511 (Pilot Lights) Registration No. J9551458 (all other switches)</p>		<p>CSA: pushbuttons and selector switches: A600 pilot lights and illuminated pushbuttons, direct supply pilot lights and illuminated pushbuttons with integral transformer (100/110, 115, 120, 200/220, 230, 240, 380, 400/440, 480V) UL: pushbuttons and selector switches: A600 pilot lights and illuminated pushbuttons, direct supply pilot lights and illuminated pushbuttons with integral transformer (100/110, 115, 120, 200/220, 230, 240, 380, 400/440, 480V) TUV: pushbuttons and selector switches: A600-P600 (NO, NC)/Q600 (NO-EM, NC-LB) pilot lights and illuminated pushbuttons, direct supply pilot lights and illuminated pushbuttons with integral transformer (100/110, 115, 120, 200/220, 230, 240, 380, 400/440, 480V)</p>							
Electric Shock Protection		Class 2 conforming to IEC60664-7							
Degree of Protection (conforming to IEC60529 and UL50)		UL Type 1, 4X, 12, 13 ¹ IP65 (from front of the panel) IP20 (Type HW-U contact block)							
Pollution Degree (conforming to IEC60947-1)		3							
External Short-Circuit Protection		10A 250V fuse conforming to IEC60269-1							
Contact Ratings	Pushbuttons	Contact Block			Type HW-U				
	Illuminated Pushbuttons Selector Switches Illuminated Selector Switches Pushbutton Selectors	Rated Insulation Voltage			600V				
		Rated Continuous Current			10A				
		Contact Ratings by Utilization Category IEC 60947-5-1			AC-15 (A600) DC-13 (P600)				
Characteristics	Operational Voltage		24V	48V	50V	110V	220V	440V	
	Operational Current	AC 50/60 Hz	AC-12 Control of resistive loads & solid state loads	10A	—	10A	10A	6A	2A
			AC-15 Control of electromagnetic loads (> 72VA)	10A	—	7A	5A	3A	1A
		DC	DC-12 Control of resistive loads & solid state loads	10A	5A	—	2.2A	1.1A	—
DC-13 Control of electromagnets			5A	2A	—	1.1A	0.6A	—	

 For dimensions, see page 682.
Note 1. Except HW2B

LED Lamp Ratings (LSRD Type)

Rated Voltage	6V AC/DC	12V AC/DC	24V AC/DC	100/120V AC/DC	200/240V AC (50/60Hz sine wave)
Voltage Range	6V AC/DC ±10%	12V AC/DC ±10%	24V AC/DC ±10%	100/120V AC/DC ±10%	200/240V AC ±10%
Current Draw	DC	10mA	7mA	7mA	2mA
	AC	14mA	8mA	8mA	2mA
Part No.	LSRD-6	LSRD-1	LSRD-2	LSRD-H2	LSRD-M4
Life (reference value)	Approx. 50,000 hours (The luminance is reduced to 50% the initial intensity when used on complete DC at 25°C.)				

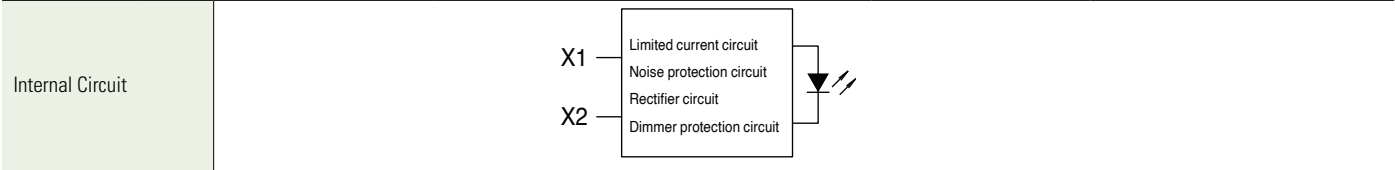

Non-Illuminated Round Pushbuttons (Assembled)



Function	Contacts	Round Flush		Round Extended	
		Plastic Bezel	Metal Bezel	Plastic Bezel	Metal Bezel
Momentary	Operator Only	HW1B-M1-①	HW4B-M1-①	HW1B-M2-①	HW4B-M2-①
	1NO	HW1B-M1F10-①	HW4B-M1F10-①	HW1B-M2F10-①	HW4B-M2F10-①
	1NC	HW1B-M1F01-①	HW4B-M1F01-①	HW1B-M2F01-①	HW4B-M2F01-①
	1NO-1NC	HW1B-M1F11-①	HW4B-M1F11-①	HW1B-M2F11-①	HW4B-M2F11-①
	2NO	HW1B-M1F20-①	HW4B-M1F20-①	HW1B-M2F20-①	HW4B-M2F20-①
	2NC	HW1B-M1F02-①	HW4B-M1F02-①	HW1B-M2F02-①	HW4B-M2F02-①
	2NO-2NC	HW1B-M1F22-①	HW4B-M1F22-①	HW1B-M2F22-①	HW4B-M2F22-①
Maintained	Operator Only	HW1B-A1-①	HW4B-A1-①	HW1B-A2-①	HW4B-A2-①
	1NO	HW1B-A1F10-①	HW4B-A1F10-①	HW1B-A2F10-①	HW4B-A2F10-①
	1NC	HW1B-A1F01-①	HW4B-A1F01-①	HW1B-A2F01-①	HW4B-A2F01-①
	1NO-1NC	HW1B-A1F11-①	HW4B-A1F11-①	HW1B-A2F11-①	HW4B-A2F11-①
	2NO	HW1B-A1F20-①	HW4B-A1F20-①	HW1B-A2F20-①	HW4B-A2F20-①
	2NC	HW1B-A1F02-①	HW4B-A1F02-①	HW1B-A2F02-①	HW4B-A2F02-①
	2NO-2NC	HW1B-A1F22-①	HW4B-A1F22-①	HW1B-A2F22-①	HW4B-A2F22-①

① Button Color Code

Color	Code
Black	B
Green	G
Red	R
Blue	S
White	W
Yellow	Y



1. In place of ①, specify the Button Color Code from table below.
2. For nameplates and accessories, see page 677 and 680.
3. For dimensions, see page 682.
4. For contact assembly part numbers, see page 682.
5. All assembled part numbers in catalog include standard, Finger-Safe (HW-U...) contacts.
6. Operator only models include operator plus button.
7. Additional contact configurations available (up to 6 total contacts).

Part Number Structure

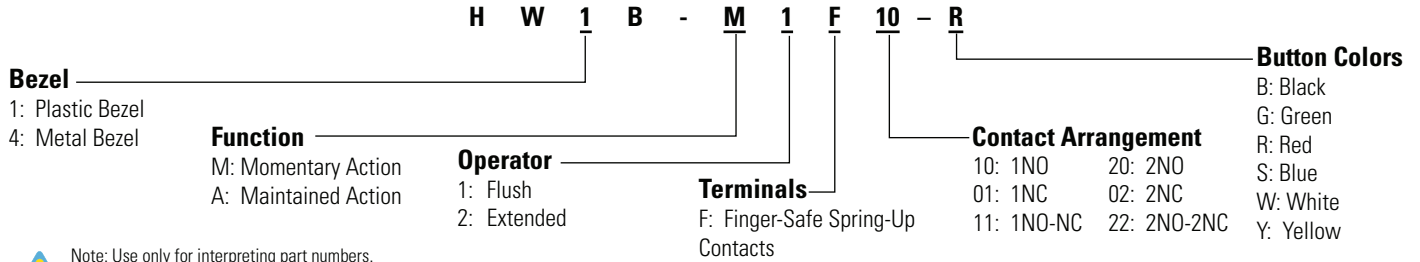

Note: Use only for interpreting part numbers. Do not use for developing part numbers.

Non-Illuminated Round Pushbuttons (Replacement Parts)

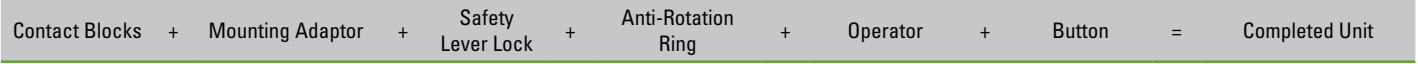

Contact Blocks

Style	Contacts	1NO	1NC
	Finger-Safe Spring-Up Terminal	HW-U10-F	HW-U01-F
		HW-U10R-F (early make)	HW-U01R-F (late break)
	Dummy Block	HW-DB	

Anti-Rotation Ring

Style	Part Number
	HW9Z-RL

Use with notched panel cutout to prevent unit rotation.

Buttons

Style	Part Number
Round Flush 	HW1A-B1-①
Round Extended 	HW1A-B2-①

1. In place of ①, specify the Button Color Code from table.

Contact Block Mounting Adaptor

Style	Part Number
	HW-CB2C

1. Used to mount contact blocks to operator.
2. IDEC strongly recommends using the safety lever lock to prevent heavy vibration or maintenance personnel from inadvertently unlocking contacts.

Operators

Style		Plastic Bezel	Metal Bezel
Round Flush/ Extended 	Momentary	HW1B-M0	HW4B-M0
	Maintained 	HW1B-A0	HW4B-A0

Safety Lever Lock

Style	Part Number
	HW9Z-LS

① Button Color Code

Color	Code
Black	B
Green	G
Red	R
Blue	S
White	W
Yellow	Y

Non-Illuminated Mushroom Head Pushbuttons (Assembled)



Function	Contacts	ø29mm Mushroom Head		ø40mm Mushroom Head	
		Plastic Bezel	Metal Bezel	Plastic Bezel	Metal Bezel
Momentary	Operator Only	HW1B-M3-①	HW4B-M3-①	HW1B-M4-①	HW4B-M4-①
	1NO	HW1B-M3F10-①	HW4B-M3F10-①	HW1B-M4F10-①	HW4B-M4F10-①
	1NC	HW1B-M3F01-①	HW4B-M3F01-①	HW1B-M4F01-①	HW4B-M4F01-①
	1NO-1NC	HW1B-M3F11-①	HW4B-M3F11-①	HW1B-M4F11-①	HW4B-M4F11-①
	2NO	HW1B-M3F20-①	HW4B-M3F20-①	HW1B-M4F20-①	HW4B-M4F20-①
	2NC	HW1B-M3F02-①	HW4B-M3F02-①	HW1B-M4F02-①	HW4B-M4F02-①
	2NO-2NC	HW1B-M3F22-①	HW4B-M3F22-①	HW1B-M4F22-①	HW4B-M4F22-①
Maintained	Operator Only	HW1B-A3-①	HW4B-A3-①	HW1B-A4-①	HW4B-A4-①
	1NO	HW1B-A3F10-①	HW4B-A3F10-①	HW1B-A4F10-①	HW4B-A4F10-①
	1NC	HW1B-A3F01-①	HW4B-A3F01-①	HW1B-A4F01-①	HW4B-A4F01-①
	1NO-1NC	HW1B-A3F11-①	HW4B-A3F11-①	HW1B-A4F11-①	HW4B-A4F11-①
	2NO	HW1B-A3F20-①	HW4B-A3F20-①	HW1B-A4F20-①	HW4B-A4F20-①
	2NC	HW1B-A3F02-①	HW4B-A3F02-①	HW1B-A4F02-①	HW4B-A4F02-①
	2NO-2NC	HW1B-A3F22-①	HW4B-A3F22-①	HW1B-A4F22-①	HW4B-A4F22-①



Function	Contacts	ø60mm Mushroom Head
		Plastic Bezel
Momentary	Operator Only	HW1B-M5-①*
	1NO	HW1B-M5F10-①*
	1NC	HW1B-M5F01-①*
	1NO-1NC	HW1B-M5F11-①*
	2NO	HW1B-M5F20-①*
	2NC	HW1B-M5F02-①*
	2NO-2NC	HW1B-M5F22-①*

① Button Color Code

Color	Code
Black	B
Green	G
Red	R
Blue	S
White	W
Yellow	Y



1. In place of ①, specify the Button Color Code from table.
2. *60mm mushroom available only in red, green, black, and yellow.
3. For nameplates and accessories, see page 677 and 680.
4. For dimensions, see page 682.
5. For contact assembly part numbers, see page 682.
6. All assembled part numbers in catalog include standard spring-up Finger-Safe (HW-U...) contacts.
7. Operator only models include operator plus button.
8. Additional contact configurations available (up to 6 total contacts).

Part Number Structure

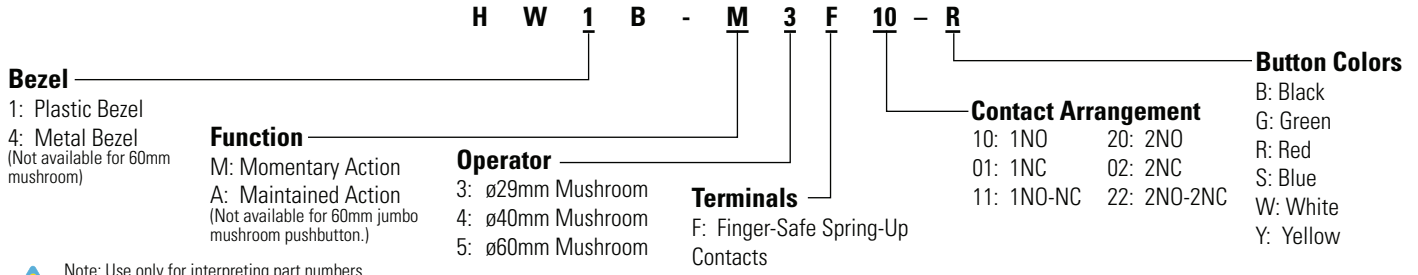

Note: Use only for interpreting part numbers. Do not use for developing part numbers.

Non-Illuminated Mushroom Head Pushbuttons (Replacement Parts)

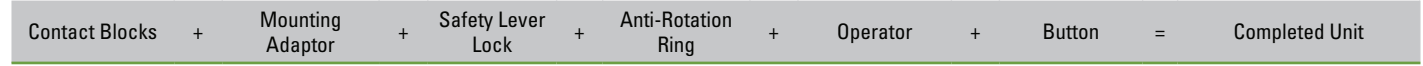

Contact Blocks

Style	Contacts	1NO	1NC
	Finger-Safe Spring-Up Terminal	HW-U10-F	HW-U01-F
		HW-U10R-F (early make)	HW-U01R-F (late break)
	Dummy Block	HW-DB	

Safety Lever Lock

Style	Part Number
	HW9Z-LS

Anti-Rotation Ring

Appearance	Part Number
	HW9Z-RL

Buttons

Style	Part Number
ø29mm Mushroom Cap	HW1A-B3-Ⓢ
ø40mm Mushroom Cap	HW1A-B4-Ⓢ

Contact Block Mounting Adaptor

Style	Part Number
	HW-CB2C

- Used to mount contact blocks to operator.
- IDEC strongly recommends using the safety lever lock to prevent heavy vibration or maintenance personnel from inadvertently unlocking contacts.

Operators

Style		Plastic Bezel	Metal Bezel
ø29mm Mushroom ø40mm Mushroom	Momentary	HW1B-M0L	HW4B-M0L
	Maintained	HW1B-A0L	HW4B-A0L
Ø60mm Jumbo Mushroom	Momentary	HW1B-M5-Ⓢ*	—

- *60mm mushroom operator includes non-removable button (available in red, black, green and yellow only).
- For nameplates and accessories, see page 677 and 680.
- For dimensions, see page 682.

1. In place of Ⓢ, specify the Button Color Code from table.

Ⓢ Button Color Code

Color	Code	Color	Code
Black	B	Blue	S
Green	G	White	W
Red	R	Yellow	Y

HW1B-M5 available only in black, red, green and yellow.

Non-Illuminated Square Pushbuttons (Assembled)

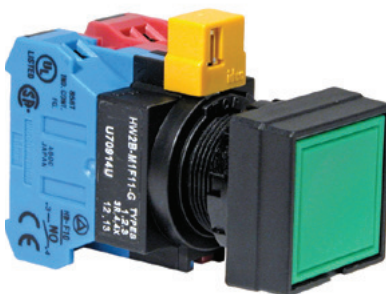

Function	Contacts	Square Flush	Square Extended
		Plastic Bezel	Plastic Bezel
Momentary	<i>Operator Only</i>	HW2B-M1-①	HW2B-M2-①
	1NO	HW2B-M1F10-①	HW2B-M2F10-①
	1NC	HW2B-M1F01-①	HW2B-M2F01-①
	1NO-1NC	HW2B-M1F11-①	HW2B-M2F11-①
	2NO	HW2B-M1F20-①	HW2B-M2F20-①
	2NC	HW2B-M1F02-①	HW2B-M2F02-①
	2NO-2NC	HW2B-M1F22-①	HW2B-M2F22-①
Maintained	<i>Operator Only</i>	HW2B-A1-①	HW2B-A2-①
	1NO	HW2B-A1F10-①	HW2B-A2F10-①
	1NC	HW2B-A1F01-①	HW2B-A2F01-①
	1NO-1NC	HW2B-A1F11-①	HW2B-A2F11-①
	2NO	HW2B-A1F20-①	HW2B-A2F20-①
	2NC	HW2B-A1F02-①	HW2B-A2F02-①
	2NO-2NC	HW2B-A1F22-①	HW2B-A2F22-①

① Button Color Code

Color	Code
Black	B
Green	G
Red	R
Blue	S
White	W
Yellow	Y



1. In place of ①, specify the Button Color Code from table.
2. For nameplates and accessories, see page 677 and 680.
3. For dimensions, see page 682.
4. For contact assembly part numbers, see page 682.
5. Square pushbuttons available in plastic bezel only.
6. All assembled part numbers in catalog include finger-safe spring-up (HW-U...) contacts.
7. Operator only model includes operator and button.
8. Additional contact configurations available (up to 6 total contacts).

Part Number Structure

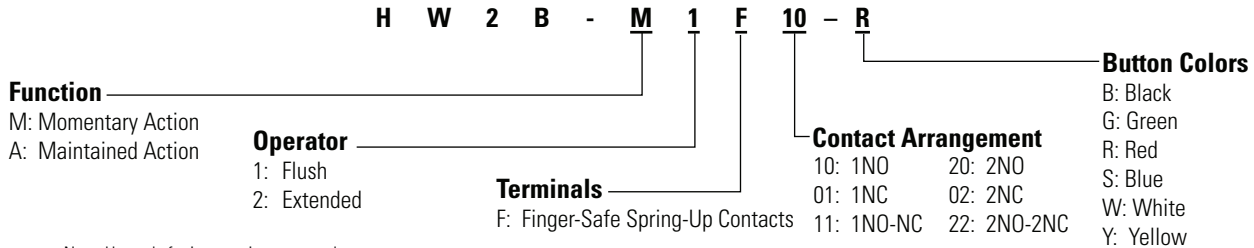

Note: Use only for interpreting part numbers. Do not use for developing part numbers.

Non-Illuminated Square Pushbuttons (Replacement Parts)

Contact Blocks + Mounting Adaptor + Safety Lever Lock + Anti-Rotation Ring + Operator + Button = Completed Unit



Contact Blocks

Style	Contacts	1NO	1NC
	Finger-Safe Spring-Up Terminal	HW-U10-F	HW-U01-F
		HW-U10R-F (early make)	HW-U01R-F (late break)
	Dummy Block	HW-DB	

Contact Block Mounting Adaptor

Style	Part Number
	HW-CB2C

1. Used to mount contact blocks to operator.
 2. IDEC strongly recommends using the safety lever lock to prevent heavy vibration or maintenance personnel from inadvertently unlocking contacts.

Safety Lever Lock

Style	Part Number
	HW9Z-LS

Anti-Rotation Ring

Appearance	Part Number
	HW9Z-RL

- Use with notched panel cutout to prevent unit rotation.

Operators

Style		Plastic Bezel
	Momentary	HW2B-M0
	Maintained	HW2B-A0

2. For nameplates and accessories, see pages 677 and 680.
 3. For dimensions, see page 682.

Buttons

Style	Part Number
Square Flush 	HW2A-B1-Ⓢ
Square Extended 	HW2A-B2-Ⓢ

1. In place of Ⓢ, specify the Button Color Code from table.

Ⓢ Button Color Code

Color	Code	Color	Code
Black	B	Blue	S
Green	G	White	W
Red	R	Yellow	Y

Non-Illuminated E-Stop Pushbuttons (Assembled)



Contacts	Ø29mm Head Pushlock Turn Reset		Ø40mm Head Pushlock Turn Reset	
	Plastic Bezel	Metal Bezel	Plastic Bezel	Metal Bezel
<i>Operator Only</i>	HW1B-V3Ⓞ†	HW4B-V3Ⓞ†	HW1B-V4Ⓞ†	HW4B-V4Ⓞ†
1NO	HW1B-V3F10-Ⓞ†	HW4B-V3F10-Ⓞ†	HW1B-V4F10-Ⓞ†	HW4B-V4F10-Ⓞ†
1NC	HW1B-V3F01-Ⓞ†	HW4B-V3F01-Ⓞ†	HW1B-V4F01-Ⓞ†	HW4B-V4F01-Ⓞ†
1NO-1NC	HW1B-V3F11-Ⓞ†	HW4B-V3F11-Ⓞ†	HW1B-V4F11-Ⓞ†	HW4B-V4F11-Ⓞ†
2NO	HW1B-V3F20-Ⓞ†	HW4B-V3F20-Ⓞ†	HW1B-V4F20-Ⓞ†	HW4B-V4F20-Ⓞ†
2NC	HW1B-V3F02-Ⓞ†	HW4B-V3F02-Ⓞ†	HW1B-V4F02-Ⓞ†	HW4B-V4F02-Ⓞ†



Contacts	Ø40mm Head EMO Pushlock Turn Reset		Ø40mm Head Pushlock Key Reset	
	Plastic Bezel	Metal Bezel	Plastic Bezel	Metal Bezel
<i>Operator Only</i>	HW1B-V4R-EMO-2*	HW4B-V4R-EMO-2*	HW1B-X4R*	HW4B-X4R*
1NO	HW1B-V4F10-R-EMO-2*	HW4B-V4F10-R-EMO-2*	HW1B-X4F10-R*	HW4B-X4F10-R*
1NC	HW1B-V4F01-R-EMO-2*	HW4B-V4F01-R-EMO-2*	HW1B-X4F01-R*	HW4B-X4F01-R*
1NO-1NC	HW1B-V4F11-R-EMO-2*	HW4B-V4F11-R-EMO-2*	HW1B-X4F11-R*	HW4B-X4F11-R*
2NO	HW1B-V4F20-R-EMO-2*	HW4B-V4F20-R-EMO-2*	HW1B-X4F20-R*	HW4B-X4F20-R*
2NC	HW1B-V4F02-R-EMO-2*	HW4B-V4F02-R-EMO-2*	HW1B-X4F02-R*	HW4B-X4F02-R*



- * Available in Red only.
- † Available in red or yellow. Insert color code in place of Ⓞ (R: Red, Y: Yellow).
- For accessories, see page 680.
- For dimensions, see page 682.
- For nameplates and shrouds, see page 682.
- For contact assembly part numbers, see page 682.
- All HW series E-stops comply with EN60947-5-5, the IEC "E-Stop Addendum to the Low Voltage Directive," this includes "tamper proof" operation whereby a change of contact state is not possible by "teasing" or "floating" the operator.
- All assembled part numbers in catalog include standard finger-safe spring-up (HW-U...) contacts.
- Operator only models include operator and button.
- Additional contact configurations available (up to 6 total contacts).

Contacts	ø60mm Head Pushlock Turn Reset
	Plastic Bezel
<i>Operator Only</i>	HW1B-V5R*
1NO	HW1B-V5F10-R*
1NC	HW1B-V5F01-R*
1NO-1NC	HW1B-V5F11-R*
2NO	HW1B-V5F20-R*
2NC	HW1B-V5F02-R*

Part Number Structure

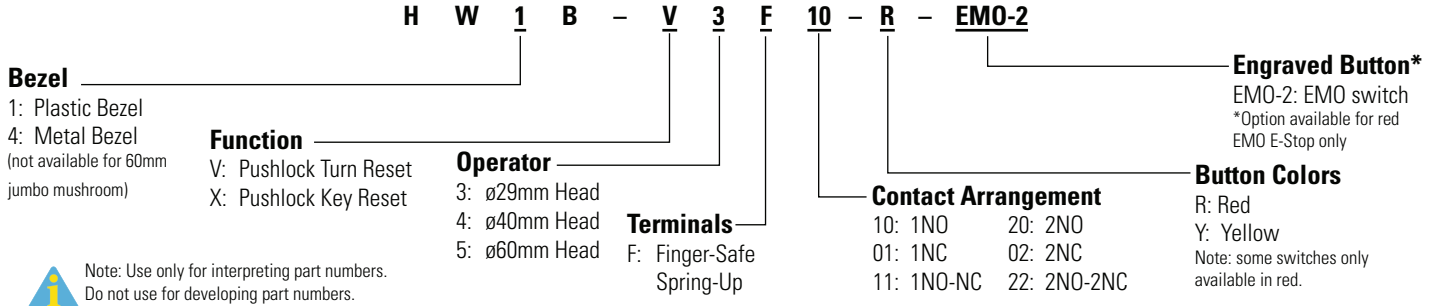

Non-Illuminated E-Stop Pushbuttons (Replacement Parts)

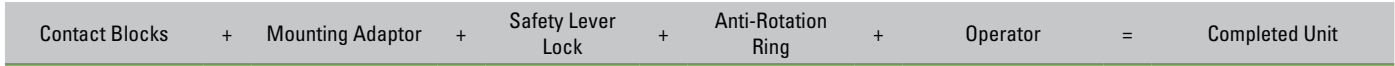

Contact Blocks

Style	Contacts	1NO	1NC
	Finger-Safe Spring-Up Terminal	HW-U10-F	HW-U01-F
		HW-U10R-F (early make)	HW-U01R-F (late break)
	Dummy Block	HW-DB	

Safety Lever Lock

Style	Part Number
	HW9Z-LS

Anti-Rotation Ring

Appearance	Part Number
	HW9Z-RL

Use with notched panel cutout to prevent unit rotation.

Contact Block Mounting Adaptor

Style	Part Number
	HW-CB2C

- Used to mount contact blocks to operator.
- IEDEC strongly recommends using the safety lever lock to prevent heavy vibration or maintenance personnel from inadvertently unlocking contacts.

Operators

Style	Plastic		Metal
	red	HW1B-V3R	HW4B-V3R
	yellow	HW1B-V3Y	HW4B-V3Y
	red	HW1B-V4R	HW4B-V4R
	yellow	HW1B-V4Y	HW4B-V4Y
	HW1B-V4R-EMO-2		HW4B-V4R-EMO-2
	HW1B-X4R		HW4B-X4R
	HW1B-V5R		-

- * Available in red only.
- All E-Stop buttons are not removable from the operator.

Note: Determine mounting centers to ensure proper spacing.

Push Pull & Unibody E-Stop Pushbuttons (Assembled)

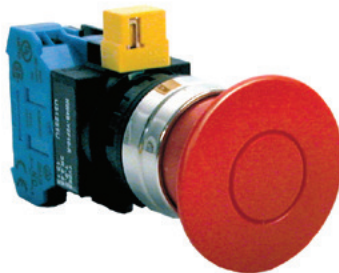

ø40mm Head Push-Pull

Contacts	Plastic Bezel	Metal Bezel
Operator Only (Red)	HW1B-Y2R	HW4B-Y2R
Operator Only (Yellow)	HW1B-Y2Y	HW4B-Y2Y
1NO	HW1B-Y2F10-Ⓢ†	HW4B-Y2F10-Ⓢ†
1NC	HW1B-Y2F01-Ⓢ†	HW4B-Y2F01-Ⓢ†
1NO-1NC	HW1B-Y2F11-Ⓢ†	HW4B-Y2F11-Ⓢ†
2NC	HW1B-Y2F02-Ⓢ†	HW4B-Y2F02-Ⓢ†
2NO	HW1B-Y2F20-Ⓢ†	HW4B-Y2F20-Ⓢ†

ø40mm Unibody Pushlock Turn Reset*

Contacts	Plastic Bezel
1NO-1NC	HW1E-BV4F11-R
2NC	HW1E-BV4F02-R
1NO-2NC*	HW1E-BV412R-TK2093-1



* NO contact is used as a monitoring contact

Unibody Illuminated E-Stops*

Contacts	LED
1NO-1NC	HW1E-LV4F11QD-R-Ⓢ
2NC	HW1E-LV4F02QD-R-Ⓢ
2NC (with push-on illumination)	HW1E-TV4F02QD-R-Ⓢ
1NO-1NC (with push-on illumination)	HW1E-TV4F11QD-R-Ⓢ

Ⓢ Full Voltage LED Code

Voltage	Code
6VAC/DC	6V
12VAC/DC	12V
24VAC/DC	24V
120V AC	120V
240V AC	240V

Terminal Numbering (Unibody only)

Models	Terminal Number
1NO-1NC	NO = 13/14, NC = 11/12
2NC	NC = 11/12, NC = 21/22
HW1E-L HW1E-T	LED + = X2, LED - = X1



- * Available in Red only.
- † Available in red or yellow. Insert color code in place of Ⓢ (R: Red, Y: Yellow).
- In place of Ⓢ, specify Full Voltage LED Code.
- With single unit construction, the positive action contacts are integrated in the body of the switch. This provides an extra degree of safety and reliability for critical emergency stop functions.
- In the illuminated version, the light is independent of the switch action (except push-on LED model).
- For accessories, see page 680.
- For dimensions, see page 682.
- For nameplates and shrouds, see page 680.
- For contact assembly part numbers, see page 680.
- All HW Series E-Stop operators include non-removable color caps.
- All HW series E-Stops comply with EN60947-5-5, the IEC "E-Stop Addendum to the Low Voltage Directive," this includes "tamper proof" operation whereby a change of contact state is not possible by "teasing" or "floating" the operator.
- All HW series E-Stop switches comply with SEMI S2 standards.
- All assembled part numbers in catalog include standard finger-safe spring-up (HW-U...) contacts.
- Additional contact configurations available (up to 6 total contacts).

Part Number Structure

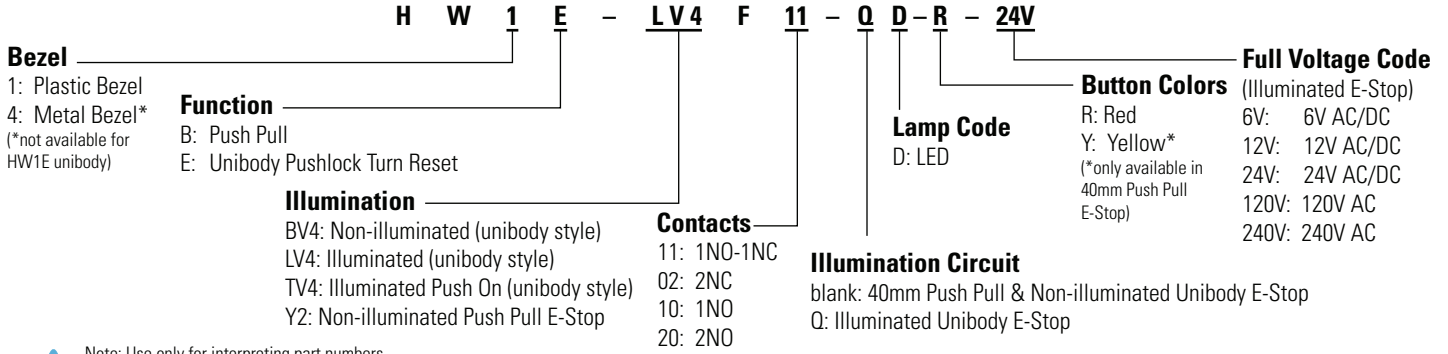

Note: Use only for interpreting part numbers. Do not use for developing part numbers.

Illuminated & Non-Illuminated E-Stop Pushbuttons (Replacement Parts)

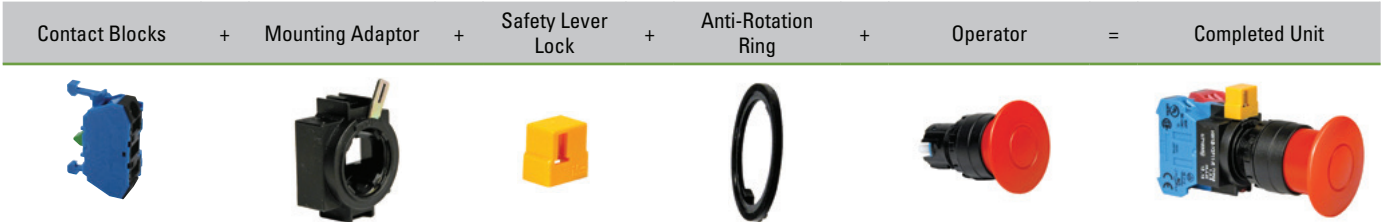

Contact Blocks

Style	Contacts	1NO	1NC
	Finger-Safe Spring-Up Terminal	HW-U10-F	HW-U01-F
		HW-U10R-F (early make)	HW-U01R-F (late break)
	Dummy Block	HW-DB	

- 1. There are no replacement parts for the HW1E unibody E-Stop.
- 2. For illuminated unibody E-Stop, see page 682 for replacement lens.

Contact Block Mounting Adaptor

Style	Part Number
	HW-CB2C

- 1. Used to mount contact blocks to operator.
- 2. IDEC strongly recommends using the safety lever lock to prevent heavy vibration or maintenance personnel from inadvertently unlocking contacts.

Safety Lever Lock

Style	Part Number
	HW9Z-LS

Anti-Rotation Ring

Appearance	Part Number
	HW9Z-RL

Use with notched panel cutout to prevent unit rotation.

Operators

Style	Part Number	
ø40mm Head Push-Pull	Plastic	HW1B-Y2R
	Metal	HW4B-Y2R
	Plastic	HW1B-Y2Y
	Metal	HW4B-Y2Y

All E-Stop Buttons are not removable from the operator.

E-Stop Stations



Contacts	29mm Pushlock Turn Reset		40mm Pushlock Turn Reset	
	Plastic Bezel	Metal Bezel	Plastic Bezel	Metal Bezel
1NO-1NC	FB1W-HW1B-V311R	FB1W-HW4B-V311R	FB1W-HW1B-V411R	FB1W-HW4B-V411R
2NC	FB1W-HW1B-V302R	FB1W-HW4B-V302R	FB1W-HW1B-V402R	FB1W-HW4B-V402R



Contacts	40mm Push-Pull Reset		40mm Pushlock Key Reset	
	Plastic Bezel	Metal Bezel	Plastic Bezel	Metal Bezel
1NO-1NC	FB1W-HW1B-Y211R	FB1W-HW4B-Y211R	FB1W-HW1B-X411R	FB1W-HW4B-X411R
2NC	FB1W-HW1B-Y202R	FB1W-HW4B-Y202R	FB1W-HW1B-X402R	FB1W-HW4B-X402R



Contacts	40mm EMO Pushlock Turn Reset	
	Plastic Bezel	Metal Bezel
1NO-1NC	FB1W-HW1B-V411R-EMO-2	FB1W-HW4B-V411R-EMO-2
2NC	FB1W-HW1B-V402R-EMO-2	FB1W-HW4B-V402R-EMO-2

- 1. Maximum of two contact blocks.
- 2. Box is supplied with yellow top and black bottom only.

Jumbo Dome Pilot Lights



Plastic Bezel

Actual Size



Jumbo Dome	LED	Operator Only	HW1P-500
		Full Voltage 24V AC/DC	HW1P-504-Ⓢ

- 1. In place of Ⓢ, specify the Lens/LED Color Code.
- 2. Spring-Up terminals with 24V LED.
- 3. For nameplates and accessories, see page 677 and 680.
- 4. For dimensions, see page 682.

Ⓢ Lens/LED Color Code

Color	Code
Amber	A
Green	G
Red	R
Blue	S
White	W
Yellow	Y

Jumbo Dome Replacement Parts

Item	Appearance	Description	Part Number
Lens		Polycarbonate Lens	HW1A-P5Ⓢ
LED Diffusing Lens			HW9Z-PP5C
LED Lamps		LED Lamp	LSTDB-2Ⓢ

- 1. In place of Ⓢ, specify the Lens/LED Color Code.
- 2. Use white LED for yellow lens.

Lamp Ratings

	Part Number	Operating Voltage	Rated Current	Power Consumption
LED	LSTDB-2	24V AC/DC ±10%	15mA	0.36W



Pilot Lights (Assembled)



		Round Flush		Dome	
		Plastic Bezel	Metal Bezel	Plastic Bezel	Metal Bezel
Operator Only		HW1P-1FQ0-②	HW4P-1FQ0-②	HW1P-2FQ0-②	HW4P-2FQ0-②
Full Voltage		HW1P-1FQD-②-③	HW4P-1FQD-②-③	HW1P-2FQD-②-③	HW4P-2FQD-②-③
Transformer	120V AC	HW1P-1FH2D-②	HW4P-1FH2D-②	HW1P-2FH2D-②	HW4P-2FH2D-②
	240V AC	HW1P-1FM4D-②	HW4P-1FM4D-②	HW1P-2FM4D-②	HW4P-2FM4D-②
	480V AC	HW1P-1FT8D-②	HW4P-1FT8D-②	HW1P-2FT8D-②	HW4P-2FT8D-②
DC-DC Converter*	110V DC	HW1P-1D2D-②	-	HW1P-2D2D-②	-



		Square Flush	
		Plastic Bezel	
Operator Only		HW2P-1FQ0-②	
Full Voltage		HW2P-1FQD-②-③	
Transformer	120V AC	HW2P-1FH2D-②	
	240V AC	HW2P-1FM4D-②	
	480V AC	HW2P-1FT8D-②	
DC-DC Converter*	110V DC	HW2P-1D2D-②	

 * DC-DC converter voltage input from 90-140V DC.

② Lens Color Code

Color	Code
Amber	A
Green	G
Red	R
Blue	S
White	W
Yellow	Y

③ LED Full Voltage Code

Voltage	Code
6VAC/DC	6V
12VAC/DC	12V
24VAC/DC	24V
120V AC/DC	120V
240V AC	240V



1. In place of ②, specify the Lens Color Code from table below.
2. In place of ③ specify the Full Voltage Code from table below.
3. For nameplates and accessories, see page 677 and 680.
4. For dimensions, see page 682.
5. **Pilot lights do not come with anti-rotation ring.**
6. Operator models come with operator and lens.
7. **Yellow pilot light comes with white LED.**

Part Number Structure

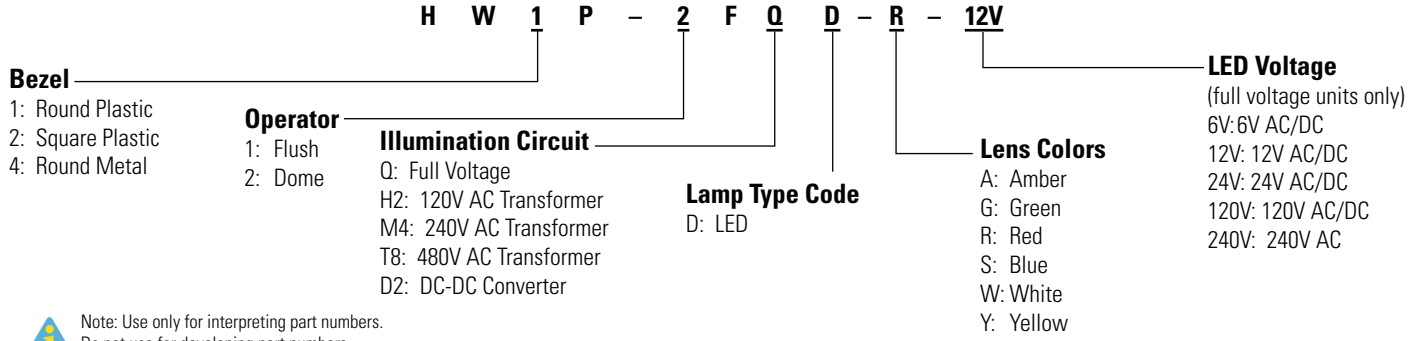

Pilot Lights (Replacement Parts)



(not applicable for full voltage units)

Transformer Units

Style	Voltage	Part Number
LED 	120V AC	HW-FH20
	240V AC	HW-FM40
	480V AC	HW-FT80
(6V secondary voltage)	110V DC†	HW-RD0*



- 1. *DC-DC converter can only be used with HW1P-100 and HW2P-100 operators
- 2. † DC-DC converter voltage input from 90-140V DC.

LED Lamps

Style	Voltage	Part Number
LED 	6V AC/DC	LSRD-6
	12V AC/DC	LSRD-1
	24V AC/DC	LSRD-2
	120V AC/DC	LSRD-H2
	240V AC	LSRD-M4

- 1. All LED lamps are white
- 2. The LED contains a current-limiting resistor and reverse polarity protection diodes.

Operators

Style	Type	Plastic Bezel	Metal Bezel
Round Flush 	Full Voltage	Finger-Safe	HW1P-1FQ0
	Transformer	Finger-Safe	HW1P-10
		Used for DC-DC convertor only	HW1P-100
Dome 	Full Voltage	Finger-Safe	HW1P-2FQ0
	Transformer	Finger-Safe	HW1P-20
		Used for DC-DC convertor only	HW1P-200
Square Flush 	Full Voltage	Finger-Safe	HW2P-1FQ0
	Transformer	Finger-Safe	HW2P-10
		Used for DC-DC convertor only	HW2P-100

- 1. Transformer type requires separate transformer & LED. Must select correct transformer bases. Use 6V LEDs.
- 2. Full voltage type only requires LED.

Lenses

Style	Part Number
Round/Flush 	HW1A-P1-Ⓢ-K
Dome 	HW1A-P2-Ⓢ-K
Square/Flush 	HW2A-P1-Ⓢ-K

In place of Ⓢ, specify the Lens Color Code.

③ Lens Color Code

Color	Code
Amber	A
Green	G
Red	R
Blue	S
White	W
Yellow	Y

For yellow lens use white LED.

Illuminated Round Pushbuttons (Assembled)

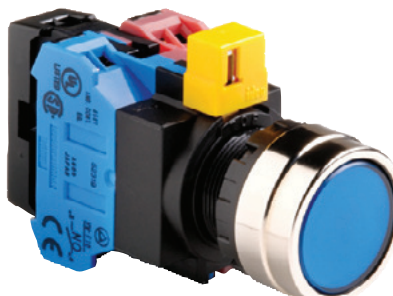

Illuminated Full Voltage Pushbuttons



Contacts	Flush		Extended		Extended w/ Full Shroud		
	Plastic Bezel	Metal Bezel	Plastic Bezel	Metal Bezel	Plastic Bezel	Metal Bezel	
Momentary	Operator Only	HW1L-M1-②	HW4L-M1-②	HW1L-M2-②	HW4L-M2-②	HW1L-MF2-②	HW4L-MF2-②
	1NO	HW1L-M1F10QD-②-③	HW4L-M1F10QD-②-③	HW1L-M2F10QD-②-③	HW4L-M2F10QD-②-③	HW1L-MF2F10QD-②-③	HW4L-MF2F10QD-②-③
	1NC	HW1L-M1F01QD-②-③	HW4L-M1F01QD-②-③	HW1L-M2F01QD-②-③	HW4L-M2F01QD-②-③	HW1L-MF2F01QD-②-③	HW4L-MF2F01QD-②-③
	1NO-1NC	HW1L-M1F11QD-②-③	HW4L-M1F11QD-②-③	HW1L-M2F11QD-②-③	HW4L-M2F11QD-②-③	HW1L-MF2F11QD-②-③	HW4L-MF2F11QD-②-③
	2NO	HW1L-M1F20QD-②-③	HW4L-M1F20QD-②-③	HW1L-M2F20QD-②-③	HW4L-M2F20QD-②-③	HW1L-MF2F20QD-②-③	HW4L-MF2F20QD-②-③
Maintained	Operator Only	HW1L-A1-②	HW4L-A1-②	HW1L-A2-②	HW4L-A2-②	HW1L-AF2-②	HW4L-AF2-②
	1NO	HW1L-A1F10QD-②-③	HW4L-A1F10QD-②-③	HW1L-A2F10QD-②-③	HW4L-A2F10QD-②-③	HW1L-AF2F10QD-②-③	HW4L-AF2F10QD-②-③
	1NC	HW1L-A1F01QD-②-③	HW4L-A1F01QD-②-③	HW1L-A2F01QD-②-③	HW4L-A2F01QD-②-③	HW1L-AF2F01QD-②-③	HW4L-AF2F01QD-②-③
	1NO-1NC	HW1L-A1F11QD-②-③	HW4L-A1F11QD-②-③	HW1L-A2F11QD-②-③	HW4L-A2F11QD-②-③	HW1L-AF2F11QD-②-③	HW4L-AF2F11QD-②-③
	2NO	HW1L-A1F20QD-②-③	HW4L-A1F20QD-②-③	HW1L-A2F20QD-②-③	HW4L-A2F20QD-②-③	HW1L-AF2F20QD-②-③	HW4L-AF2F20QD-②-③

Illuminated Transformer Pushbuttons



Contacts	Flush		Extended		Extended w/ Full Shroud		
	Plastic Bezel	Metal Bezel	Plastic Bezel	Metal Bezel	Plastic Bezel	Metal Bezel	
Momentary	Operator Only	HW1L-M1-②	HW4L-M1-②	HW1L-M2-②	HW4L-M2-②	HW1L-MF2-②	HW4L-MF2-②
	1NO-1NC	HW1L-M1F11-③D-②	HW4L-M1F11-③D-②	HW1L-M2F11-③D-②	HW4L-M2F11-③D-②	HW1L-MF2F11-③D-②	HW4L-MF2F11-③D-②
	2NO	HW1L-M1F20-③D-②	HW4L-M1F20-③D-②	HW1L-M2F20-③D-②	HW4L-M2F20-③D-②	HW1L-MF2F20-③D-②	HW4L-MF2F20-③D-②
Maintained	Operator Only	HW1L-A1-②	HW4L-A1-②	HW1L-A2-②	HW4L-A2-②	HW1L-AF2-②	HW4L-AF2-②
	1NO-1NC	HW1L-A1F11-③D-②	HW4L-A1F11-③D-②	HW1L-A2F11-③D-②	HW4L-A2F11-③D-②	HW1L-AF2F11-③D-②	HW4L-AF2F11-③D-②
	2NO	HW1L-A1F20-③D-②	HW4L-A1F20-③D-②	HW1L-A2F20-③D-②	HW4L-A2F20-③D-②	HW1L-AF2F20-③D-②	HW4L-AF2F20-③D-②

- In place of ②, specify Lens Color Code from table.
- In place of ③ specify Voltage Code from table.
- Light independent of switch position.
- For replacement part numbers, see page 648.
- For nameplates and accessories, see page 677 and 680.
- For dimensions, see page 682.
- For contact assembly part numbers, see page 682.
- Full voltage and transformer models use the same operator.
- Additional contact configurations available (up to 6 total contacts).
- 10. Yellow pushbutton comes with white LED.**

② Lens Color Code

Color	Code
Amber	A
Green	G
Red	R
Blue	S
White	W
Yellow	Y

③ Voltage Code

Full Voltage Models		Transformer Models	
Voltage	Code	Voltage	Code
6V AC/DC	6V	120V AC	H2
12V AC/DC	12V	240V AC	M4
24V AC/DC	24V	480V AC	T8
120V AC/DC	120V		
240V AC	240V		

Part Number Structure

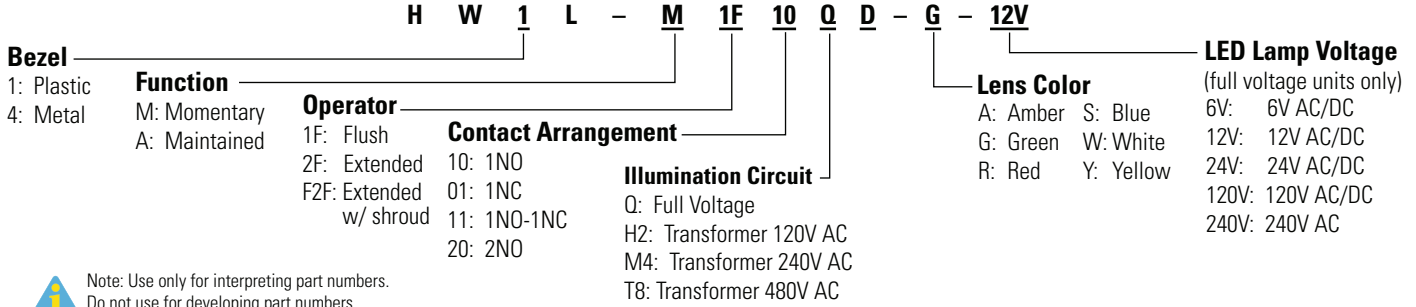

Illuminated Round Pushbuttons (Replacement Parts)



*Transformer not needed with full voltage models.

Lamp Circuit Components

Style	Description	Terminals	Part Number
Lead Holder	For use with HW-CBL on all illuminated pushbutton units. One required for each deck (pair) of contacts.		HW-LH3
Dummy Block with Full Voltage Adaptor	For use with odd number of contacts.	Finger-Safe	HW-DA1FBN
Full Voltage Adaptor	For use with even number of contacts.	Finger-Safe	TW-DA1FB
Transformer Unit (6V secondary voltage)	120VAC 240VAC 480VAC	Finger-Safe	TW-F126B TW-F246B TW-F486B
DC-DC Converter	110VDC		HW-L16D

- *With spring-up terminals - to use spring-up terminal type, must use transformer type operator designed for spring-up transformer.
- ** DC-DC converter voltage input from 90-140V DC.

Operators

Style	Plastic Bezel	Metal Bezel
Round Flush/Extended	Momentary	HW1L-M0 HW4L-M0
	Maintained	HW1L-A0 HW4L-A0
Extended with Full Shroud	Momentary	HW1L-MF0 HW4L-MF0
	Maintained	HW1L-AF0 HW4L-AF0

Contact Blocks

Style	Contacts	1NO	1NC
Finger-Safe Spring-Up Terminal		HW-U10-F HW-U10R-F (early make)	HW-U01-F HW-U01R-F (late break)

- All assembled part numbers in catalog include standard finger-safe spring-up (HW-U...) contacts.

Contact Block Mounting Adaptor

Style	Part Number
	HW-CBL

- Used to mount contact blocks to operator (first pair only).
- IEDEC strongly recommends using the safety lever lock to prevent heavy vibration or maintenance personnel from inadvertently unlocking contacts.

Safety Lever Lock

Style	Part Number
	HW9Z-LS

Lenses

Style	Part Number
Round Flush	HW1A-L1-⊙-K
Round Extended	HW1A-L2-⊙-K

In place of ⊙, specify the Lens Color Code from previous page.

Anti-Rotation Ring

Appearance	Part Number
	HW9Z-RL

Use with notched panel cutout to prevent unit rotation.

LED Lamps

Style	Voltage	Part Number
LED	6V AC/DC	LSRD-6
	12V AC/DC	LSRD-1
	24V AC/DC	LSRD-2
	120V AC/DC	LSRD-H2
	240V AC	LSRD-M4

- All LED lamps are white
- The LED contains a current-limiting resistor and reverse polarity protection diodes.

Illuminated Mushroom & Square Pushbuttons (Assembled)

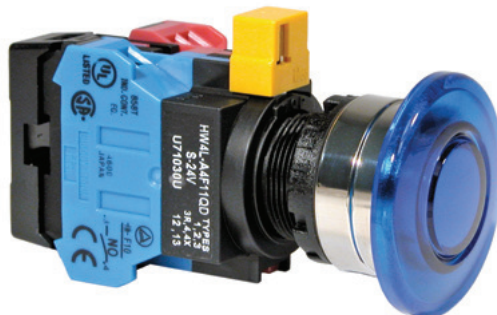

		40mm Mushroom Head		Square Flush	
		Contacts	Plastic Bezel	Metal Bezel	Plastic Bezel
Full Voltage	Momentary	<i>Operator Only</i> [†]	HW1L-M4-②	HW4L-M4-②	HW2L-M1-②
		1NO	HW1L-M4F10QD-②-③	HW4L-M4F10QD-②-③	HW2L-M1F10QD-②-③
		1NC	HW1L-M4F01QD-②-③	HW4L-M4F01QD-②-③	HW2L-M1F01QD-②-③
		1NO-1NC	HW1L-M4F11QD-②-③	HW4L-M4F11QD-②-③	HW2L-M1F11QD-②-③
		2NO	HW1L-M4F20QD-②-③	HW4L-M4F20QD-②-③	HW2L-M1F20QD-②-③
	Maintained	<i>Operator Only</i> [†]	HW1L-A4-②	HW4L-A4-②	HW2L-A1-②
		1NO	HW1L-A4F10QD-②-③	HW4L-A4F10QD-②-③	HW2L-A1F10QD-②-③
		1NC	HW1L-A4F01QD-②-③	HW4L-A4F01QD-②-③	HW2L-A1F01QD-②-③
		1NO-1NC	HW1L-A4F11QD-②-③	HW4L-A4F11QD-②-③	HW2L-A1F11QD-②-③
		2NO	HW1L-A4F20QD-②-③	HW4L-A4F20QD-②-③	HW2L-A1F20QD-②-③
Transformer	Momentary	1NO-1NC	HW1L-M4F11③D-②	HW4L-M4F11③D-②	HW2L-M1F11③D-②
		2NO	HW1L-M4F20③D-②	HW4L-M4F20③D-②	HW2L-M1F20③D-②
	Maintained	1NO-1NC	HW1L-A4F11③D-②	HW4L-A4F11③D-②	HW2L-A1F11③D-②
		2NO	HW1L-A4F20③D-②	HW4L-A4F20③D-②	HW2L-A1F20③D-②



- † Full voltage and transformer units use the same operator.
- In place of ②, specify the Lens Color Code from table.
- In place of ③ specify the Voltage Code from table.
- Light independent of switch position
- For nameplates and accessories, see page 677 and 680.
- For dimensions, see page 682.
- For contact assembly part numbers, see page 682.
- Additional contact configurations available (up to 6 total contacts).
- Yellow pushbutton comes with white LED.**

② Lens Color Code

Color	Code
Amber	A
Green	G
Red	R
Blue	S
White	W
Yellow	Y*



- * 40mm mushroom lenses not available in yellow.

③ Voltage Code

Full Voltage Models		Transformer Models	
Voltage	Code	Voltage	Code
6V AC/DC	6V	120V AC	H2
12V AC/DC	12V	240V AC	M4
24V AC/DC	24V	480V AC	T8
120V AC/DC	120V		
240V AC	240V		

Switches & Pilot Devices

Signaling Lights

Relays & Sockets

Timers

Contactors

Terminal Blocks

Circuit Breakers

Part Number Structure

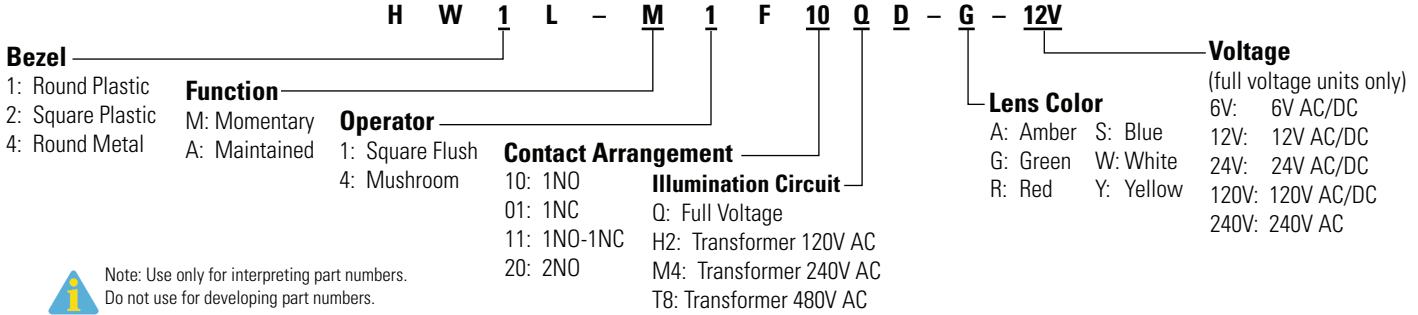

Illuminated Mushroom & Square Pushbuttons (Replacement Parts)

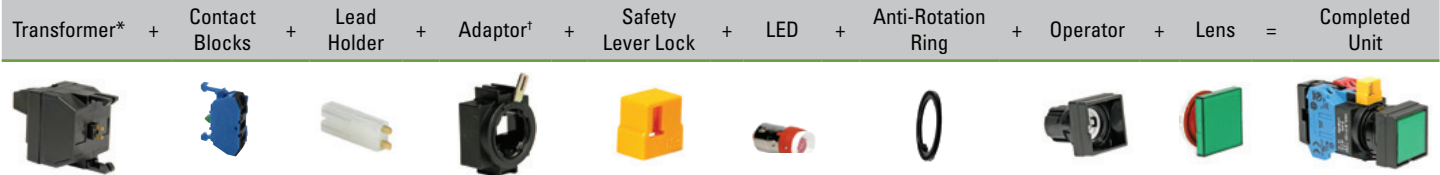

*Transformer not needed with full voltage models.

Lamp Circuit Components

Style	Description	Terminals	Part Number
Lead Holder	For use with HW-CBL on all illuminated pushbutton units. One required for each deck (pair) of contacts.		HW-LH3
Dummy Block with Full Voltage Adaptor	For use with odd number of contacts.	Finger-Safe	HW-DA1FBN
Full Voltage Adaptor	For use with even number of contacts.	Finger-Safe	TW-DA1FB
Transformer Unit (6V secondary voltage)	120VAC 240VAC 480VAC	Finger-Safe	TW-F126B TW-F246B TW-F486B
DC-DC Converter	110VDC		HW-L16D

- *With spring-up terminals - to use spring-up terminal type, must use transformer type operator designed for spring-up transformer.
- ** DC-DC converter voltage input from 90-140V DC.

Operators

Style			Plastic Bezel	Metal Bezel
ø40mm Mushroom		Momentary	HW1L-MOL	HW4L-MOL
		Maintained	HW1L-AOL	HW4L-AOL
Square		Momentary	HW2L-MO	-
		Maintained	HW2L-AO	-

Contact Blocks

Style	Contacts	1NO	1NC
	Finger-Safe Spring-Up Terminal	HW-U10-F HW-U10R-F (early make)	HW-U01-F HW-U01R-F (late break)

- All assembled part numbers in catalog include standard finger-safe spring-up contacts (HW-U...).

Contact Block Mounting Adaptor

Style	Part Number
	HW-CBL

- Used to mount contact blocks to operator (first pair only).
- IDECC strongly recommends using the safety lever lock to prevent heavy vibration or maintenance personnel from inadvertently unlocking contacts.

Anti-Rotation Ring

Appearance	Part Number
	HW9Z-RL

- Use with notched panel cutout to prevent unit rotation.

Safety Lever Lock

Style	Part Number
	HW9Z-LS

Lenses

Style	Part Number
ø40mm Mushroom Lens	ALW4BLU-⊙-K*
Square Flush	HW2A-L1-⊙-K

- In place of ⊙, specify the Lens Color Code.
- *Mushroom lens not available in yellow.

LED Lamps

Style	Voltage	Part Number
LED	6V AC/DC	LSRD-6
	12V AC/DC	LSRD-1
	24V AC/DC	LSRD-2
	120V AC/DC	LSRD-H2
	240V AC	LSRD-M4

- All LED lamps are white
- The LED contains a current-limiting resistor and reverse polarity protection diodes.

Selector Switches 2-Position (Assembled)



2-Position Selector Switches

Contact	Mounting	Operator Position		Handle	Maintained	Spring Return from Right
		L	R			
<i>Operator Only</i>				<i>Knob Lever</i>	<i>HW</i> Ⓢ-2T <i>HW</i> Ⓢ-2L	<i>HW</i> Ⓢ-21T <i>HW</i> Ⓢ-21L
1NO	1	0	X	Knob Lever	HWⓈ-2TF10 HWⓈ-2LF10	HWⓈ-21TF10 HWⓈ-21LF10
1NO- 1NC	1 2	0 X	X 0	Knob Lever	HWⓈ-2TF11 HWⓈ-2LF11	HWⓈ-21TF11 HWⓈ-21LF11
2NO	1 2	0 0	X X	Knob Lever	HWⓈ-2TF20 HWⓈ-2LF20	HWⓈ-21TF20 HWⓈ-21LF20
2NO- 2NC	1 2 3 4	0 X 0 X	X 0 X 0	Knob Lever	HWⓈ-2TF22 HWⓈ-2LF22	HWⓈ-21TF22 HWⓈ-21LF22



1. In place of Ⓢ enter 1 for plastic bezel or 4 for metal bezel.
2. For nameplates, see page 677.
3. All assembled part numbers in catalog include standard finger-safe spring-up (HW-U...) contacts.
4. Standard color for knob and lever is black.
5. Optional colors available for lever type. Must order in components. See next page for part numbers.
6. Additional contact configurations available (up to 6 total contacts).
7. For Truth Tables see page 690.

Ⓢ Bezel Type

Type	Code
Plastic	1
Metal	4

Part Number Structure

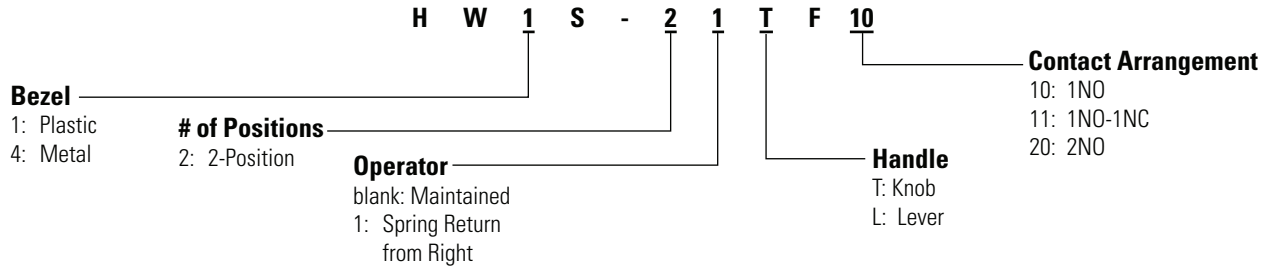

Note: Use only for interpreting part numbers. Do not use for developing part numbers.

Selector Switches 2-Position (Replacement Parts)

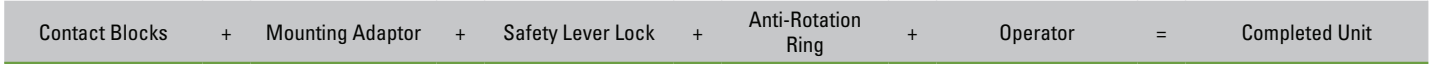

Contact Blocks

Style	Contacts	1NO	1NC
	Finger-Safe Spring-Up Terminal	HW-U10-F	HW-U01-F
		HW-U10R-F (early make)	HW-U01R-F (late break)
	Dummy Block	HW-DB	

Anti-Rotation Ring

Style	Part Number
	HW9Z-RL

Use with notched panel cutout to prevent unit rotation.

Operators

Style	Description	Handle	Plastic Bezel	Metal Bezel
	Maintained	Knob	HW1S-2T	HW4S-2T
		Lever	HW1S-2	HW4S-2
	Spring Return from Right	Knob	HW1S-21T	HW4S-21T
		Lever	HW1S-21	HW4S-21

1. Knob operator comes with black handle.
2. To order lever type, lever and inserts must be ordered separately, along with lever operator. See part numbers below.

Contact Block Mounting Adaptor

Style	Part Number
	HW-CB2C

1. Used to mount contact blocks to operator (first pair only).
2. IDEC strongly recommends using the safety lever lock to prevent heavy vibration or maintenance personnel from inadvertently unlocking contacts.

Safety Lever Lock

Style	Part Number
	HW9Z-LS

Levers & Inserts

Style	Part Number
	ASWHHL-⊕
	TW-HC1-⊕

Standard lever color is black. Standard insert color is white.

① Handle/Insert Color Code

Color	Code
Black*	B
Blue	S
Green	G
Red	R
Yellow	Y
White†	W

1. * Lever color inserts not available in black.
2. †Lever not available in white.

Selector Switches 3-Position (Assembled)



3-Position Selector Switches

Contact	Mounting	Operator Position			Handle	Maintained	Spring Return from Right	Spring Return from Left	Spring Return Two-Way
		L	C	R					
<i>Operator Only</i>					<i>Knob Lever</i>	<i>HW⊙S-3T* HW⊙S-3L</i>	<i>HW⊙S-31T HW⊙S-31L</i>	<i>HW⊙S-32T HW⊙S-32L</i>	<i>HW⊙S-33T HW⊙S-33L</i>
1NO- 1NC	1 2	0 0	X 0	X X	Knob Lever	HW⊙S-3TF11 HW⊙S-3LF11	HW⊙S-31TF11 HW⊙S-31LF11	HW⊙S-32TF11 HW⊙S-32LF11	HW⊙S-33TF11 HW⊙S-33LF11
2NO	1 2	X 0	0 0	0 X	Knob Lever	HW⊙S-3TF20 HW⊙S-3LF20	HW⊙S-31TF20 HW⊙S-31LF20	HW⊙S-32TF20 HW⊙S-32LF20	HW⊙S-33TF20 HW⊙S-33LF20
2NC	1 2	0 X	X X	X 0	Knob Lever	HW⊙S-3TF02 HW⊙S-3LF02	HW⊙S-31TF02 HW⊙S-31LF02	HW⊙S-32TF02 HW⊙S-32LF02	HW⊙S-33TF02 HW⊙S-33LF02
2NO- 1NC	1 2 3	X 0 0	0 0 X	0 X 0	Knob	HW⊙S-3JTF21N1	—	—	—
2NO- 2NC	1 2 3 4	X 0 0 X	0 0 X X	0 X X 0	Knob	HW⊙S-3TF22	HW⊙S-31TF22	HW⊙S-32TF22	HW⊙S-33TF22
2NO- 2NC	1 2 3 4	0 X X 0	0 X X 0	X 0 0 X	Knob	HW⊙S-3STF22N9	—	—	—
4NO	1 2 3 4	X 0 X 0	0 0 0 0	0 X 0 X	Knob	HW⊙S-3TF40	HW⊙S-31TF40	HW⊙S-32TF40	HW⊙S-33TF40
4NO	1 2 3 4	X 0 X 0	0 X 0 0	0 X 0 X	Knob	HW⊙S-3STF40N2	—	—	—
4NC	1 2 3 4	0 X 0 X	X X X X	X 0 X 0	Knob	HW⊙S-3TF04	HW⊙S-31TF04	HW⊙S-32TF04	HW⊙S-33TF04

⊙ Bezel Type

Type	Code
Plastic	1
Metal	4



- In place of ⊙ enter 1 for plastic bezel or 4 for metal bezel.
- Knob operator includes black knob/lever operator includes black lever.
- * Three position operator is available with three different cams.
HW⊙S-3T: Maintained (standard cam)
HW⊙S-3ST: Maintained (S cam)
HW⊙S-3JT: Maintained (J cam)
- Operator cams are color coded (white=standard cam, red=S cam, black=J cam).
- For nameplates, see page 677.
- For contact assembly part numbers, see page 682.
- All assembled part numbers in catalog include standard finger-safe spring-up (HW-U...) contacts.
- Standard color for knob and lever is black.
- Optional colors available for lever type. Must order in components. See next page for part numbers.
- Additional contact configurations available (up to 6 total contacts).
- For Truth Tables see page 690.

Part Number Structure

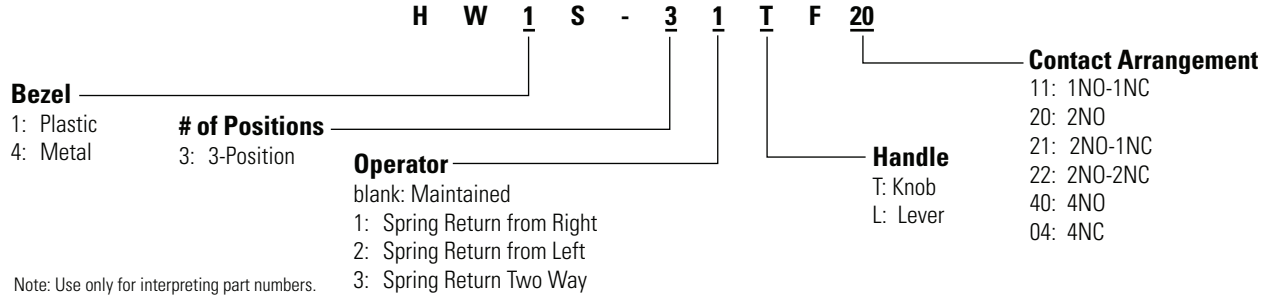

Selector Switches 3-Position (Replacement Parts)



Contact Blocks

Style	Contacts	1NO	1NC
	Finger-Safe Spring-Up Terminal	HW-U10-F	HW-U01-F
		HW-U10R-F (early make)	HW-U01R-F (late break)
	Dummy Block	HW-DB	

Anti-Rotation Ring

Style	Part Number
	HW9Z-RL

Use with notched panel cutout to prevent unit rotation.

Operators

Style	Description	Handle	Plastic Bezel	Metal Bezel
	Maintained (standard cam)	Knob	HW1S-3T	HW4S-3T
		Lever	HW1S-3	HW4S-3
	Maintained (S cam)	Knob	HW1S-3ST	HW4S-3ST
		Knob	HW1S-3JT	HW4S-3JT
	Spring Return from Right (standard cam)	Knob	HW1S-31T	HW4S-31T
		Lever	HW1S-31	HW4S-31
	Spring Return from Left (standard cam)	Knob	HW1S-32T	HW4S-32T
		Lever	HW1S-32	HW4S-32
	2-Way Spring Return (standard cam)	Knob	HW1S-33T	HW4S-33T
		Lever	HW1S-33	HW4S-33

- 1. Knob operator comes with black handle.
- 2. Three position knob operator is available with three different cams.
- 3. Operator cams are color coded (white=standard cam, red=S cam, black=J cam).
- 4. To order lever type, lever and inserts must be ordered separately, along with lever operator. See part numbers below.

Contact Block Mounting Adaptor

Style	Part Number
	HW-CB2C

- 1. Used to mount contact blocks to operator (first pair only).
- 2. IDEC strongly recommends using the safety lever lock to prevent heavy vibration or maintenance personnel from inadvertently unlocking contacts.

Safety Lever Lock

Style	Part Number
	HW9Z-LS

Levers & Inserts

Style	Part Number
	ASWHHL-①
	TW-HC1-①

Standard lever color is black. Standard insert color is white.

① Handle/Insert Color Code

Color	Code
Black*	B
Blue	S
Green	G
Red	R
Yellow	Y
White [†]	W

- 1. * Lever color inserts not available in black.
- 2. [†]Lever not available in white.

Selector Switches 4- & 5-Position (Assembled)

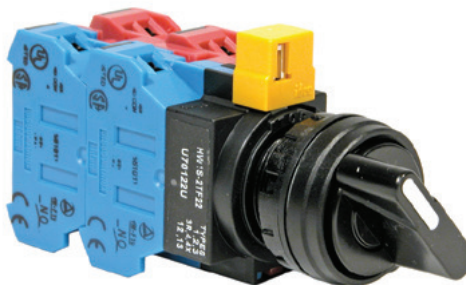

4-Position Selector Switches

Contact	Mounting	Operator Position				Handle	Maintained
		1	2	3	4		
<i>Operator Only</i>						<i>Knob Lever</i>	HWⓈS-4T HWⓈS-4L
1NO- 2NC	1	X	0	0	0	<i>Knob Lever</i>	HWⓈS-4TF12 HWⓈS-4LF12
	2	0	X	0	0		
	3	0	0	X	0		
	4	0	0	0	0		
1NO- 3NC	1	0	X	X	X	<i>Knob Lever</i>	HWⓈS-4TF13N6 HWⓈS-4LF13N6
	2	0	X	0	0		
	3	0	0	X	0		
	4	0	0	0	X		
2NO- 2NC	1	X	0	0	0	<i>Knob Lever</i>	HWⓈS-4TF22N3 HWⓈS-4LF22N3
	2	0	X	0	0		
	3	0	0	X	0		
	4	0	0	0	X		

5-Position Selector Switch

Contact	Mounting	Operator Position					Handle	Maintained
		1	2	3	4	5		
<i>Operator Only</i>						<i>Knob Lever</i>	HWⓈS-5T HWⓈS-5L	
2NO- 2NC	1	X	0	0	0	0	<i>Knob Lever</i>	HWⓈS-5TF22N3 HWⓈS-5LF22N3
	2	0	X	0	0	0		
	3	0	0	0	X	0		
	4	0	0	0	0	X		



1. In place of Ⓢ enter 1 for plastic bezel or 4 for metal bezel.
2. Knob operator includes black knob/lever operator includes black lever.
3. For nameplates, see page 677.
4. For contact assembly part numbers, see page 682.
5. Five position circuit cannot be made to make five independent contact closures.
6. All assembled part numbers in catalog include standard finger-safe spring-up (HW-U...) contacts.
7. Standard color for knob and lever is black.
8. Optional colors available for lever type. Must order in components. See next page for part numbers.
9. Additional contact configurations available (up to 6 total contacts).
10. For Truth Tables see page 690.

Ⓢ Bezel Type

Type	Code
Plastic	1
Metal	4

Part Number Structure

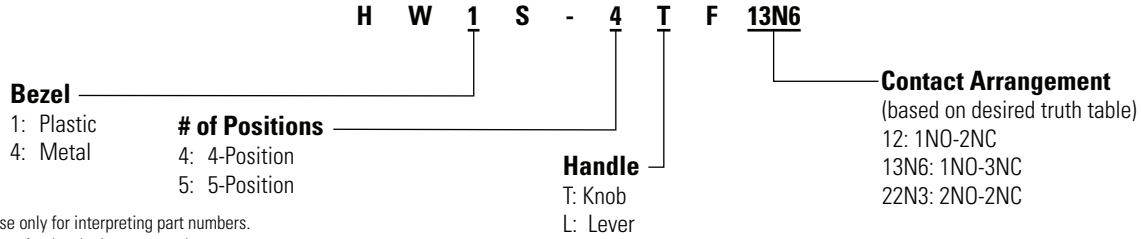

Note: Use only for interpreting part numbers. Do not use for developing part numbers.

Selector Switches 4- & 5-Position (Replacement Parts)



Contact Blocks

Style	Contacts	1NO	1NC
	Finger-Safe	HW-U10-F	HW-U01-F
	Spring-Up Terminal	HW-U10R-F (early make)	HW-U01R-F (late break)
	Dummy Block	HW-DB	

Anti-Rotation Ring

Style	Part Number
	HW9Z-RL

Use with notched panel cutout to prevent unit rotation.

Operators

Style	Position	Description	Handle	Plastic Bezel	Metal Bezel
	4	Maintained	Knob	HW1S-4T	HW4S-4T
			Lever	HW1S-4	HW4S-4
	5	Maintained	Knob	HW1S-5T	HW4S-5T
			Lever	HW1S-5	HW4S-5

1. Knob operator comes with black handle.
2. To order lever type, lever and inserts must be ordered separately, along with lever operator. See part numbers below.

Contact Block Mounting Adaptor

Style	Part Number
	HW-CB2C

1. Used to mount contact blocks to operator (first pair only).
2. IDEC strongly recommends using the safety lever lock to prevent heavy vibration or maintenance personnel from inadvertently unlocking contacts.

Safety Lever Lock

Style	Part Number
	HW9Z-LS

Levers & Inserts

Style	Part Number
	ASWHHL-⓪
	TW-HC1-⓪

Standard lever color is black. Standard insert color is white.

① Handle/Insert Color Code

Color	Code
Black*	B
Blue	S
Green	G
Red	R
Yellow	Y
White†	W

1. * Lever color inserts not available in black.
2. †Lever not available in white.

Key Switches 2-Position (Assembled)

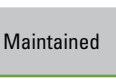
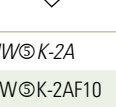

2-Position Key Switches

Contact	Mounting	Operator Position		Maintained	Spring Return from Right
		L	R	L 	L 
<i>Operator Only</i>				HWⓈK-2A	HWⓈK-21B
1NO	1	0	X	HWⓈK-2AF10	HWⓈK-21BF10
1NO-1NC	1	0	X	HWⓈK-2AF11	HWⓈK-21BF11
	2	X	0		
2NO	1	0	X	HWⓈK-2AF20	HWⓈK-21BF20
	2	0	X		
2NO-2NC	1	0	X	HWⓈK-2AF22	HWⓈK-21BF22
	2	X	0		
	3	0	X		
	4	X	0		

-  1. In place of Ⓢ enter 1 for plastic bezel or 4 for metal bezel.
 2. Key is removable in all maintained positions. Other key removable options available.
 3. Two keys are supplied with all switches.
 4. All standard operators are keyed alike.
 5. Other key removable options available. See table below.
 6. For nameplates, see page 677.
 7. For contact assembly part numbers, see page 682.
 8. Key is retained in "Spring Return" position.
 9. All assembled part numbers in catalog include finger-safe spring-up (HW-U...) contacts.
 10. Additional contact configurations available (up to 6 total contacts).
 11. For Truth Tables see page 682.

Ⓢ Bezel Type

Type	Code
Plastic	1
Metal	4

Key Removable Option Codes

Code	Description
A	Key not retained in any position (removable in all positions)
B	Key retained in right position only (removable LEFT)
C	Key retained in left position only (removable RIGHT)

Part Number Structure

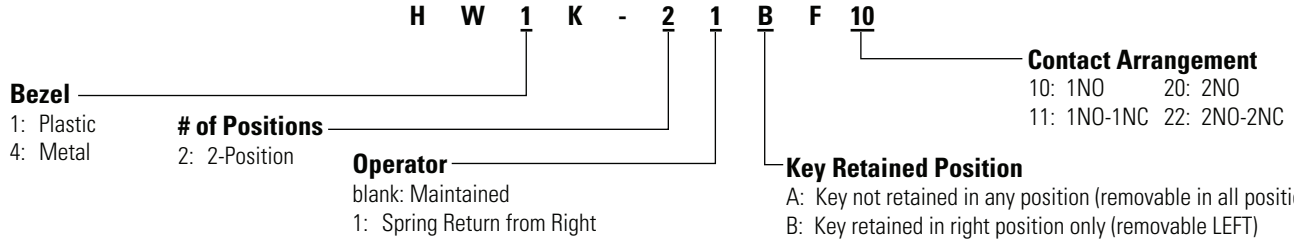

Note: Use only for interpreting part numbers. Do not use for developing part numbers.

Key Switches 2-Position (Replacement Parts)

Contact Assembly + Mounting Adaptor + Safety Lever Lock + Anti-Rotation Ring + Operator = Completed Unit



Contact Blocks

Style	Contacts	1NO	1NC
	Finger-Safe	HW-U10-F	HW-U01-F
	Spring-Up Terminal	HW-U10R-F (early make)	HW-U01R-F (late break)
	Dummy Block	HW-DB	

Safety Lever Lock

Style	Part Number
	HW9Z-LS

Anti-Rotation Ring

Style	Part Number
	HW9Z-RL

Use with notched panel cutout to prevent unit rotation.

Contact Block Mounting Adaptor

Style	Part Number
	HW-CB2C

1. Used to mount contact blocks to operator (first pair only).
2. IDEC strongly recommends using the safety lever lock to prevent heavy vibration or maintenance personnel from inadvertently unlocking contacts.

Operators

Style	Description	Plastic Bezel	Metal Bezel
	Maintained	HW1K-2A	HW4K-2A
	Maintained, key removed left only	HW1K-2B	HW4K-2B
	Spring Return from Right	HW1K-21B	HW4K-21B
	Maintained, key removed right only	HW1K-2C	HW4K-2C

1. Operator includes two keys.
2. All standard operators are keyed alike.

Key Switches 3-Position (Assembled)



3-Position Key Switches

Contact	Mounting	Operator Position			Maintained	Spring Return from Right	Spring Return from Left	Spring Return Two Way
		L	C	R				
<i>Operator Only</i>					HW⊙K-3A*	HW⊙K-31B	HW⊙K-32C	HW⊙K-33D
1NO-1NC	1	0	X	X	HW⊙K-3AF11	HW⊙K-31BF11	HW⊙K-32CF11	HW⊙K-33DF11
	2	0	0	X				
2NO	1	X	0	0	HW⊙K-3AF20	HW⊙K-31BF20	HW⊙K-32CF20	HW⊙K-33DF20
	2	0	0	X				
2NC	1	0	X	X	HW⊙K-3AF02	HW⊙K-31BF02	HW⊙K-32CF02	HW⊙K-33DF02
	2	X	X	0				
2NO-1NC	1	X	0	0	HW⊙K-3JAF21N1	-	-	-
	2	0	0	X				
	3	0	X	0				
2NO-2NC	1	X	0	0	HW⊙K-3AF22	HW⊙K-31BF22	HW⊙K-32CF22	HW⊙K-33DF22
	2	0	0	X				
	3	0	X	X				
	4	X	X	0				
2NO-2NC	1	0	0	X	HW⊙K-3SAF22N9	-	-	-
	2	X	0	0				
	3	X	X	0				
	4	0	0	X				
4NO	1	X	0	0	HW⊙K-3AF40	HW⊙K-31BF40	HW⊙K-32CF40	HW⊙K-33DF40
	2	0	0	X				
	3	X	0	0				
	4	0	0	X				
4NO	1	X	0	0	HW⊙K-3SAF40N2	-	-	-
	2	0	X	X				
	3	X	0	0				
	4	0	0	X				
4NC	1	0	X	X	HW⊙K-3AF04	HW⊙K-31BF04	HW⊙K-32CF04	HW⊙K-33DF04
	2	X	X	0				
	3	0	X	X				
	4	X	X	0				

Ⓢ Bezel Type

Type	Code
Plastic	1
Metal	4





- In place of ⊙ enter 1 for plastic bezel or 4 for metal bezel.
- Key is removable in all maintained positions. Other key removable options available.
- Two keys are supplied with all switches.
- All standard operators are keyed alike.
- Other key removable options available. See table to the right.
- * Operator is available with three different cams.
HW⊙K-3A: Maintained (standard cam)
HW⊙K-3SA: Maintained (Cam S)
HW⊙K-3JA: Maintained (Cam J)
- For nameplates, see page 677.
- For contact assembly part numbers, see page 682.
- All assembled part numbers in catalog include standard Finger-Safe spring-up (HW-U...) contacts.
- Additional contact configurations available (up to 6 total contacts).
- For Truth Tables see page 690.

Key Removable Option Codes

Code	Description
A	Key not retained in any position (removable in all positions)
B	Key retained in right position only
C	Key retained in left position only
D	Key retained in left and right (3 position only)
E	Key retained in center only (3 position only)
G	Key retained right and center (3 position only)
H	Key retained left and center (3 position only)

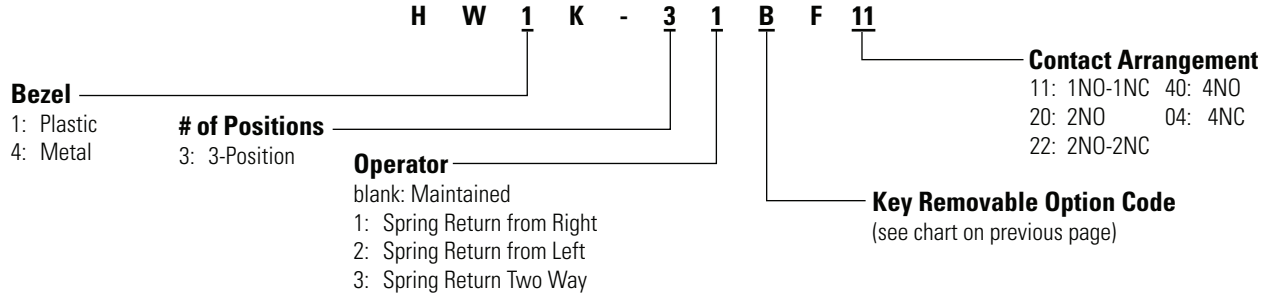
Part Number Structure





 Note: Use only for interpreting part numbers. Do not use for developing part numbers.

Key Switches 3-Position (Replacement Parts)

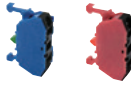

Contact Blocks

Style	Contacts	1NO	1NC
	Finger-Safe Spring-Up Terminal	HW-U10-F	HW-U01-F
		HW-U10R-F (early make)	HW-U01R-F (late break)
	Dummy Block	HW-DB	

Safety Lever Lock

Style	Part Number
	HW9Z-LS

Anti-Rotation Ring

Style	Part Number
	HW9Z-RL

 Use with notched panel cutout to prevent unit rotation.

Contact Block Mounting Adaptor

Style	Part Number
	HW-CB2C

-  1. Used to mount contact blocks to operator (first pair only).
2. IDEC strongly recommends using the safety lever lock to prevent heavy vibration or maintenance personnel from inadvertently unlocking contacts.

Operators

Style	Description	Plastic Bezel	Metal Bezel
	Maintained (standard cam)	HW1K-3A	HW4K-3A
	Maintained (S cam)	HW1K-3SA	HW4K-3SA
	Maintained (J cam)	HW1K-3JA	HW4K-3JA
	Spring Return from Right (standard cam)	HW1K-31B	HW4K-31B
	Spring Return from Left (standard cam)	HW1K-32C	HW4K-32C
	2-Way Spring Return (standard cam)	HW1K-33D	HW4K-33D

-  1. Operator includes two keys.
2. All standard operators are keyed alike.
3. Other key removable options available. See table on previous page.
4. Key not removable from spring-returned position

Illuminated Selector Switches 2-Position (Assembled)



2-Position Illuminated Selector Switches

Contact	Mounting	Style		Part Number			
		Operator Position		Maintained	Spring Return from Right		
		L	R	L	R		
<i>Operator Only</i>				HW⊙F-2②	HW⊙F-21②		
1NO-1NC	1 2	0 X	X 0	Full Voltage	HW⊙F-2F11QD-②-③	HW⊙F-21F11QD-②-③	
				Transformer	120V	HW⊙F-2F11H2D-②	HW⊙F-21F11H2D-②
					240V 480V	HW⊙F-2F11M4D-② HW⊙F-2F11T8D-②	HW⊙F-21F11M4D-② HW⊙F-21F11T8D-②
2NO	1 2	X 0	0 X	Full Voltage	HW⊙F-2F20QD-②-③	HW⊙F-21F20QD-②-③	
				Transformer	120V	HW⊙F-2F20H2D-②	HW⊙F-21F20H2D-②
					240V 480V	HW⊙F-2F20M4D-② HW⊙F-2F20T8D-②	HW⊙F-21F20M4D-② HW⊙F-21F20T8D-②
2NO-2NC	1 2 3 4	0 X 0 X	X 0 X 0	Full Voltage	HW⊙F-2F22QD-②-③	HW⊙F-21F22QD-②-③	
				Transformer	120V	HW⊙F-2F22H2D-②	HW⊙F-21F22H2D-②
					240V 480V	HW⊙F-2F22M4D-② HW⊙F-2F22T8D-②	HW⊙F-21F22M4D-② HW⊙F-21F22T8D-②



- In place of ⊙ specify Lens color code.
- In place of ⊙ specify Full Voltage code.
- In place of ⊙ enter 1 for plastic bezel or 4 for metal bezel.
- For nameplates, see page 677.
- For contact assembly part numbers, see page 682.
- Light is independent of switch position.
- All assembled part numbers in catalog include standard Finger-Safe spring-up (HW-U...) contacts.
- Yellow selector switch comes with white LED.**
- Additional contact configurations available (up to 6 total contacts).
- For Truth Tables see page 690.

② Lens Color Code

Color	Code
Amber	A
Green	G
Red	R
Blue	S
White	W
Yellow	Y

③ Full Voltage Code

Full Voltage Models	
Voltage	Code
6VAC/DC	6V
12VAC/DC	12V
24VAC/DC	24V
120V AC/DC	120V
240V AC	240V

⑤ Bezel Code

Type	Code
Plastic	1
Metal	4

Part Number Structure

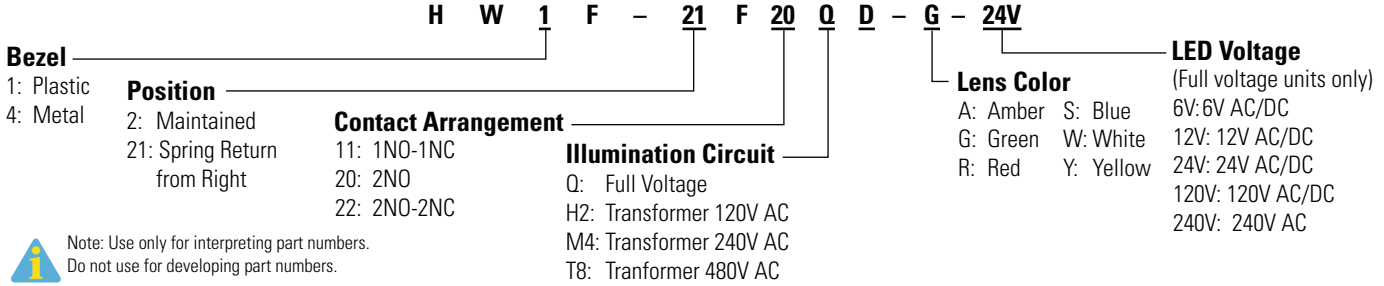

Illuminated Selector Switches 2-Position (Replacement Parts)

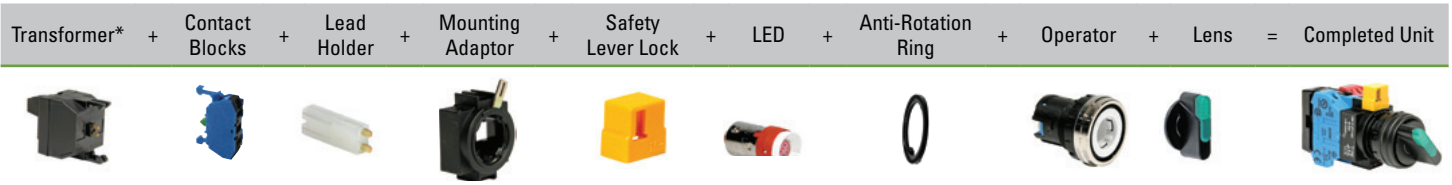

*Transformer not needed with full voltage models.

Lamp Circuit Components

Style	Description	Terminals	Part Number
	For use with HW-CBL on all illuminated pushbutton units. One required for each deck (pair) of contacts.		HW-LH3
	For use with odd number of contacts.	Finger-Safe	HW-DA1FBN
	For use with even number of contacts.	Finger-Safe	TW-DA1FB
	120VAC 240VAC 480VAC	Finger-Safe	TW-F126B TW-F246B TW-F486B
	110VDC		HW-L16D

- DC-DC convertor features spring-up terminals.
- DC-DC convertor applicable voltage range 90-140V DC.

Operators

Style	Description	Plastic Bezel	Metal Bezel
	Maintained	HW1F-2	HW4F-2
	Spring return from right	HW1F-21	HW4F-21

Illuminated knobs must be ordered separately.

Contact Blocks

Style	Contacts	1NO	1NC
	Finger-Safe Spring-Up Terminal	HW-U10-F HW-U10R-F (early make)	HW-U01-F HW-U01R-F (late break)

Contact Block Mounting Adaptor

Style	Part Number
	HW-CBL

- Used to mount contact blocks to operator (first pair only).
- IEEC strongly recommends using the safety lever lock to prevent heavy vibration or maintenance personnel from inadvertently unlocking contacts.

Safety Lever Lock

Style	Part Number
	HW9Z-LS

Illuminated Knob

Appearance	Part Number
	HW9Z-FDY-⊙-K

In place of ⊙, specify the Color Code.

⊙ Lens Color Code

Color	Code	Color	Code
Amber	A	Blue	S
Green	G	White	W
Red	R	Yellow	Y

Anti-Rotation Ring

Style	Part Number
	HW9Z-RL

Use with notched panel cutout to prevent unit rotation.

LED Lamps

Style	Voltage	Part Number
	6V AC/DC	LSRD-6
	12V AC/DC	LSRD-1
	24V AC/DC	LSRD-2
	120V AC/DC	LSRD-H2
	240V AC	LSRD-M4

- All LED lamps are white
- The LED contains a current-limiting resistor and reverse polarity protection diodes.

Illuminated Selector Switches 3-Position (Assembled)



3-Position Illuminated Selector Switches

Contact	Mounting	Style			Part Number				
		Operator Position			Type	Maintained	Spring Return from Right	Spring Return from Left	Spring Return Two-Way
		L	C	R					
<i>Operator Only</i>						HW⊙F-3⊙	HW⊙F-31⊙	HW⊙F-32⊙	HW⊙F-33⊙
1NO-1NC	1 2	0	X	X	Full Voltage	HW⊙F-3F11QD-⊙-⊙	HW⊙F-3F11QD-⊙-⊙	HW⊙F-3F11QD-⊙-⊙	HW⊙F-3F11QD-⊙-⊙
		0	0	X	Transformer	120V HW⊙F-3F11H2D-⊙	120V HW⊙F-3F11H2D-⊙	120V HW⊙F-3F11H2D-⊙	120V HW⊙F-3F11H2D-⊙
		0	0	240V HW⊙F-3F11M4D-⊙		240V HW⊙F-3F11M4D-⊙	240V HW⊙F-3F11M4D-⊙	240V HW⊙F-3F11M4D-⊙	
0	0	X	480V HW⊙F-3F11T8D-⊙	480V HW⊙F-3F11T8D-⊙	480V HW⊙F-3F11T8D-⊙	480V HW⊙F-3F11T8D-⊙	480V HW⊙F-3F11T8D-⊙		
2NO	1 2	X	0	0	Full Voltage	HW⊙F-3F20QD-⊙-⊙	HW⊙F-3F20QD-⊙-⊙	HW⊙F-3F20QD-⊙-⊙	HW⊙F-3F20QD-⊙-⊙
		0	0	X	Transformer	120V HW⊙F-3F20H2D-⊙	120V HW⊙F-3F20H2D-⊙	120V HW⊙F-3F20H2D-⊙	120V HW⊙F-3F20H2D-⊙
		0	0	240V HW⊙F-3F20M4D-⊙		240V HW⊙F-3F20M4D-⊙	240V HW⊙F-3F20M4D-⊙	240V HW⊙F-3F20M4D-⊙	
0	0	X	480V HW⊙F-3F20T8D-⊙	480V HW⊙F-3F20T8D-⊙	480V HW⊙F-3F20T8D-⊙	480V HW⊙F-3F20T8D-⊙	480V HW⊙F-3F20T8D-⊙		
2NC	1 2	0	X	X	Full Voltage	HW⊙F-3F02QD-⊙-⊙	HW⊙F-3F02QD-⊙-⊙	HW⊙F-3F02QD-⊙-⊙	HW⊙F-3F02QD-⊙-⊙
		X	X	0	Transformer	120V HW⊙F-3F02H2D-⊙	120V HW⊙F-3F02H2D-⊙	120V HW⊙F-3F02H2D-⊙	120V HW⊙F-3F02H2D-⊙
		X	X	240V HW⊙F-3F02M4D-⊙		240V HW⊙F-3F02M4D-⊙	240V HW⊙F-3F02M4D-⊙	240V HW⊙F-3F02M4D-⊙	
X	X	0	480V HW⊙F-3F02T8D-⊙	480V HW⊙F-3F02T8D-⊙	480V HW⊙F-3F02T8D-⊙	480V HW⊙F-3F02T8D-⊙	480V HW⊙F-3F02T8D-⊙		
2NO-2NC	1 2 3 4	X	0	0	Full Voltage	HW⊙F-3F22QD-⊙-⊙	HW⊙F-3F22QD-⊙-⊙	HW⊙F-3F22QD-⊙-⊙	HW⊙F-3F22QD-⊙-⊙
		0	0	X	Transformer	120V HW⊙F-3F22H2D-⊙	120V HW⊙F-3F22H2D-⊙	120V HW⊙F-3F22H2D-⊙	120V HW⊙F-3F22H2D-⊙
		0	X	240V HW⊙F-3F22M4D-⊙		240V HW⊙F-3F22M4D-⊙	240V HW⊙F-3F22M4D-⊙	240V HW⊙F-3F22M4D-⊙	
X	X	0	480V HW⊙F-3F22T8D-⊙	480V HW⊙F-3F22T8D-⊙	480V HW⊙F-3F22T8D-⊙	480V HW⊙F-3F22T8D-⊙	480V HW⊙F-3F22T8D-⊙		
4NO	1 2 3 4	X	0	0	Full Voltage	HW⊙F-3F40QD-⊙-⊙	HW⊙F-3F40QD-⊙-⊙	HW⊙F-3F40QD-⊙-⊙	HW⊙F-3F40QD-⊙-⊙
		0	0	X	Transformer	120V HW⊙F-3F40H2D-⊙	120V HW⊙F-3F40H2D-⊙	120V HW⊙F-3F40H2D-⊙	120V HW⊙F-3F40H2D-⊙
		X	0	240V HW⊙F-3F40M4D-⊙		240V HW⊙F-3F40M4D-⊙	240V HW⊙F-3F40M4D-⊙	240V HW⊙F-3F40M4D-⊙	
0	0	X	480V HW⊙F-3F40T8D-⊙	480V HW⊙F-3F40T8D-⊙	480V HW⊙F-3F40T8D-⊙	480V HW⊙F-3F40T8D-⊙	480V HW⊙F-3F40T8D-⊙		
4NC	1 2 3 4	0	X	X	Full Voltage	HW⊙F-3F04QD-⊙-⊙	HW⊙F-3F04QD-⊙-⊙	HW⊙F-3F04QD-⊙-⊙	HW⊙F-3F04QD-⊙-⊙
		X	X	0	Transformer	120V HW⊙F-3F04H2D-⊙	120V HW⊙F-3F04H2D-⊙	120V HW⊙F-3F04H2D-⊙	120V HW⊙F-3F04H2D-⊙
		0	X	240V HW⊙F-3F04M4D-⊙		240V HW⊙F-3F04M4D-⊙	240V HW⊙F-3F04M4D-⊙	240V HW⊙F-3F04M4D-⊙	
X	X	0	480V HW⊙F-3F04T8D-⊙	480V HW⊙F-3F04T8D-⊙	480V HW⊙F-3F04T8D-⊙	480V HW⊙F-3F04T8D-⊙	480V HW⊙F-3F04T8D-⊙		



- In place of ⊙ specify Lens color code.
- In place of ⊙ specify Full Voltage code.
- In place of ⊙ enter 1 for plastic bezel or 4 for metal bezel.
- For nameplates, see page 677.
- For contact assembly part numbers, see page 682.
- Light is independent of switch position.
- All assembled part numbers in catalog include standard Finger-Safe spring-up (HW-U..) contacts.

8. Yellow selector switch comes with white LED.

- Additional contact configurations available (up to 6 total contacts).
- For Truth Tables see page 690.

⊙ Lens Color

Color	Code
Amber	A
Green	G
Red	R
Blue	S
White	W
Yellow	Y

⊙ Full Voltage Code

Full Voltage Models	
Voltage	Code
6VAC/DC	6V
12VAC/DC	12V
24VAC/DC	24V
120V AC/DC	120V
240V AC	240V

⊙ Bezel Code

Type	Code
Plastic	1
Metal	4

Switches & Pilot Devices

Signaling Lights

Relays & Sockets

Timers

Contactors

Terminal Blocks

Circuit Breakers

Part Number Structure

H W 1 F - 31 F 20 Q D - G - 24V

Bezel
1: Plastic
4: Metal

Position
3: Maintained
31: Spring Return from Right
32: Spring Return from Left
33: Spring Return 2-Way

Contact Arrangement
11: 1NO-1NC 22: 2NO-2NC
20: 2NO 40: 4NO
02: 2NC 04: 4NC

Illumination Circuit
Q: Full Voltage
H2: Transformer 120V AC
M4: Transformer 240V AC
T8: Transformer 480V AC

Lens Color
A: Amber S: Blue
G: Green W: White
R: Red Y: Yellow

Full Voltage Code
6V: 6V AC/DC
12V: 12V AC/DC
24V: 24V AC/DC
120V: 120V AC/DC
240V: 240V AC

Note: Use only for interpreting part numbers. Do not use for developing part numbers.

Illuminated Selector Switches 3-Position (Replacement Parts)

Transformer* + Contact Blocks + Lead Holder + Mounting Adaptor + Safety Lever Lock + LED + Anti-Rotation Ring + Operator + Lens = Completed Unit



*Transformer not needed with full voltage models.

Lamp Circuit Components

Style	Description	Terminals	Part Number
Lead Holder	For use with HW-CBL on all illuminated pushbutton units. One required for each deck (pair) of contacts.		HW-LH3
Dummy Block with Full Voltage Adaptor	For use with odd number of contacts.	Finger-Safe	HW-DA1FBN
Full Voltage Adaptor	For use with even number of contacts.	Finger-Safe	TW-DA1FB
Transformer Unit (6V secondary voltage)	120VAC 240VAC 480VAC	Finger-Safe	TW-F126B TW-F246B TW-F486B
DC-DC Converter	110VDC		HW-L16D

- DC-DC converter features spring-up terminals.
- DC-DC converter applicable voltage range 90-140V DC.

Operators

Style	Description	Plastic Bezel	Metal Bezel
	Maintained	HW1F-3	HW4F-3
	Spring return from right	HW1F-31	HW4F-31
	Spring return from left	HW1F-32	HW4F-32
	2-Way spring return	HW1F-33	HW4F-33

Illuminated knobs must be ordered separately.

Contact Blocks

Style	Contacts	1NO	1NC
Finger-Safe Spring-Up Terminal		HW-U10-F HW-U10R-F (early make)	HW-U01-F HW-U01R-F (late break)

Contact Block Mounting Adaptor

Style	Part Number
	HW-CBL

- Used to mount contact blocks to operator (first pair only).
- IEEC strongly recommends using the safety lever lock to prevent heavy vibration or maintenance personnel from inadvertently unlocking contacts.

Safety Lever Lock

Style	Part Number
	HW9Z-LS

Illuminated Knob

Appearance	Part Number
	HW9Z-FDY-⊙-K

In place of ⊙, specify the Color Code.

⊙ Lens Color Code

Color	Code	Color	Code
Amber	A	Blue	S
Green	G	White	W
Red	R	Yellow	Y

Anti-Rotation Ring

Style	Part Number
	HW9Z-RL

Use with notched panel cutout to prevent unit rotation.

LED Lamps

Style	Voltage	Part Number
LED	6V AC/DC	LSRD-6
	12V AC/DC	LSRD-1
	24V AC/DC	LSRD-2
	120V AC/DC	LSRD-H2
	240V AC	LSRD-M4

- All LED lamps are white
- The LED contains a current-limiting resistor and reverse polarity protection diodes.

Mono Lever Switches 2-Position (Assembled)



2-Position Mono Lever Switches

Style	Part Number	Description
HW1M Standard Lever	HW1M-F1010-20	Maintained up and down
	HW1M-F2020-20	Spring return up and down
	HW1M-F1010-40	Maintained up and down
	HW1M-F2020-40	Spring return up and down
	HW1M-F0101-20	Maintained right and left
	HW1M-F0202-20	Spring return right and left
	HW1M-F0101-40	Maintained right and left
	HW1M-F0202-40	Spring return right and left
HW1M-L Interlocking Lever	HW1M-LF1010-20	Maintained up and down
	HW1M-LF2020-20	Spring return up and down
	HW1M-LF1010-40	Maintained up and down
	HW1M-LF2020-40	Spring return up and down
	HW1M-LF0101-20	Maintained right and left
	HW1M-LF0202-20	Spring return right and left
	HW1M-LF0101-40	Maintained right and left
	HW1M-LF0202-40	Spring return right and left

 All Assembled units with Finger-Safe spring-up (HW-U...) contacts

Circuit Diagrams

2 Position Left/Right

Circuit Number	Contact Mounting		Position		
	No.		Left	Center	Right
20	1	HW-U10-F	X	0	0
	2	HW-U10-F	0	0	X
40	1	HW-U10-F	X	0	0
	2	HW-U10-F	0	0	X
	3	HW-U10-F	X	0	0
	4	HW-U10-F	0	0	X

2 Position Up/Down

Circuit Number	Contact Mounting		Position		
	No.		Down	Center	Up
20	1	HW-U10-F	X	0	0
	2	HW-U10-F	0	0	X
40	1	HW-U10-F	X	0	0
	2	HW-U10-F	0	0	X
	3	HW-U10-F	X	0	0
	4	HW-U10-F	0	0	X

Part Number Structure

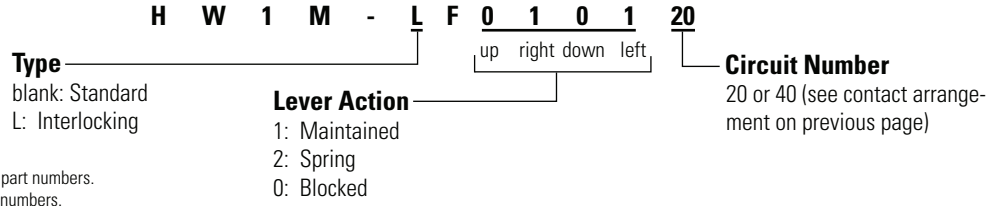

Note: Use only for interpreting part numbers. Do not use for developing part numbers.

Mono Lever Switches 2-Position (Sub-assembled) Part Numbers



Contact Blocks

Style	Contacts	1NO	1NC
	Finger-Safe	HW-U10-F	HW-U01-F
	Spring-Up Terminal	HW-U10R-F (early make)	HW-U01R-F (late break)
	Dummy Block	HW-DB	

Anti-Rotation Ring

Style	Part Number
	HW9Z-RL

Use with notched panel cutout to prevent unit rotation.

Operators

Style	Description	Part Number
	Maintained Up/Down	HW1M-1010
	Spring return Up/Down	HW1M-2020
	Maintained Left/Right	HW1M-0101
	Spring return Left/Right	HW1M-0202
	Maintained Up/Down	HW1M-L1010
	Spring return Up/Down	HW1M-L2020
	Maintained Left/Right	HW1M-L0101
	Spring return Left/Right	HW1M-L0202

Contact Block Mounting Adaptor

Style	Part Number
	HW-CB2C

1. Used to mount contact blocks to operator (first pair only).
 2. IDEC strongly recommends using the safety lever lock (included) to prevent heavy vibration or maintenance personnel from inadvertently unlocking contacts.

Safety Lever Lock

Style	Part Number
	HW9Z-LS

Replacement Parts

Item	Part Number
Black Cap	 HW9Z-CPM
Boot	
	HW9Z-BLM (fits standard operator only)

Mono Lever Switches 3- & 4-Position (Assembled)



3-Position

Style	Part Number	Description
HW1M Standard Lever	HW1M-F0121-12N3	Maintained right and left, spring return down
	HW1M-F0222-12N3	Spring return right, down, left
HW1M-L Interlocking Lever	HW1M-LF0121-12N3	Maintained right and left, spring return down
	HW1M-LF0222-12N3	Spring return right, down, left

Circuit Diagram

Circuit Number	Contact Mounting		Position				
	No.		Down	Left	Center	Up	Right
12N3	1	HW-U01-F	0	0	0	0	X
	2	HW-U01-F	X	0	0	0	0
	3	HW-U10-F	0	X	0	0	0

4-Position

Style	Part Number	Description
HW1M Standard Lever	HW1M-F1111-22N9	Maintained all positions
	HW1M-F1212-22N9	Maintained up and down, spring left and right
	HW1M-2121-22N9	Spring up and down, maintained left and right
	HW1M-2222-22N9	Spring return all positions
HW1M-L Interlocking Lever	HW1M-LF1111-22N9	Maintained all positions
	HW1M-LF1212-22N9	Maintained up and down, spring left and right
	HW1M-LF2121-22N9	Spring up and down, maintained left and right
	HW1M-LF2222-22N9	Spring return all positions

Circuit Diagram

Circuit Number	Contact Mounting		Position				
	No.		Down	Left	Center	Up	Right
22N9	1	HW-U01-F	0	0	0	0	X
	2	HW-U01-F	X	0	0	0	0
	3	HW-U10-F	0	X	0	0	0
	4	HW-U10-F	0	0	0	X	0



All assembled part numbers in catalog include Finger-Safe spring-up (HW-U...) contacts.

Part Number Structure

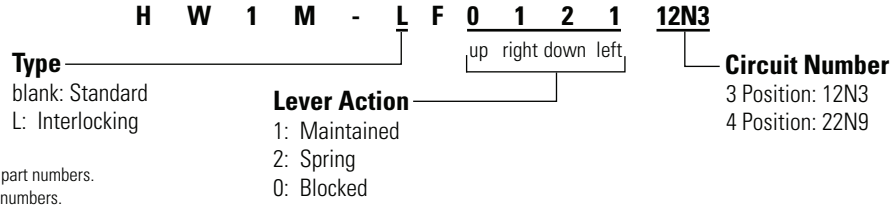

Note: Use only for interpreting part numbers. Do not use for developing part numbers.

Mono Lever Switches 3 & 4-Position (Sub-assembled) Part Numbers



Contact Blocks

Style	Contacts	1NO	1NC
	Finger-Safe Spring-Up Terminal	HW-U10-F	HW-U01-F
		HW-U10R-F (early make)	HW-U01R-F (late break)
	Dummy Block	HW-DB	

Anti-Rotation Ring

Style	Part Number
	HW9Z-RL

Use with notched panel cutout to prevent unit rotation.

Operators

Style	Description	Part Number
	Standard	
	Combination, 3 position	HW1M-0121
	Spring return, 3 position	HW1M-0222
	Maintained, 4 position	HW1M-1111
	Combination, 4 position	HW1M-1212
	Combination, 4 position	HW1M-2121
	Spring return, 4 position	HW1M-2222
	Combination, 3 position	HW1M-L0121
	Spring return, 3 position	HW1M-L0222
	Maintained, 4 position	HW1M-L1111
	Combination, 4 position	HW1M-L1212
	Combination, 4 position	HW1M-L2121
	Spring return, 4 position	HW1M-L2222

Contact Block Mounting Adaptor

Style	Part Number
	HW-CB2C

1. Used to mount contact blocks to operator (first pair only).
 2. IDEC strongly recommends using the safety lever lock (included) to prevent heavy vibration or maintenance personnel from inadvertently unlocking contacts.

Safety Lever Lock

Style	Part Number
	HW9Z-LS

Replacement Parts

Item	Part Number
Black Cap	
	HW9Z-CPM
Boot	
	HW9Z-BLM (fits standard operator only)

Pushbutton Selectors (Assembled)



2-Position Pushbutton Selectors

Cam	Contacts	Mounting	Operator Position				Part Number	
			Left		Right			
			Normal	Push	Normal	Push		
A	Operator Only						HW1R-2A-①	
	1NO-1NC	1	HW-U10-F	0	X	0	X	HW1R-2AF11-①
		2	HW-U01-F	X	0	0	0	
	2NO	1	HW-U10-F	0	X	0	X	HW1R-2AF20-①
2		HW-U10-F	0	X	X	X		
2NO-2NC	1	HW-U10-F	0	X	0	X	HW1R-2AF22-①	
	2	HW-U01-F	X	0	0	0		
	3	HW-U10-F	0	X	0	X		
	4	HW-U01-F	X	0	0	0		
D	Operator Only						HW1R-2D-①	
	2NO	1	HW-U10-F	0	X	0	0	HW1R-2DF20-①
		2	HW-U10-F	0	0	0	X	
	2NO-2NC	1	HW-U10-F	0	X	0	0	HW1R-2DF22N1-①
2		HW-U10-F	0	0	0	X		
3		HW-U01-F	X	0	X	X		
4		HW-U01-F	X	X	X	0		
E	Operator Only						HW1R-2E-①	
	2NO-2NC	1	HW-U10-F	0	X	0	0	HW1R-2EF22N1-①
		2	HW-U10-F	0	0	0	X	
		3	HW-U01-F	0	0	X	X	
4		HW-U01-F	X	X	0	0		
F	Operator Only						HW1R-2F-①	
	2NO-2NC	1	HW-U10-F	0	0	0	X	HW1R-2FF22N1-①
		2	HW-U10-F	0	X	0	0	
		3	HW-U01-F	0	0	X	0	
4		HW-U01-F	X	0	0	0		
N	Operator Only						HW1R-2N-①	
	2NO-2NC	1	HW-U01-F	0	0	X	0	HW1R-2NF22N2-①
		2	HW-U10-F	0	X	0	X	
		3	HW-U01-F	0	0	X	0	
4		HW-U10-F	0	X	0	X		
T	Operator Only						HW1R-2T-①	
	2NO-2NC	1	HW-U10-F	0	X	X	Blocked	HW1R-2TF22N1-①
		2	HW-U10-F	0	X	X		
		3	HW-U01-F	X	0	0		
4		HW-U01-F	X	0	0			

① Button Color Code

Color	Code	Color	Code
Black	B	White	W
Green	G	Yellow	Y
Red	R		
Blue	S		

- 1. All assembled part numbers in catalog include Finger-Safe spring-up (HW-U...) contacts.
- 2. Operator only models come with operator and button.

Switches & Pilot Devices

Signaling Lights

Relays & Sockets

Timers

Contactors

Terminal Blocks

Circuit Breakers

Part Number Structure

H W 1 R - 2 D F 22N1 - R

Operator

- A: Cam A
- D: Cam D
- E: Cam E
- F: Cam F
- N: Cam N
- T: Cam T

Contact Arrangement Code

- 11: 1NO-1NC
- 20: 2NO
- (For additional contact codes see previous page)

Button Colors

- B: Black
- G: Green
- R: Red
- S: Blue
- W: White
- Y: Yellow



Note: Use only for interpreting part numbers. Do not use for developing part numbers.

Pushbutton Selectors (Sub-assembled)

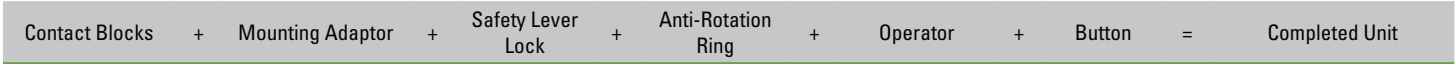

Contact Blocks

Style	Contacts	1NO	1NC
	Finger-Safe	HW-U10-F	HW-U01-F
	Spring-Up Terminal	HW-U10R-F (early make)	HW-U01R-F (late break)
	Dummy Block	HW-DB	

Safety Lever Lock

Style	Part Number
	HW9Z-LS

Buttons

Style	Part Number
Round Flush	HW1A-B1-Ⓢ



In place of Ⓢ, specify the Button Color Code from table below.

Ⓢ Button Color Code

Color	Code	Color	Code
Black	B	White	W
Green	G	Yellow	Y
Red	R		
Blue	S		

Contact Block Mounting Adaptor

(safety lever lock included)

Style	Part Number
	HW-CB2C



- Used to mount contact blocks to operator (first pair only).
- IEEC strongly recommends using the safety lever lock (included) to prevent heavy vibration or maintenance personnel from inadvertently unlocking contacts.

Anti-Rotation Ring

Style	Part Number
	HW9Z-RL



Use with notched panel cutout to prevent unit rotation.

Operators

Style	Description	Part Number
	Cam A	HW1R-2A
	Cam D	HW1R-2D
	Cam E	HW1R-2E
	Cam F	HW1R-2F
	Cam N	HW1R-2N
	Cam T	HW1R-2T

Dual Pushbutton Switches

Key features:

- Two pushbuttons and a pilot light are integrated into one space-saving ø22 mm control unit.
- Momentary and interlock types are available for pushbuttons. Interlock type prevents both buttons from being pressed at the same time.
- Pilot lights are available in full voltage and transformer with LED.
- IP40 protection, IP65 when using silicon boot.



Applications:

- Ideal for use as power switches and start/stop switches (available with I/ON and O/OFF markings on the buttons and a pilot light in the center).
- Interlock type prevents two pushbuttons from being pressed at the same time.

Dual Pushbutton Switches (Assembled) Part Numbers

Without Center Pilot Light

Operation Type	Button Style	Image	Contact Arrangement		Part Number	Ⓔ Button Color Code	Ⓕ Legend Code
			Top Button	Bottom Button			
Momentary	Flush (top) Flush (bottom)		1NO	1NC	HW7D-B11F1001-ⒺⒻ	GR: Green (top) Red (bottom)	Blank: Without legend
			1NO	1NO	HW7D-B11F1010-ⒺⒻ		
			1NO-1NC	1NO-1NC	HW7D-B11F1111-ⒺⒻ		
			2NO	2NC	HW7D-B11F2002-ⒺⒻ		
			2NO	2NO	HW7D-B11F2020-ⒺⒻ		
	Flush (top) Extended (bottom)		1NO	1NC	HW7D-B12F1001-ⒺⒻ		
			1NO	1NO	HW7D-B12F1010-ⒺⒻ		
			1NO-1NC	1NO-1NC	HW7D-B12F1111-ⒺⒻ		
			2NO	2NC	HW7D-B12F2002-ⒺⒻ		
			2NO	2NO	HW7D-B12F2020-ⒺⒻ		
Interlock*	Flush (top) Flush (bottom)		1NO	1NC	HW7D-B21F1001-ⒺⒻ	WB: White (top) Black (bottom)	1: I/ON (top) O/OFF (bottom)
			1NO	1NO	HW7D-B21F1010-ⒺⒻ		
			1NO-1NC	1NO-1NC	HW7D-B21F1111-ⒺⒻ		
			2NO	2NC	HW7D-B21F2002-ⒺⒻ		
			2NO	2NO	HW7D-B21F2020-ⒺⒻ		
	Flush (top) Extended (bottom)		1NO	1NC	HW7D-B22F1001-ⒺⒻ		
			1NO	1NO	HW7D-B22F1010-ⒺⒻ		
			1NO-1NC	1NO-1NC	HW7D-B22F1111-ⒺⒻ		
			2NO	2NC	HW7D-B22F2002-ⒺⒻ		
			2NO	2NO	HW7D-B22F2020-ⒺⒻ		

1. *Interlock type prevents both top and bottom buttons from being pressed simultaneously.
 2. Clear silicon rubber cover part number HW9Z-D7D.
 3. Additional contact configurations available (up to 6 total contacts).

Switches & Pilot Devices

With Center Pilot Light

Operation Type	Button Style	Top Button	Bottom Button	Part Number
Momentary	Flush (Top) Flush (Bottom)	1NO	1NC	HW7D-L11F1001②③-④⑤
		1NO	1NO	HW7D-L11F1010②③-④⑤
		1NO-1NC	1NO-1NC	HW7D-L11F1111②③-④⑤
		2NO	2NC	HW7D-L11F2002②③-④⑤
		2NO	2NO	HW7D-L11F2020②③-④⑤
	Flush (Top) Extended (Bottom)	1NO	1NC	HW7D-L12F1001②③-④⑤
		1NO	1NO	HW7D-L12F1010②③-④⑤
		1NO-1NC	1NO-1NC	HW7D-L12F1111②③-④⑤
		2NO	2NC	HW7D-L12F2002②③-④⑤
		2NO	2NO	HW7D-L12F2020②③-④⑤
Interlock*	Flush (Top) Flush (Bottom)	1NO	1NC	HW7D-L21F1001②③-④⑤
		1NO	1NO	HW7D-L21F1010②③-④⑤
		1NO-1NC	1NO-1NC	HW7D-L21F1111②③-④⑤
		2NO	2NC	HW7D-L21F2002②③-④⑤
		2NO	2NO	HW7D-L21F2020②③-④⑤
	Flush (Top) Extended (Bottom)	1NO	1NC	HW7D-L22F1001②③-④⑤
		1NO	1NO	HW7D-L22F1010②③-④⑤
		1NO-1NC	1NO-1NC	HW7D-L22F1111②③-④⑤
		2NO	2NC	HW7D-L22F2002②③-④⑤
		2NO	2NO	HW7D-L22F2020②③-④⑤

Signaling Lights

Relays & Sockets

Timers

- 1. *Interlock type prevents both top and bottom buttons from being pressed simultaneously.
- 2. Clear silicon rubber cover part number HW9Z-D7D.
- 3. All assembled part numbers in catalog include Finger-Safe spring-up (HW-U...) contacts.

Contactors

Terminal Blocks

Circuit Breakers

② Pilot Light Illumination & Voltage Code

Full Voltage	
Voltage	Code
6V AC/DC, LED	Q2
12V AC/DC, LED	Q3
24V AC/DC, LED	Q4
120V AC, LED	Q8
Step-Down Transformer (6V Secondary LED Voltage)	
Voltage	Code
120V AC, LED	H22
240V AC, LED	M42
480V AC, LED	T82

③ Pilot Lamp Color Code

Color	Code
Amber	A
Green	G
Red	R
Blue	S
White	W

④ Pushbutton Color Code

Color		Code
Top	Green	GR
Bottom	Red	
Top	White	WB
Bottom	Black	

⑤ Engraving Codes

Engraving		Code
No Engraving	Blank	
I/ON	Top	1
O/OFF	Bottom	

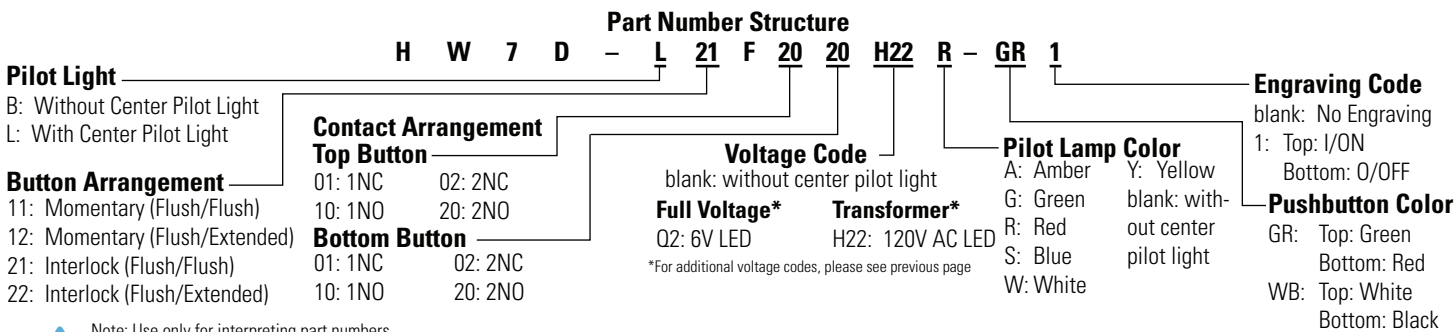

Note: Use only for interpreting part numbers. Do not use for developing part numbers.

Dual Pushbutton Switches (Sub-assembled) Part Numbers

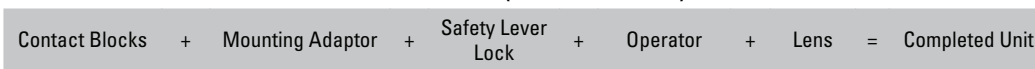

Lamp Circuit Components with Finger-Safe Terminals

Style	Description	Part Number
Lead Holder	For use with HW-CBL on all illuminated pushbutton units. One required for each deck (pair) of contacts.	HW-LH3
Dummy Block with Full Voltage Adaptor	For use with odd number of contacts.	HW-DA1FBN
Full Voltage Adaptor	For use with even number of contacts.	TW-DA1FB
Transformer Unit (6V secondary voltage)	120VAC 240VAC 480VAC	TW-F126B TW-F246B TW-F486B

Contact Blocks

Style	Contacts	1NO	1NC
	Finger-Safe Spring-Up Terminal	HW-U10-F HW-U10R-F (early make)	HW-U01-F HW-U01R-F (late break)
	Dummy Block	HW-DB	

Contact Block Mounting Adaptor

Style	Part Number
Non-illuminated	HW-CB2C
Illuminated (with Pilot Light)	HW-CBL

1. Used to mount contact blocks to operator (first pair only).
 2. IDEC strongly recommends using the safety lever lock (included) to prevent heavy vibration or maintenance personnel from inadvertently unlocking contacts.

Lamps/Lens

Style	Voltage	Part Number
LED	6V AC/DC	LSTD-6Ⓣ
	12V AC/DC	LSTD-1Ⓣ
	24V AC/DC	LSTD-2Ⓣ
	120V AC	LSTD-H2Ⓣ
Non-illuminated	240V AC	LSTD-M4Ⓣ
		HW9Z-B7B
Illuminated		HW9Z-L7W

1. In place of Ⓣ, specify the LED Color Code.
 2. The LED contains a current-limiting resistor and reverse polarity protection diodes.

② LED Color Code

Color	Code	Color	Code
Amber	A	Blue	S
Green	G	White	W
Red	R		

Operators

Style	Button	Part Number
	Flush (top)	HW7D-*11Ⓣ-Ⓣ
	Flush (bottom)	
	Flush (top)	HW7D-*12Ⓣ-Ⓣ
	Extended (bottom)	
	Flush (top)	HW7D-*21Ⓣ-Ⓣ
	Flush (bottom)	
	Flush (top)	HW7D-*22Ⓣ-Ⓣ
	Extended (bottom)	

Instead of * insert:
 B: Non-illuminated
 L: Illuminated

Safety Lever Lock

Style	Part Number
	HW9Z-LS

Anti-Rotation Ring

Appearance	Part Number
	HW9Z-RL

Use with notched panel cutout to prevent unit rotation.

⑤ Engraving Codes

Engraving	Code
No Engraving	Blank
I/ON	Top
O/OFF	Bottom

④ Pushbutton Color Code

Color	Code	Color	Code
Top	Green	Top	White
Bottom	Red	Bottom	Black
	GR		WB

Contact Arrangement Chart

Contact Arrangement			Contact Block		Top Button		Bottom Button		
Top Button	Bottom Button	Contact Code	Mounting Position	Type	Normal	Push	Normal	Push	
1NO	1NO	1010	1	NO		X			
			2	NO				X	
1NO	1NC	1001	1	NO		X			
			2	NC			X		
1NC	1NO	0110	1	NC	X				
			2	NO				X	
1NC	1NC	0101	1	NC	X				
			2	NC			X		
1NO	2NO	1020	1	NO		X			
			2	NO				X	
			3	Dummy					
			4	NO					X
1NO	1NO-1NC	1011	1	NO		X			
			2	NO				X	
			3	Dummy					
			4	NC				X	
1NO	2NC	1002	1	NO		X			
			2	NC			X		
			3	Dummy					
			4	NC				X	
1NC	2NO	0120	1	NC	X				
			2	NO				X	
			3	Dummy					
			4	NO					X
1NC	1NO-1NC	0111	1	NC	X				
			2	NO				X	
			3	Dummy					
			4	NC				X	
1NC	2NC	0102	1	NC	X				
			2	NC				X	
			3	Dummy					
			4	NC				X	
2NO	1NO	2010	1	NO		X			
			2	NO					X
			3	NO		X			
			4	Dummy					
2NO	1NC	2001	1	NO		X			
			2	NC			X		
			3	NO		X			
			4	Dummy					
1NO-1NC	1NO	1110	1	NO		X			
			2	NO					X
			3	NC	X				
			4	Dummy					
1NO-1NC	1NC	1101	1	NO		X			
			2	NC			X		
			3	NC	X				
			4	Dummy					

Contact Block Mounting Position Example

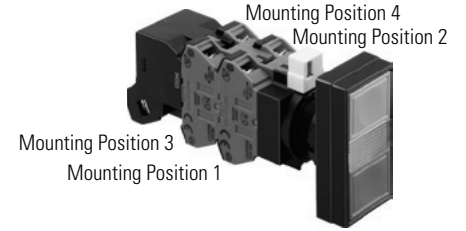

1. Transformers can have two or four contact blocks only.
 2. Contact blocks 1 and 3 are actuated by the top button. Contact blocks 2 and 4 are actuated by the bottom button.

Contact Arrangement Chart (con't)

Contact Arrangement			Contact Block		Top Button		Bottom Button		
Top Button	Bottom Button	Contact Code	Mounting Position	Type	Normal	Push	Normal	Push	
2NC	1NO	0210	1	NC	X				
			2	NO				X	
			3	NC	X				
			4	Dummy					
2NC	1NC	0201	1	NC	X				
			2	NC			X		
			3	NC	X				
			4	Dummy					
2NO	2NO	2020	1	NO		X			
			2	NO				X	
			3	NO		X			
			4	NO					X
2NO	1NO-1NC	2011	1	NO		X			
			2	NO				X	
			3	NO		X			
			4	NC				X	
2NO	2NC	2002	1	NO		X			
			2	NC				X	
			3	NO		X			
			4	NC				X	
1NO-1NC	2NO	1120	1	NO		X			
			2	NO				X	
			3	NC	X				
			4	NO					X
1NO-1NC	1NO-1NC	1111	1	NO		X			
			2	NO				X	
			3	NC	X				
			4	NC				X	
1NO-1NC	2NC	1102	1	NO		X			
			2	NC				X	
			3	NC	X				
			4	NC				X	
2NC	2NO	0220	1	NC	X				
			2	NO				X	
			3	NC	X				
			4	NO					X
2NC	1NO-1NC	0211	1	NC	X				
			2	NO				X	
			3	NC	X				
			4	NC				X	
2NC	2NC	0202	1	NC	X				
			2	NC				X	
			3	NC	X				
			4	NC				X	

Contact Block Mounting Position Example

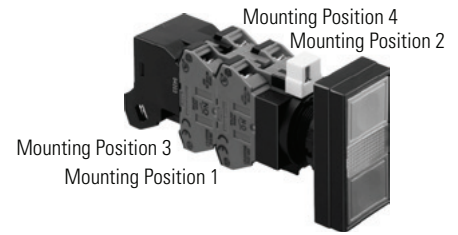

Contactor Reset Button



Reset Buttons (Assembled)

	Plastic Bezel	Metal Bezel
(Blank)	HW1B-M1RS-⓪T	HW4B-M1RS-⓪T
Engraved "R"	HW1B-M1RS-⓪T-ENG-R	HW4B-M1RS-⓪T-ENG-R

- 1. In place of ⓪ specify Button Color Code.
- 2. 130mm (5.1") overall length.
- 3. 16mm flat base for easy alignment

⓪ Button Color Code

Color	Code	Color	Code
Black	B	White	W
Green	G	Yellow	Y
Red	R		
Blue	S		

Contactor Reset Button (Sub-assembled)



Rod

Style	Part Number
	HW9Z-RS-TK2141

Operator

Style	Plastic	Metal
	HW1B-M0	HW4B-M0
		

Button

Style	Part Number
	HW1A-B1-⓪

- ⓪ In place of ⓪, specify the Button Color Code from table.

⓪ Button Color Code

Color	Code	Color	Code
Black	B	White	W
Green	G	Yellow	Y
Red	R		
Blue	S		

Nameplates - HW Series

	HWAM-Black Plastic	HWAQ-Black Plastic	HWAS-Black Plastic	HWAV-Yellow Plastic
Nameplate (blank engraving plate included)	HWAM-OB	HWAQ-OB	HWAS-OB	HWAV-0-Y HWAV5-0†
Nameplate (engraved)	HWAM-⓪	HWAQ-⓪	HWAS-⓪	HWAV-27-Y* HWAV5-27†
Additional Insert (blank)	HWNP-0	HWNP-0	HWNP Dimensions 	
Additional Insert (engraved)	HWNP-⓪	HWNP-⓪		

- 1. In place of ⓪, insert either the standard legend code from table below or custom engraving delimited by " ".
- 2. Standard engravings are available at no charge.
- 3. * HWAV-27-Y comes engraved "Emergency Stop" as shown in drawing.
- 4. † HWAV5-27 and HWAV5-0 for 60mm diameter E-Stops (80mm diameter nameplate).

Standard Legend Codes

Pushbuttons				Pushbuttons/Selector Switches				Selector Switches	
Legend	Code	Legend	Code	Legend	Code	Legend	Code	Legend	Code
AUTO	101	OPEN	116	AUTO-MAN	201	REV-FOR	216	AUTO-MAN-OFF	301
CLOSE	102	OUT	117	CLOSE-OPEN	202	RUN-JOG	217	AUTO-OFF-MAN	302
DOWN	103	RAISE	118	DOWN-UP	203	RUN-SAFE	218	CLOSE-OFF-OPEN	303
EMERG.STOP	104	RESET	119	FAST-SLOW	204	SAFE-RUN	219	DOWN-OFF-SLOW	304
FAST	105	REVERSE	120	FOR-REV	205	SLOW-FAST	220	FAST-OFF-SLOW	305
FORWARD	106	RUN	121	HAND-AUTO	206	START-STOP	221	FOR-OFF-REV	306
HAND	107	SLOW	122	HIGH-LOW	207	STOP-START	222	LEFT-OFF-RIGHT	307
HIGH	108	START	123	JOG-RUN	208	UP-DOWN	223	LOWER-OFF-RAISE	308
IN	109	STOP	125	LEFT-RIGHT	209	OI (Int'l OFF ON)	250	OFF-MAN-AUTO	309
INCH	110	TEST	126	LOWER-RAISE	210			OFF-SLOW-FAST	310
JOG	111	UP	127	MAN-AUTO	211			OFF-1-2	311
LOW	112	I (Int'l On)	150	OFF-ON	212			OPEN-OFF-CLOSE	312
LOWER	113	O (Int'l Off)	151	ON-OFF	213			SLOW-OFF-FAST	313
OFF	114	EMO	152	OPEN-CLOSE	214			SUMMER-OFF-WINTER	314
ON	115			RAISE-LOWER	215			UP-OFF-DOWN	315
								1-OFF-2	316
								HAND-OFF-AUTO	317

- 1. To order engraved nameplates, add legend code to nameplate part number.
- 2. Character height based on the number of characters and size of nameplate. Standard character size is 3/16".
- 3. Nameplates with standard legends are the same list price as blank nameplates.
- 4. Nameplates have built-in anti-rotation feature for use with notched panel cut-outs. Additional anti-rotation ring (HW9Z-RL) is not necessary.

Switches & Pilot Devices

Signaling Lights

Relays & Sockets

Timers

Contactors

Terminal Blocks

Circuit Breakers

Nameplates Order Form — HW Series

Copy this order form and use it to specify Letter Height, Custom Engravings, Location of Engraving on Nameplate, and Quantity Desired.

To ensure engraving accuracy, fax it to your IDEC representative or Distributor.

Your Company: _____
 Name: _____
 Telephone: _____
 Fax & Email: _____

IDEC Rep/Distributor Contact: _____
 PO number (if known): _____
 IDEC Rep/Distributor Phone: _____
 IDEC Rep/Distributor Fax & Email: _____

HWAM Nameplate

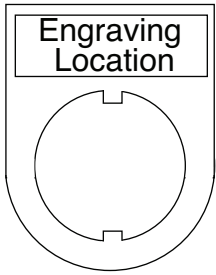

Step 1. Choose Letter Size - 7/64" or 1/8".
 Check the box for the letter size you want. Then write your lettering in box below the check boxes. Note: 1/8" size letters cannot exceed 9 characters.

7/64" Letter Size 11 characters maximum (for 7/64" size letters)

1/8" Letter Size 9 characters maximum (for 7/8" size letters)

Step 2. Specify Quantity.
 Enter the number of nameplates desired in the box on the right.

Qty

1 2 3 4 5 6 7 8 9 10 11

Sample Letter Sizes
 7/64" Letters: A B C D
 1/8" Letters: A B C D

HWAQ Nameplate

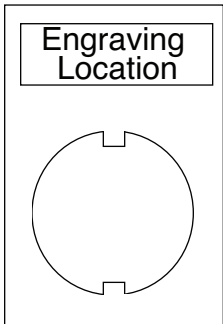

Step 1. Choose Letter Size - 7/64" or 1/8".
 Check the box for the letter size you want. Then write your lettering in box below the check boxes. Note: 1/8" size letters cannot exceed 9 characters.

7/64" Letter Size 11 characters maximum (for 7/64" size letters)

1/8" Letter Size 9 characters maximum (for 1/8" size letters)

Step 2. Specify Quantity.
 Enter the number of nameplates desired in the box on the right.

Qty

1 2 3 4 5 6 7 8 9 10 11

Sample Letter Sizes
 7/64" Letters: A B C D
 1/8" Letters: A B C D

HWAS Nameplate

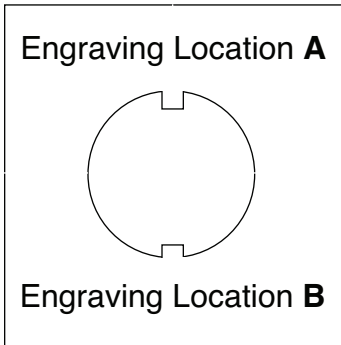

Step 1. Choose Letter Size - 3/32" or 1/8".
 Check the box for the letter size you want. Then write your lettering in box below the check boxes. Note: 1/8" size letters cannot exceed 14 characters.

3/32" Letter Size 20 characters maximum (for 3/32" size letters)

1/8" Letter Size 14 characters maximum (for 1/8" size letters)

Step 2. Specify Quantity.
 Enter the number of nameplates desired in the box on the right.

Qty

Step 3. Specify Location.
 Enter the location of engraving (A or B or Both), in box on the right.

Location

A 1 2 3 4 5 6 7 8 9 10 11 12 13 14 15 16 17 18 19 20

B 1 2 3 4 5 6 7 8 9 10 11 12 13 14 15 16 17 18 19 20

Sample Letter Sizes
 3/32" Letters: A B C D
 1/8" Letters: A B C D

Switch Engraving Order Form – HW Series

Copy this order form and use it to specify Letter Height, Maximum Number of Lines and Text to be engraved.

To ensure engraving accuracy, fax it to your IDEC representative or Distributor.

Your Company: _____
 Name: _____
 Address: _____
 PO: _____

Telephone: _____
 Fax: _____
 Email: _____
 Part Number to be Engraved: _____

Please check one of the boxes below to indicate your choice of engraving options:



ø29mm, ø40mm Mushroom Head

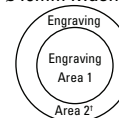

	# of Lines	Letter Height	Max. Characters Per Line
<input type="checkbox"/>	1	5/32	5
<input type="checkbox"/>		1/8	6
<input type="checkbox"/>	2	5/32	5
<input type="checkbox"/>		1/8	6
<input type="checkbox"/>	3	1/8	6
<input type="checkbox"/>	4	3/32	5

	# of Lines	Letter Height	Max. Characters Per Line
<input type="checkbox"/>	1	5/32	5
<input type="checkbox"/>		1/8	5
<input type="checkbox"/>	2	5/32	5
<input type="checkbox"/>		1/8	6
<input type="checkbox"/>	3	1/8	5
<input type="checkbox"/>	4	3/32	5

		# of Lines	Letter Height	Max. Characters Per Line
<input type="checkbox"/>	Engraving Area 1	1	5/32	5
<input type="checkbox"/>			1/8	5
<input type="checkbox"/>	Engraving Area 2	1	5/32	7
<input type="checkbox"/>			1/8	7



- Above mentioned specifications hold true for standard size pushbuttons (round and square).
- *Engraving Area 2 can be engraved for 40mm mushroom Head non-illuminated push button only.
- Engraving is done on the button itself for non-illuminated push buttons and on marking plate for illuminated push buttons and pilot lights.
- Please enter text exactly how you want it engraved, take care to emphasize capital or small letters.

Enter text to be engraved:

Sample Letter Sizes

1/8 Letters: **OPEN**

5/32 Letters: **OPEN**

Line 1: _____
 Line 2: _____
 Line 3: _____
 Line 4: _____

For IDEC Internal Use Only:

Work Order #: _____

Switches & Pilot Devices

Signaling Lights

Relays & Sockets

Timers

Contactors

Terminal Blocks



Circuit Breakers



Accessories

Item	Appearance	Description/Usage	Part Number	
Locking Ring Wrench		Metallic tool used to tighten the plastic locking ring when installing the HW series in a panel	MW9Z-T1	
Lamp/LED Removal Tool		Rubber tool makes lamp/LED removal easier.	OR-55	
Anti-Rotation Ring		Prevents rotation of switches in panel. (included with all assembled switches except pilot lights)	for notched panel cutout (standard)	HW9Z-RL
			for round panel cutout	LW9Z-L
Rubber Mounting Hole Plug		Black rubber plug fills unused 7/8" mounting holes in panel.	OB-31	
Metallic Mounting Hole Plug		For plugging unused 7/8" mounting holes in the panel. Tighten the attached locking ring to a torque of 12 kfg-cm maximum Degree of protection: IP66	LW9Z-BM	
Pushbutton Clear Boot		Used to cover and protect pushbuttons Operating temperature: -50 to +60°C	Flush Pushbuttons	OC-31
			Extended Pushbuttons	OC-32
Padlock Cover		Plastic hinged padlockable cover to protect pushbuttons or selector switches. (Not intended for E-Stops) Degree of protection: IP65	HW9Z-KL1	
Tab Terminal Adapter		Tab #250 (6.35 x 0.8mm): Single tab	TW-FA4	
Mounting Adaptor		Used to mount round HW series (except Jumbo Mushroom, unibody, and square units) into a larger panel cut-out. (includes both pieces)	22 to 30mm	HW9Z-A30
			22 to 25mm	HW9Z-A25
Replacement Safety Lever Lock		Used to prevent contact mounting lever from moving due to heavy vibration or panel maintenance.	HW9Z-LS	
Reset Rod for Contactors Overload		5" rod used with HW1B-M0.	HW9Z-RS-TK2141	
Replacement Operator Washer		Provided with operator. Insert between bezel and locking ring.	HWM-WASHER	
Replacement Locking Ring		Plastic locking nut comes with all HW operators & assemblies.	Standard (plastic)	HW9Z-LN
			Optional (metal)	HW9Z-LNM
Switch Cover (Square)		Used only with round or square flush pushbuttons.	HW9Z-K1 (spring return) HW9Z-K11 (maintained cover)	
Replacement Keys		Pair of Keys (#231)	HW9Z-SKP	
Replacement Lens		HW Illuminated Unibody Replacement Lens	HWLVL-LENSR	

Item	Appearance	Description/Usage	Part Number	
Replacement Jumbo Dome Lens		Polycarbonate Replacement Lens (If using yellow lens, use white LED.)	HW1A-P5Ⓞ Ⓞ = (A, G, R, S, W, Y))	
Replacement Jumbo LED Diffusing Lens			HW9Z-PP5C	
Replacement LED Lamps for HW Jumbo Dome		Replacement LED Lamp - applicable for jumbo pilot lights only	LSTDB-2Ⓞ Ⓞ = (A, G, R, S, W)	
Rubber Cover for Dual Pushbuttons		Clear Silicon rubber cover	HW9Z-D7D	
Barrier for Dual Pushbuttons		Plastic barrier. Used when mounting the HW7 units on 30mm horizontal centers, to prevent possible interconnections between adjoining terminals.	HW-VU1	
EMO Sticker		Emergency stop nameplate sticker	HW9Z-EMO-NP-TK2120	
Contact Blocks (with side entry)		These contacts are applicable for wires terminated by ring, fork, terminals, not recommended for bare wire connections.	1NC	1NO
			HW-U01 HW-U01-MAU HW-U01R HW-U01R-MAU (with side entry)	HW-U10 HW-U10-MAU HW-U10R HW-U10R-MAU (with side entry)
Contact Blocks (without side entry)		These contacts are applicable for wires terminated by ring, fork, or ferule terminals, and also bare wire connections.	HW-U01-F HW-U01-MAU-F HW-U01R-F HW-U01R-MAU-F (no side entry)	HW-U10-F HW-U10-MAU-F HW-U10R-F HW-U10R-MAU-F (no side entry)

E-Stop Shruds

Style	Part Numbers	E-Stop Types	Applicable Standards
	HW9Z-KG1	40mm Mushroom Head	SEMI S2-0703, 12.5.1 Compliant
	HW9Z-KG2	40mm Mushroom Head	SEMI S2-0703, 12.5.1 & SEMATECH Compliant

Style	Part Numbers	E-Stop Types	Applicable Standards
	HW9Z-KG3	40mm Mushroom Head	SEMI S2 Compliant (Approved by TUV) ISO 13850
	HW9Z-KG4	40mm Mushroom Head	SEMI S2 Compliant (Approved by TUV) & SEMATECH ISO 13850

Switches & Pilot Devices

Signaling Lights

Relays & Sockets

Timers

Contactors

Terminal Blocks

Circuit Breakers

Contact Assemblies

Standard Contact Assemblies

For use with Non-Illuminated Pushbuttons & E-Stops

Style	Contacts	Part Number
	1NO	HW-CBF10
	1NC	HW-CBF01
	1NO/1NC	HW-CBF11
	2NO	HW-CBF20
	2NC	HW-CBF02
	2NO/2NC	HW-CBF22



Gold contact option is available. Add suffix "MAU" to end of part number. For example, HW-CBF20 becomes HW-CBF20-MAU.

Full Voltage Contact Assemblies

For use with Illuminated Pushbuttons.

Style	Contacts	Part Number
	1NO	HW-FL10Q0
	2NO	HW-FL20Q0
	1NO/1NC	HW-FL11Q0
	1NC	HW-FL01Q0
	2NC	HW-FL02Q0



Order LED separately.

Transformer Contact Assemblies

For use with Illuminated Pushbuttons.

Style	Contacts	Part Number
	120V AC with LED	1NO HW-FL10H2-Ⓢ 2NO HW-FL20H2-Ⓢ 1NC HW-FL01H2-Ⓢ 1NO/1NC HW-FL11H2-Ⓢ
	240V AC with LED	1NO HW-FL10M4-Ⓢ 2NO HW-FL20M4-Ⓢ 1NC HW-FL01M4-Ⓢ 1NO/1NC HW-FL11M4-Ⓢ
	480V AC with LED	1NO HW-FL10T8-Ⓢ
		2NO HW-FL20T8-Ⓢ 1NC HW-FL01T8-Ⓢ 1NO/1NC HW-FL11T8-Ⓢ



- In place of Ⓢ, specify the LED Color Code.
Ⓢ = A, G, R, S, or W
- 6V LED included.

Dimensions (mm)

Non-Illuminated Pushbuttons

Flush (HW1B-M1, -A1)

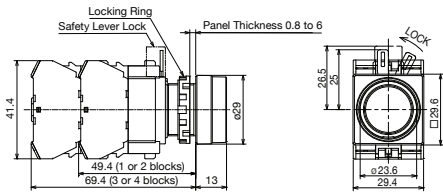

Extended (HW1B-M2, -A2)

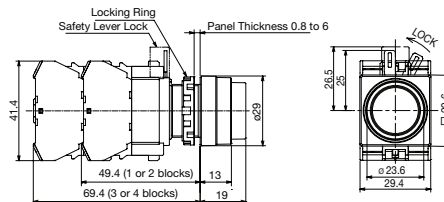

ø29mm Mushroom (HW1B-M3 -A3)

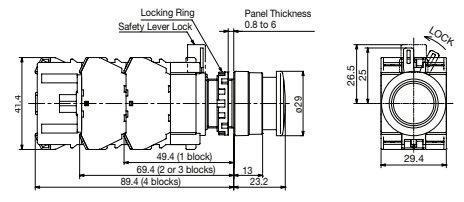

ø40mm Mushroom (HW1B-M4, -A4)

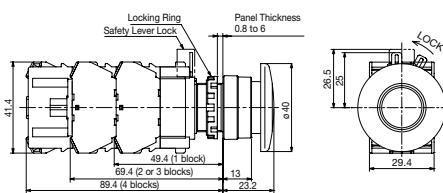

ø60mm Mushroom (HW1B-M5)

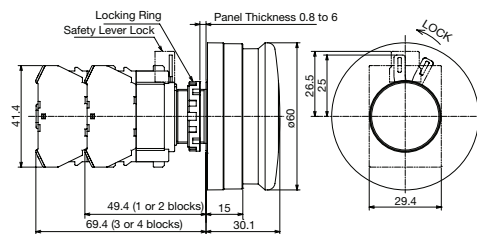

Square Flush (HW2B-M1, -A1)

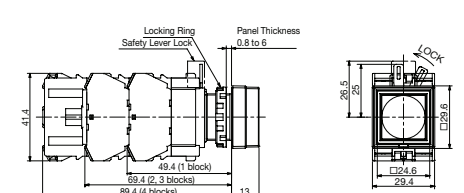

Square Extended (HW2B-M2, -A2)

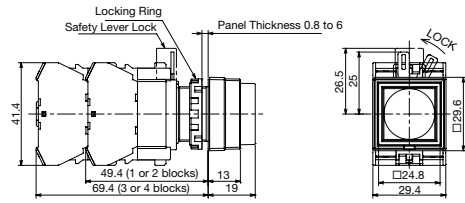

Contact Block (Bottom View)

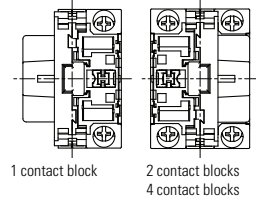

Terminal Wiring

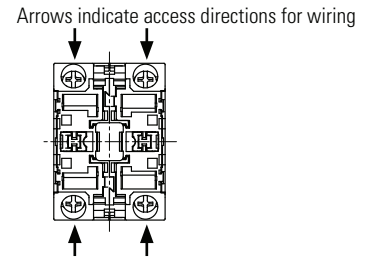

Operators

Flush (Round & Square)

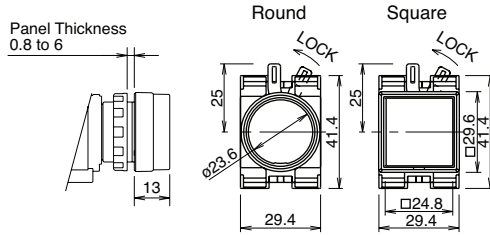

Extended

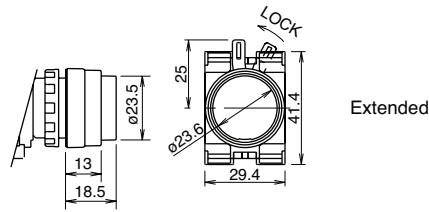

Extended with Full Shroud

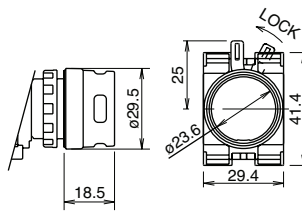

ø40mm Mushroom

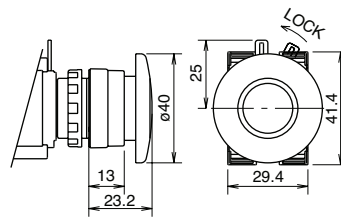

Emergency Stop Pushbuttons

ø29mm Head Pushlock Turn Reset (HW1B-V3)

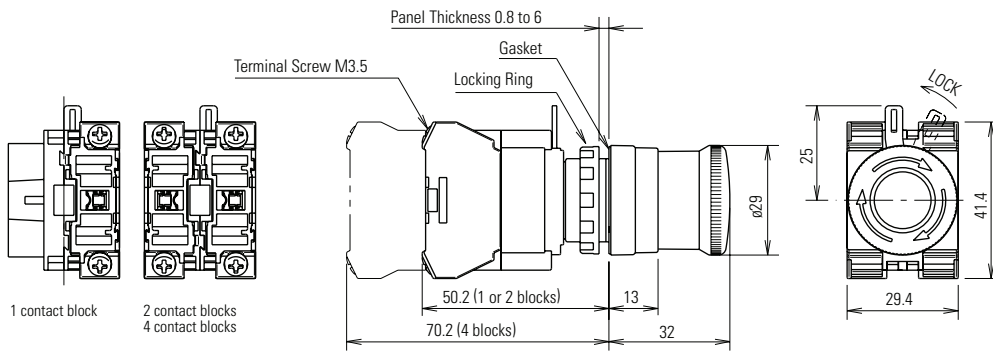

ø40mm Head Pushlock Turn Reset (HW1B-V4)

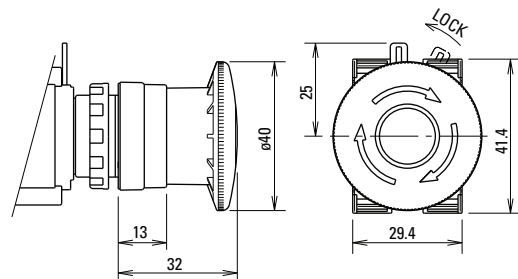

ø40mm Head EMO Pushlock Turn Reset (HW1B-V4)

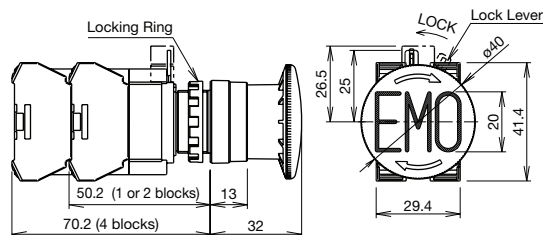

Dimensions (mm)

Dimensions (mm)

ø40mm Head Pushlock Key Reset (HW1B-X4)

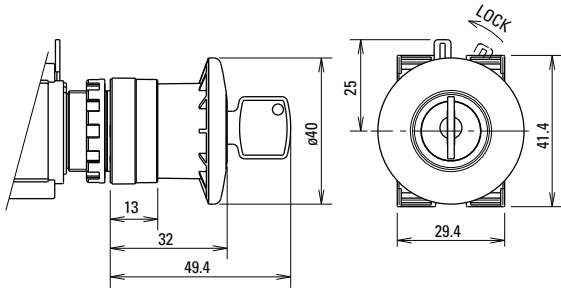

ø60mm Head Pushlock Turn Reset (HW1B-V5)

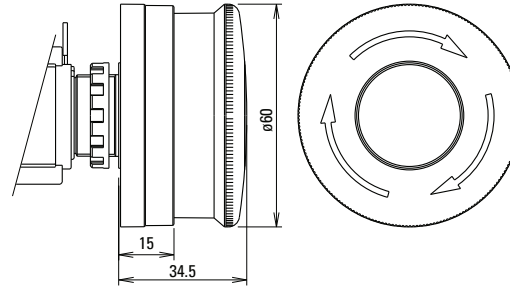

ø40mm Head Push-Pull (HW1B-Y2)

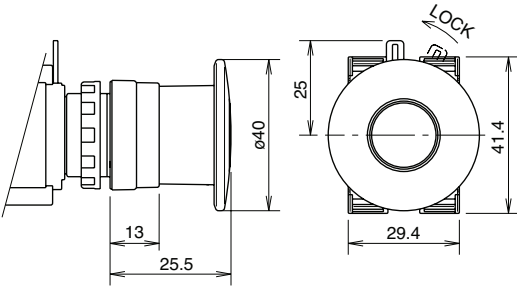

ø40mm Head Unibody Pushlock Turn Reset (HW1B-BV4)

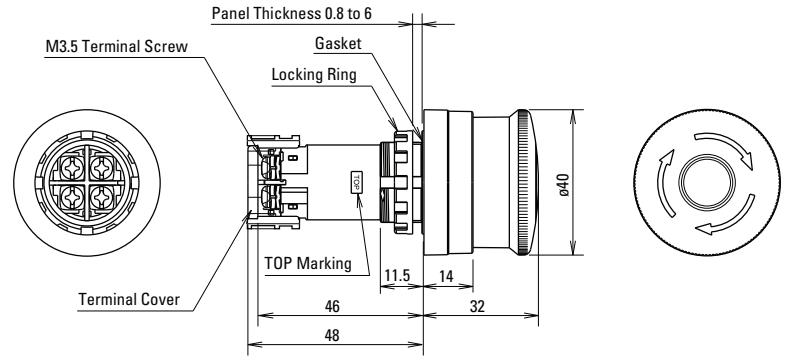

Illuminated E-Stop Pushbuttons (HW1E-LV4)

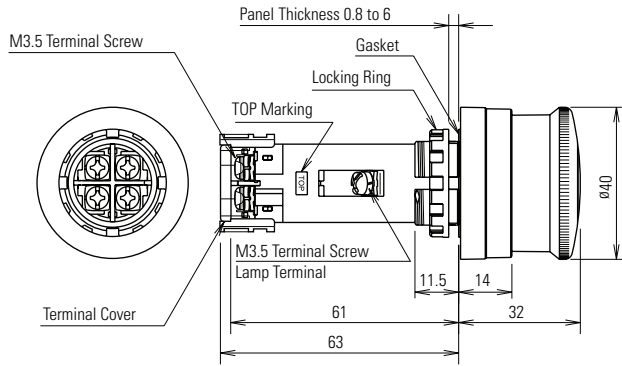

Mounting Hole

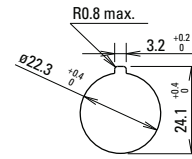

The minimum mounting centers shown below are applicable to E-Stop switches with one layer of contact blocks (two contact blocks). When two layers of contact blocks are mounted, determine the minimum mounting centers for ease of wiring.

Unit	Vertical Spacing	Horizontal Spacing
HW1B-V3	50 mm	50 mm
HW1B-V4		
HW1B-X4		
HW1B-Y2		
HW1B-V5	60 mm	60 mm

Terminal Arrangement (Bottom View)

HW1E-BV4

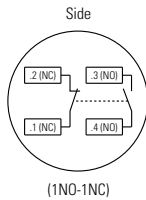

HW1E-LV4

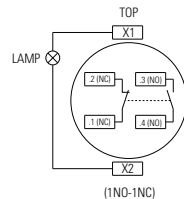

Emergency Stop Stations

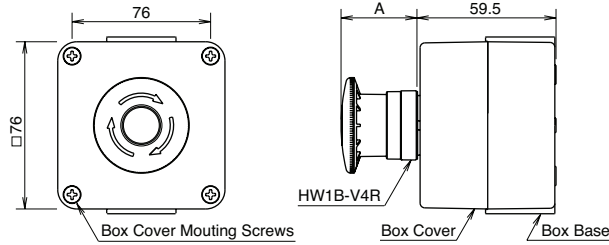

Operator	Dimension A (mm)
Pushlock Turn Reset	32
Pushlock Key Reset	32 (Key inserted: 49.4)
Push Pull	25.5

Mounting Hole Layout

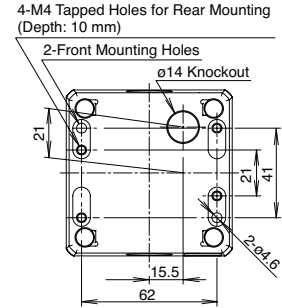

Dimensions (mm)

Pilot Lights

Round Flush Terminal screws: M3.5, integrated terminal cover

6, 12, 24V AC/DC, Without LED lamp

100/110V AC, 200/220V AC (240V AC maximum)

110V DC, 380V AC minimum

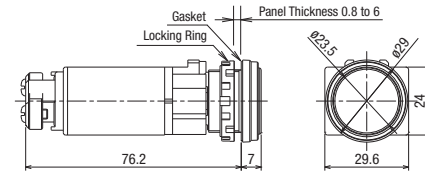
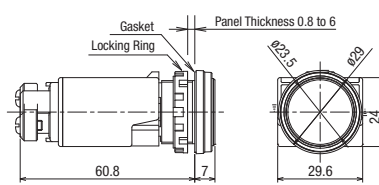
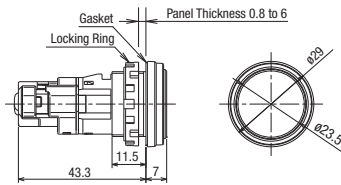

Dimensions (mm)

Extended Terminal screws: M3.5, integrated terminal cover

6, 12, 24V AC/DC, Without LED lamp

100/110V AC, 200/220V AC (240V AC maximum)

110V DC, 380V AC minimum

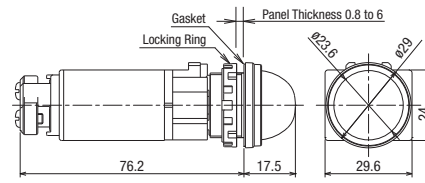
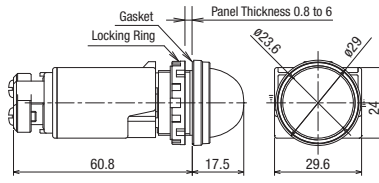
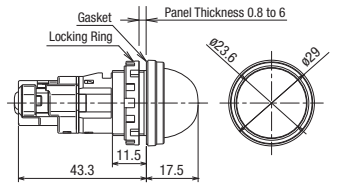

Square Flush Terminal screws: M3.5, integrated terminal cover

6, 12, 24V AC/DC, Without LED lamp

100/110V AC, 200/220V AC (240V AC maximum)

110V DC, 380V AC minimum

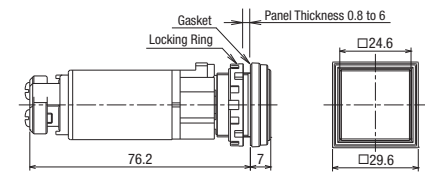
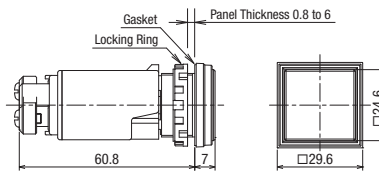
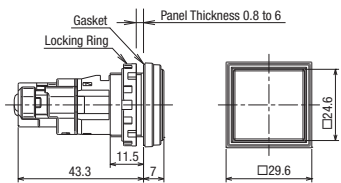

Jumbo Dome Pilot Light Terminal cover

Panel Thickness 1 to 5

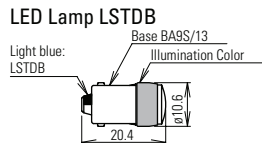
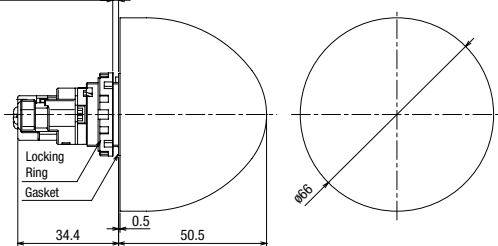

Mounting Hole Layout

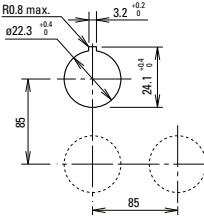

Mounting Hole Layout

Close mounting on 30mm centers
Degree of protection: IP65

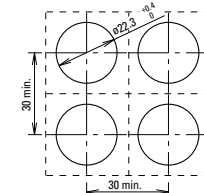

When mounting transformer or DC-DC converter type units on 30mm centers vertically and horizontally, keep the ambient temperature below 40°C.

Switches & Pilot Devices

Signaling Lights

Relays & Sockets

Timers

Contactors

Terminal Blocks

Circuit Breakers

Illuminated Pushbuttons

Full Voltage Models

1 Contact Block

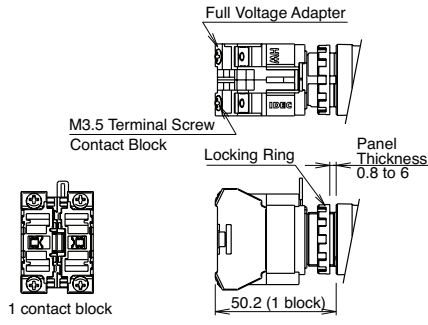

2 Contact Blocks

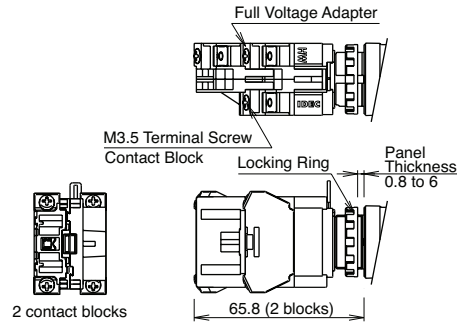

3 Contact Blocks

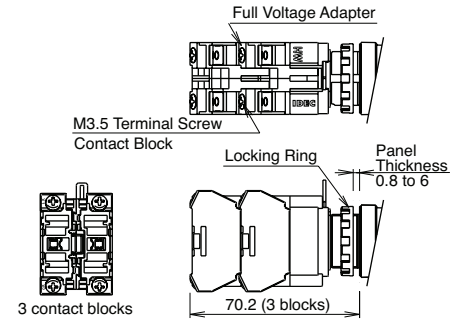

Illuminated Pushbuttons con't

4 Contact Blocks

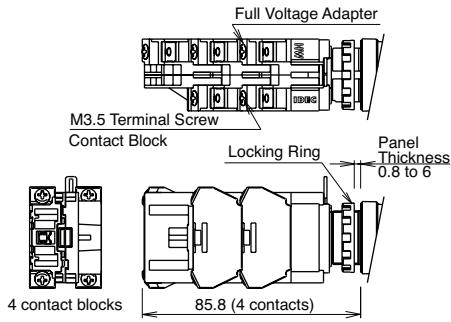

Dimensions (mm)

Terminal Wiring

Arrows indicate access directions for wiring.

Contact Block

Full Voltage Adaptor

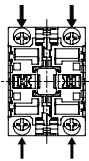

Transformer

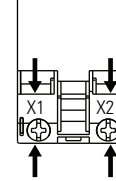

Transformer Models

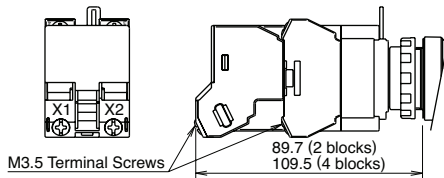

DC-DC Converter Models

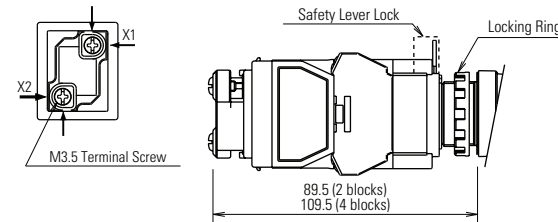

Non-Illuminated Selector & Key Switches

Knob Operator

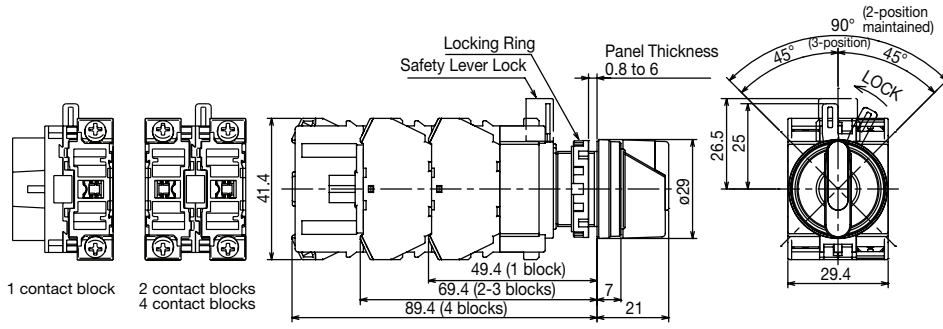

1 contact block
2 contact blocks
4 contact blocks

Dimensions (mm)

Terminal Wiring

Arrows indicate access directions for wiring.

Contact Block Full Voltage Adaptor

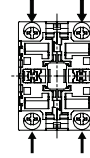

Key Operator

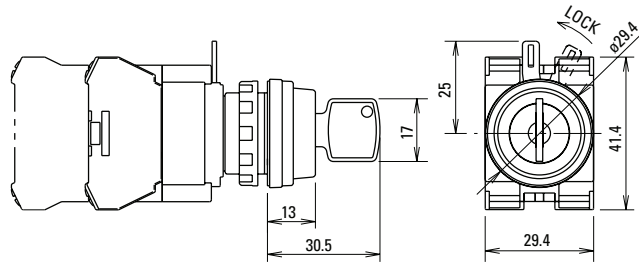

Transformer

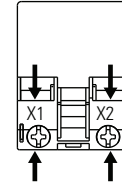

Illuminated Selector Switches

Full Voltage Model

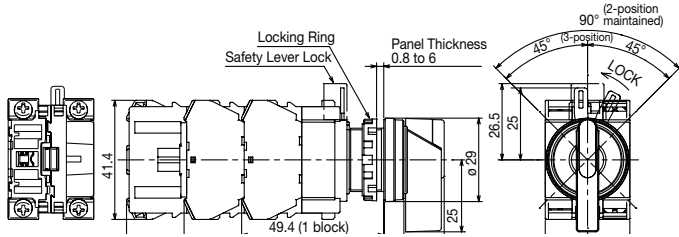

Transformer Model

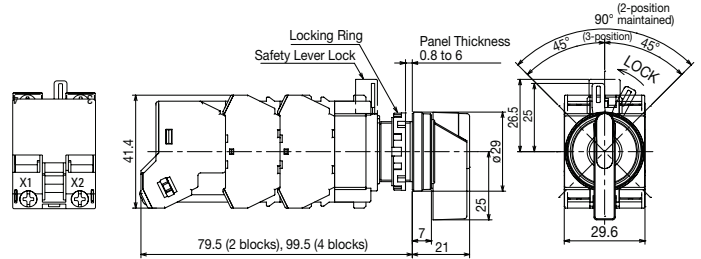

Switches & Pilot Devices

Signaling Lights

Relays & Sockets

Timers

Contractors

Terminal Blocks

Circuit Breakers

Dual Pushbutton

Without Pilot Light

Dimensions (mm)

Mounting Hole Layout

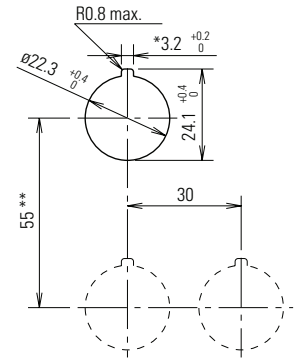

-The 3.2 mm recess is for preventing rotation and is not necessary when a nameplate or anti-rotation ring is not used.
 -When using the safety lever lock, determine the vertical spacing in consideration of convenience for installing and removing the safety lever lock.
 -Recommended vertical spacing: 100 mm
 -The minimum mounting centers are applicable to switches with one layer of contact blocks (two contact blocks). When two layers of contact blocks are mounted, determine the minimum mounting centers for ease of wiring.

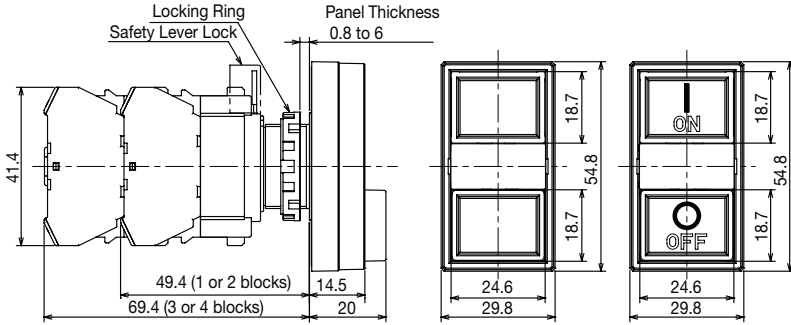
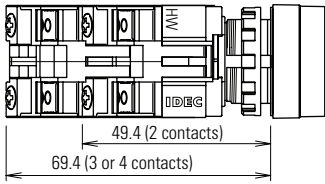

With Pilot Light

Full Voltage

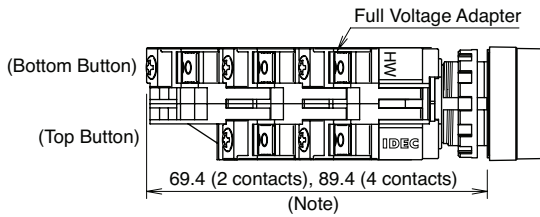

The depth of a 3-contact model depends on the combination of contact blocks at top and bottom pushbuttons.

Top Button	1 contact block	2 contact blocks
Bottom Button	2 contact blocks	1 contact block
Depth	89.4 mm	69.4 mm

Transformer (240V minimum)

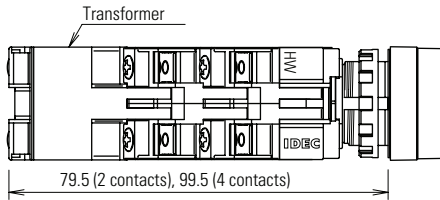

Transformer (480V)

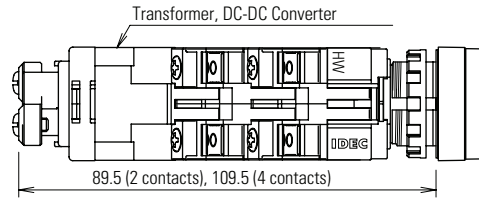

Monolever

Dimensions

Standard Lever

Interlocking Lever

All dimensions in mm.

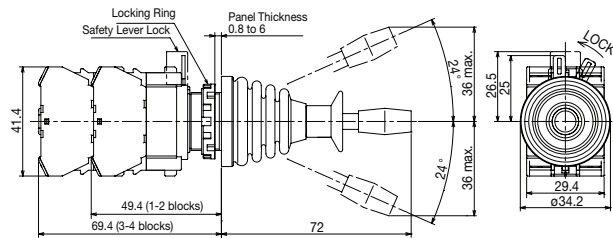
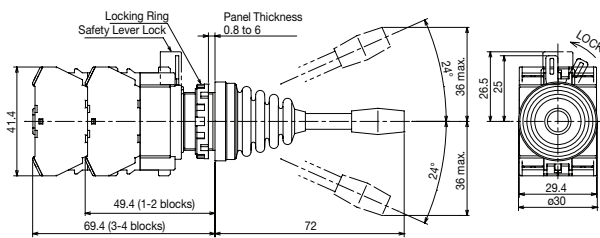

Terminal Screws M3.5 Integrated Terminal Cover

Accessory Dimensions

LW9Z-BM
Metallic Mounting Hole Plug

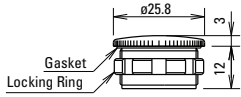

OB-31
Rubber Mounting Hole Plug

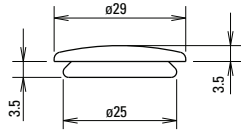

HW9Z-RL
Anti-Rotation Ring

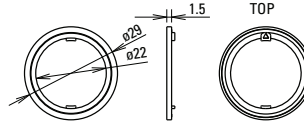

OR-55
Lamp/LED Removal Tool

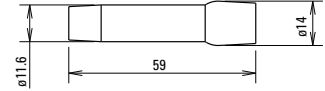

HW9Z-D7D
Dual Pushbutton Rubber Cover

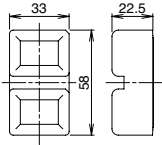

HW-VU1
Dual Pushbutton Barrier

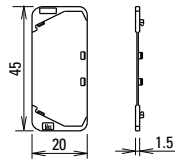

MW9Z-T1
Locking Ring Wrench

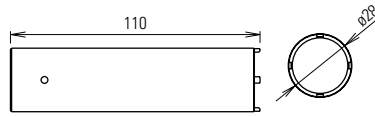

HW-VL1
Barrier

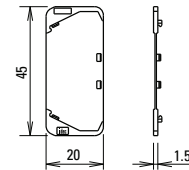

HW9Z-KL1
Padlock Cover

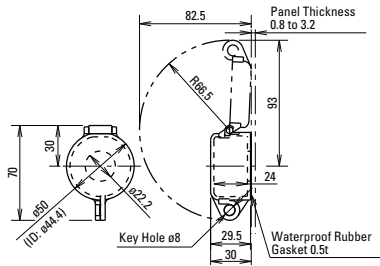

HWLS-TK1971
Safety Lever Lock

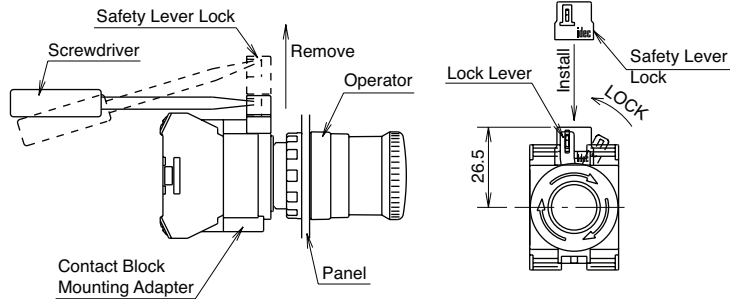

HW9Z-KG1

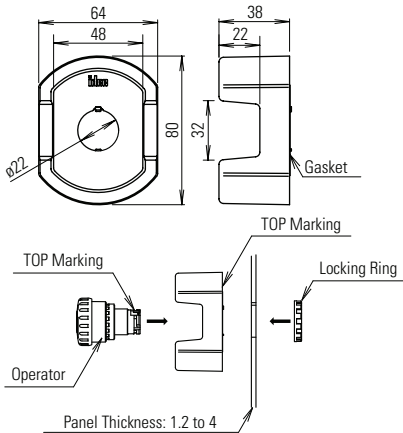

HW9Z-KG2

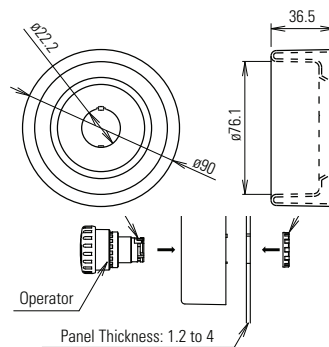

HW9Z-KG3

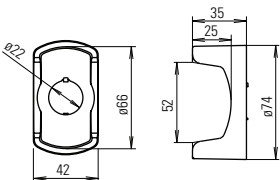

HW9Z-KG4

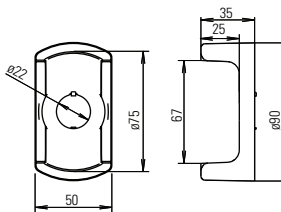

LSTD

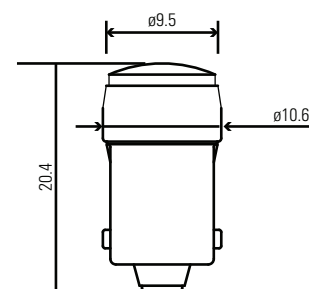

Specification Charts

INDUCTIVE

DC Voltages

Voltage V	24	48	110
Current A	4	2	1.1

AC Voltages

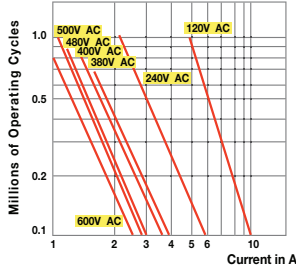

RESISTIVE

DC Voltages

Voltage V	24	48	110
Current A	8	4	2.2

AC Voltages

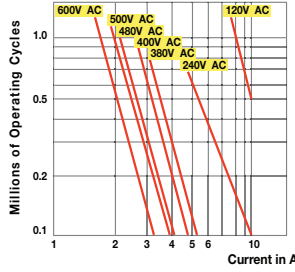

Conforming to IEC 947-5-1 Appendix C.
Utilization categories AC-15 and DC-13.
Operation rate: 1,800 op. hour
Load factor:
Inductive 0.4 ± 0.05
Resistive 0.9 ± 0.05

2 Position Selector Switches

	Contact	Mounting Position	Operator Position	
			Left	Right
HW1S-2T HW1K-2* HW1F-2	HW-U10-F (NO)	L	0	X
		R	0	X
	HW-U01-F (NC)	L	X	0
		R	X	0
	HW-U10R-F (NO-EM)	L	0	X
		R	0	X
HW-U01R-F (NC-LB)	L	X	0	
	R	X	0	

Operator Truth Tables

3 Position Selector Switches con't

	Contact	Mounting Position	Operator Position		
			Left	Center	Right
HW1S-3JT HW1K-3J*	HW-U10-F (NO)	L	X	0	0
		R	0	0	X
	HW-U01-F (NC)	L	0	X	0
		R	0	X	0
	HW-U10R-F (NO-EM)	L	X	0	X
		R	X	0	X
HW-U01R-F (NC-LB)	L	0	X	X	
	R	X	X	0	

3 Position Selector Switches

	Contact	Mounting Position	Operator Position		
			Left	Center	Right
HW1S-3T HW1K-3* HW1F-3	HW-U10-F (NO)	L	X	0	0
		R	0	0	X
	HW-U01-F (NC)	L	0	X	X
		R	X	X	0
	HW-U10R-F (NO-EM)	L	X	0	0
		R	0	0	X
HW-U01R-F (NC-LB)	L	0	X	X	
	R	X	X	0	

4 Position Selector Switches

	Contact	Mounting Position	Operator Position			
			1	2	3	4
HW1S-4T	HW-U10-F (NO)	L	X	0	0	0
		R	0	0	0	X
	HW-U01-F (NC)	L	0	0	X	0
		R	0	X	0	0
	HW-U10R-F (NO-EM)	L	X	X	0	X
		R	X	0	X	X
HW-U01R-F (NC-LB)	L	0	X	X	X	
	R	X	X	X	0	

5 Position Selector Switches

	Contact	Mounting Position	Operator Position				
			1	2	3	4	5
HW1S-5T	HW-U10-F (NO)	L	X	0	0	0	0
		R	0	0	0	0	X
	HW-U01-F (NC)	L	0	0	0	X	0
		R	0	X	0	0	0
	HW-U10R-F (NO-EM)	L	X	X	X	0	X
		R	X	0	X	X	X
HW-U01R-F (NC-LB)	L	0	X	X	X	X	
	R	X	X	X	X	0	

1. Mounting position indicates which side of operator each contact should be mounted (as viewed from the front of the panel).
2. *For key removable code see page 660.

3. HW1S-3T is identified by white plungers on the operator.
4. HW1S-3ST is identified by red plungers on the operator.
5. HW1S-3JT is identified by black plungers on the operator.

HW Safety Precautions

Turn off power to HW series control units before starting installation, removal, wiring, maintenance, and inspection of the products. Failure to turn power off may cause electrical shocks or fire hazard.

To avoid the possibility of burning yourself, use the lamp holder tool when replacing lamps.

For wiring, use wires of a proper size to meet voltage and current requirements.

HW General Instructions

Panel Mounting

Remove the contact block assembly from the operator (for transformer type pilot lights, remove the transformer from the illumination unit). Remove the locking ring from the operator. Insert the operator into the panel cut-out from the front, tighten the locking ring from the back, then install the contact block assembly to the operator.

Removing and Installing the Contact Block Assembly

1. To remove the operator from the contact block, turn the locking lever in the direction of the arrow shown below. The operator can now be removed.
2. To reinstall, place the TOP markings on the operator and the contact block mounting adapter in the same direction, and insert the operator into the contact block mounting adapter. Then turn the locking lever in the opposite direction.

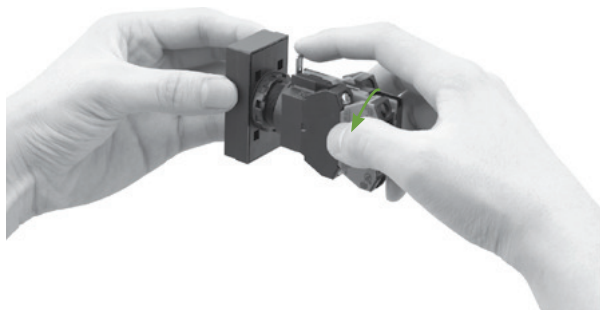

Notes for Panel Mounting

1. When mounting the operator onto a panel, use the optional locking ring wrench (MW9Z-T1) to tighten the locking ring. Tightening torque must not exceed 2.0 N·m. Do not use pliers. Excessive tightening will damage the locking ring.
2. For the contact blocks and transformers housing LED lamps, make sure not to press the lamps too hard, otherwise the lamp socket may be damaged.

Safety Lever Lock

IDEC strongly recommends using the safety lever lock (HW9Z-LS, yellow) to prevent heavy vibration or maintenance personnel from unlocking the contact assembly.

1. HW series can be mounted vertically with a minimum spacing of 55 mm but spacing should be determined to ensure easy operation (recommended minimum spacing: 100 mm).
2. Mount the control unit onto the panel, lock the lever, and push in the safety lever lock to install.
3. When the spacing is narrower than the recommended value, with the lever unlocked, mount the safety lever lock and insert the contact unit to the operator. Then, lock the lever and strongly push in the safety lever lock to install.
4. To remove the safety lever lock, insert a flat screwdriver into the safety lever and push upwards.

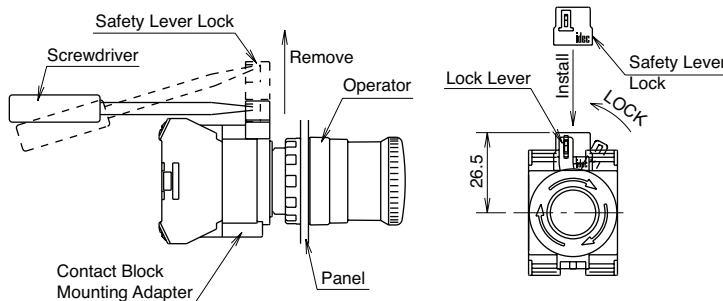

Dual Pushbutton Instructions

Replacement of Lens

Removing

Remove the lens by inserting a screwdriver into the recess of the lens through the bezel.

Installing

Install the lens in the recess between the buttons by pressing against the bezel.

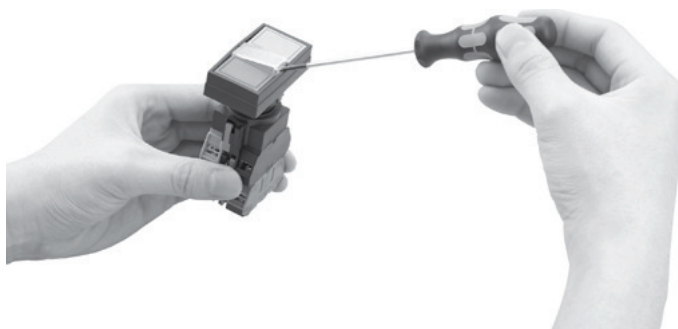

Dual Pushbuttons Instructions continued

Replacement of Lamps

LED lamps can be replaced by using the lamp holder tool (OR-55) from the front of the panel, or by removing the contact block assembly from the operator unit.

Removing the Lamps from the Front of the Panel

Removal

1. To remove, slip the lamp holder tool onto the lamp head lightly. Then push slightly, and turn the lamp holder tool counterclockwise.

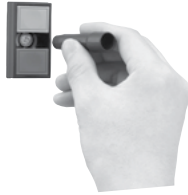

Installation

1. To install, insert the lamp head into the lamp holder tool, and hold the lamp as shown in the figure below.
2. Place the pins on the lamp base to the grooves in the lamp socket. Insert the lamp and turn it clockwise.

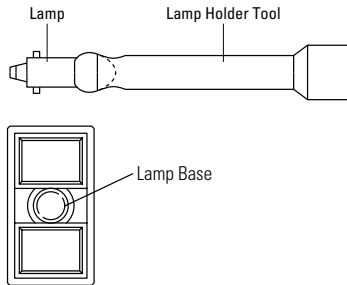

About Dual Pushbutton Switches

The dual pushbuttons cannot be removed or replaced!
Do not attempt to remove using a flat screwdriver or pincers, otherwise the dual pushbuttons may be damaged.

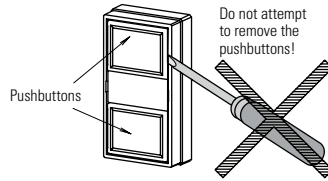

Narrow Mounting

When mounting the units closely in a horizontal row on 30mm centers, use optional barriers to prevent interconnection between adjoining terminals. The barriers can be attached simply by pressing them onto the sides of contact blocks.



When mounting transformer type illuminated units closely in a horizontal row on 30-mm centers, insert solid wires or stranded wires into inside of the terminal screw on the transformer (see figure on the right) to prevent short circuit between adjoining terminals.

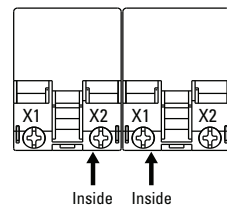

Installation of LED Illuminated Units

When using full voltage type LED illuminated units, provide protection against electrical noise, if necessary.

Applicable Wiring

The applicable wire size is 2 mm² maximum. (solid wire ø1.6mm² maximum) One or two wires can be connected.

Applicable Crimping Terminal

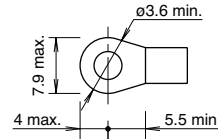

Be sure to use an insulation tube or cover on the crimping part of the crimping terminal to prevent electrical shocks.

Solid Wire

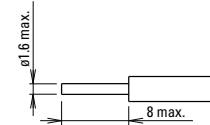

Note: When connecting wires to contact blocks or transformers in the direction shown below, keep the insulation stripping length 6.6 mm at the maximum.

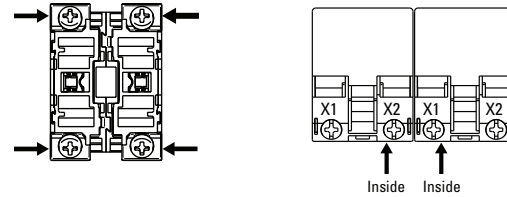

Installing the Rubber Boot

When using the HW7D pushbuttons in places where the pushbuttons are subjected to water splash or an excessive amount of dust, make sure to use the HW9Z-D7D rubber boot (IP65) which is ordered separately.

Notes for Installing the Rubber Boot

Remove the gasket from the operator, and install the rubber boot on the operator. Pull out the seals of the rubber boot and place them around the operator sleeve as shown. Make sure that the seals are not twisted or tucked inside and that the gasket does not remain, otherwise the normal waterproof and dustproof characteristics are not ensured.

1. Remove the gasket.
2. Install the rubber boot on the pushbuttons.
3. Rubber boot is installed.

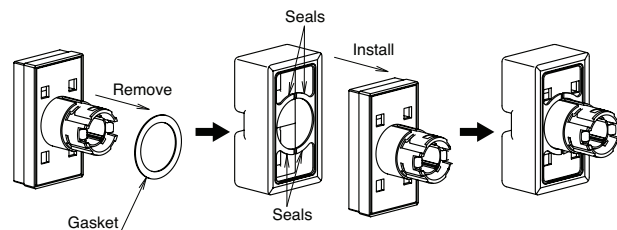

ø22 HW Series Push-in Switches & Pilot Lights

- Push-in terminal connection reduces wiring time.
- Safety enhanced with IP20 finger-safe protection.



File No. E68961

• See website for details on approvals and standards.

Note) Approvals for pushbuttons, selector switches, pilot lights only.

For illuminated/non-illuminated buzzer (page 775) and emergency stop switches (page 776), see each page.

Specifications and Ratings

Contact Ratings

Pushbuttons Illuminated Pushbuttons Dual Pushbuttons Selector Switches Key Selector Switches Illuminated Selector Switches Selector Pushbuttons Monolever Switches Emergency Stop Switches	Rated insulation voltage	600V
	Rated continuous current	10A
	Contact ratings by utilization category IEC60947-5-1	AC-15 (A600) DC-13

• See website for approved contact ratings.

Rated Operating Voltage and Current by Utilization Category

HW-P10 (NO contact), HW-P01 (NC contact), HW-PW20 (2NO contact), HW-PW11 (1NO-1NC contact), HW-PW02 (2NC contact)

Operating Voltage			24V	48V	50V	110V	220V	440V
Operating Current	AC 50/60 Hz	AC-12 Control of resistive loads and solid state loads	10A	-	10A	10A	6A	2A
		AC-15 Control of electromagnetic loads (> 72 VA)	10A	-	7A	5A	3A	1A
	DC	DC-12 Control of resistive loads and solid state loads	10A	5A	-	2.2A	1.1A	-
		DC-13 Control of electromagnets	5A	2A	-	1.1A	0.6A	-

- The operating current represents making and breaking currents (IEC 60947-5-1).
- Contact materials: Silver contacts
- Minimum applicable load: 3V AC/DC, 5 mA (applicable range may vary with operating conditions)

Push-in Contact Block (HW-P..)

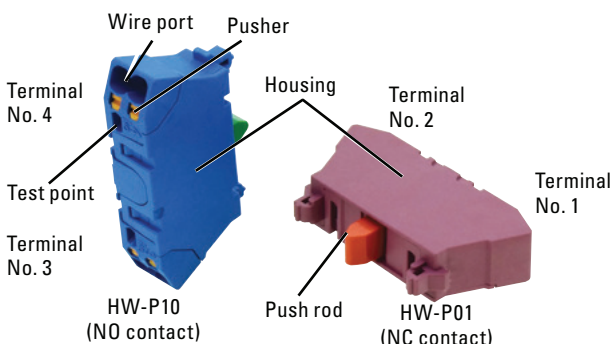

Contact	Single Contact Block		Double Contact Block		
	1NO	1NC	2NO	2NC	1NO-1NC
Part No.	HW-P10	HW-P01	HW-PW20	HW-PW02	HW-PW11
Shape					
Housing	Blue	Purple red	Blue	Purple red	Blue/Purple red
Push Rod	Green	Red	Green	Red	Light Blue
Contact No.	3-4	1-2	1st deck: 13-14 2nd deck: 23-24	1st deck: 11-12 2nd deck: 21-22	1st deck: 13-14 2nd deck: 21-22
Weight	8g		16g		

LED Illuminated Part Specifications

Illuminated Pushbuttons, Illuminated Selector Switches, Dual Pushbuttons (with pilot light)

Rated Voltage	Operating Voltage		LED Lamp	
			Ramp Base	Part No.
6V AC/DC	6V AC/DC	±10%	BA9S/13	LSRD-6
12V AC/DC	12V AC/DC			LSRD-1
24V AC/DC	24V AC/DC			LSRD-2
100/120V AC/DC	100/120V AC/DC			LSRD-H2
200/220V AC	200/220V AC			LSRD-M2
230/240V AC	230/240V AC	207-250V		LSRD-M4

Pilot Light (Short Body)

Rated Voltage	Operating Voltage		LED Lamp		
			Ramp Base	Part No.	
6V AC/DC	6V AC/DC	±10%	BA9S/13	LSRD-6	
12V AC/DC	12V AC/DC			LSRD-1	
24V AC/DC	24V AC/DC			LSRD-2	
100/120V AC	50/60Hz			100/120V AC	LSRD-6
200/240V AC	200/240V AC			200/240V AC	

LED Lamp Ratings

Part No.	LSRD-6	LSRD-1	LSRD-2	LSRD-H2	LSRD-M2	LSRD-M4
Ramp Base	BA9S/13					
Rated Voltage	6V AC/DC	12V AC/DC	24V AC/DC	100/120V AC/DC	200/220V AC	230/240V AC
Voltage Range	6V AC/DC ±10%	12V AC/DC ±10%	24V AC/DC ±10%	100/120V AC/DC ±10%	200/220V AC ±10%	230/240V AC ±10%
Current Draw	DC	10mA	7mA	7mA	2mA	2mA
	AC	14mA	8mA	8mA	2mA	2mA
Life (reference value)	Approx. 50,000 hours (The luminance is reduced to 50% the initial intensity when used on complete DC at 25°C.)					
Internal Circuit						

Direct Opening of Key Selector Switch

Applicable Type	2-position	3-position
Minimum Operator Angle for Direct Opening Action	60° (90° Maintained)	45°
Minimum Operator Torque for Direct Opening Action	0.4 N·m	
Maximum Operator Angle	60° (90° Maintained)	45°

Degree of Protection

IEC60529

Unit	IEC 60529
All models except illuminated selector switches, dual pushbuttons, pilot lights	IP65 (*1)
Illuminated selectors, pilot lights	IP65
Dual pushbuttons	IP40 (*2)

*1) When using a nameplate with the HW series, IP65 protection degree is achieved only when nameplates shown on page 780 are used.

(IP40 when other ø22 nameplates such as NWA are used)

*2) IP65 when used with button covers (HW9Z-D7D).

UL50

Unit	UL50
All models except illuminated selector switches	Type 4X (*3)(*4)

*3) When using a nameplate with the HW series, IP65 protection degree is achieved only when nameplates shown on page 780 are used.

*4) For dual pushbuttons, Type 4X is achieved when used with button covers (HW9Z-D7D).

Specifications

Switches (except for emergency stop switch)

Operating Temperature	-25 to +60°C (no freezing) Illuminated unit: -25 to +50°C
Operating Humidity	45 to 85% RH (no condensation)
Storage Temperature	-40 to +80°C (no freezing)
Contact Resistance	50 mΩ maximum (initial value)
Insulation Resistance	100 MΩ minimum (500V DC megger)
Overvoltage Category	II
Impulse Withstand Voltage	4.0kV Illuminated unit: 2.5kV
Pollution Degree	3 (IEC60947-5-1)
Dielectric Strength	Between live and dead parts: 2500V AC, 1 minute
Vibration Resistance	Damage limits: 30 Hz, amplitude 1.5 mm Operating extremes: 5 to 55Hz, amplitude 0.5 mm
Shock Resistance	Damage limits: 1,000 m/s ² Operating extremes: 100 m/s ²
Degree of Protection	Terminal: Finger-safe (IP20) structure Panel front: IP65 (IEC 60529), UL Type 4X
Recommended Tightening Torque for Locking Ring	2.0N·m
Terminal Style	Push-in terminal
Mechanical Life (minimum operations)	Pushbuttons, Illuminated Pushbuttons
	Momentary.....5,000,000 (*5)
1,000,000 (*6)
	Maintained.....500,000 (*5)
100,000 (*6)
	Dual pushbuttons.....500,000 (*5)
100,000 (*6)
	Selector switches.....500,000 (*5)
100,000 (*6)
	Key selector switches (Disc tumbler).....500,000 (*5)
100,000 (*6)
	Key selector switches (Pin tumbler).....100,000 (*5)
100,000 (*6)
	Illuminated selector switches.....500,000 (*5)
100,000 (*6)
Electrical Life (*5)	Pushbuttons, Illuminated Pushbuttons
	Momentary.....500,000 (*1)(*5)
50,000 (*1)(*6)
	Maintained.....500,000 (*3)(*5)
50,000 (*3)(*6)
	Dual pushbuttons.....500,000 (*1)(*5)
50,000 (*1)(*6)
	Selector switches.....500,000 (*2)(*5)
50,000 (*2)(*6)
	Key selector switches (Disc tumbler).....500,000 (*2)(*5)
50,000 (*2)(*6)
	Key selector switches (Pin tumbler).....100,000 (*2)(*5)
50,000 (*2)(*6)
	Illuminated selector switches.....500,000 (*2)(*5)
50,000 (*2)(*6)
Weight (approx.)	38g (HW1B-M1P11), 54g (HW1B-M1P22)
	38g (HW1S-2TP11), 54g (HW1S-2TP22)
	76g (HW1K-2AP11), 92g (HW1K-2AP22N2)
	66g (HW1K-2PCP11), 45g (HW1L-M1P11Q4)
	44g (HW1F-2P11Q4), 43g (HW1R-2AP11)
55g (HW1M-1010P-20), 45g (HW7D-B11P1001)	

*1) Switching frequency 1,800 operations/h, duty ratio 40%
 *2) Switching frequency 1,200 operations/h, duty ratio 40%
 *3) Switching frequency 900 operations/h, duty ratio 40%
 *4) Load condition 220V AC, 3A (AC-15)
 *5) Single contact block
 *6) Double contact block

Pilot lights

Operating Temperature	-25 to +50°C (no freezing)
Operating Humidity	45 to 85% RH (no condensation)
Storage Temperature	-40 to +80°C (no freezing)
Insulation Resistance	100 MΩ minimum (500V DC megger)
Overvoltage Category	II
Impulse Withstand Voltage	2.5kV
Pollution Degree	3
Dielectric Strength	Between live and dead parts: 2000V AC, 1 minute
Vibration Resistance	Damage limits: 30 Hz, amplitude 1.5 mm Operating extremes: 5 to 55Hz, amplitude 0.5 mm
Shock Resistance	Damage limits: 1,000 m/s ² Operating extremes: 100 m/s ²
Degree of Protection	Terminal: Finger-safe (IP20) structure Panel front: IP65 (IEC 60529), UL Type 4X
Recommended Tightening Torque for Locking Ring	2.0N·m
Terminal Style	Push-in terminal
Weight (approx.)	26g (HW1P-2JPQ4)
	27g (HW1P-2JPRH2)
	28g (HW1P-2JPCM2)

Mounting Hole Layout

(Dimensions in mm)

Panel Cut (IEC60947-5-1)

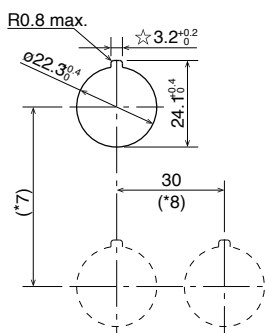

- When high temperature is expected, take necessary measures such as securing sufficient mounting centers or using a cooling fan.
- The 3.2 mm recess is for preventing rotation and is not necessary when the nameplate or anti-rotation ring is not used.

Minimum Mounting Centers

(Dimensions in mm)

Unit	Vertical (*7)	Horizontal (*8)
ø40mm mushroom buttons	50	40
Selector pushbuttons	50	50
Monolever switches	72	72
Pilot lights	50	30
Dual pushbuttons	55	30
Illuminated selector switches	50	50

- For emergency stop switch mounting centers, see page 776.
- Determine the mounting centers in consideration of the operation, wiring, and testing terminals.

Ordering Information

- Specify the Ordering No. when ordering.
When ordering, specify button color, lens color, key removal specification, or key number codes.
- Some combinations cannot be ordered. For details, contact IDEC.
- Nameplates and accessories for mono-lever switch are ordered separately. See page 780 to 785.

Illuminated / non-illuminated buzzer specifications: see page 775 Emergency stop switch specifications: see page 776

Pushbuttons

Assembled



Package Quantity: 1

Name / Shape	Operation	Contact Configuration	Part No. Coded	⑤ Color Code
Flush HW1B-M1 / HW1B-A1 HW1B-A1 / HW4B-A1	Momentary	1NO	HW1B-M1P10⑤ HW4B-M1P10⑤	B (black) G (green) R (red) Y (yellow) S (blue) W (white)
		1NC	HW1B-M1P01⑤ HW4B-M1P01⑤	
		1NO-1NC	HW1B-M1P11⑤ HW4B-M1P11⑤	
		2NO	HW1B-M1P20⑤ HW4B-M1P20⑤	
		2NC	HW1B-M1P02⑤ HW4B-M1P02⑤	
		2NO-2NC	HW1B-M1P22⑤ HW4B-M1P22⑤	
Extended HW1B-M2 / HW4B-M2	Momentary	1NO	HW1B-M2P10⑤ HW4B-M2P10⑤	
		1NC	HW1B-M2P01⑤ HW4B-M2P01⑤	
		1NO-1NC	HW1B-M2P11⑤ HW4B-M2P11⑤	

• For other configurations, select from sub-assembled units (page 13 to 14).

Pushbuttons Part No. Example

Assembled and sub-assembled unit

Assembled

HW1B - M 1 P 10 B

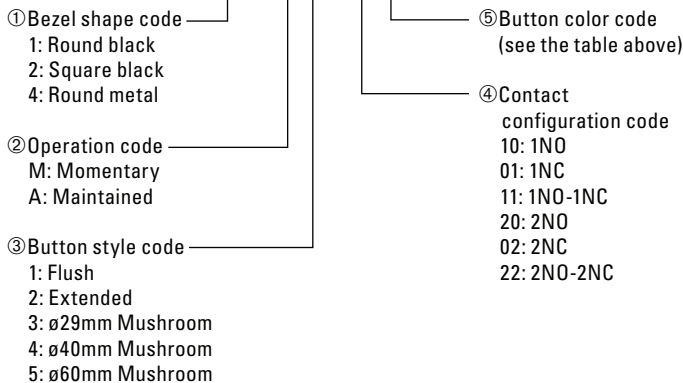

• For available assembled products, see above table.

Package Quantity: 1

Name / Shape	Operation	Contact Configuration	Part No. Coded	⑤ Color Code
ø60mm Mushroom HW1B-M5	Momentary	1NO	HW1B-M5P10⑤	B (black) G (green) R (red) Y (yellow) S (blue) * W (white) *
		1NC	HW1B-M5P01⑤	
ø40mm Mushroom HW1B-M4 / HW4B-M4	Momentary	1NO	HW1B-M4P10⑤ HW4B-M4P10⑤	* Not available for ø60mm
		1NC	HW1B-M4P01⑤ HW4B-M4P01⑤	
		1NC-1NC	HW1B-M4P11⑤ HW4B-M4P11⑤	

- Specify a button color code in place of ⑤ in the Part No.
- Pushbuttons with 1 contact block contain 2 dummy blocks. Pushbuttons with 2 contact blocks contain 1 dummy block.
- When requiring flush type maintained switches other than 1NO contact configuration, select from sub-assembled product.

Operator unit

MW1B - M 1 - B

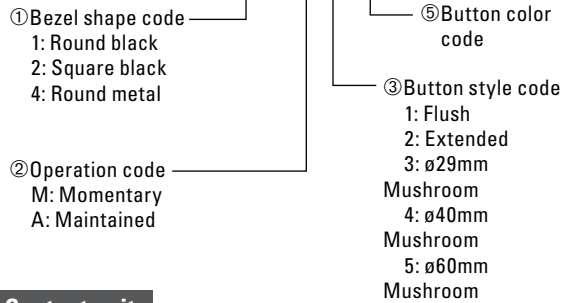

Contact unit

HW - CN P 10



Pushbuttons

Sub-Assembled

When ordering, specify the sub-assembled ordering no. See page 742 for available assembled products.



Sub-Assembled Ordering No.

Package Quantity: 1

Name / Shape	Operation	Contact Configuration	<Reference> Assembled Part No. ① = 1 or 4	Ⓢ Button Color Code
	Momentary	1NO	HW①B-M1P10⑤	B (black) G (green) R (red) Y (yellow) S (blue) W (white)
		1NC	HW①B-M1P01⑤	
		1NO-1NC	HW①B-M1P11⑤	
		2NO	HW①B-M1P20⑤	
		2NC	HW①B-M1P02⑤	
		2NO-2NC	HW①B-M1P22⑤	
	Maintained	1NO	HW①B-A1P10⑤	
		1NC	HW①B-A1P01⑤	
		1NO-1NC	HW①B-A1P11⑤	
		2NO	HW①B-A1P20⑤	
		2NC	HW①B-A1P02⑤	
		2NO-2NC	HW①B-A1P22⑤	
	Momentary	1NO	HW①B-M2P10⑤	B (black) G (green) R (red) Y (yellow) S (blue) W (white)
		1NC	HW①B-M2P01⑤	
		1NO-1NC	HW①B-M2P11⑤	
		2NO	HW①B-M2P20⑤	
		2NC	HW①B-M2P02⑤	
		2NO-2NC	HW①B-M2P22⑤	
	Maintained	1NO	HW①B-A2P10⑤	
		1NC	HW①B-A2P01⑤	
		1NO-1NC	HW①B-A2P11⑤	
		2NO	HW①B-A2P20⑤	
		2NC	HW①B-A2P02⑤	
		2NO-2NC	HW①B-A2P22⑤	
	Momentary	1NO	HW①B-M3P10⑤	B (black) G (green) R (red) Y (yellow) S (blue) W (white)
		1NC	HW①B-M3P01⑤	
		1NO-1NC	HW①B-M3P11⑤	
		2NO	HW①B-M3P20⑤	
		2NC	HW①B-M3P02⑤	
		2NO-2NC	HW①B-M3P22⑤	
	Maintained	1NO	HW①B-A3P10⑤	
		1NC	HW①B-A3P01⑤	
		1NO-1NC	HW①B-A3P11⑤	
		2NO	HW①B-A3P20⑤	
		2NC	HW①B-A3P02⑤	
		2NO-2NC	HW①B-A3P22⑤	

Operator Unit	
Name / Shape	Part No.
	HW①B-M1-⑤
	HW①B-A1-⑤
	HW①B-M2-⑤
	HW①B-A2-⑤
	HW①B-M3-⑤
	HW①B-A3-⑤

Contact Unit		
Shape	Contact Configuration	Part No. (Ordering No.)
	1NO	HW-CNP10
	1NC	HW-CNP01
	1NO-1NC	HW-CNP11
	2NO	HW-CNP20
	2NC	HW-CNP02
	2NO-2NC	HW-CNP22
	1NO	HW-CNP10
	1NC	HW-CNP01
	1NO-1NC	HW-CNP11
	2NO	HW-CNP20
	2NC	HW-CNP02
	2NO-2NC	HW-CNP22

- Specify a bezel type code in place of ① in the Part No. See page 12.
- Specify a button color code in place of Ⓢ in the Part No.
B (black), G (green), R (red), Y (yellow), S (blue), W (white)

For Part No. (Ordering No.)/ mounting positions of contact units, see page 781.





Pushbuttons





Sub-Assembled





When ordering, specify the sub-assembled ordering no. See page 742 for available assembled products.

Sub-Assembled Ordering No.

Package Quantity: 1

Name / Shape	Operation	Contact Configuration	<Reference> Assembled Part No. ① = 1 or 4	⑤ Button Color Code			
 ø40mm Mushroom	Momentary	1NO	HW①B-M4P10⑤	B (black) G (green) R (red) Y (yellow) S (blue) W (white)			
		1NC	HW①B-M4P01⑤				
		1NO-1NC	HW①B-M4P11⑤				
		2NO	HW①B-M4P20⑤				
		2NC	HW①B-M4P02⑤				
		2NO-2NC	HW①B-M4P22⑤				
	Maintained	1NO	HW①B-A4P10⑤				
		1NC	HW①B-A4P01⑤				
		1NO-1NC	HW①B-A4P11⑤				
		2NO	HW①B-A4P20⑤				
		2NC	HW①B-A4P02⑤				
		2NO-2NC	HW①B-A4P22⑤				
 ø60mm Mushroom	Momentary	1NO	HW1B-M5P10⑤	B (black) G (green) R (red) Y (yellow)			
		1NC	HW1B-M5P01⑤				
		1NO-1NC	HW1B-M5P11⑤				
		2NO	HW1B-M5P20⑤				
		2NC	HW1B-M5P02⑤				
		2NO-2NC	HW1B-M5P22⑤				
		 Square Flush	Momentary		1NO	HW2B-M1P10⑤	B (black) G (green) R (red) Y (yellow) S (blue) W (white)
1NC	HW2B-M1P01⑤						
1NO-1NC	HW2B-M1P11⑤						
2NO	HW2B-M1P20⑤						
2NC	HW2B-M1P02⑤						
2NO-2NC	HW2B-M1P22⑤						
Maintained	1NO		HW2B-A1P10⑤				
	1NC		HW2B-A1P01⑤				
	1NO-1NC		HW2B-A1P11⑤				
	2NO		HW2B-A1P20⑤				
	2NC		HW2B-A1P02⑤				
	2NO-2NC		HW2B-A1P22⑤				
	 Square Extended		Momentary	1NO	HW2B-M2P10⑤	B (black) G (green) R (red) Y (yellow) S (blue) W (white)	
				1NC	HW2B-M2P01⑤		
1NO-1NC		HW2B-M2P11⑤					
2NO		HW2B-M2P20⑤					
2NC		HW2B-M2P02⑤					
Maintained		1NO	HW2B-A2P10⑤				
		1NC	HW2B-A2P01⑤				
		1NO-1NC	HW2B-A2P11⑤				
		2NO	HW2B-A2P20⑤				
		2NC	HW2B-A2P02⑤				
2NO-2NC	HW2B-A2P22⑤						

Operator Unit	
Name / Shape	Part No.
 ø40mm Mushroom	HW①B-M4-⑤ HW①B-A4-⑤
 ø60mm Mushroom	HW1B-M5-⑤ (*1)
 Square Flush	HW2B-M1-⑤ HW2B-A1-⑤
 Square Extended	HW2B-M2-⑤ HW2B-A2-⑤

Contact Unit		
Shape	Contact Configuration	Part No. (Ordering No.)
	1NO	HW-CNP10
	1NC	HW-CNP01
	1NO-1NC	HW-CNP11
	2NO	HW-CNP20
	2NC	HW-CNP02
	2NO-2NC	HW-CNP22
	1NO	HW-CNP10
	1NC	HW-CNP01
	1NO-1NC	HW-CNP11
	2NO	HW-CNP20
	2NC	HW-CNP02
	2NO-2NC	HW-CNP22
	1NO	HW-CNP10
	1NC	HW-CNP01
	1NO-1NC	HW-CNP11
	2NO	HW-CNP20
	2NC	HW-CNP02
	2NO-2NC	HW-CNP22
	1NO	HW-CNP10
	1NC	HW-CNP01
	1NO-1NC	HW-CNP11
	2NO	HW-CNP20
	2NC	HW-CNP02
	2NO-2NC	HW-CNP22

- Specify a bezel type code in place of ① in the Part No. See page 742.
- Specify a button color code in place of ⑤ in the Part No.
 B (black), G (green), R (red), Y (yellow), S (blue), W (white)
- *1) Only B (black), G (green), R (red), Y (yellow) available for ø60mm mushroom.
 The anti-rotation ring P/N: HW9Z-RL is **not** included with the operator and can be purchased separately.

For Part No. (Ordering No.)/ mounting positions of contact units, see page 781.

Pushbuttons Dimensions

All dimensions in mm.

Flush

1 to 2 contacts

HW1B-□1P

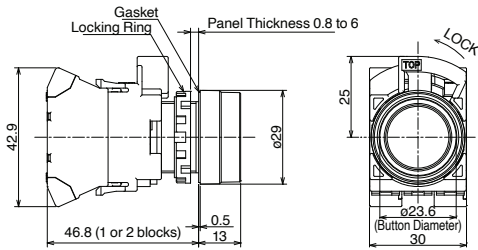

3 to 4 contacts

HW1B-□1P

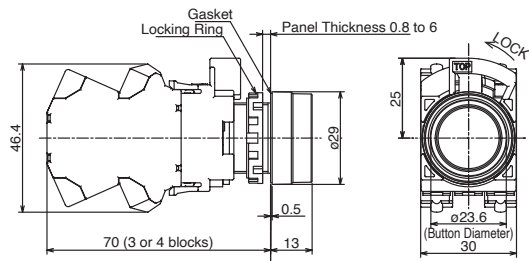

Extended

1 to 2 contacts

HW1B-□2P

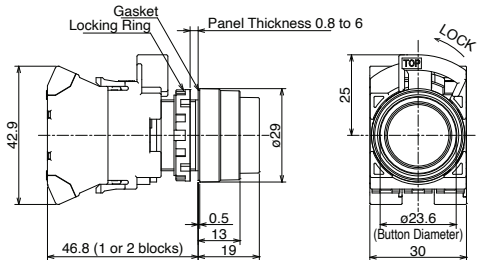

3 to 4 contacts

HW1B-□2P

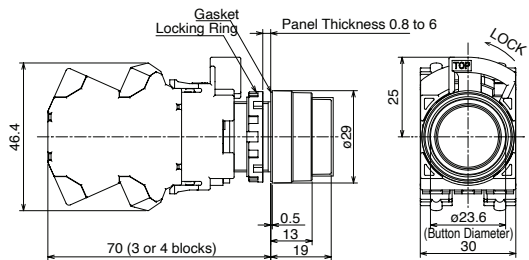

ø29mm Mushroom

1 to 2 contacts

HW1B-□3P

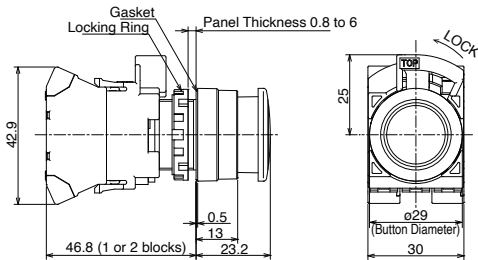

3 to 4 contacts

HW1B-□3P

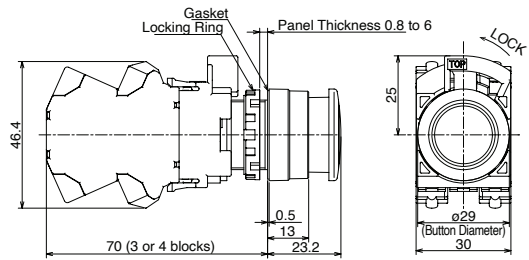

ø40mm Mushroom

1 to 2 contacts

HW1B-□4P

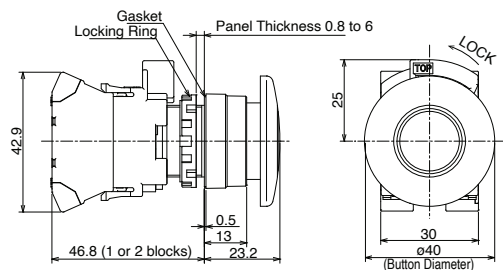

3 to 4 contacts

HW1B-□4P

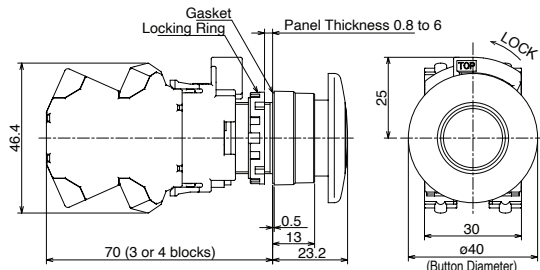

Pushbuttons Dimensions

All dimensions in mm.

ø60mm Mushroom

1 to 2 contacts
HW1B-M5P

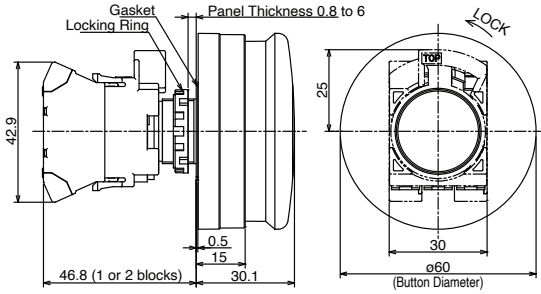

3 to 4 contacts
HW1B-M5P

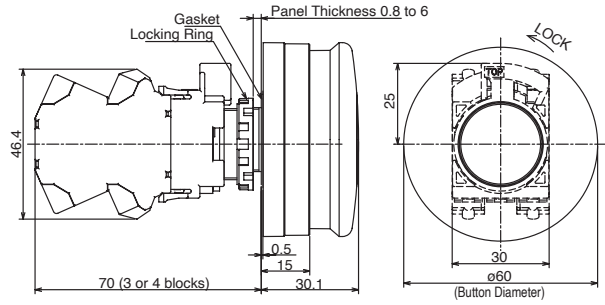

Square Flush

1 to 2 contacts
HW2B-□1P

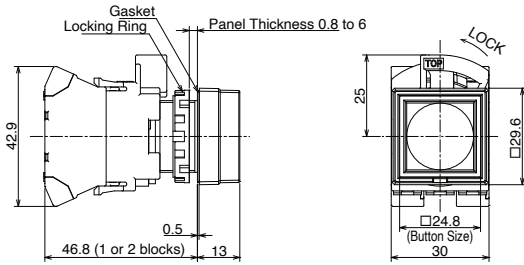

3 to 4 contacts
HW2B-□1P

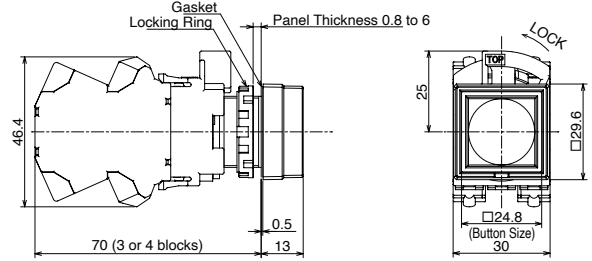

Square Extended

1 to 2 contacts
HW2B-□2P

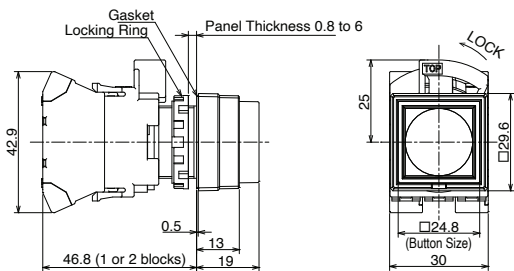

3 to 4 contacts
HW2B-□2P

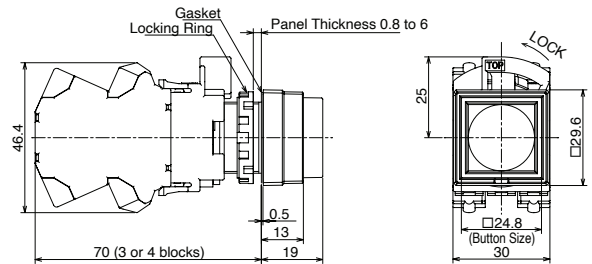

Illuminated Pushbuttons

Assembled



Package Quantity: 1

Name / Shape	Operation	Rated Voltage	Contact Configuration	Part No. (coded) ① = 1 or 4	⑥ Illumination Color Code
Round Flush (marking) HW1L-M1 HW1L-A1 HW4L-M1 HW4L-A1 	Momentary	24V AC/DC	1NO	HW①L-M1P10Q4⑥	R (red) G (green) Y (yellow) A (amber) S (blue) PW (pure white)
			1NO-1NC	HW①L-M1P11Q4⑥	
		100/120V AC/DC	1NO	HW①L-M1P10QH2⑥	
	Maintained	24V AC/DC	1NO	HW①L-A1P10Q4⑥	
			1NO-1NC	HW①L-A1P11Q4⑥	
			2NO	HW①L-A1P20Q4⑥	
Round Extended (marking) HW1L-M2 / HW4L-M2 	Momentary	24V AC/DC	1NO	HW①L-M2P10Q4⑥	R (red) G (green) Y (yellow) A (amber) S (blue) PW (pure white)
			1NO-1NC	HW①L-M2P11Q4⑥	
Round Extended with Full Shroud (marking) HW1L-MF2 	Momentary	24V AC/DC	1NO	HW①L-MF2P10Q4⑥	R (red) G (green) Y (yellow) A (amber) S (blue) PW (pure white)
		100/120V AC/DC	1NO	HW①L-MF2P10QH2⑥	
Square Flush (marking) HW2L-M1 	Momentary	24V AC/DC	1NO	HW2L-M1P10Q4⑥	R (red) G (green) Y (yellow) A (amber) S (blue) PW (pure white)
			1NO-1NC	HW2L-M1P11Q4⑥	

- Specify a bezel type code in place of ① in the Part No. See page 742.
- Specify an illumination color code in place of ⑥ in the Part No.

• For other configurations, select from sub-assembled units (page 748 to 749).

Illuminated Pushbuttons

Sub-Assembled

When ordering, specify the sub-assembled ordering no. See page 747 for available assembled products.

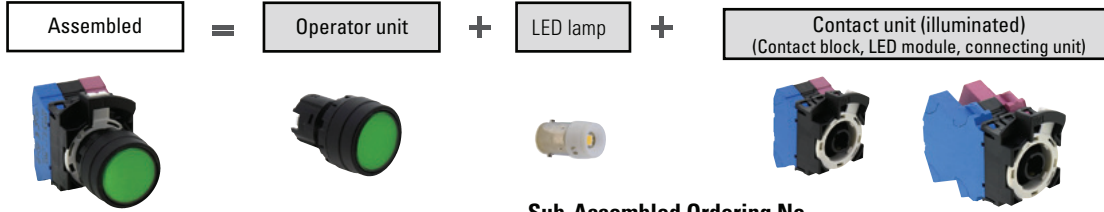

Name / Shape	Operation	Contact Configuration	<Reference> Assembled Part No. ① = 1 or 4	⑥ Illumination Color Code
Round Flush (marking)	Momentary	1NO	HW①L-M1P10⑤⑥	R (red) G (green) Y (yellow) A (amber) S (blue) PW (pure white)
		1NC	HW①L-M1P01⑤⑥	
		1NO-1NC	HW①L-M1P11⑤⑥	
		2NO	HW①L-M1P20⑤⑥	
		2NC	HW①L-M1P02⑤⑥	
	Maintained	2NO-2NC	HW①L-M1P22⑤⑥	
		1NO	HW①L-A1P10⑤⑥	
		1NC	HW①L-A1P01⑤⑥	
		1NO-1NC	HW①L-A1P11⑤⑥	
		2NO	HW①L-A1P20⑤⑥	
Round Extended (marking)	Momentary	2NC	HW①L-A1P02⑤⑥	
		2NO-2NC	HW①L-A1P22⑤⑥	
		1NO	HW①L-M2P10⑤⑥	
		1NC	HW①L-M2P01⑤⑥	
		1NO-1NC	HW①L-M2P11⑤⑥	
	Maintained	2NO	HW①L-M2P20⑤⑥	
		2NC	HW①L-M2P02⑤⑥	
		2NO-2NC	HW①L-M2P22⑤⑥	
		1NO	HW①L-A2P10⑤⑥	
		1NC	HW①L-A2P01⑤⑥	
Round Extended with Full Shroud (marking)	Momentary	1NO-1NC	HW①L-A2P11⑤⑥	R (red) G (green) Y (yellow) A (amber) S (blue) PW (pure white)
		2NO	HW①L-A2P20⑤⑥	
		2NC	HW①L-A2P02⑤⑥	
		2NO-2NC	HW①L-A2P22⑤⑥	
		1NO	HW①L-MF2P10⑤⑥	
	Maintained	1NC	HW①L-MF2P01⑤⑥	
		1NO-1NC	HW①L-MF2P11⑤⑥	
		2NO	HW①L-MF2P20⑤⑥	
		2NC	HW①L-MF2P02⑤⑥	
		2NO-2NC	HW①L-MF2P22⑤⑥	
Maintained	1NO	HW①L-AF2P10⑤⑥		
	1NC	HW①L-AF2P01⑤⑥		
	1NO-1NC	HW①L-AF2P11⑤⑥		
	2NO	HW①L-AF2P20⑤⑥		
	2NC	HW①L-AF2P02⑤⑥		
2NO-2NC	HW①L-AF2P22⑤⑥			

Sub-Assembled Ordering No.

Operator unit	
Name / Shape	<Reference> Assembled Part No. ① = 1 or 4
Round Flush (marking)	HW①L-M1⑥-PI-USA
Round Extended (marking)	HW①L-M2⑥-PI-USA
Round Extended with Full Shroud (marking)	HW①L-MF2⑥-PI-USA
	HW①L-A1⑥-PI-USA
	HW①L-A2⑥-PI-USA
	HW①L-AF2⑥-PI-USA

Package Quantity: 1

Contact Unit		
Shape	Contact Configuration	Part No. (Ordering No.)
	1NO	HW-CNP10Q0
	1NC	HW-CNP01Q0
	1NO-1NC	HW-CNP11Q0
	2NO	HW-CNP20Q0
	2NC	HW-CNP02Q0
	2NO-2NC	HW-CNP22Q0
	1NO	HW-CNP10Q0
	1NC	HW-CNP01Q0
	1NO-1NC	HW-CNP11Q0
	2NO	HW-CNP20Q0
	2NC	HW-CNP02Q0
	2NO-2NC	HW-CNP22Q0
	1NO	HW-CNP10Q0
	1NC	HW-CNP01Q0
	1NO-1NC	HW-CNP11Q0
	2NO	HW-CNP20Q0
	2NC	HW-CNP02Q0
	2NO-2NC	HW-CNP22Q0
	1NO	HW-CNP10Q0
	1NC	HW-CNP01Q0

- Specify a bezel type code in place of ① in the Part No. See page 742.
- Specify a rated voltage code in place of ⑤ in the Part No.

Code	Rated voltage	Code	Rated voltage
Q2	6V AC/DC	QH2	100/120V AC/DC
Q3	12V AC/DC	QM	200/220V AC
Q4	24V AC/DC	QM4	230/240V AC



- Specify an illumination color code in place of ⑥ in the Part No.
R (red), G (green), Y (yellow), A (amber), S (blue), PW (pure white)

Note) LED lamp is not supplied. When ordering contact units (illuminated) selected LED from below table.

LED lamp (package quantity:1)	
Rated Voltage	Part No. (Ordering No.)
6V AC/DC	LSRD-6
12V AC/DC	LSRD-1
24V AC/DC	LSRD-2
100/120V AC/DC	LSRD-H2
200/220V AC	LSRD-M2
230/240V AC	LSRD-M4

For Part No. (Ordering No.) / mounting positions of contact units, see page 782.

Illuminated Pushbuttons

Name / Shape	Operation	Contact Configuration	<Reference> Assembled Part No. ① = 1 or 4	⑥ Color Code
Square Flush (marking) 	Momentary	1NO	HW2L-M1P10⑤⑥	R (red) G (green) Y (yellow) A (amber) S (blue) PW (pure white)
		1NC	HW2L-M1P01⑤⑥	
		1NO-1NC	HW2L-M1P11⑤⑥	
		2NO	HW2L-M1P20⑤⑥	
		2NC	HW2L-M1P02⑤⑥	
	Maintained	1NO	HW2L-A1P10⑤⑥	
		1NC	HW2L-A1P01⑤⑥	
		1NO-1NC	HW2L-A1P11⑤⑥	
		2NO	HW2L-A1P20⑤⑥	
		2NC	HW2L-A1P02⑤⑥	
ø29 Mushroom (marking) 	Momentary	1NO	HW①L-M3P10⑤⑥	R (red) G (green) Y (yellow) A (amber) S (blue) PW (pure white)
		1NC	HW①L-M3P01⑤⑥	
		1NO-1NC	HW①L-M3P11⑤⑥	
		2NO	HW①L-M3P20⑤⑥	
		2NC	HW①L-M3P02⑤⑥	
	Maintained	1NO	HW①L-A3P10⑤⑥	
		1NC	HW①L-A3P01⑤⑥	
		1NO-1NC	HW①L-A3P11⑤⑥	
		2NO	HW①L-A3P20⑤⑥	
		2NC	HW①L-A3P02⑤⑥	
ø40 Jumbo Mushroom (marking) 	Momentary	1NO	HW①L-M4P10⑤⑥	R (red) G (green) Y (yellow) A (amber) S (blue) PW (pure white)
		1NC	HW①L-M4P01⑤⑥	
		1NO-1NC	HW①L-M4P11⑤⑥	
		2NO	HW①L-M4P20⑤⑥	
		2NC	HW①L-M4P02⑤⑥	
	Maintained	1NO	HW①L-A4P10⑤⑥	
		1NC	HW①L-A4P01⑤⑥	
		1NO-1NC	HW①L-A4P11⑤⑥	
		2NO	HW①L-A4P20⑤⑥	
		2NC	HW①L-A4P02⑤⑥	

- Specify a bezel type code in place of ① in the Part No. See page 742.
- Specify a rated voltage code in place of ⑤ in the Part No.

Code	Rated voltage	Code	Rated voltage
Q2	6V AC/DC	QH2	100/120V AC/DC
Q3	12V AC/DC	QM	200/220V AC
Q4	24V AC/DC	QM4	230/240V AC

- Specify an illumination color code in place of ⑥ in the Part No.
R (red), G (green), Y (yellow), A (amber), S (blue), PW (pure white)

Sub-Assembled Ordering No.

Operator unit	
Name / Shape	<Reference> Assembled Part No. ① = 1 or 4
Square Flush (marking) 	HW2L-M1⑥-PI-USA
ø29 Mushroom (marking) 	HW①L-M3⑥-PI-USA
ø40 Jumbo Mushroom (marking) 	HW①L-M4⑥-PI-USA

Package Quantity: 1

Contact Unit		
Shape	Contact Configuration	Part No. (Ordering No.)
	1NO	HW-CNP10Q0
	1NC	HW-CNP01Q0
	1NO-1NC	HW-CNP11Q0
	2NO	HW-CNP20Q0
	2NC	HW-CNP02Q0
	2NO-2NC	HW-CNP22Q0
	1NO	HW-CNP10Q0
	1NC	HW-CNP01Q0
	1NO-1NC	HW-CNP11Q0
	2NO	HW-CNP20Q0
	2NC	HW-CNP02Q0
	2NO-2NC	HW-CNP22Q0
	1NO	HW-CNP10Q0
	1NC	HW-CNP01Q0
	1NO-1NC	HW-CNP11Q0
	2NO	HW-CNP20Q0
	2NC	HW-CNP02Q0
	2NO-2NC	HW-CNP22Q0
	1NO	HW-CNP10Q0
	1NC	HW-CNP01Q0
	1NO-1NC	HW-CNP11Q0
	2NO	HW-CNP20Q0
	2NC	HW-CNP02Q0
	2NO-2NC	HW-CNP22Q0

Note) LED lamp is not supplied. When ordering contact units (illuminated) selected LED from below table.

LED lamp (package quantity:1)	
Rated Voltage	Part No. (Ordering No.)
6V AC/DC	LSRD-6
12V AC/DC	LSRD-1
24V AC/DC	LSRD-2
100/120V AC/DC	LSRD-H2
200/220V AC	LSRD-M2
230/240V AC	LSRD-M4

For Part No. (Ordering No.) / mounting positions of contact units, see page 782.

Illuminated Pushbuttons Dimensions

All dimensions in mm.

Round Flush

1 to 2 contacts

HW1L-□1P

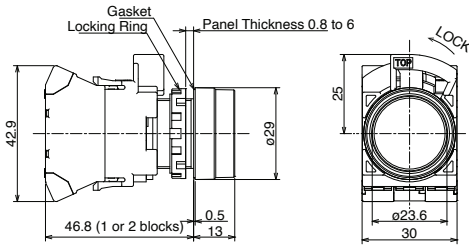

3 to 4 contacts

HW1L-□1P

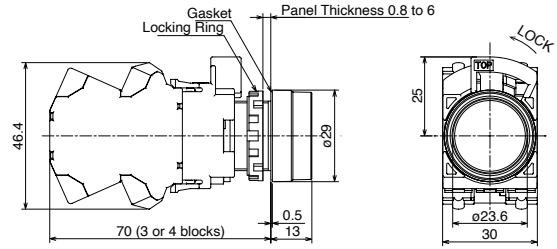

Round Extended

1 to 2 contacts

HW1L-□2P

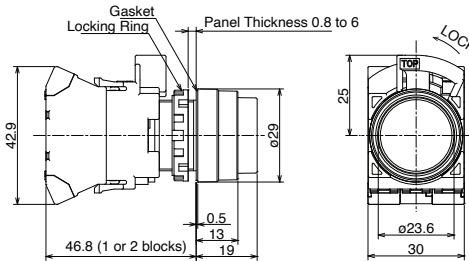

3 to 4 contacts

HW1L-□2P

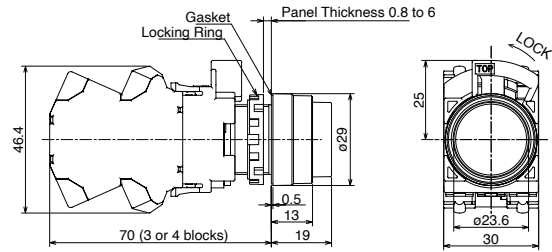

Round Extended with Full Shroud

1 to 2 contacts

HW1L-□F2P

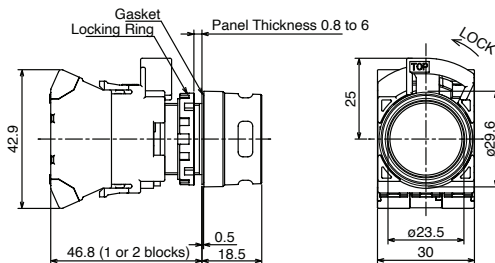

3 to 4 contacts

HW1L-□F2P

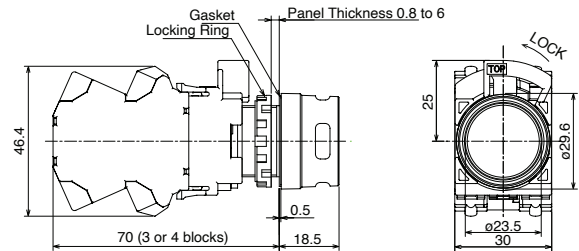

Square Flush

1 to 2 contacts

HW2L-□1P

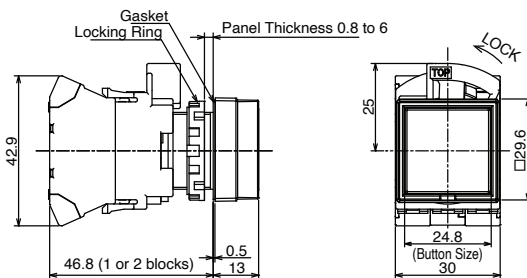

3 to 4 contacts

HW2L-□1P

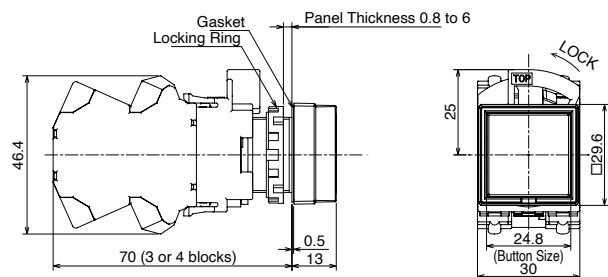

Illuminated Pushbuttons Dimensions

All dimensions in mm.

ø29 Mushroom

1 to 2 contacts

HW1L-□3P

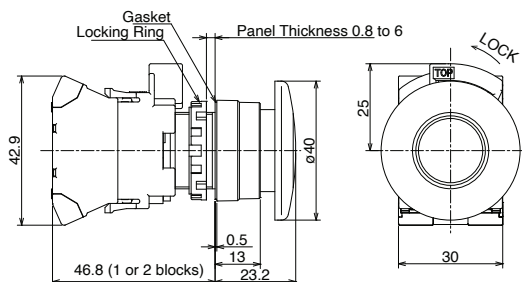

3 to 4 contacts

HW1L-□3P

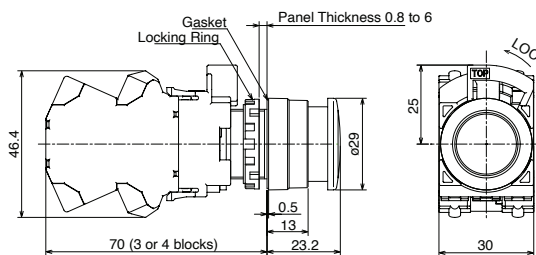

ø40 Jumbo Mushroom

1 to 2 contacts

HW1L-□4P

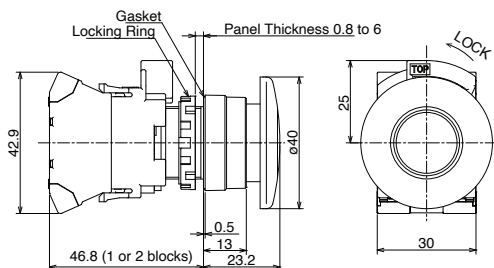

3 to 4 contacts

HW1L-□4P

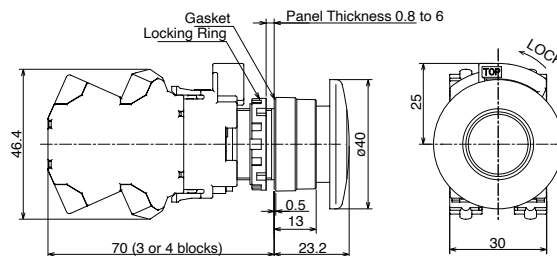

Illuminated Pushbuttons Part No. Example
Assembled and sub-assembled unit

Assembled

HW1L - M 1 P 11 Q4 R

- ① Bezel shape code
1: Round black
2: Square black
4: Round Metal
- ② Operation code
M: Momentary
A: Maintained
- ③ Button style code
1: Flush
2: Extended
F2: Round Extended with full Shroud
3: ø29mm Mushroom
4: ø40mm Mushroom
- ④ Contact configuration code
10: 1NO
01: 1NC
11: 1NO1NC
20: 2NO
02: 2NC
22: 2NO-2NC
- ⑤ Rated voltage code
Q2 : 6V AC/DC
Q3 : 12V AC/DC
Q4 : 24V AC/DC
QH2: 100/120V AC/DC
QM : 200/220V AC
QM4 : 230/240V AC
- ⑥ Button color code (see page 747)

Operator unit

HW1L - M 1 R - PI-USA

- ① Bezel shape code
1: Round black
2: Square black
4: Round metal
- ② Operation code
M: Momentary
A: Maintained
- ③ Button style code
1: Flush
2: Extended
F2: Round Extended with full Shroud
3: ø29mm Mushroom
4: ø40mm Mushroom
- ⑥ Button color code (see page 748 & 749)

Contact unit (illuminated)

HW - CN P 10 Q0

• LED lamps are not supplied.

LED lamp

LSRD - 6

• For available assembled products, see table on page 747.

- ⑤ Rated voltage code
6 : 6V AC/DC
1 : 12V AC/DC
2 : 24V AC/DC
H2 : 100/120V AC/DC
M2: 200/220V AC
M4: 230/240V AC

Dual Pushbuttons without Pilot Light

Sub-Assembled

Dual pushbuttons can be purchased only as a sub-assembled product.



Without Pilot Light

Sub-Assembled Ordering No.

Package Quantity: 1

<Reference>				
Operation	Button style	Contact Configuration		<Reference> Assembled Part No
		Top Button	Bottom Button	
Momentary	Flush-Flush	1NO	1NC	HW7D-B11P1001⑥⑦
		1NO	1NO	HW7D-B11P1010⑥⑦
		1NO-1NC	1NO-1NC	HW7D-B11P1111⑥⑦
	Flush-Extended	2NO	2NC	HW7D-B11P2002⑥⑦
		1NO	1NC	HW7D-B12P1001⑥⑦
		1NO	1NO	HW7D-B12P1010⑥⑦
Interlocking (*1)	Flush-Flush	1NO	1NC	HW7D-B21P1001⑥⑦
		1NO	1NO	HW7D-B21P1010⑥⑦
		1NO-1NC	1NO-1NC	HW7D-B21P1111⑥⑦
		2NO	2NC	HW7D-B21P2002⑥⑦
	Flush-Extended	1NO	1NC	HW7D-B22P1001⑥⑦
		1NO	1NO	HW7D-B22P1010⑥⑦
		1NO-1NC	1NO-1NC	HW7D-B22P1111⑥⑦
		2NO	2NC	HW7D-B22P2002⑥⑦

Operator Unit Part No. (Ordering No.)
HW7D-B11⑥⑦
HW7D-B12⑥⑦
HW7D-B21⑥⑦
HW7D-B22⑥⑦

Contact Unit		
Contact Configuration		Part No. (Ordering No.)
Top Button	Bottom Button	
1NO	1NC	HW-CNP11
1NO	1NO	HW-CNP20
1NO-1NC	1NO-1NC	HW-CNP22
2NO	2NC	HW-CNP22N1
1NO	1NC	HW-CNP11
1NO	1NO	HW-CNP20
1NO-1NC	1NO-1NC	HW-CNP22
2NO	2NC	HW-CNP22N1

*1) Interlock: Momentary operation. When one of the buttons is pressed, the other button cannot be operated. Do not operate top and bottom buttons at the same time. Operating the buttons at the same time may lead to malfunctions.

- For contact mounting position, see page 781.
- Specify a code in place of ⑥⑦ in the Part No. See tables below

⑥ Button Color Code

Code	
GR	Top Button Green Bottom Button Red
WB	Top Button White Bottom Button Black

⑦ Button Legends Code

Code	
Blank	Blank
1	Top Button: I & ON / Bottom Button: O & OFF

Contact Configuration

Contact Configuration			Contact Block		Top Button		Bottom Button	
Top Button	Bottom Button	Code	Mounting Position	Contact	Nomal	Push	Nomal	Push
1NO	1NC	1001	(1)	NO		X		
			(3)	NC			X	
1NO	1NO	1010	(1)	NO		X		
			(3)	NO				X
1NO-1NC	1NO-1NC	1111	(1)	NONC	NO	X		
			(3)	NONC	NO			X
2NO	2NC	2002	(1)	2NO		X		
			(3)	2NC				X

← Button Position
← Pushbutton Operation

Contact Block Mounting Position

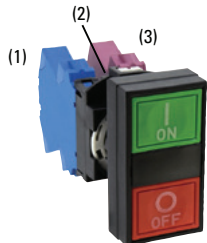

Note) (2) can only be mounted with a dummy block.

Contact block (1) is actuated by the top button.
Contact block (3) is actuated by the bottom button.

For Part No. (Ordering No.)/ mounting positions of contact units, see page 781.

Dual Pushbuttons with Pilot Light

Sub-Assembled

Dual pushbuttons can be purchased only as a sub-assembled product.



With Pilot Light

Sub-Assembled Ordering No.

Package Quantity: 1

<Reference>				
Operation	Button Style	Contact Configuration		<Reference> Assembled Part No
		Top Button	Bottom Button	
Momentary	Flush-Flush	1NO	1NC	HW7D-L11P1001PW⑥⑦
		1NO	1NO	HW7D-L11P1010PW⑥⑦
		1NO-1NC	1NO-1NC	HW7D-L11P1111PW⑥⑦
		2NO	2NC	HW7D-L11P2002PW⑥⑦
	Flush-Extended	1NO	1NC	HW7D-L12P1001PW⑥⑦
		1NO	1NO	HW7D-L12P1010PW⑥⑦
		1NO-1NC	1NO-1NC	HW7D-L12P1111PW⑥⑦
		2NO	2NC	HW7D-L12P1010PW⑥⑦
Interlocking (*1)	Flush-Flush	1NO	1NC	HW7D-L21P1001PW⑥⑦
		1NO	1NO	HW7D-L21P1010PW⑥⑦
		1NO-1NC	1NO-1NC	HW7D-L21P1111PW⑥⑦
		2NO	2NC	HW7D-L21P2002PW⑥⑦
	Flush-Extended	1NO	1NC	HW7D-L22P1001PW⑥⑦
		1NO	1NO	HW7D-L22P1010PW⑥⑦
		1NO-1NC	1NO-1NC	HW7D-L22P1111PW⑥⑦
		2NO	2NC	HW7D-L22P2002PW⑥⑦

Operator Unit
Part No. (Ordering No.)
HW7D-L11⑥⑦
HW7D-L12⑥⑦
HW7D-L21⑥⑦
HW7D-L22⑥⑦

Contact Unit		
Contact Configuration		Part No. (Ordering No.)
Top Button	Bottom Button	
1NO	1NC	HW-CNP11Q0
1NO	1NO	HW-CNP20Q0
1NO-1NC	1NO-1NC	HW-CNP22Q0
2NO	2NC	HW-CNP22N1Q0
1NO	1NC	HW-CNP11Q0
1NO	1NO	HW-CNP20Q0
1NO-1NC	1NO-1NC	HW-CNP22Q0
2NO	2NC	HW-CNP22N1Q0

*1) Interlock: Momentary operation. When one of the buttons is pressed, the other button cannot be operated.

- Do not operate top and bottom buttons at the same time. Operating the buttons at the same time may lead to malfunctions.
- For contact mounting position, see page 782.
- Specify a code in place of ⑥⑦ in the Part No. See tables below

Code	Rated Voltage	Code	Rated Voltage
Q2	6V AC/DC	QH2	100/120V AC/DC
Q3	12V AC/DC	QM	200/220V AC
Q4	24V AC/DC	QM4	230/240V AC

⑥ Button Color Code

Code	
GR	Top Button Green Bottom Button Red
WB	Top Button White Bottom Button Black

⑦ Button Legends Code

Code	
Blank	Blank
1	Top Button: I & ON / Bottom Button: O & OFF

Contact Block Mounting Position

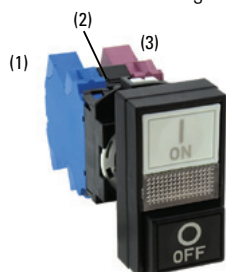

Note) (2) can only be mounted with a full voltage adapter.

For Part No. (Ordering No.)/ mounting positions of contact units, see page 782.

Note) LED lamp is not supplied. When ordering contact units (illuminated) selected LED from below table.

LED lamp (Package Quantity: 1)	
Rated Voltage	Part No. (Ordering No.)
6V AC/DC	LSRD-6
12V AC/DC	LSRD-1
24V AC/DC	LSRD-2
100/120V AC/DC	LSRD-H2
200/220V AC	LSRD-M2
230/240V AC	LSRD-M4

Dual Pushbuttons

Dual Pushbuttons Part No. Example
Assembled and sub-assembled unit

Assembled (without pilot light)

HW7D - B 1 1 P 10 10 GR 1

- ① Operation code
1: Momentary
2: Interlocking
- ② Button style code
1: Flush-Flush
2: Flush-Extended
- ③ Contact arrangement code (top button)
- ④ Contact arrangement code (bottom button)
- ⑦ Button Legends Code
Blank: Blank
1: I & ON / O & OFF
- ⑥ Button color code
GR: Top Button Green
Bottom Button Red
WB: Top Button White
Bottom Button Black

Top button	Bottom button	Contact configuration	
		Top button	Bottom button
1NO	1NC	10	01
1NO	1NO	10	10
1NO-1NC	1NO-1NC	11	11
2NO	2NC	20	02

Assembled (with pilot light)

HW7D - L 1 1 P 11 20 QH2 PW GR 1

- ① Operation code
1: Momentary
2: Interlocking
- ② Button style code
1: Flush-Flush
2: Flush-Extended
- ③ Contact arrangement code (top button)
- ④ Contact arrangement code (bottom button)
- ⑦ Button Legends Code
Blank: Blank
1: I & ON / O & OFF
- ⑥ Button color code
GR: Top Button Green
Bottom Button Red
WB: Top Button White
Bottom Button Black
- ⑤ Rated voltage code
Q2: 6V AC/DC
Q3: 12V AC/DC
Q4: 24V AC/DC
QH2: 100/120V AC/DC
QM: 200-220V AC
QM4: 220-240V AC

Top button	Bottom button	Contact configuration	
		Top button	Bottom button
1NO	1NC	10	01
1NO	1NO	10	10
1NO-1NC	1NO-1NC	11	11
2NO	2NC	20	02

Operator unit (without pilot light)

HW7D - B 1 1 GR 1

- ① Operation code
1: Momentary
2: Interlocking
- ② Button style code
1: Flush-Flush
2: Flush-Extended
- ⑦ Button Legends Code
Blank: Blank
1: I & ON / O & OFF
- ⑥ Button color code
GR: Top Button Green
Bottom Button Red
WB: Top Button White
Bottom Button Black

Contact unit

HW- CN P 20

- ④ Contact configuration code (see page 752)

Operator unit (with pilot light)

HW7D - L 1 1 PW GR 1

- ① Operation code
1: Momentary
2: Interlocking
- ② Button style code
1: Flush-Flush
2: Flush-Extended
- ⑦ Button Legends Code
Blank: Blank
1: I & ON / O & OFF
- ⑥ Button color code
GR: Top Button Green
Bottom Button Red
WB: Top Button White
Bottom Button Black

Contact unit (for illuminated unit)

HW- CN P 20 Q0

- ④ Contact configuration code (see page 753)

• LED lamps are not supplied.

LED Lamp

LSRD - 6

- ⑤ Rated Voltage code
- 6** : 6V AC/DC **H2** : 100/120V AC/DC
- 1** : 12V AC/DC **M2** : 200/220V AC
- 2** : 24V AC/DC **M4** : 230/240V AC

Dual Pushbuttons Dimensions

All dimensions in mm.

Without Pilot Light

Flush-Flush

1 to 2 contacts

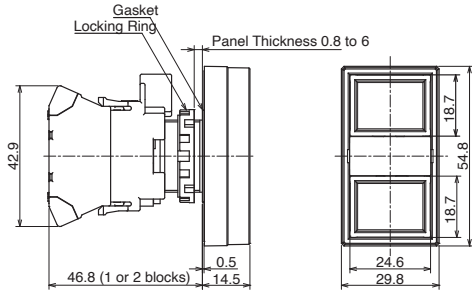

3 to 4 contacts

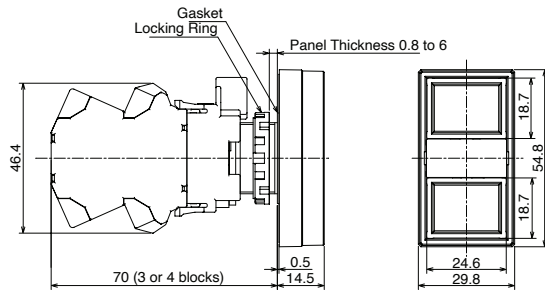

Flush-Extended

1 to 2 contacts

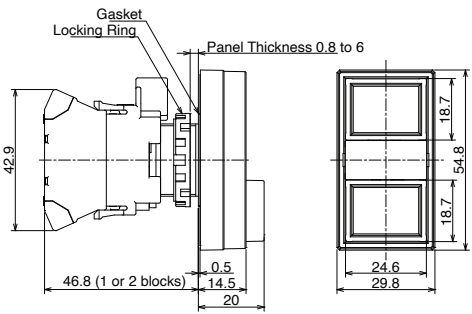

3 to 4 contacts

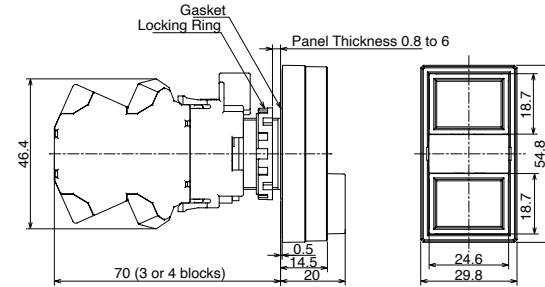

With Pilot Light

Flush-Flush

1 to 2 contacts

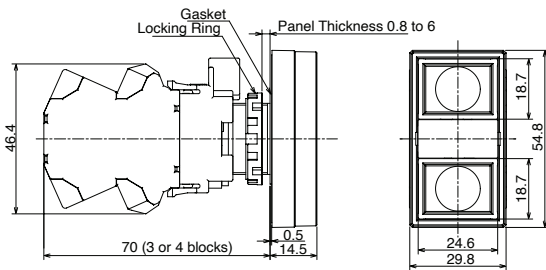

3 to 4 contacts

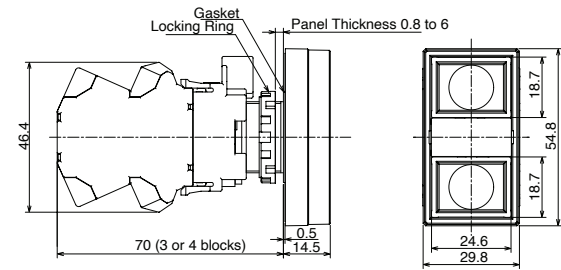

Flush-Extended

1 to 2 contacts

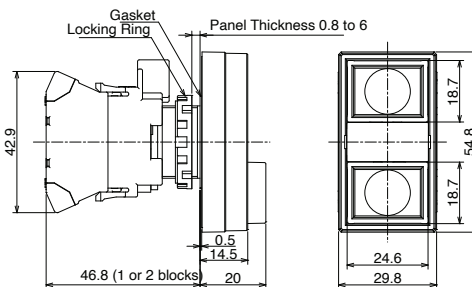

3 to 4 contacts

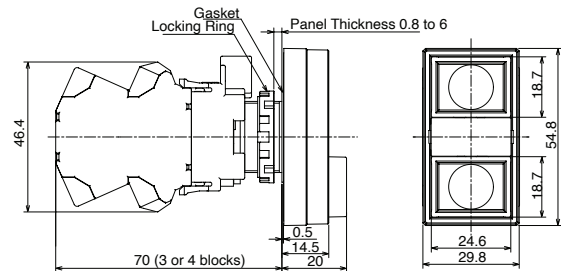

Selector Switches (Knob Operator)

Assembled

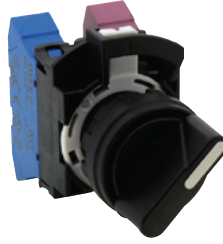

Package Quantity: 1

Shape	No. of Positions	Contact Configuration (Code)	Contact Block		Operator Position			Cam Code	Maintained	1 2		
			Mounting Position	Contact	1	2						
HWⓄS Ⓞ: Bezel Type 1: Black 2: Metal	90° 2-position	1NO (10)	(1)	NO		X		—	—	—	—	
			(3)	—			Dummy					
		1NC (01)	(1)	—			Dummy					
			(3)	NC	X							
		1NO-1NC (11)	(1)	NO			X					
			(3)	NC	X							
	2NO (20)	(1)	NO			X						
		(3)	NO			X						
	2NO-2NC (22)	(1)	NONC	NO			X					
				NC	X							
		(3)	NONC	NO			X					
				NC	X							
45° 3-position	2NO (20)	2NO	(1)	NO	X			—	—	—	Spring return two-way	
			(3)	NO								X
	2NO-1NC (21N1) ★☆	NONC	(1)	NO	X			J	—	—	—	—
			(3)	NO			X					
	2NO-2NC (22)	NONC	(1)	NO	X			—	—	—	—	—
			(3)	NO			X					
	4NO (40)	2NO	(1)	NO	X			—	—	—	—	—
			(3)	NO			X					

- On the contact configuration marked with ★ in the table above, the rated load switching current is reduced to a half of the related current of the contact block. The rated insulation voltage and the rated thermal current remain unchanged.
- On the contact configuration marked with ☆ in the table above, contacts may overlap when the operator position is changed.
- Knob operator: white indicator on black body
- Selector switches with 1 contact block contain 2 dummy blocks. Selector switches with 2 contact blocks contain 1 dummy block.
- Turn the operator to each position accurately.

Contact Block Mounting Position

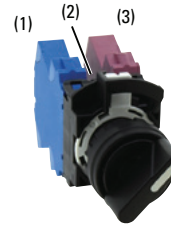

Note) (2) can only be mounted with a dummy block.

For other contact configuration or operator position, select from sub-assembled units (page 757 to 758).

Dimensions

All dimensions in mm.

1 to 2 contacts

3 to 4 contacts

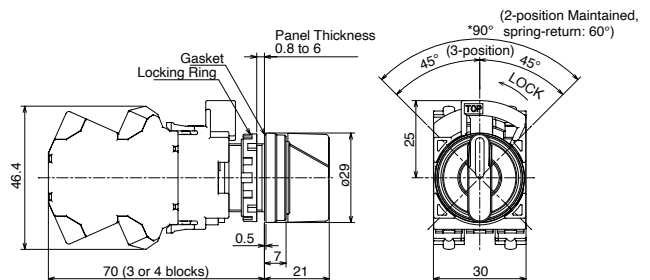
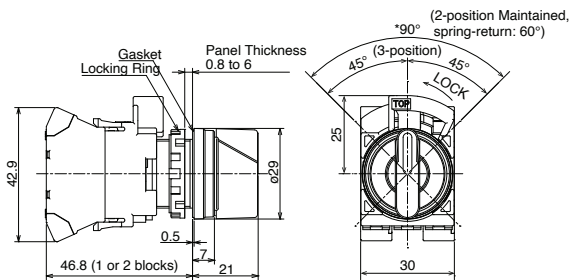

Selector Switches (Knob / Lever Operator) 2-Position















Sub-Assembled

When ordering, specify the sub-assembled ordering no. See page 756 for available assembled products.







90° 2-position

Package Quantity: 1

<Reference> Assembled Part No.						Operator Unit Ordering No.		Contact Unit							
No. of Positions	Contact Configuration (Code)	Contact Block		Operator Position		Cam Code	Operator Position Code Maintained 	Operator type ④	Operator Position Code Maintained (90°) 	Shape	Part No. (Ordering No.)				
		Mounting Position	Contact	1	2							<Reference> Assembled Part No.	Part No. (Ordering No.)		
															
90° 2-position	1NO (10)	(1)	NO		X	-		Knob Operator			HW®S-2④P10	HW-CNP10			
	1NC (01)	(3)	—		Dummy						HW®S-2④P01	HW-CNP01			
	1NO-1NC (11)	(1)	NO		X						HW®S-2④P11	HW-CNP11			
		(3)	NC	X											
	2NO (20)	(1)	NO		X						HW®S-2④P20	HW-CNP20			
		(3)	NO		X										
	2NC (02)	(1)	NC	X							HW®S-2④P02	HW-CNP02			
		(3)	NC	X											
	2NO-2NC (22)	(1)	NO		X						HW®S-2④22	Lever Operator	HW®S-2④		HW-CNP22
		(3)	NC	X											
		(3)	NC	X											
	3NO-1NC (31N1)	(1)	NO		X						HW®S-2④31N1		HW®S-2④		HW-CNP31N1
		(3)	NO		X										
		(3)	NO		X										
	4NO (40)	(1)	NO		X						HW®S-2④40		HW®S-2④		HW-CNP40
		(4)	NO		X										
		(5)	NO		X										
	3NC (03N2)	(1)	NC	X							HW®S-2④03N2		HW®S-2④		HW-CNP03N2
		(3)	NC	X											
		(3)	NC	X											
2NO-1NC (21N1)	(1)	2NO	NO		X	HW®S-2④21N1	HW®S-2④		HW-CNP21N1						
	(3)	NC	NC	X											

90° 2-position Reversed Cam

Package Quantity: 1

<Reference> Assembled Part No.						Operator Unit Ordering No.		Contact Unit					
No. of Positions	Contact Configuration (Code)	Contact Block		Operator Position		Cam Code	Operator position code Maintained 	Shape	Operator position code Maintained (90°) 	Shape	Part No. (Ordering No.)		
		Mounting Position	Contact	2	1							<Reference> Assembled Part No.	Part No. (Ordering No.)
													
90° 2-position	2NC (02)	(1)	NC		X	J	HW®S-2J④TP02	Knob Operator	HW®S-2J④		HW-CNP02		
		(3)	NC		X								

• For part no. other than maintained position, see Part No. Example on page 759.

Note: Turn the operator to each position accurately.

• Specify an operator unit code in place of ④ in the Part No.

• ◎ Bezel Type: 1: Black, 4: Metal

④Operator Unit Code

Code	Operator style	Code	Operator style
T	Knob Operator	L	Lever Operator

For Part No. (Ordering No.)/ mounting positions of contact units, see page 781.

Selector Switches (Knob / Lever Operator) 3-Position

Sub-Assembled

When ordering, specify the sub-assembled ordering no. See page 756 for available assembled products.

Assembled



=

Operator unit



+

Contact unit
(Contact block, dummy block, connecting unit)



45° 3-position

Package Quantity: 1

<Reference> Assembled Part No.							Operator Unit Ordering No.			Contact unit				
No. of Positions	Contact Configuration (Code)	Contact Block		Operator Position			Cam Code	Operator position code Maintained 1 0 2	Operator type ④	Operator position code Maintained 1 0 2	Shape	Part No. (Ordering No.)		
		Mounting Position	Contact	1	0	2							Part No. (Ordering No.)	
45° 3-position	1NO-1NC (11)	(1)	NO	X			—	HW◎S-3④P11	Knob Operator			HW-CNP11		
		(3)	NC	X	X								HW◎S-3④P11N1	HW-CNP11N1
	1NO-1NC (11N1)	(1)	NC		X	X		J		HW◎S-3J④P11N1	Lever Operator			HW-CNP11N1
		(3)	NO			X								
	2NO (20)	(1)	NO	X				J	HW◎S-3J④P21N3	HW◎S-3④				HW-CNP02
		(3)	NO			X								
	2NC (02)	(1)	NC		X	X		J	HW◎S-3J④P21N3		HW◎S-3④			HW-CNP11N1
		(3)	NC	X	X									
	1NO-1NC (11N1) ★☆	(1)	NC		X			J	HW◎S-3J④P21N3	HW◎S-3④				HW-CNP21N3
		(3)	NO			X								
	2NO-1NC (21N3) ★☆	(1)	NONC	NO	X			—	HW◎S-3④P40		HW◎S-3④			HW-CNP22N2
		(3)	NONC	NC		X								
	2NO-2NC (22)	(1)	NONC	NO	X	X		—	HW◎S-3④P04	HW◎S-3④				HW-CNP40
		(3)	NONC	NO		X								
	2NO-2NC (22N2)	(1)	2NC	NO	X	X		—	HW◎S-3④P04		HW◎S-3④			HW-CNP04
		(3)	2NO	NO		X								
4NO (40)	(1)	2NO	NO	X		—	HW◎S-3④P04	HW◎S-3④				HW-CNP04		
	(3)	2NO	NO		X								HW◎S-3④P04	HW-CNP04
4NC (04)	(1)	2NC	NC		X	—	HW◎S-3④P04		HW◎S-3④			HW-CNP04		
	(3)	2NC	NC	X	X								HW◎S-3④P04	HW-CNP04

- On the contact configuration marked with ★ in the table above, the rated load switching current is reduced to a half of the related current of the contact block. The rated insulation voltage and the rated thermal current remain unchanged.
- On the contact configuration marked with ☆ in the table above, contacts may overlap when the operator position is changed.
- For part no. other than maintained position, see Part No. Example on page 759.
- ◎ Bezel Type: 1: Black, 4: Metal
- Specify an operator unit code in place of ④ in the Part No.

④Operator Unit Code

Code	Operator style	Code	Operator style
T	Knob Operator	L	Lever Operator

Note: Turn the operator to each position accurately.

Contact Block Mounting Position

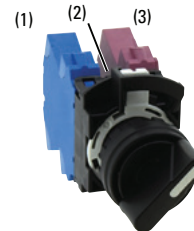

Note) (2) can only be mounted with a dummy block.

For Part No. (Ordering No.)/ mounting positions of contact units, see page 780.

Selector Switches (Knob / Lever Operator)

Selector Switches Part No. Example

Assembled and sub-assembled unit

Assembled (Without Pilot Light)

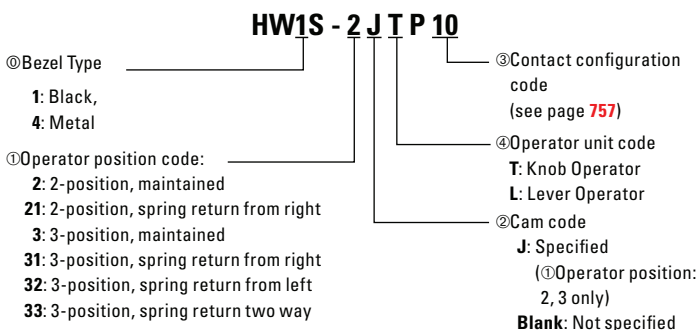

① Operator position code

Maintained (90° 2-position)		Spring Return (60° 2-position)
Cam code: blank	Cam code: J	Cam code: blank

• For available assembled products, see table on page 756.

Operator Truth Tables

2 Position Selector Switches

	Contact	Mounting Position	Operator Position	
			Left	Right
HWⓐS-2T HWⓐK-2* HWⓐF-2	HW-P10 (NO)	1	0	X
		3	0	X
	HW-P01 (NC)	1	X	0
		3	X	0
HW-P10R (NO-EM)	1	0	X	
	3	0	X	

3 Position Selector Switches

	Contact	Mounting Position	Operator Position		
			Left	Center	Right
HWⓐS-3T HWⓐK-3* HWⓐF-3	HW-P10 (NO)	1	X	0	0
		3	0	0	X
	HW-P01 (NC)	1	0	X	X
		3	X	X	0
	HW-P10R (NO-EM)	1	X	0	0
		3	0	0	X

	Contact	Mounting Position	Operator Position		
			Left	Center	Right
HWⓐS-3ST HWⓐK-3S*	HW-P10 (NO)	1	X	0	0
		3	0	0	X
	HW-P01 (NC)	1	0	0	X
		3	X	0	0
	HW-P10R (NO-EM)	1	X	X	0
		3	0	X	X

1. Mounting position indicates which side of operator each contact should be mounted (as viewed from the front of the panel).
2. *For key removable code see page 763

Operator (Without Pilot Light)

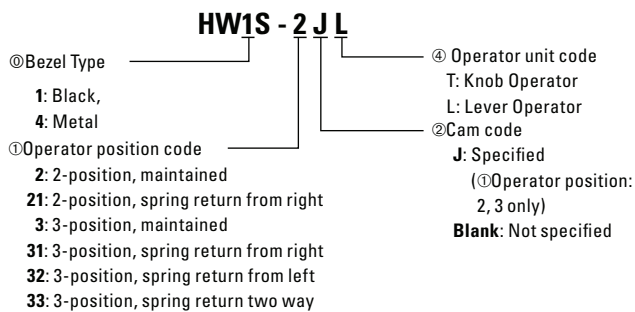

Contact Unit

HW- CN P 10

ⓒ Contact configuration code (see page 757, 758)

Maintained (45° 3-position)	Spring Return (45° 3-position)		
Cam code: Blank, J, or S	Cam code: blank		

3 Position Selector Switches can't

	Contact	Mounting Position	Operator Position		
			Left	Center	Right
HWⓐS-3JT HWⓐK-3J*	HW-P10 (NO)	1	X	0	0
		3	0	0	X
	HW-P01 (NC)	1	0	X	0
		3	0	X	0
	HW-P10R (NO-EM)	1	X	0	X
		3	X	0	X

4 Position Selector Switches

	Contact	Mounting Position	Operator Position			
			1	2	3	4
HWⓐS-4T	HW-P10 (NO)	1	X	0	0	0
		3	0	0	0	X
	HW-P01 (NC)	1	0	0	X	0
		3	0	X	0	0
	HW-P10R (NO-EM)	1	X	X	0	X
		3	X	0	X	X

5 Position Selector Switches

	Contact	Mounting Position	Operator Position				
			1	2	3	4	5
HWⓐS-5T	HW-P10 (NO)	1	X	0	0	0	0
		3	0	0	0	0	X
	HW-P01 (NC)	1	0	0	0	X	0
		3	0	X	0	0	0
	HW-P10R (NO-EM)	1	X	X	X	0	X
		3	X	0	X	X	X

3. HW1S-3T is identified by white plungers on the operator.
4. HW1S-3ST is identified by red plungers on the operator.
5. HW1S-3JT is identified by black plungers on the operator.



Pin tumbler keys can be purchased only as a sub-assembled product.

Key Selector Switches (Disc Tumbler Key)

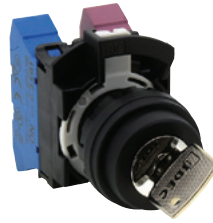
Assembled



Package Quantity: 1

Name / Shape	No. of Positions	Contact Configuration (Code)	Contact Block		Operator Position			Cam Code	Operator position code		
			Mounting Position	Contact	1	2	Maintained (90°)				
Disc Tumbler Key HW1K / HW4K  (NC contact only)	90° 2-position	1NO (10)	(1)	NO		X	—	 Maintained (90°)			
			(3)	—		Dummy					
		1NO-1NC (11)	(1)	NO		X	—	HW®K-2AP11 (Key removable in all positions) HW®K-2BP11 (Key removable at left)			
			(3)	NC	X						
		2NO (20)	(1)	NO		X	—	HW®K-2AP20 (Key removable in all positions) HW®K-2BP20 (Key removable at left)			
			(3)	NO		X					
	2NO-2NC (22)	(1)	NONC	NO	X	—	HW®K-2AP22N2 (Key removable in all positions) HW®K-2BP22N2 (Key removable at left)				
		(3)	NONC	NO	X						
	45° 3-position	2NO (20)	(1)	NO	X			—	HW®K-3AP20 (Key removable in all positions) HW®K-3BP20 (Key removable at left/center) HW®K-3DP20 (Key removable at center)		
				(3)	NO						X
			1NO-1NC (11N1)	(1)	NC		X		J	HW®K-3JBP11N1 (Key removable at left/center) HW®K-3JGP11N1 (Key removable at left)	
				(3)	NO			X			
2NO-2NC (22)			(1)	NONC	NO	X	X	—	HW®K-31BP22 (Key removable at left/center) HW®K-31GP22 (Key removable at left)		
			(3)	NONC	NO	X	X				
2a-2b (22N2)		(1)	2NC	NC	X	X	—	HW®K-31BP22N2 (Key removable at left/center) HW®K-31GP22N2 (Key removable at left)			
		(3)	2NO	NO		X					

- Selector switches with 1 contact block contain 2 dummy blocks. Selector switches with 2 contact blocks contain 1 dummy block.



- Standard key number (231) is available for assembled products. *For numbers other than standard key numbers, contact IDEC.

• For other contact configuration or operator position, select from sub-assembled units (page 761 to 762).

Key removal position





⓪ Bezel Type 1: Black, 4: Metal

① 90° 2-position

Key Retained Position (Cam code: blank)	
A: Key removable in all positions 	B: Key removable at left 

①②: Key removal position ①②: Key retained position

② 45° 3-position

Key Retained Position			
A: Key removable in all positions 	B: Key removable at left / center 	D: Key removable at center 	G: Key removable at left 

⓪①②: Key removal position ①①②: Key retained position

Note: The key cannot be removed in a spring return position.

Contact Block Mounting Position

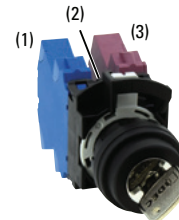

Note) (2) can only be mounted with a dummy block.

Switches & Pilot Devices

Signaling Lights

Relays & Sockets

Timers

Contactors

Terminal Blocks

Circuit Breakers

Pin tumbler keys can be purchased only as a sub-assembled product.

Key Selector Switches (Disc Tumbler Key / Pin Tumbler Key) 2-Position

Sub-Assembled

When ordering, specify the sub-assembled ordering no. See page 760 for available assembled products.



Disc Tumbler

Pin Tumbler

90° 2-position

Package Quantity: 1

No. of Positions	Contact Configuration (Code)	Contact Block		Operator Position		Cam Code	Operator position code		Operator Unit Ordering No.	Contact Unit		
		Mounting Position	Contact	1	2		Maintained	1		2	Shape	Part No. (Ordering No.)
90° 2-position	1NO (10)	(1)	NO		X	-	HW⓪K-2③④P10	Disc Tumbler	HW⓪K-2③④⑥		HW-CNP10	
		(3)	—		Dummy							
	1NC (01)	(1)	—		Dummy			HW⓪K-2③④P01			HW-CNP01	
		(3)	NC	X								
	1NO-1NC (11)	(1)	NO		X			HW⓪K-2③④P11			HW-CNP11	
		(3)	NC	X								
	2NO (20)	(1)	NO		X			HW⓪K-2③④P20			HW-CNP20	
		(3)	NO		X							
	2NC (02)	(1)	NC	X				HW⓪K-2③④P02			HW-CNP02	
		(3)	NC	X								
	2NO-2NC (22)	(1)	NONC	NO			X	HW⓪K-2③④P22			HW-CNP22	
				NC	X							
		(3)	NONC	NO			X					
				NC	X							
	3NO-1NC (31)	(1)	NONC	NO			X	HW⓪K-2③④P31			HW-CNP31	
				NO			X					
		(3)	NONC	NO			X					
				NC	X							
4NO (40)	(1)	2NO	NO		X	HW⓪K-2③④P40		HW-CNP40				
			NO		X							
	(3)	2NO	NO		X							
			NO		X							
3NC (03N2)	(1)	2NC	NC	X		HW⓪K-2③④P03N2		HW-CNP03N2				
			NC	X								
	(3)	NC	NC	X								
			NC	X								
2NO-1NC (21N1)	(1)	2NO	NO		X	HW⓪K-2③④P21N1		HW-CNP21N1				
			NO		X							
	(3)	NC	NC	X								

• For part no. other than maintained position, see Part No. Example on page 763.

• Each selector key switch is supplied with two keys.

• ⓪ Bezel Type 1: Black, 4: Metal

• Specify the key style in ③.

③Key type code

Code	Key Operator Shape
Blank	Disc tumbler
P	Pin tumbler

} See page 763 Part No. Development for details.

• Specify the desired key removal position in ④.

• Specify the key number in ⑥.

For Part No. (Ordering No.)/ mounting positions of contact units, see page 000?.

Pin tumbler keys can be purchased only as a sub-assembled product.

Key Selector Switches (Disc Tumbler Key / Pin Tumbler Key) 3-Position

Sub-Assembled

When ordering, specify the sub-assembled ordering no. See page 760 for available assembled products.

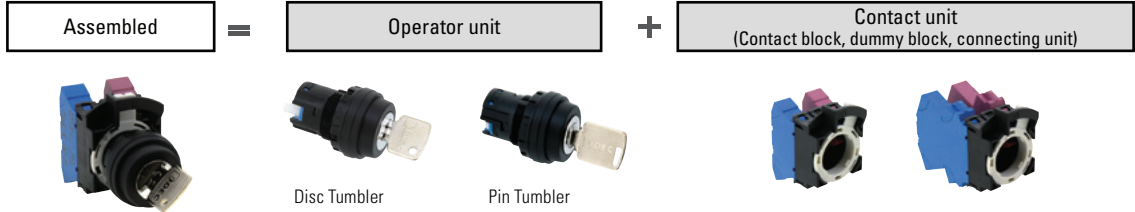

45° 3-position

Package Quantity: 1

No. of Positions	Contact Configuration (Code)	Contact Block		Operator Position			Cam Code	Operator Unit Ordering No.		Contact Unit		
		Mounting Position	Contact	1	0	2		ⓐKey Operator Type	Operator position code Maintained 1 0 2	Shape	Part No. (Ordering No.)	
				ⓑ	ⓓ	ⓔ						
45° 3-position	1NO-1NC (11)	(1)	NO	X			—	Disc Tumbler	HWⓐK-3ⓓⓔP11		HW-CNP11	
		(3)	NC	X	X							
	1NO-1NC (11N1)	(1)	NC		X	X			Pin Tumbler	HWⓐK-3ⓓⓔP11N1		HW-CNP11N1
		(3)	NO					X				
	2NO (20)	(1)	NO	X					HWⓐK-3ⓓⓔP20	HWⓐK-3ⓓⓔⓖ		HHW-CNP20
		(3)	NO					X				
	2NC (02)	(1)	NC		X	X			HWⓐK-3ⓓⓔP02	HWⓐK-3ⓓⓔⓖ		HW-CNP02
		(3)	NC	X	X							
	1NO-1NC (11N1) ★ ☆	(1)	NC		X				J	HWⓐK-3JⓓⓔP11N1		HW-CNP11N1
		(3)	NO			X						
	2NO-1NC (21N3) ★ ☆	(1)	NONC	NO	X				J	HWⓐK-3JⓓⓔP21N3		HW-CNP21N3
		(3)	NO	NC		X						
2NO-2NC (22)	(1)	NONC	NO	X			HWⓐK-3ⓓⓔP22	HWⓐK-3ⓓⓔⓖ		HW-CNP22N1		
	(3)	NONC	NC	X	X							
2NO-2NC (22N2)	(1)	NONC	NC	X	X		HWⓐK-3ⓓⓔP22N2	HWⓐK-3ⓓⓔⓖ		HW-CNP22N2		
	(3)	NONC	NO			X						
4NO (40)	(1)	NONC	NO	X			HWⓐK-3ⓓⓔP40	HWⓐK-3ⓓⓔⓖ		HW-CNP40		
	(3)	NONC	NO			X						
4NC (04)	(1)	NONC	NC	X	X		HWⓐK-3ⓓⓔP04	HWⓐK-3ⓓⓔⓖ		HW-CNP04		
	(3)	NONC	NC	X	X							

- On the contact arrangement marked with ★ in the table above, the rated load switching current is reduced to a half of the related current of the contact block. The rated insulation voltage and the rated thermal current remain unchanged.
- For models with ☆, contacts may overlap when the operator position is changed.
- For part no. other than maintained position, see Part No. Example on page 763.
- Each selector key switch is supplied with two keys.
- ⓐ Bezel Type 1: Black, 4: Metal
- Specify the key style in ⓑ.
- ⓐKey type code

Code	Key Operator Shape
Blank	Disc tumbler
P	Pin tumbler

See page 763 Part No. Development for details.

- Specify the desired key removal position in ⓓ.
- Specify the key number in ⓔ.

Contact Block Mounting Position

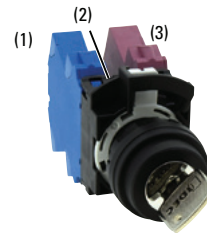

Note) (2) can only be mounted with a dummy block.

For Part No. (Ordering No.)/ mounting positions of contact units, see page 781.

Key Selector Switches (Disc Tumbler Key / Pin Tumbler Key)

Key Selector Switches Part No. Example

Assembled and sub-assembled unit

Assembled Part No. Example

HW1K - 2 J P A P 01 - 501

① Bezel Type
 1: Black,
 4: Metal

② Operator position code:
 2: 2-position, maintained
 21: 2-position, spring return from right
 3: 3-position, maintained
 31: 3-position, spring return from right
 32: 3-position, spring return from left
 33: 3-position, spring return two way

③ Cam code
 J: Specified (① Operator position: 2, 3 only)
 Blank: Not specified

④ Key Style
 Blank: Disc Tumbler Key
 P: Pin Tumbler Key

⑤ Key No.
 Disc Tumbler Key
 Blank: Standard (231)
 Pin Tumbler Key
 Blank: Standard (500)
 -501 to -515 (non-standard)
 *For key numbers other than the standard key number, contact us.

⑥ Contact configuration code

⑦ Key removal position
 2-position
 A: Removable in all positions
 B: Removable in the left only
 C: Removable in the right only

3-position
 A: Removable in all positions
 B: Removable in the left and center
 C: Removable in the right and center
 D: Removable in center only
 E: Removable in right and left
 G: Removable in left only
 H: Removable in right only

Operator unit

HW1K - 2 J P A - 501

① Bezel Type
 1: Black,
 4: Metal

② Operator position code:
 2: 2-position, maintained
 21: 2-position, spring return from right
 3: 3-position, maintained
 31: 3-position, spring return from right
 32: 3-position, spring return from left
 33: 3-position, spring return two way

③ Cam code
 J: Specified (① Operator position: 2, 3 only)
 Blank: Not specified

④ Key Style
 Blank: Disc Tumbler Key
 P: Pin Tumbler Key

⑤ Key No.
 Disc Tumbler Key
 Blank: Standard (231)
 Pin Tumbler Key
 Blank: Standard (500)
 -501 to -515 (non-standard)
 *For key numbers other than the standard key number, contact us.

⑥ Key removal position
 2-position
 A: Removable in all positions
 B: Removable in the left only
 C: Removable in the right only

3-position
 A: Removable in all positions
 B: Removable in the left and center
 C: Removable in the right and center
 D: Removable in center only
 E: Removable in right and left
 G: Removable in left only
 H: Removable in right only

Contact unit

HW- CN P 10

⑤ Contact configuration code
 (see page 761, 762)

① Operator position code

Maintained (90° 2-position)		Spring Return (60° 2-position)
Cam code: blank	Cam code: J	Cam code: blank

Maintained (45° 3-position)	Spring Return (45° 3-position)		
Cam code: Blank, J, or S	Cam code: blank		

• For available assembled products, see table on page 760.

④ Key removal position

90° 2-position / 60° 2-position

Key Retained Position (Cam code: blank)		
A: Key removable in all positions 	B: Key removable at left 	C: Key removable at right

Key Retained Position (Cam code: J)		
A: Key removable in all positions 	B: Key removable at left 	C: Key removable at right

45° 3-position

Key Retained Position			
A: Key removable in all positions 	B: Key removable at left / center 	C: Key removable at center / right 	D: Key removable at center
E: Key removable at right / left 	G: Key removable at left 	H: Key removable at right 	

①②: Key removal position ①②: Key retained position
 Note: The key cannot be removed in a spring return position.

Key Selector Switches (Pin Tumbler Key)

All dimensions in mm.

Dimensions

Disc Tumbler Key

1 to 2 contacts

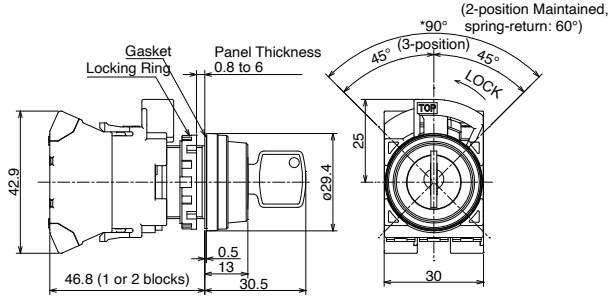

3 to 4 contacts

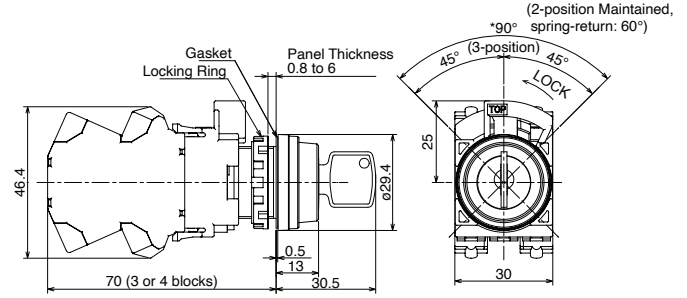

Pin Tumbler Key

1 to 2 contacts

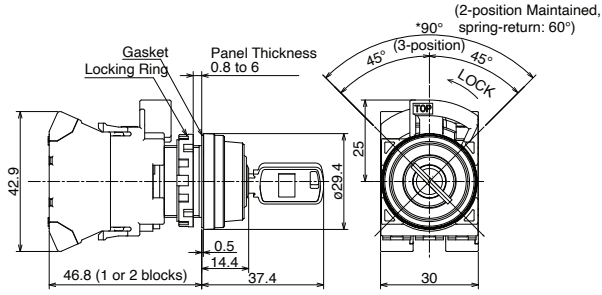

3 to 4 contacts

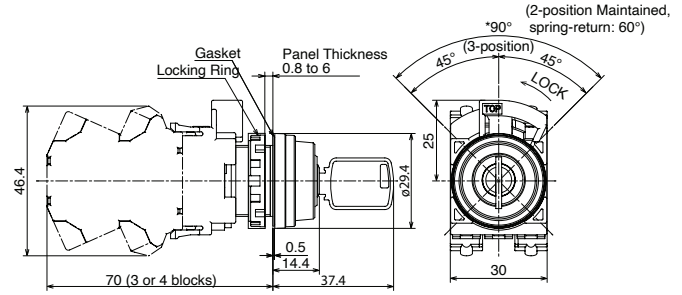

Lever operator can be purchased only as a sub-assembled product.

Illuminated Selector Switches (Knob / Lever Operator) (LED)

Assembled

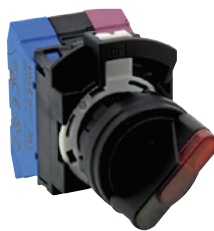

Package Quantity: 1

Name / Shape	No. of Positions	Contact Configuration Table					Operating Voltage	Functional Specifications		Illumination Color Code		
		Contact Configuration	Contact Block		Operator Position			Maintained	—			
			Mounting Position	Contact	1	2		1 2	—			
	90° 2-position	1NO (10)	(1)	NO		X	24V AC/DC	HW®F-2P10Q4®		R (red) G (green) Y (yellow) A (amber) S (blue) PW (pure white)		
			(3)	NO								
		1NO-1NC (11)	(1)	NO		X					HW®F-2P11Q4®	
			(3)	—	X							
		2NO (20)	(1)	NO		X					HW®F-2P20Q4®	
			(3)	NO		X						
		2NO-2NC (22)	(1)	NONC	NO			X				HW®F-2P22Q4®
					NC	X						
			(3)	NONC	NO			X				
					NC	X						
	100/120V AC/DC	1NO (10)	(1)	NO	X		HW®F-2P10QH2®					
			(3)	—	Dummy							
		1NO-1NC (11)	(1)	NO	X			HW®F-2P11QH2®				
			(3)	NC	X							
2NO (20)	(1)	NO		X		HW®F-2P20QH2®						
	(3)	NO		X								
No. of Positions	Contact Configuration	Contact Configuration Table			Operator Position			Operator position code		Illumination Color Code		
		Mounting Position	Contact	1	0	2	Maintained	Spring return two-way				
45° 3-position	2NO (20)	(1)	NO	X			24V AC/DC	HW®F-3P20Q4®		R (red) G (green) Y (yellow) A (amber) S (blue) PW (pure white)		
		(3)	NO			X						

- ® Bezel Type 1: Black, 4: Metal
- Specify an illumination color code in place of ® in the Part No.
- Turn the operator to each position accurately.

• For other contact configuration or operator position, select from sub-assembled units. (page 766 to 767).

Contact Block Mounting Position

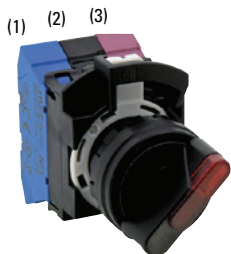

Note) (2) can only be mounted with a full voltage adapter.

Switches & Pilot Devices

Signaling Lights

Relays & Sockets

Timers

Contactors

Terminal Blocks

Circuit Breakers

Illuminated Selector Switches (Knob / Lever Operator) (LED) 2-Position

Sub-Assembled

When ordering, specify the sub-assembled ordering no. See page 765 for available assembled products.

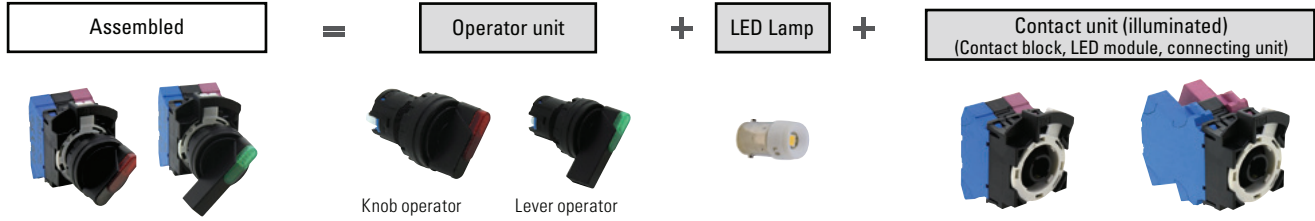

90° 2-position

Package Quantity: 1

<Reference> Assembled Part No					Operator Unit		Contact Unit (Illuminated)						
No. of Positions	Contact Configuration	Contact Block		Operator Position		Cam Code	Operator position code Maintained 1 2	Name / Shape	Operator position code Maintained 1 2	Shape	Part No. (Ordering No.)		
		Mounting Position	Contact	1	2							<Reference> Assembled Part No.	Part No. (Ordering No.)
90° 2-position	1NO (10)	(1)	NO		X	-	HW®F-2®P10®	Knob Operator			HW-CNP10Q0		
		(3)	—		Dummy						HW-CNP01Q0		
	1NC (01)	(1)	—		Dummy		HW®F-2®P01®	Lever Operator				HW-CNP11Q0	
		(3)	NC	X			HW-CNP20Q0						
	1NO-1NC (11)	(1)	NO		X		HW®F-2®P11®					HW-CNP20Q0	
		(3)	NC	X			HW-CNP02Q0						
	2NO (20)	(1)	NO		X		HW®F-2®P20®					HW-CNP22Q0	
		(3)	NO		X		HW®F-2®P02®						
	2NC (02)	(1)	NC	X			HW®F-2®P02®					HW-CNP22Q0	
		(3)	NC	X			HW®F-2®P22®						
	2NO-2NC (22)	(1)	NONC	NO	X			HW®F-2®P22®		HW®F-2®PI-USA			HW-CNP31Q0
		(3)	NONC	NO	X								HW-CNP40Q0
	3NO-1NC (31)	(1)	NONC	NO	X			HW®F-2®P31®					HW-CNP40Q0
		(3)	NONC	NO	X								HW-CNP03N2Q0
	4NO (40)	(1)	2NO	NO	X			HW®F-2®P40®					HW-CNP03N2Q0
		(3)	2NO	NO	X								
	3NC (03N2)	(1)	2NC	NC	X			HW®F-2®P03N2®					
		(3)	NC	NC	X								

• ® Bezel Type 1: Black, 4: Metal

• Specify an operator unit code in place of ® in the Part No.

® Operator Unit Code

Code	Operator style
Blank	Knob Operator
L	Lever Operator

• Specify a rated voltage code in place of ® in the Part No.

Code	Rated voltage	Code	Rated voltage
Q2	6V AC/DC	QH2	100/120V AC/DC
Q3	12V AC/DC	QM	200/220V AC
Q4	24V AC/DC	QM4	230/240V AC

• Specify an illumination color code in place of ® in the Part No.
R (red), G (green), Y (yellow), A (amber), S (blue), PW (pure white)

• For part no. other than maintained position, see Part No. Example on page 768.

Note) LED lamp is not supplied. When ordering contact units (illuminated) selected LED from below table.

LED lamp (package quantity:1)	
Rated Voltage	Part No. (Ordering No.)
6V AC/DC	LSRD-6
12V AC/DC	LSRD-1
24V AC/DC	LSRD-2
100/120V AC/DC	LSRD-H2
200/220V AC	LSRD-M2
230/240V AC	LSRD-M4

For Part No. (Ordering No.)/ mounting positions of contact units, see page 781.

Illuminated Selector Switches (Knob / Lever Operator) (LED) 3-Position

Sub-Assembled

When ordering, specify the sub-assembled ordering no. See page 765 for available assembled products.

45° 3-position

Package Quantity: 1

No. of Positions	Contact Configuration	Contact Block		Operator Position			<Reference> Assembled Part No.		Operator Unit		Contact Unit (Illuminated)	
		Mounting Position	Contact	1	0	2	Maintained	Name / Shape	Maintained	Shape	Part No. (Ordering No.)	
							Operator position code		Operator position code			
45° 3-position	1NO-1NC (11)	(1)	NO	X				HWⓄF-3ⓄP11ⓄⓈ	Knob Operator	HWⓄF-3ⓄⓈ-PI-USA		HW-CNP1100
		(3)	NC	X	X							
	1NO-1NC (11N1)	(1)	NC			X	X	HWⓄF-3ⓄP11N1ⓄⓈ	Lever Operator			HW-CNP11N100
		(3)	NO				X					
	2NO (20)	(1)	NO	X				HWⓄF-3ⓄP20ⓄⓈ				HW-CNP0200
		(3)	NO									X
	2NC (02)	(1)	NC		X	X		HWⓄF-3ⓄP02ⓄⓈ				HW-CNP0200
		(3)	NC	X	X							
	1NO-1NC (11N1) ★☆☆	(1)	NC				X	HWⓄF-3JⓄP11N1ⓄⓈ				HW-CNP11N100
		(3)	NO									X
	2NO-1NC (21N3) ★☆☆	(1)	NONC	NO	X			HWⓄF-3JⓄP21N3ⓄⓈ				HW-CNP30N100
		(3)	NO				X					
	2NO-2NC (22)	(1)	NONC	NO	X			HWⓄF-3ⓄP22ⓄⓈ				HW-CNP22N100
		(3)	NONC	NO			X					
	2NO-2NC (22N2)	(1)	2NC	NO		X	X	HWⓄF-3ⓄP22N2ⓄⓈ				HW-CNP22N200
		(3)	2NO	NO			X					
	4NO (40)	(1)	2NO	NO	X			HWⓄF-3ⓄP40ⓄⓈ				HW-CNP4000
		(3)	2NO	NO			X					
4NC (04)	(1)	2NC	NC		X	X	HWⓄF-3ⓄP04ⓄⓈ			HW-CNP0400		
	(3)	2NC	NC	X	X							HW-CNP0400

• Ⓞ Bezel Type 1: Black, 4: Metal

• Specify an operator unit code in place of Ⓞ in the Part No.

Ⓞ Operator Unit Code

Code	Operator style
Blank	Knob Operator
L	Lever Operator

• Specify a rated voltage code in place of Ⓞ in the Part No.

Code	Rated voltage	Code	Rated voltage
Q2	6V AC/DC	QH2	100/120V AC/DC
Q3	12V AC/DC	QM	200/220V AC
Q4	24V AC/DC	QM4	230/240V AC

• Specify an illumination color code in place of Ⓞ in the Part No.

R (red), G (green), Y (yellow), A (amber), S (blue), PW (pure white)

Contact Block Mounting Position

(1) (2) (3)

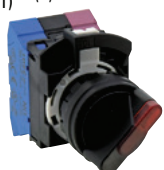

Note) (2) can only be mounted with a LED module.

• For part no. other than maintained position, see Part No. Example on page 768.

Note) LED lamp is not supplied. When ordering contact units (illuminated) selected LED from below table.

LED lamp (package quantity:1)	
Rated Voltage	Part No. (Ordering No.)
6V AC/DC	LSRD-6
12V AC/DC	LSRD-1
24V AC/DC	LSRD-2
100/120V AC/DC	LSRD-H2
200/220V AC	LSRD-M2
230/240V AC	LSRD-M4

Illuminated Selector Switches (Knob / Lever Operator) (LED)

All dimensions in mm.

Dimensions

Knob Operator

1 to 2 contacts

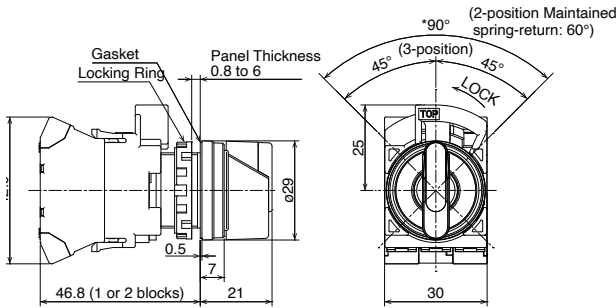

3 to 4 contacts

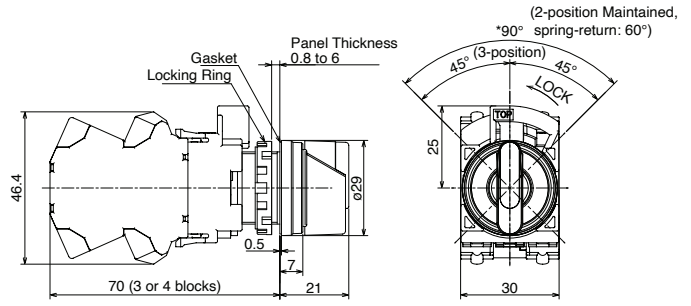

Lever Operator

1 to 2 contacts

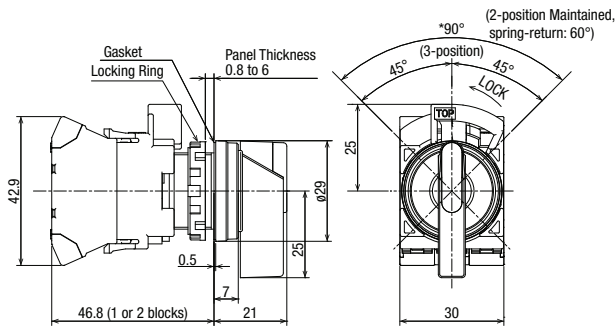

3 to 4 contacts

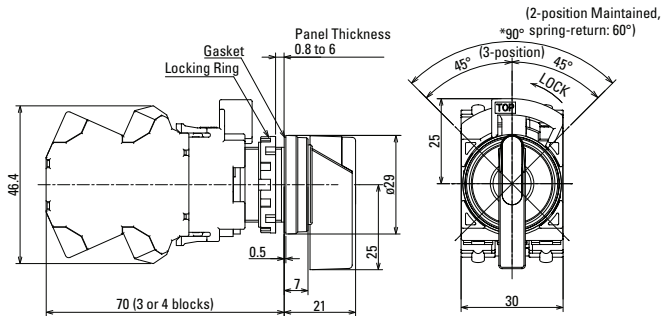

Illuminated Selector Switches Part No. Example

Assembled and sub-assembled unit

Assembled Part No. Example

HW1F - 2 J L P 11 Q4 R

- Ⓐ Bezel Type
 - 1: Black,
 - 4: Metal
- Ⓛ Operator position code:
 - 2: 2-position, maintained
 - 21: 2-position, spring return from right
 - 3: 3-position, maintained
 - 31: 3-position, spring return from right
 - 32: 3-position, spring return from left
 - 33: 3-position, spring return two way
- Ⓒ Cam code
 - J: Specified
 - (Ⓛ Operator position: 2, 3 only)
 - Blank: Not specified
- Ⓜ Operator unit code
 - Blank: Knob Operator
 - L: Lever Operator
- Ⓝ Illuminated color code (see page 765)
- Ⓟ Operating voltage
 - Q2 : 6V AC/DC
 - Q3 : 12V AC/DC
 - Q4 : 24V AC/DC
 - QH2 : 100/120V AC/DC
 - QM : 200/220V AC
 - QM4 : 200/240V AC
- Ⓠ Contact configuration code (see page 767)

• For available assembled products, see table on page 765.

Operator unit

HW1F - 2 L R - PI-USA

- Ⓐ Bezel Type
 - 1: Black,
 - 4: Metal
- Ⓛ Operator position code
 - 2: 2-position, maintained
 - 21: 2-position, spring return from right
 - 3: 3-position, maintained
 - 31: 3-position, spring return from right
 - 32: 3-position, spring return from left
 - 33: 3-position, spring return two way
- Ⓝ Illuminated color code (see page 765)
- Ⓞ Operator unit code
 - T: Knob Operator
 - L: Lever Operator

Contact Unit (for illuminated unit)

HW- CN P 20 Q0

- Ⓠ Contact configuration code (see page 766, 767)

Note) LED lamps are not supplied.

LED Lamp

LSRD - 6

- Ⓝ Rated voltage code
 - 6: 6V AC/DC
 - 1: 12V AC/DC
 - 2: 24V AC/DC
 - H2: 100/120V AC/DC
 - M2: 200/220V AC
 - M4: 230/240V AC

Selector Pushbuttons

Assembled



Package Quantity: 1

Name / Shape	Circuit Code.	Contact Configuration	Contact Block		Left		Right		Ring Operator	③ Button Color Code
			Mounting Position	Contact	Normal	Push	Normal	Push		
HW1R 	D	2NO (20)	(1)	NO		X			HW1R-2DP20③	B (black) G (green)
			(3)	NO				X		

- Specify a button color code in place of ③ in the part No.
- When operating the pushbutton selector, do not turn the operator ring or the lock lever while the button is depressed. Otherwise the pushbutton selector may be damaged.

• For other circuit codes, select from sub-assembled units (page 770).

Contact Block Mounting Position

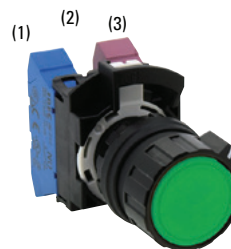

Note) (2) can only be mounted with a dummy block.

Dimensions

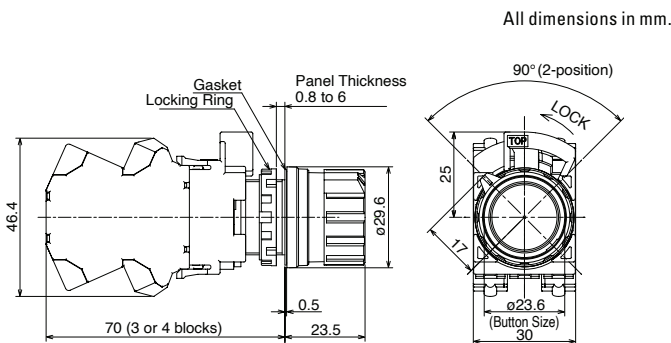
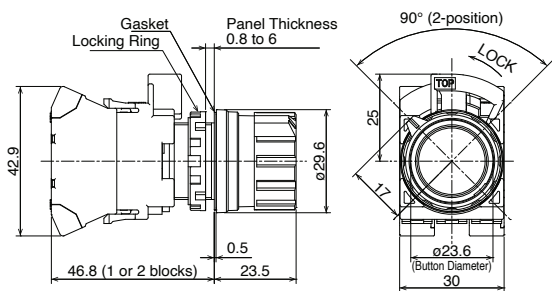

All dimensions in mm.

Selector Pushbuttons Part No. Example

Assembled and sub-assembled unit

Assembled Part No. Example

HW1R - 2 D P 20 B

① Circuit code (see page 770) ———— ③ Button color code (see page 770)

② Contact configuration code

- 11: 1NO1NC
- 20: 2NO
- 22: 2NO-2NC
- 11N1: 1NO-1NC
- 22N2: 2NO-2NC

• For available assembled products, see table on page 770.

Operator unit

HW1R - 2 A B

① Circuit code (see page 770) ———— ③ Button color code (see page 770)

Contact unit

HW - CN P 10

② Contact configuration code (see page 770)

Selector Pushbuttons

Sub-Assembled

When ordering, specify the sub-assembled ordering no. See page 769 for available assembled products.



Sub-Assembled

Ordering No.

Package Quantity: 1

Circuit Code	Contact Configuration (Code)	Contact Block		Left		Right		Ring Operator	③ Button Color Code	
		Mounting Position	Contact	Normal	Push	Normal	Push	Part No. (Ordering No.)		
A	1NO-1NC (11)	(1)	NO		X		X	HW1R-2AP11③	B (black) G (green) R (red) Y (yellow) S (blue) W (white)	
		(3)	NC	X						
	2NO (20)	(1)	NO		X		X			HW1R-2AP20③
		(3)	NO		X	X	X			
	2NO-2NC (22)	(1)	2NO	NO		X				HW1R-2AP22N1③
				NO		X				
(3)		2NC	NC	X						
			NC	X						
D	2NO (20)	(1)	NO		X		HW1R-2DP20③			
			NO			X				
	2NO-2NC (22)	(1)	NONC	NO		X	HW1R-2DP22③			
			NONC	NC	X	X		X		
E	2NO-2NC (22)★	(1)	NONC	NO		X	HW1R-2EP22③			
			NONC	NC		X		X		
	(3)	NONC	NO		X					
			NC	X	X					
F	2NO-2NC (22)★☆	(1)	NONC	NO			HW1R-2FP22③			
			NONC	NC		X				
	(3)	NONC	NO		X					
			NC	X						
N	2NO-2NC (22N2)★☆	(1)	2NC	NC		X	HW1R-2NP22N2③			
			2NC	NC		X				
	(3)	2NO	NO		X	X				
			NO		X	X				
T	2NO-2NC (22)	(1)	NONC	NO		X	HW1R-2TP22③			
			NONC	NC	X					
	(3)	NONC	NO		X	X				
			NC	X						

Operator unit Part No. (Ordering No.)	Contact Configuration (Code)	Contact unit Part No. (Ordering No.)
HW1R-2A③	1NO-1NC (11)	HW-CNP11
	2NO (20)	HW-CNP20
	2NO-2NC (22N1)	HW-CNP22N1
HW1R-2D③	2NO (20)	HW-CNP20
	2NO-2NC (22)	HW-CNP22
HW1R-2E③	2NO-2NC (22)	HW-CNP22
HW1R-2F③	2NO-2NC (22)	HW-CNP22
HW1R-2N③	2NO-2NC (22N2)	HW-CNP22N2
HW1R-2T③	2NO-2NC (22)	HW-CNP22

- On the contact arrangement marked with ★ in the table above, the rated load switching current is reduced to a half of the related current of the contact block. The rated insulation voltage and the rated thermal current remain unchanged.
- For models with ☆, contacts may overlap when the operator position is changed.
- When operating the pushbutton selector, do not turn the operator ring or the lock lever while the button is depressed. Otherwise the pushbutton selector may be damaged.
- For contact mounting position, see page 781.

For Part No. (Ordering No.)/ mounting positions of contact units, see page 781.

Momolever switches can be purchased only as a sub-assembled product.

Monolever Switches

Sub-Assembled

When ordering, specify the sub-assembled ordering no.

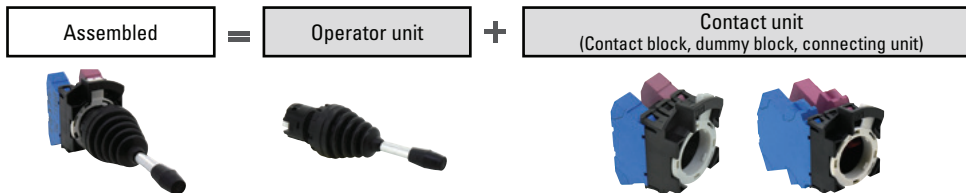



Sub-Assembled Ordering No.

Package Quantity: 1

Name / Shape	Positions	<Reference> Assembled Part No.
HW1M Standard 	2-position	HW1M-P1010-20
		HW1M-P2020-20
		HW1M-P0101-20
		HW1M-P0202-20
	4-position	HW1M-P0101-40
		HW1M-P0202-40
		HW1M-P1111-22N9
		HW1M-P2222-22N9
HW1M-L Interlocking 	2-position	HW1M-LP1010-20
		HW1M-LP2020-20
		HW1M-LP0101-20
		HW1M-LP0202-20
	4-position	HW1M-LP0101-40
		HW1M-LP0202-40
		HW1M-LP1111-22N9
		HW1M-LP2222-22N9

Operator unit	
Name / Shape	Part No. (Ordering No.)
HW1M Standard 	HW1M-1010
	HW1M-2020
	HW1M-0101
	HW1M-0202
	HW1M-0101
	HW1M-0202
HW1M-L Interlocking 	HW1M-L1010
	HW1M-L2020
	HW1M-L0101
	HW1M-L0202
	HW1M-L0101
	HW1M-L0202

Contact unit		
Shape	Contact Configuration	Part No. (Ordering No.)
	2NO (20)	HW-CNP20
	4NO (40)	HW-CNP40
	2NO-2NC (22)	HW-CNP22
	2NO (20)	HW-CNP20
	4NO (40)	HW-CNP40
	2NO-2NC (22)	HW-CNP22

• On all mono-lever switches, the rated current (load switching current) is reduced to a half of the rated current of the contact block. The rated insulation voltage and the rated thermal current remain unchanged.

• For contact mounting position, see page 781.

For Part No. (Ordering No.)/ mounting positions of contact units, see page 781.

Monolever Switches

Contact Configuration

2-position (Right/Left)

Contact Code	Contact Block		Lever Operator Position			
	Mounting Position	Contact	Left	Center	Right	
20	(1)	NO	X			
	(3)	NO			X	
40	(1)	2NO	NO	X		
			NO	X		
	(3)	2NO	NO			X
			NO			X

2-position (Up/Down)

Contact Code	Contact Block		Lever Operator Position			
	Mounting Position	Contact	Down	Center	Up	
20	(1)	NO	X			
	(3)	NO			X	
20	(1)	2NO	NO	X		
			NO	X		
	(3)	2NO	NO			X
			NO			X

Contact Code	Contact Block		Lever Operator Position				
	Mounting Position	Contact	Down	Left	Center	Up	Right
22	(1)	NONC	NO		X		
			NC				X
22	(3)	NONC	NO				X
			NC	X			

Contact Block Mounting Position

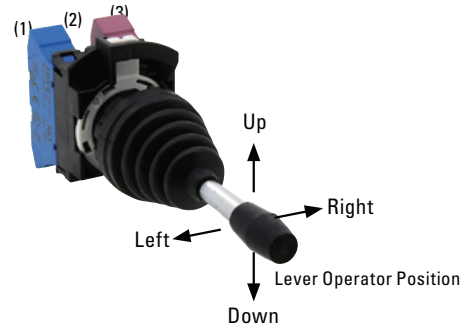

Note) (2) can only be mounted with a dummy block.
 Note) The lever operator of the interlocking type HW1M-L is locked only in the center position. Pull on the interlocking lever before operating the lever up/down/right/left.

Monolever Switches Part No. Example

Assembled and sub-assembled unit

Assembled Part No. Example

HW1M-L P 1 0 1 0 - 20

- ①Model **HW1M**: Standard
HW1M-L: Interlocking
- ②Lever operation mode
Order of Entry
Up - Right - Down - Left
1: Maintained
2: Spring returned
0: Blocked
- ③Contact configuration code
Select a required contact operation at each lever operator position from the contact arrangement charts above and specify the Contact Code.

• For available assembled products, see table on page 771.

Operator unit

HW1M - L 1 0 1 0

- ①Model **HW1M**: Standard
HW1M-L: Interlocking
- ②Lever operation mode
Order of Entry
Up - Right - Down - Left
1: Maintained
2: Spring returned
0: Blocked

Contact unit

HW- CN P 10 20

- ③Contact configuration code
Select a required contact operation at each lever operator position from the contact arrangement charts above and specify the Contact Code.

Dimensions

Standard

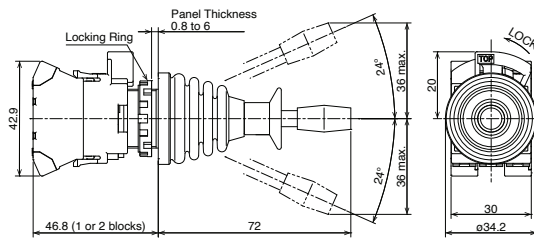
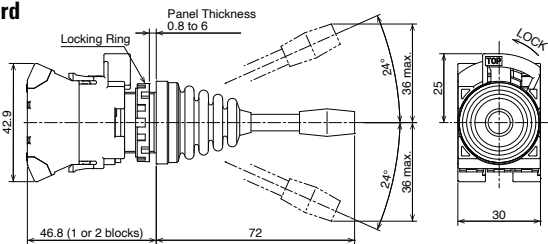

Interlocking

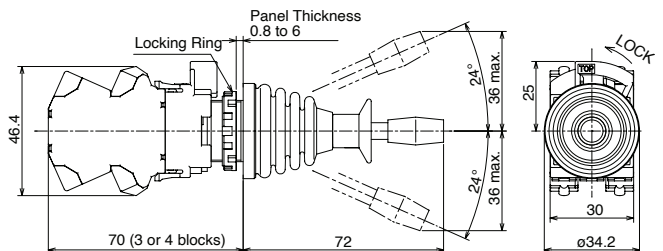
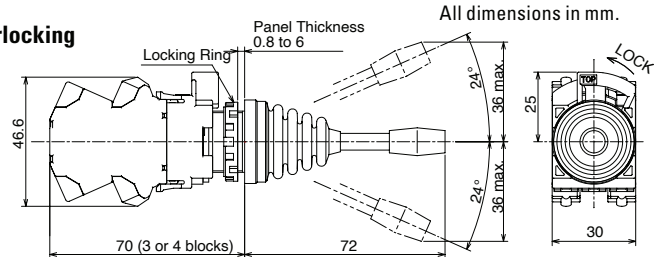



All dimensions in mm.

Short Body Pilot Lights

Assembled



Package Quantity: 1

Name / Shape	Operating Voltage	Part No. (Ordering No.)	① Lens Color Code
Extended (Dome) HW1P 	6V AC/DC	HW1P-2JPQ2 ①	R (red) G (green) Y (yellow) A (amber) S (blue) PW (Pure white)
	12V AC/DC	HW1P-2JPQ3 ①	
	24V AC/DC	HW1P-2JPQ4 ①	
	100/120V AC/DC	HW1P-2JPRH2 ①	
	200/240V AC/DC	HW1P-2JPCM2 ①	
Square Flush HW2P 	6V AC/DC	HW2P-1JPQ2 ①	R (red) G (green) Y (yellow) A (amber) S (blue) PW (Pure white)
	12V AC/DC	HW2P-1JPQ3 ①	
	24V AC/DC	HW2P-1JPQ4 ①	
	100/120V AC/DC	HW2P-1JPRH2 ①	
	200/240V AC/DC	HW2P-1JPCM2 ①	

- Built-in BA9S base LED lamp. See page 787 for LED Lamps.
- For square flush pilot lights, legends and symbols can be engraved on marking plates, or printed film can be inserted. For details on marking plates or film, see page 792. Engraving and films must be prepared by the customer.
- Specify a lens color code in place of ① in the Part No.

Short Body Pilot Lights

Dimensions

All dimensions in mm.

Extended (Dome)
6V, 12V, 24V AC/DC

100/120V AC/DC, 200/240V AC

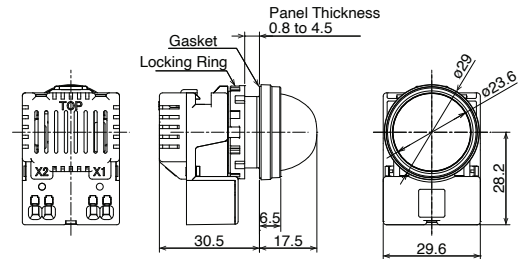
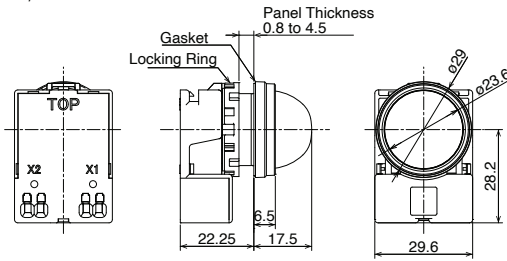

Square Flush
6V, 12V, 24V AC/DC

100/120V AC/DC, 200/240V AC

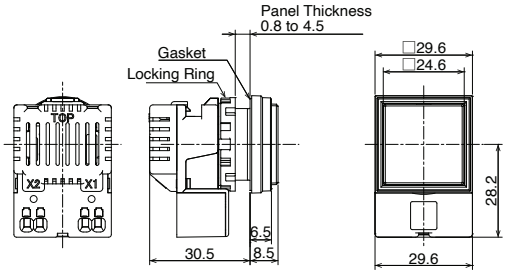
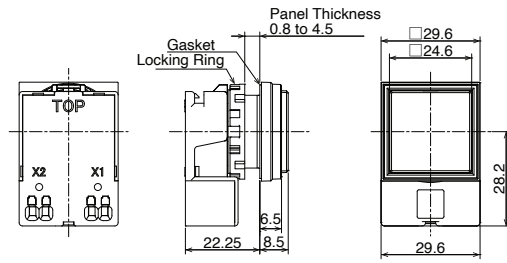



Illuminated / Non-Illuminated Buzzers

Easy installation of buzzers and lamps

- Short, 19.7 mm depth behind panel.
- Buzzer and lamp functions are integrated. (Illuminated buzzers)
- IP65 waterproof from the front of the panel
- Installing an optional terminal rubber boot upgrades the terminal's waterproof characteristics to IP54 without the need to use a rear enclosure.

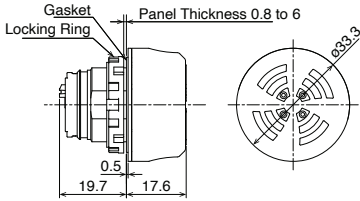

- See website for details on approvals and standards.

Name / Shape	Part No. (Ordering No.)	Illumination Color	Sound Type	Package Quantity	Dimensions (All dimensions in mm.)
	HW1Z-P1F2PQ4R	Red	Intermittent	1	
	HW1Z-P1F2PQ4Y	Yellow			
	HW1Z-2PQ4B	—	Steady	1	
	HW1Z-F2PQ4B	—	Intermittent		

- See page 784 for details on terminal rubber boot.

Specifications and Ratings

Rated Insulation Voltage	30V	
Rated Voltage	12 to 24V DC	
Voltage Range	10.8 to 26.4V DC	
Rated Current (effective value)	Illuminated: 18mA (24V DC), 8mA (12V DC) Non-Illuminated (Steady sound): 9mA (24V DC), 4mA (12V DC) (Intermittent sound): 7mA (24V DC), 3mA (12V DC)	
Inrush Current	100mA maximum	
Buzzer	Sound Pressure (of HW1Z itself) (at 25°C)	90dB min. at 0.1m (24VDC) 70dB min. at 1m (24V DC, equivalent value) 84dB min. at 0.1m (12V DC) 64dB min. at 1m (12VDC, equivalent value)
	Sound Frequency (at 25°C)	2,200 to 2,450Hz
	Sound Type	Illuminated: Intermittent Non-Illuminated: Steady/Intermittent
	Intermittent Cycle (at 25°C)	105 cycles/minute approx. (1.75Hz approx.)
Illumination	Illumination Type	Flashing
	Flash Cycle (at 25°C)	105 cycles/minute approx. (1.75Hz approx.)
Operating Temperature	-20 to +50°C (no freezing)	
Operating Humidity	20 to 85% RH (no condensation)	
Storage Temperature	-30 to +80°C (no freezing)	
Insulation Resistance	100 MΩ minimum (500V DC megger)	
Dielectric Strength	Between live and earthed metal parts: 1000 AC, 1 minute	
Vibration Resistance	Damage limits: 5 to 55Hz, amplitude 0.5 mm Operating extremes: 5 to 55Hz, amplitude 0.5 mm	
Shock Resistance	Operating extremes: 100 m/s ² Damage limits: 1,000 m/s ²	
Degree of Protection	Panel front	IP65 (IEC60529)
	Terminal	IP40 (IEC 60529) IP54 (with terminal rubber boot) (IEC 60529)
Terminal Style	Push-in terminal	
Applicable Wire	Solid wire/ferrule (without insulation cover): 0.2 to 1.5 mm ² , AWG24-16 Ferrule (with insulation cover): 0.2 to 0.75 mm ² , AWG24-18	
Weight (approx.)	17g	

Dimensions

All dimensions in mm.

With terminal rubber boot

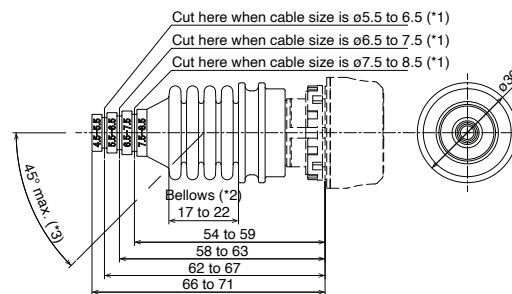

- *1: $\phi 4.5$ - 5.5 cable needs no cutting.
- *2: The bellows must be 17 to 22mm long after installing the terminal rubber boot.
- *3: Maintain a cable angle of 45° max. to the HW1Z axis.

Terminal Arrangement

(bottom view)

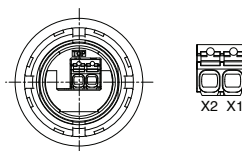

X1 and X2 have no polarity.

Mounting Hole Layout

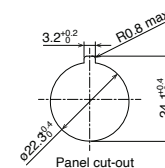

3.2×3.2 hole is for anti-rotation.
Not required when nameplate/anti-rotation is not used.

Instructions for Illuminated / Non-illuminated buzzers: see page 795

Emergency Stop Switches

Emergency Stop Switches

- Direct opening action (IEC 60947-5-5; 5.2, IEC 60947-5-1; Annex K)
- Safety lock mechanism (IEC 60947-5-5; 6.2)
- Degree of Protection IP65 (IEC 60529)



• See website for details on approvals and standards.

Specifications

Operating Temperature		-25 to +60°C (no freezing)
Operating Humidity		45 to 85% RH (no condensation)
Storage Temperature		-40 to +80°C (no freezing)
Minimum Force Required for Direct Opening Action		80N
Minimum Operator Stroke Required for Direct Opening Action		5.5mm
Maximum Operator Stroke		10.0mm
Contact Resistance		50 mΩ maximum (initial value)
Insulation Resistance		100 MΩ minimum (500V DC megger)
Dielectric Strength		Between live and dead parts: 2500V AC, 1 minute Between terminals of different poles: 2500V AC, 1 minute Between terminals of the same poles: 2500V AC, 1 minute
Vibration Resistance	Damage limits	10 to 500 Hz, Amplitude 0.35 mm, Acceleration 50m/s ²
	Operating extremes	10 to 500 Hz, Amplitude 0.35 mm, Acceleration 50m/s ²
Shock Resistance		Damage limits: 1,000 m/s ² Operating extremes: 150 m/s ²
Operation Frequency		900 operations/hour
Life	Mechanical	Single contact block: 100,000 operations minimum Double contact block: 50,000 operations minimum
	Electrical	Single contact block: 100,000 operations minimum Double contact block: 50,000 operations minimum (at 900 operations/h, duty ratio 40%)
Degree of Protection		IP65 (IEC 60529), UL Type 4X
Short-circuit Protection		250V/10A fuse (Type aM IEC 60269-1/IEC 60269-2)
Weight (approx.)		51g (HW1B-V4P02) 67g (HW1B-V4P04) 48g (HW1B-Y2P02)

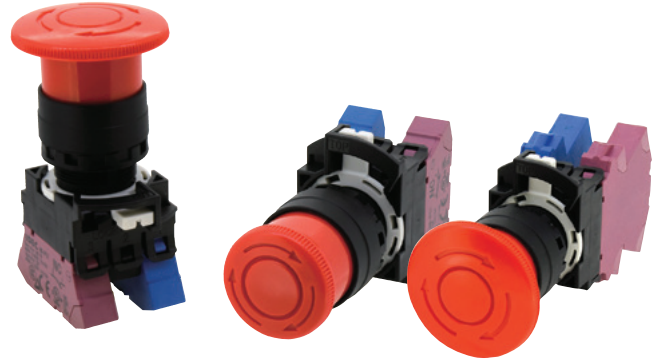

Mounting Hole Layout

All dimensions in mm.

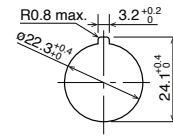

Minimum Mounting Centers for HW1B (emergency stop switch)

	Vertical Spacing	Horizontal Spacing
HW1B-V3 HW1B-V4 HW1B-Y2	50 mm minimum	50 mm minimum
HW1B-V5	60 mm minimum	60 mm minimum

• The minimum mounting centers of HW1B (pushbuttons) and each HW series emergency stop switches are shown. For other button shapes, refer to the dimensions and take wiring and operation of switches into consideration.

Nameplate (for ø22 mm Emergency Stop Switches)

Package Quantity: 1

Shape	Legend	Part No.	Ordering No.	Remarks
	(blank)	HWAV-0-Y	HWAV-0-Y	HWAV-27-Y Nameplate color: yellow Legend color: black Panel thickness: 0.8 to 4.5 mm Material: Polyamide
	EMERGENCY STOP	HWAV-27-Y	HWAV-27-Y	Note) Cannot be used on ø60 mushroom pushlock turn reset switches. Use a nameplate exclusive for ø60 mushroom e-stop. See XW series catalog.

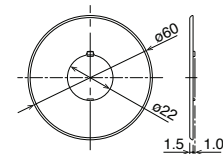

• "EMERGENCY OFF" and white (blank) nameplates available. See website or catalog for SEMI Emergency off (EMO) switches and Stop switches.

Note) For machinery subject to ISO/IEC standards such as machine tools and food machinery, in compliant with the revised ISO13850, it is not recommended to display texts or symbols such as EMERGENCY STOP on the actuator or nameplate of an emergency stop device.

Emergency Stop Switches

Assembled



Package Quantity: 1

Name / Shape	Contact Configuration	Part No. (Coded)
 ø29mm Mushroom Pushlock Turn Reset HW®B-V3	1NC	HW®B-V3P01R
	1NO-1NC	HW®B-V3P11R
	2NC	HW®B-V3P02R
	3NC	HW®B-V3P03N2R
	1NO-1NC	HW®B-V3P22R
	4NC	HW®B-V3P04R

Package Quantity: 1

Name / Shape	Contact Configuration	Part No. (Coded)
 ø40mm Mushroom Pushlock Turn Reset HW1B-V4 HW4B-V4	1NC	HW®B-V4P01R
	1NO-1NC	HW®B-V4P11R
	2NC	HW®B-V4P02R
	3NC	HW®B-V4P03N2R
	1NO-1NC	HW®B-V4P22R
	4NC	HW®B-V4P04R

- Pushlock turn reset – Button is maintained when pressed and is reset when turned clockwise.
- Emergency stop switches with 1 contact block contain 2 dummy blocks. Pushbuttons with 2 contact block contains 1 dummy block.

• For other specifications, select from sub-assembled units (page 778).

Part No. Example

Assembled and sub-assembled unit

Assembled Part No. Example

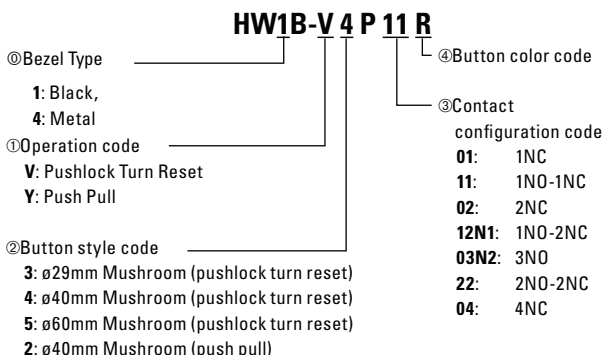

• For available assembled products, see table above.

Note

- For emergency stop purposes, these switches must contain at least one NC contact block.

Sub-assembled operator unit

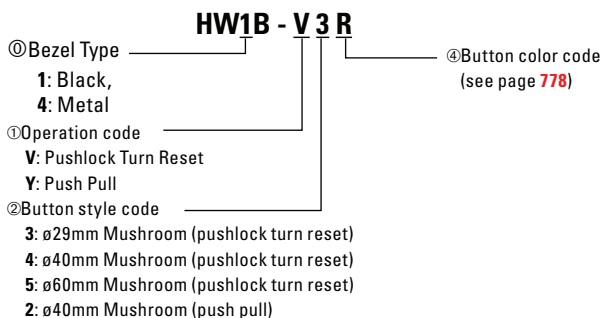

Sub-assembled contact unit

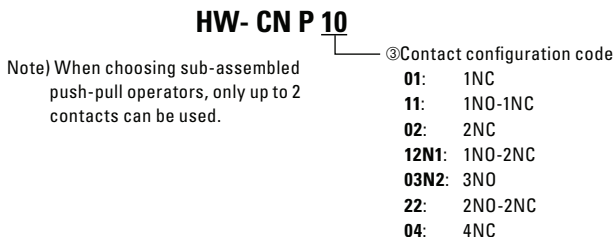



Emergency Stop Switches

Sub-Assembled

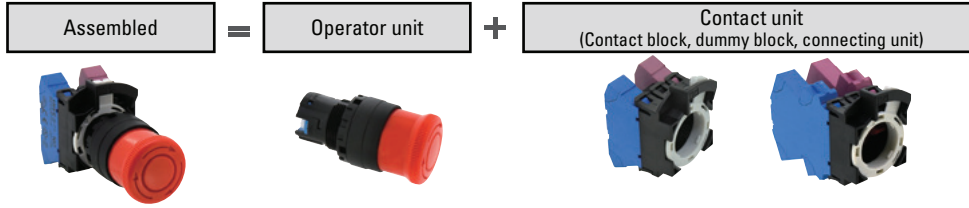
When ordering, specify the sub-assembled ordering no.



Pushlock Turn Reset

Name / Shape	Contact Configuration	<Reference> Assembled Part No. ◎ = 1 or 4	④ Button Color Code
 ø29mm Mushroom HW@B-V3	1NC	HW◎B-V3P01④	R (red) Y (yellow)
	1NO-1NC	HW◎B-V3P11④	
	2NC	HW◎B-V3P02④	
	1NO-2NC	HW◎B-V3P12N1④	
	3NC	HW◎B-V3P03N2④	
	2NO-2NC	HW◎B-V3P22④	
 ø40mm Mushroom HW@B-V4	1NC	HW◎B-V4P01④	R (red) Y (yellow)
	1NO-1NC	HW◎B-V4P11④	
	2NC	HW◎B-V4P02④	
	1NO-2NC	HW◎B-V4P12N1④	
	3NC	HW◎B-V4P03N2④	
	2NO-2NC	HW◎B-V4P22④	
 ø60mm Mushroom HW@B-V5	1NC	HW◎B-V5P01④	R (red) Y (yellow)
	1NO-1NC	HW◎B-V5P11④	
	2NC	HW◎B-V5P02④	
	1NO-2NC	HW◎B-V5P12N1④	
	3NC	HW◎B-V5P03N2④	
	2NO-2NC	HW◎B-V5P22④	

• Pushlock turn reset – Button is maintained when pressed and is reset when turned clockwise.

Sub-assembled Ordering No. Pushlock Turn Reset

Package Quantity: 1

Operator Unit		Contact Unit		
Name / Shape	Part No. (Ordering No.)	Shape	Contact Configuration	Part No. (Ordering No.)
 ø29mm Mushroom HW@B-V3◎	HW◎B-V3◎		1NC	HW-CNP01
			1NO-1NC	HW-CNP11
			2NC	HW-CNP02
			1NO-2NC	HW-CNP12N1
			3NC	HW-CNP03N2
			2NO-2NC	HW-CNP22
 ø40mm Mushroom HW@B-V4◎	HW◎B-V4◎		1NC	HW-CNP01
			1NO-1NC	HW-CNP11
			2NC	HW-CNP02
			1NO-2NC	HW-CNP12N1
			3NC	HW-CNP03N2
			2NO-2NC	HW-CNP22
 ø60mm Mushroom HW@B-V5◎	HW◎B-V5◎		1NC	HW-CNP01
			1NO-1NC	HW-CNP11
			2NC	HW-CNP02
			1NO-2NC	HW-CNP12N1
			3NC	HW-CNP03N2
			2NO-2NC	HW-CNP22
			4NC	HW-CNP04

• Specify a button color code in place of ◎ in the Part No. R (red), Y (yellow)
Note) Y (yellow) cannot be used as a emergency stop switch by EN standards.



Push Pull

Name / Shape	Contact Configuration	<Reference> Assembled Part No.	④ Button Color Code
 ø40mm Mushroom HW1B-Y2	1NC	HW◎B-Y2P01④	R (red) Y (yellow)
	1NO-1NC	HW◎B-Y2P11④	
	2NC	HW◎B-Y2P02④	

• Push-Pull – 2-position switches with button maintained in both depressed and reset positions.
• ◎ Bezel Type: 1: Black, 4: Metal

Push Pull

Package Quantity: 1

Operator Unit		Contact Unit		
Name / Shape	Part No. (Ordering No.)	Shape	Contact Configuration	Part No. (Ordering No.)
 ø40mm Mushroom HW@B-Y2◎	HW◎B-Y2◎		1NC	HW-CNP01
			1NO-1NC	HW-CNP11
			2NC	HW-CNP02

• Specify a button color code in place of ◎ in the Part No. R (red), Y (yellow)
Note) Y (yellow) cannot be used as a emergency stop switch by EN standards.
Note) Only up to 2 contacts can be used for push-pull switches.

For Part No. (Ordering No.) / mounting positions of contact units, see page 781.

Emergency Stop Switches Dimensions

All dimensions in mm.

Dimensions

All dimensions in mm.

**ø29mm Mushroom Pushlock Turn Reset
HW1B-V3**

1 to 2 contacts

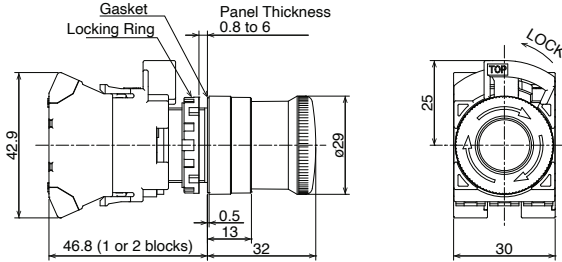

3 to 4 contacts

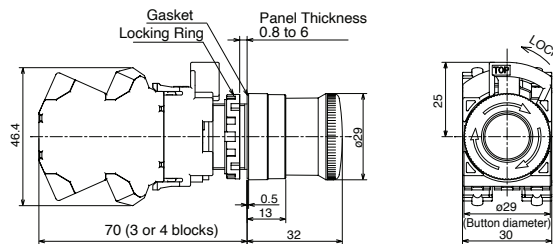

**ø29mm Mushroom Pushlock Turn Reset
HW1B-V4**

1 to 2 contacts

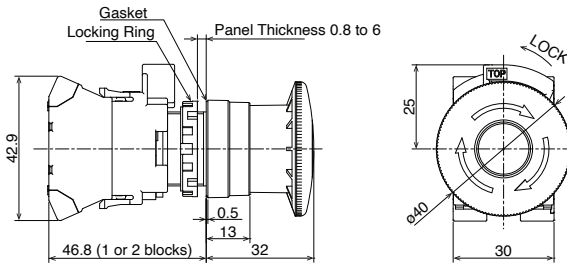

3 to 4 contacts

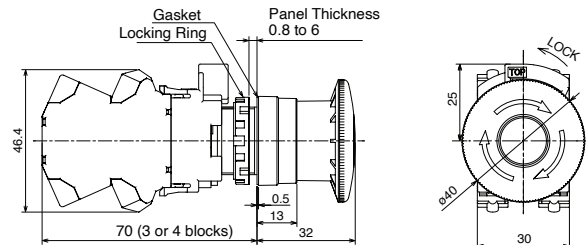

**ø60mm Mushroom Pushlock Turn Reset
HW1B-V5**

1 to 2 contacts

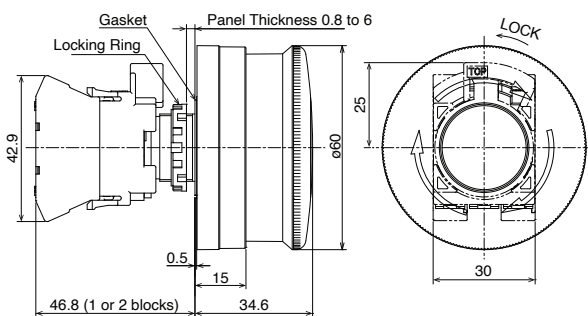

3 to 4 contacts

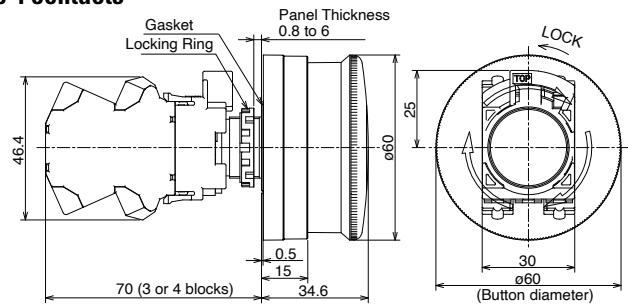

**ø40mm Mushroom Push Pull (2-position)
HW1B-Y2**

1 to 2 contacts

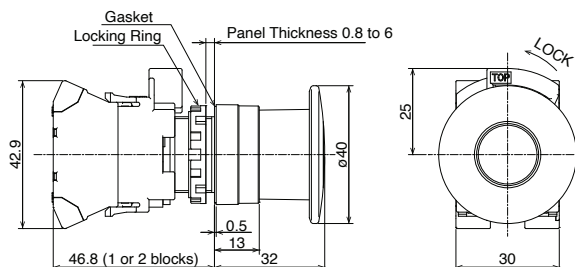

Nameplates

All dimensions in mm

When ordering, specify the Ordering No.

Description	Material	Part No.	Ordering No.	Dimensions (mm)
HWAM Order marking plate (round) separately.	Plastic (black)	HWAM	HWAM	HWNP-□ marking plate (sold separately) is necessary.
			HWAMPN10	
HWAQ Order marking plate (square) separately.	Plastic (black)	HWAQ	HWAQ	HWNP-□ marking plate (sold separately) is necessary.
			HWAQPN10	
HWAS Blank	Plastic (black)	HWAS-0	HWAS-0	
			HWAS-0PN10	

Marking Plates for HWAM/HWAQ

When ordering, specify the Ordering No.

Description	Material	Part No.	Ordering No.	Dimensions (mm)
HWNP	Aluminum (black) Thickness = 1.0mm	HWNP-□	HWNP-□	White legend on black background. Engraving area: W25xH7
			HWNP-□PN10	

- Specify a legend code in place of □ in the Ordering No.

Legends

Code	Legend
0	(blank)
1	ON
2	OFF
3	START
4	STOP
31	OFF-ON
35	HAND-AUTO
53	HAND-OFF-AUTO

- See page 793 for how to install nameplates/marketing plates, and how to remove marking plates.

E-Stop Shrouds

Style	Part Numbers	E-Stop Types	Applicable Standards
	HW9Z-KG1	40mm Mushroom Head	SEMI S2-0703, 12.5.1 Compliant
	HW9Z-KG2	40mm Mushroom Head	SEMI S2-0703, 12.5.1 & SEMATECH Compliant

Style	Part Numbers	E-Stop Types	Applicable Standards
	HW9Z-KG3	40mm Mushroom Head	SEMI S2 Compliant (Approved by TUV) ISO 13850
	HW9Z-KG4	40mm Mushroom Head	SEMI S2 Compliant (Approved by TUV) & SEMATECH ISO 13850

Contact Unit

Contact Unit Part No. / Contact Configuration

Package Quantity: 1

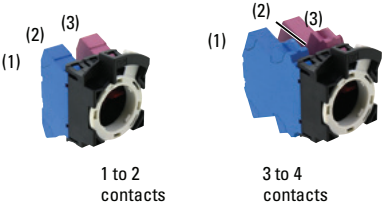
Shape / Contact Block Mounting Position				
				
<p>Note) (2) can only be mounted with a dummy block.</p>				
Contact Configuration (Code)	Part No. (Ordering No.)	Mounting Position	Contact	Component Part No.
1NO (10)	HW-CNP10	(1)	1NO	HW-P10
		(2)	Dummy	CW-DB
		(3)	Dummy	CW-DB
1NC (01)	HW-CNP01	(1)	Dummy	CW-DB
		(2)	Dummy	CW-DB
		(3)	1NC	HW-P01
1NO-1NC (11)	HW-CNP11	(1)	1NO	HW-P10
		(2)	Dummy	CW-DB
		(3)	1NC	HW-P01
1NO-1NC (11N1)	HW-CNP11N1	(1)	1NC	HW-P01
		(2)	Dummy	CW-DB
		(3)	1NO	HW-P10
2NO (20)	HW-CNP20	(1)	1NO	HW-P10
		(2)	Dummy	CW-DB
		(3)	1NO	HW-P10
2NC (02)	HW-CNP02	(1)	1NC	HW-P01
		(2)	Dummy	CW-DB
		(3)	1NC	HW-P01
2NO-2NC (22)	HW-CNP22	(1)	1NO-1NC	HW-PW11
		(2)	Dummy	CW-DB
		(3)	1NO-1NC	HW-PW11
2NO-2NC (22N1)	HW-CNP22N1	(1)	2NO	HW-PW20
		(2)	Dummy	CW-DB
		(3)	2NC	HW-PW02
2NO-2NC (22N2)	HW-CNP22N2	(1)	2NC	HW-PW02
		(2)	Dummy	CW-DB
		(3)	2NO	HW-PW20
Contact Configuration (Code)	Part No. (Ordering No.)	Mounting Position	Contact	Component Part No.
3NO (30N1)	HW-CNP30N1	(1)	2NO	HW-PW20
		(2)	Dummy	CW-DB
		(3)	1NO	HW-P10
3NC (03N2)	HW-CNP03N2	(1)	2NC	HW-PW02
		(2)	Dummy	CW-DB
		(3)	1NC	HW-P01
1NO-2NC (12N1)	HW-CNP12N1	(1)	1NO-1NC	HW-PW11
		(2)	Dummy	CW-DB
		(3)	1NC	HW-P01
1NO-3NC (13)	HW-CNP13	(1)	1NO-1NC	HW-PW11
		(2)	Dummy	CW-DB
		(3)	2NC	HW-PW-02
2NO-1NC (21N3)	HW-CNP21N3	(1)	1NO-1NC	HW-PW11
		(2)	Dummy	CW-DB
		(3)	1NO	HW-P10
3NO-1NC (31)	HW-CNP31N1	(1)	1NO-1NC	HW-PW11
		(2)	Dummy	CW-DB
		(3)	2NO	HW-PW20
1NO-3NC (13)	HW-CNP13	(1)	1NO-1NC	HW-PW11
		(2)	Dummy	CW-DB
		(3)	2NC	HW-PW02
4NO (40)	HW-CNP40	(1)	2NO	HW-PW20
		(2)	Dummy	CW-DB
		(3)	2NO	HW-PW20
4NC (04)	HW-CNP04	(1)	2NC	HW-PW02
		(2)	Dummy	CW-DB
		(3)	2NC	HW-PW02

- Contact unit includes a contact block(s), and a connecting unit.
- Switches with 1 contact block contain 2 dummy blocks. Switches with 2 contact blocks contain 1 dummy block.

Contact Unit

Contact Unit (illuminated) Part No. / Contact Configuration

Package Quantity: 1

Shape / Contact Block Mounting Position

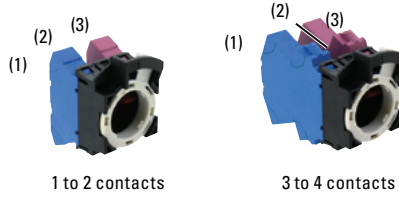

Note) (2) can only be mounted with a dummy block.

Contact Configuration (Code)	Part No. (Ordering No.)	Mounting Position	Contact	Component Part No.
1NO (10)	HW-CNP10Q0	(1)	1NO	HW-P10
		(2)	Full voltage adapter	HW-DP
		(3)	Dummy	CW-DB
1NC (01)	HW-CNP01Q0	(1)	Dummy	CW-DB
		(2)	Full voltage adapter	HW-DP
		(3)	1NC	HW-P01
1NO-1NC (11)	HW-CNP11Q0	(1)	1NO	HW-P10
		(2)	Full voltage adapter	HW-DP
		(3)	1NC	HW-P01
1NO-1NC (11N1)	HW-CNP11N1Q0	(1)	1NC	HW-P01
		(2)	Full voltage adapter	HW-DP
		(3)	1NO	HW-P10
2NO (20)	HW-CNP20Q0	(1)	1NO	HW-P10
		(2)	Full voltage adapter	HW-DP
		(3)	1NO	HW-P10
2NC (02)	HW-CNP02Q0	(1)	1NC	HW-P01
		(2)	Full voltage adapter	HW-DP
		(3)	1NC	HW-P01
2NO-2NC (22)	HW-CNP22Q0	(1)	1NO-1NC	HW-PW11
		(2)	Full voltage adapter	HW-DP
		(3)	1NO-1NC	HW-PW11
2NO-2NC (22N1)	HW-CNP22N1Q0	(1)	2NO	HW-PW20
		(2)	Full voltage adapter	HW-DP
		(3)	2NC	HW-PW02
2NO-2NC (22N2)	HW-CNP22N2Q0	(1)	2NC	HW-PW02
		(2)	Full voltage adapter	HW-DP
		(3)	2NO	HW-PW20

Contact Configuration (Code)	Part No. (Ordering No.)	Mounting Position	Contact	Component Part No.
3NO (30N1)	HW-CNP30N1Q0	(1)	2NO	HW-PW20
		(2)	Full voltage adapter	HW-DP
		(3)	1NO	HW-P10
3NC (03N2)	HW-CNP03N2Q0	(1)	2NC	HW-PW02
		(2)	Full voltage adapter	HW-DP
		(3)	1NC	HW-P01
1NO-2NC (12N1)	HW-CNP12N1Q0	(1)	1NO-1NC	HW-PW11
		(2)	Full voltage adapter	HW-DP
		(3)	1NC	HW-P01
1NO-3NC (13)	HW-CNP13Q0	(1)	1NO-1NC	HW-PW11
		(2)	Full voltage adapter	HW-DP
		(3)	2NC	HW-PW02
2NO-1NC (21N3)	HW-CNP21N3Q0	(1)	1NO-1NC	HW-PW11
		(2)	Full voltage adapter	HW-DP
		(3)	1NO	HW-P10
3NO-1NC (31)	HW-CNP31Q0	(1)	1NO	HW-P10
		(2)	Full voltage adapter	HW-DP
		(3)	1NO-1NC	HW-PW11
1NO-3NC (13)	HW-CNP13Q0	(1)	1NO-1NC	HW-PW11
		(2)	Full voltage adapter	HW-DP
		(3)	2NC	HW-PW02
4NO (40)	HW-CNP40Q0	(1)	2NO	HW-PW20
		(2)	Full voltage adapter	HW-DP
		(3)	2NO	HW-PW20
4NC (04)	HW-CNP04Q0	(1)	2NC	HW-PW02
		(2)	Full voltage adapter	HW-DP
		(3)	2NC	HW-PW02

- Contact unit (illuminated) includes a contact block(s), full voltage adapter, and a connecting unit.
- Switches with 1 contact block contain 2 dummy blocks. Switches with 2 contact blocks contain 1 dummy block.











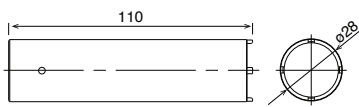

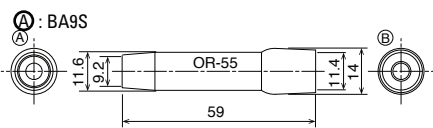

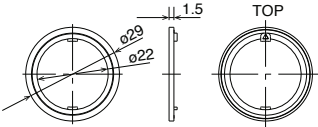
Note) LED lamp is not installed. When ordering a contact unit (illuminated), select a LED lamp from below.

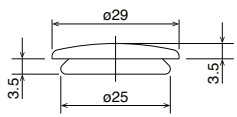
LED lamp (package quantity:1)	
Rated Voltage	Part No. (Ordering No.)
6V AC/DC	LSRD-6
12V AC/DC	LSRD-1
24V AC/DC	LSRD-2
100/120V AC/DC	LSRD-H2
200/220V AC	LSRD-M2
230/240V AC	LSRD-M4

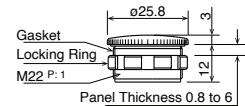
Accessories

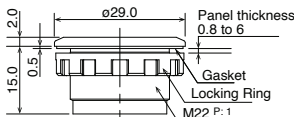
All dimensions in mm

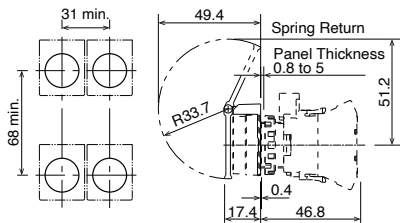

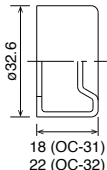
When ordering, specify the Ordering No.

Name / Shape		Material	Part No.	Remarks
Tool	Locking Ring Wrench 	Metal (nickel-plated brass) Weight: approx. 150g	MW9Z-T1	<ul style="list-style-type: none"> Used to tighten the locking ring when installing the HW switch onto a panel. 
	Lamp Holder Tool 	Nitrile rubber (black)	OR-55	<ul style="list-style-type: none"> Used to install and remove the LED lamps. See page 789 for how to install. 
Anti-rotation Ring 		Ring: polyamide Gasket: nitril rubber	HW9Z-RL	<ul style="list-style-type: none"> Used to prevent the operator from turning. Generally used when using no nameplates on selector switches and pushbutton selectors. 
Rubber Mounting Hole Plug 		Nitril rubber (black)	OB-31	<ul style="list-style-type: none"> Degree of protection: IP65 (round hole), IP40 (with anti-rotation function) 
Mounting Hole Plug 		Plug: Metal (Zinc diecast) Locking nut: Polyamide Gasket: Nitrile rubber	LW9Z-BM	<ul style="list-style-type: none"> Degree of protection: IP66 (round hole), IP40 (with anti-rotation function) Tightening torque: 1.2 N·m 
Mounting Hole Plug 		Polyamide	LW9Z-BP1	<ul style="list-style-type: none"> Degree of protection: IP65 Tightening torque: 2.0 N·m 
Switch Guard 	Spring Return	Guard: Polyacetal Cover: polyarylate	HW9Z-K1	<ul style="list-style-type: none"> Used to prevent inadvertent operation for flush pushbuttons. Degree of protection: IP65 Maintained type stops at 90° and 180°. 
	Maintained	Gasket: Nitrile rubber	HW9Z-K11	
Button Clear Boot 	For flush pushbuttons	Rubber (EPDM)	OC-31	<ul style="list-style-type: none"> Used to cover and protect pushbuttons where units are subject to watersplash. Not suitable for outdoor use or where the units are subject to oil splash. Cannot be used with nameplates HWAM, HWAQ, HWAS, or HWAV. 
	For extended pushbuttons		OC-32	

Accessories

All dimensions in mm

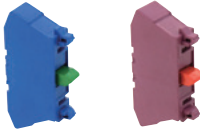
When ordering, specify the Ordering No.

Name / Shape	Material	Part No.	Remarks
Contact Block 	NO contact Housing color: blue	HW-P10	Terminal no.: 1st deck 3-4
	NC contact Housing color: reddish purple	HW-P01	Terminal no.: 1st deck: 1-2
	NO (Early Make) contact Housing color: blue / black	HW-P10R	Terminal no.: 1st deck: 1-2
	2NO contact Housing color: blue	HW-PW20	Terminal no.: 1 deck: 13-14 2 deck: 23-24
	2NC contact Housing color: reddish purple	HW-PW02	Terminal no.: 1 deck: 11-12 2 deck: 21-22
	NONC contact Housing color: blue / reddish purple	HW-PW11	Terminal no.: 1 deck: 13-14 2 deck: 21-22
	NONC (Early Make) contact Housing color: blue / reddish purple	HW-PW1R1	Terminal no.: 1 deck: 13-14 2 deck: 21-22
	2NO (Early Make) contact Housing color: blue / black	HW-PW2R0	Terminal no.: 1 deck: 13-14 2 deck: 21-22
Note) Switches with 1 contact block contain 2 dummy blocks. Switches with 2 contact blocks contain 1 dummy block.			
Full voltage adapter 	Nylon (black)	HW-DP	Terminal No: X1, X2
Connecting unit 	Weight: approx. 9g	HW-CNP	Connecting unit for Push-in terminal
Dummy Block 	Polyamide (black)	CW-DB	Note) Switches with 1 contact block contain 2 dummy blocks. Switches with 2 contact blocks contain 1 dummy block.

Maintenance Parts

All dimensions in mm





When ordering, specify the Ordering No.

Name / Shape		Material/Dimensions	Part No.	Color Code *
	①Round flush	Polyarylate ø23.5 H4.2	HW1A-L1-*	R (red), G (green), Y (yellow), A (amber), C (clear), S (blue)
	②Square flush	Polyarylate ø24.6 H4	HW2A-L1-*	
	③Round extended	Polyarylate ø23.3 H10	HW1A-L2-*	
	④ø29 mushroom	AS, marking type ø29 H12.7	ALW31LD-*	
	⑤ø40 mushroom	AS, marking type ø40 H12.7	ALW41LD-*	
	⑥Dome for pilot light	AS ø23.5 H15.1	HW1A-P2-*	
	①Round flush with round or square bezel	Polyacetal ø23.6 H3	HW1A-B1-*	<ul style="list-style-type: none"> • Use ① for Selector pushbuttons B (black), G (green), R (red), Y (yellow), S (blue), W (white)
	②Round extended with round or square bezel	Polyacetal ø23.6 H9.2	HW1A-B2-*	
	③Square flush	Polyacetal □24.8 H3	HW2A-B1-*	
	④Square extended	Polyacetal □24.5 H9.2	HW2A-B2-*	
	⑤ø29 mushroom	Polyacetal ø29 H12.7 (M18P1.0)	HW1A-B3-*	
	⑥ø40 mushroom	Polyacetal ø40 H12.7 (M18P1.0)	HW1A-B4-*	
	Round flush	Acrylic ø21.5 Thickness = 1	HW9Z-P11	<ul style="list-style-type: none"> • White • See page 63 for dimensions and engraving area.
	Round extended	Acrylic ø21.3 Thickness = 6.5	HW9Z-P12	
	Square flush	Acrylic 22.7 Thickness = 1	HW9Z-P21	
	ø29/40 mm mushroom	Acrylic ø15.7 H3.4	ALW3B	
Operator Knob for Illuminated Selector Switch	AS resin		HW9Z-FDY*	R (red), G (green), Y (yellow), A (amber), W (white), S (blue)
Operator Lever for Illuminated Selector Switch			HW9Z-FDL*	
Spare Key (Disc Tumber Key)	Metal (nickel-plated brass)		HW9Z-SKP	

Maintenance Parts

All dimensions in mm

When ordering, specify the Ordering No.

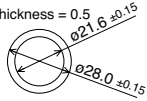
Name / Shape	Material/Dimensions	Part No.	Remarks
Spare Key (Pin Tumbler Key) 	Metal (nickel-plated brass)	LW9Z-SK-500	• Standard key number
		LW9Z-SK-<input type="text"/>	• Key number <input type="text"/> : 501 to 515
Locking Ring 	Polyamide (black) ø28.4 H5 M22P1	HW9Z-LN	
Cap for Mono-lever Switch 	Standard Nitril rubber ø10 L20	HW9Z-CPM	
Boot for Mono-lever Switch 	Standard Nitril rubber ø29.2 L34.4	HW9Z-BLM	
Gasket 	Nitril rubber (black)	HW9Z-WM	Thickness = 0.5 

HW Series LED Lamps

When ordering, specify the Ordering No.

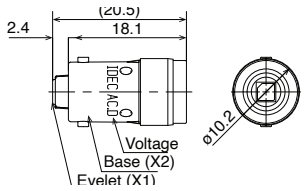
Shape/Dimensions	Operating Voltage	Current Draw		Part No.	Base
		DC	AC		
 	6V AC/DC	10mA	14mA	LSRD-6	BA9S/13
	12V AC/DC	7mA	8mA	LSRD-1	
	24V AC/DC	7mA	8mA	LSRD-2	
	100/120V AC/DC	2mA	2mA	LSRD-H2	
	200/220V AC	2mA	2mA	LSRD-M2	
	230/240V AC	2mA	2mA	LSRD-M4	

⚠ Safety Precautions

- Turn off the power to the HW series switches & pilot lights before starting installation, removal, wiring, maintenance, and inspection of the products. Failure to turn power off may cause electrical shocks or fire hazard.
- To avoid a burn on your hand, use the lamp holder tool when replacing lamps.

- For wiring, use wires of a proper size to meet the voltage, current requirements, and the number of connectable wires (page 795). Failure to tighten the terminal screws may cause overheating and fire.
- Avoid using in places mentioned below to maintain performance of the product.
 - Exposed to direct sunlight
 - Subject to corrosive or flammable gases

Instructions

Panel Mounting

1. Remove the contact block from the operator.
2. Remove the locking ring from the operator
3. Insert the operator into the panel cut-out from the front. When mounting the nameplate, insert between the operator and panel.
4. Tighten the locking ring from the back.

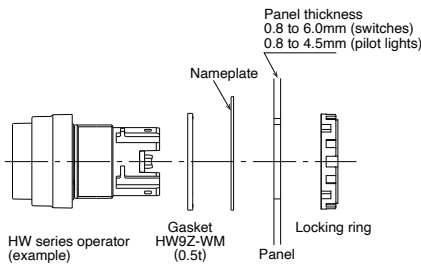

Mounting panel thickness is reduced by 1.5 mm when using a nameplate.

Removing the Contact Block

1. Remove the operator from the contact block by pushing and turning the locking lever in the direction of the arrow shown below. Then the operator can be pulled out.
2. To reinstall, place the TOP marking on the operator and the lock lever in the same direction, and insert the operator into the contact block mounting adapter. Then turn the locking lever in the opposite direction.



Anti-rotation Ring and Mounting Panel

Turn the TOP marking on the operator and the ▲ mark on the anti-rotation ring to the recess on the mounting panel.

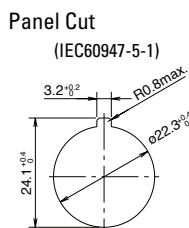
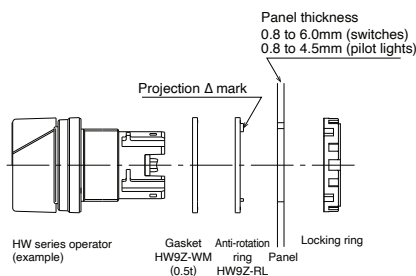

Installing the Pilot Light

Detach the operator unit from the LED unit. After mounting the operator from the front of the panel, attach the LED unit.

Installing / Removing the LED Unit

1. Detach the LED unit by lifting the latch using a small flat blade screwdriver width 0.5mm max.
2. To install, align the TOP marking on the operator with the TOP marking on the LED unit.

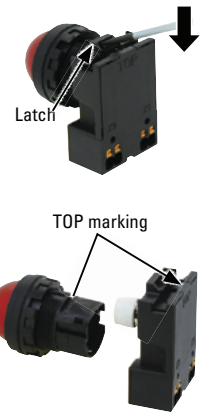

Notes for Panel Mounting

Locking ring wrench recommended torque
Tighten the bezel to a tightening torque of 2.0 N·m.

Locking ring wrench (MW9Z-T1) can be used to tighten the bezel. Do not use pliers. Excessive tightening will damage the locking ring.



Locking ring wrench (MW9Z-T1)

Panel Thickness

HW series can be mounted on a panel with thickness of 0.8 to 6.0 mm (switches) and 0.8 to 4.5 mm (pilot lights). Take the thickness of nameplate and/or switch guard into consideration.

Instructions

Replacing LED Lamps

Lamps can be replaced using the lamp holder tool (OR-55) from the front of the panel, or by removing the contact block from the operator unit. (See page 783 for lamp holder tool.)

Removing the LED lamp from the front of the panel

Removing

To remove, slip the lamp holder tool onto the lamp head lightly. Then push slightly, and turn the lamp holder tool counterclockwise.

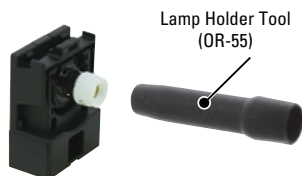

Installing

Insert the lamp head into the lamp holder tool.

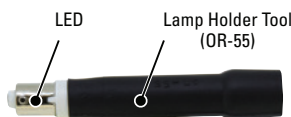

Place the pins on the lamp base to the grooves in the lamp socket. Insert the lamp and turn it clockwise.

Removing and Installing the Contact Blocks, Dummy Blocks, and LED Units

Removing

To remove the contact block and dummy block, insert into the flat blade screwdriver latch and move in the direction of the arrow.

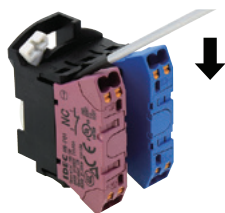

Installing

When installing the contact block or dummy block, make sure that it snaps on to the operator.

For No. 1 and 3 only a contact block or dummy block can be installed. For No. 2, only a dummy block can be installed.

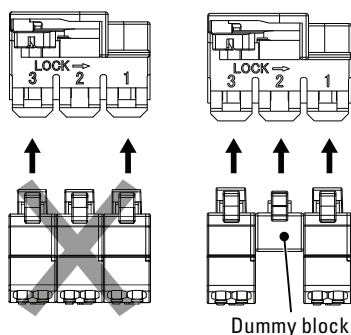

Note) Make sure to attach a correctly assembled connection unit to the operator.

Note) When attaching the contact block to the connection unit, make sure that the connection is detached from the operator. If a contact block is installed with the operator attached to the connection unit, malfunction of the switch may occur.

Note) Full voltage adapters cannot be removed or attached with contact blocks attached.

Note) Attach the full voltage adapter vertically to the connection unit.

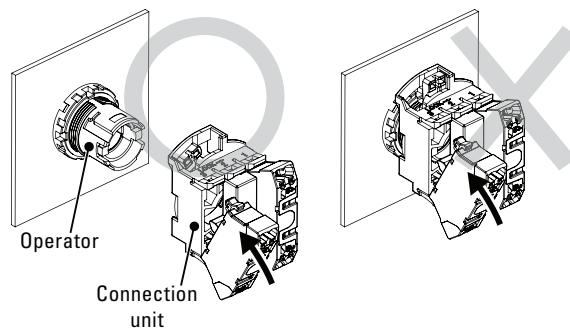

Test Points

Note) Do not insert wires into the test point.

Single contact block

Note) When conducting a continuity test on the contact block, make sure that probes (ø2.0 maximum) of the tester are inserted vertically to the panel.

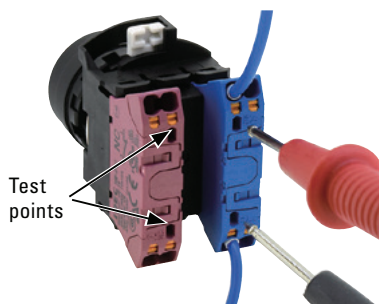

Double contact block

When conducting a continuity test on the first deck, make sure that probes (ø2.0 maximum) of the tester are inserted in an angle of the contact block, in two places as shown below.

When conducting a continuity test on the second deck, make sure that probes (ø2.0 maximum) of the tester are inserted vertically to the panel.

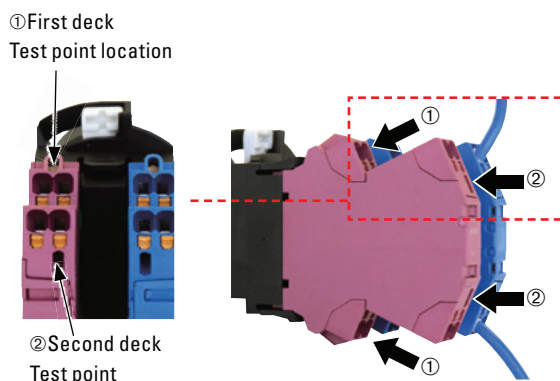

Instructions

Installing/Removing the Buttons and Lenses

<To install>

<To remove>

Pushbutton Button

• Flush/Extended

Push in the button to install.



Insert a flat screwdriver between the button and the bezel to remove the button.

• Mushroom/Jumbo Mushroom

Button has threads. Turn clockwise to install the button.



Turn the button counterclockwise to remove.

Note: Jumbo mushroom button cannot be removed.



Illuminated Pushbutton Lens

• Flush/Extended

Push in the lens holder into the operator unit.



Insert a flat screwdriver between the button and the bezel to remove the lens holder.



• Mushroom/Jumbo Mushroom

Lens has threads. Turn clockwise to install the lens.



Lens has threads. Turn counterclockwise to remove the lens.



Pilot Light Lens

• Extended

Lens has threads. Turn clockwise to install the lens.



Turn the lens counterclockwise to remove.



• Square Flush

Push in the lens holder into the operator unit.



Insert a flat screwdriver between the lens and the bezel to remove.



Installing/Removing the Lenses and Marking Plates

Removing

Removing the lens unit

Insert a flat screwdriver in groove of the lens (TOP mark side of the operator or opposite side) to remove the lens unit (lens/marking plate/ lens holder).



Removing the lens

Remove the lens by pushing the lens from the rear to disengage the latches between the lens and the lens holder, using a flat screwdriver as shown below.

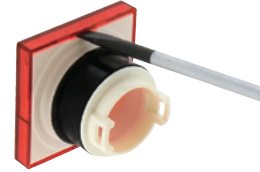

Note: The translucent filter in the lens holder cannot be removed because this filter is sealed to make the unit waterproof and oiltight.

Installing

1. Place the marking plate on the lens holder with the anti-rotation projection engaged and press the lens onto the lens holder to engage the latches.
2. Place the marking plate in the correct orientation.

For Square Lens (square flush lens)
*Note the orientation of the parts.

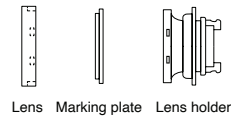

Instructions

Using a Ring Adapter

HW9Z-A25

Install the ring adapter between the HW series unit and panel. Make sure that the side with ridges face the panel.



Nitril Rubber

Dimensions

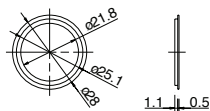

Panel Cut-out

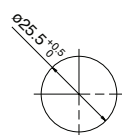

Installation

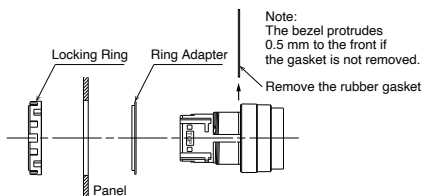

HW9Z-A30

The ring adapter HW9Z-A30 consists of a washer and adapter. Install adapter between the HW series unit and panel. Install washer between the locking ring and panel.



Washer: metal (brass)



Adapter: polyamide

Dimensions

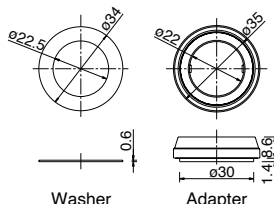

Panel Cut-out

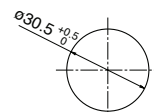

Installation

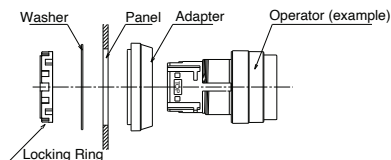

Dual Pushbutton Switches

The pushbuttons cannot be removed or replaced. Do not attempt to remove using a flat screwdriver or pincers, otherwise the pushbuttons may be damaged.

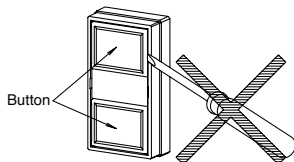

Installing the Rubber Boot for Dual Pushbuttons

When using the HW7D pushbuttons in places where the pushbuttons are subject to water splash or an excessive amount of dust, make sure to use the HW9Z-D7D rubber boot (IP65) which is ordered separately. Remove the rubber gasket pre-installed on the operator, and install the rubber boot from the front of the button.

Notes for Installing the Rubber Boot

Remove the gasket from the operator, and install the rubber boot on the operator. Pull out the seals of the rubber boot and place them around the operator sleeve as shown. Make sure that the seals are not twisted or tucked inside and that the gasket does not remain, otherwise the normal waterproof and dustproof characteristics are not ensured.

- ① Remove the gasket.
- ② Install the rubber boot on the pushbuttons

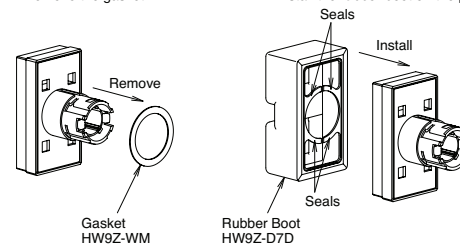

Rubber Boot Installed

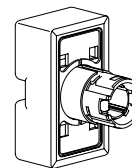

Selector Switches

Turn the operator such as knob, lever, and key to each position accurately. Releasing halfway may cause the operator to return to the former position, or to get stuck between. On spring return two-way types, the center of operators may be misaligned slightly.

Key Selector Switches

Observe the following instructions to prevent malfunction or damage.

- Turn the key securely to each position.
- Insert the key to the bottom of the key hole.
- Do not remove the key from any key retained position.
- Use a key that matches with the number on the key cylinder. However, for standard keys, the key number is engraved on the key but not on the key cylinder.

Marking

For HW series pilot lights, legends and symbols can be engraved on the built-in marking plates, or printed film can be inserted under the lens for labeling purposes.

Marking plate and marking film size (mm)

Built-in marking plate and engraving area	Applicable marking film size
Outside diameter: □22.7 Engraving depth: 0.5mm max.	 Two 0.1 mm-thick films or one 0.2 mm-thick film

*Marking films are not supplied.

Insertion Order of Marking Plate and Film

Square Lens (Square flush lens)

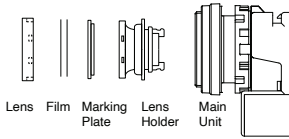

Note: Films are not supplied. When inserting a film, make sure that the marking plate is installed with its uneven side facing the lens holder.

Nameplate

Mounting panel thickness is reduced by 1.5 mm when using a nameplate.

Installing a Marking Plate

Insert a marking plate in the direction of the arrow ①, and press in as shown ②.

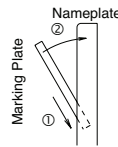

Removing a Marking Plate

Insert a flat screwdriver into the upper middle part of the marking plate and remove. When anti-rotation is not required, remove the projection from the nameplate using pliers.

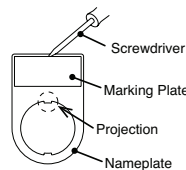

Applicable Wire

When wiring, use the applicable wires shown below.

Applicable Wire and Specifications

Applicable Wire (*1)	0.25 to 1.5mm ² (AWG16 to 24)
Wire Strip Length (*2)	8 ± 1mm (*3)
Ferrule Size (*3) (Weidmüller)	H0.25 to H1.5 (without insulated cover)
	H0.25 to H1.5 (with insulated cover)

*1) For applicable wires confirmed by IDEC, see website.

*2) For details on ferrules, see "Wire Size and Recommended Ferrules" table below.

*3) Strip the sheath of the wire 8±1mm from the end.



Note: Make sure that the stranded wires do not loosen when using wiring without ferrules.

Wire Size and Recommended Ferrules

Ferrules without insulated covers

Applicable Wire (Stranded Wire)		Wire Strip Length	Weidmüller Recommended Part No.
AWG	mm ²		
24	0.25	5 to 6mm	H0.25/5
20	0.50	10 to 11mm	H0.5/10
18	0.75	10 to 11mm	H0.75/10
18	1.00	10 to 11mm	H1.0/10
16	1.50	10 to 11mm	H1.5/10

Ferrules with insulated covers

Applicable Wire (Stranded Wire)		Wire Strip Length	Weidmüller Recommended Part No.
AWG	mm ²		
24	0.25	10 to 11mm	H0.25/12 HBL
22	0.34	10 to 11mm	H0.34/12 TK
20	0.50	10 to 11mm	H0.5/14 OR
18	0.75	10 to 11mm	H0.75/14 W
18	1.00	10 to 11mm	H1.0/14 GE
16	1.50	10 to 11mm	H1.5/14 R

Recommended Tools (Optional)

Name	Weidmüller Recommended Part No.
Crimping tool	PZ 6 ROTO L
Flat blade screwdriver	SDS 0.4×2.0×60
	SDS 0.4×2.5×75

Note 1) Note the crimping dimensions. When using tools other than the recommended crimping tool. For details, see page 793.

Note 2) Use a flat blade screwdriver with a blade size of 0.4×2 to 2.5 mm.

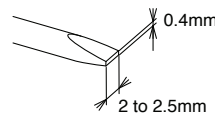

Wiring Procedure

Connecting the wire

Stranded wires with ferrules or solid wire

- ① Insert the wire to the back of the wire port.
- ② After wiring, tug lightly to make sure that the wire is properly connected.

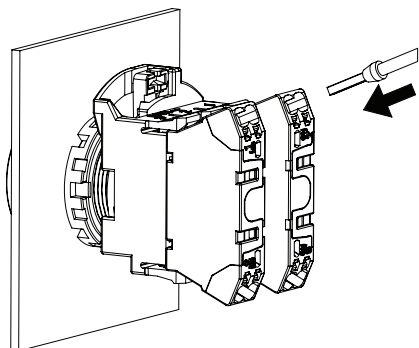

Stranded wire

- ① While pressing the pusher (orange button) using a flat blade screwdriver (recommended: SDS 0.4x2.0x60 (optional)). Insert the wire fully in the wiring port. Wire is connected when the pusher is released.
- ② After wiring, tug lightly to make sure that the wire is properly connected.

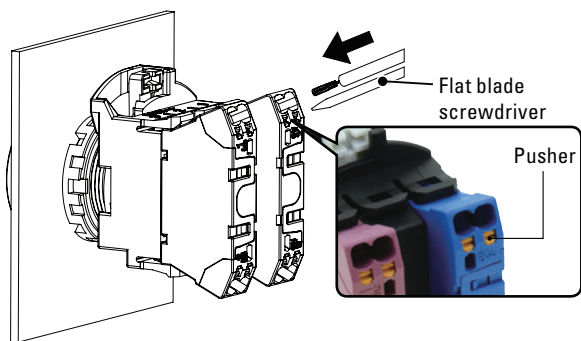

Crimping of Ferrules and Wiring

- Choose an appropriate ferrule for the wire.
- Cut the wire carefully to get a flat end.
- Make sure that ferrule sleeve is completely filled by the conductor. Depending on the cross section, the conductor should protrude approx. 0 to 1 mm from the ferrule sleeve.

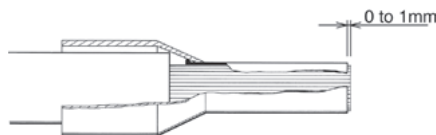

- When crimping, refer to the instructions of the crimping tool.

Faults which can occur during crimping:

- Cracks along the sides and die impressions
- Splitting of the ferrules
- Asymmetrical crimping shape
- Extreme burrs formed along the sides
- Ferrule not filled by conductor
- Single conductors pushed back by protruding from the insulated cover
- Single conductors squeezed off
- Insulation cover damaged by the crimping jaw
- Conductor insulation not pushed into the insulated cover
- Ferrule bent longitudinally after crimping

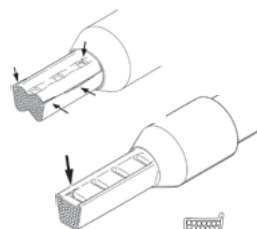

Formation of cracks at the sides.
Sides spilt open
Formation of cracks at the impressions of the crimping jaw

Asymmetrical crimping shape.
Burr formation on one side

Asymmetrical crimping shape.
Burr formation on one side

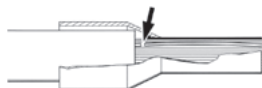

Single conductor squeezed off

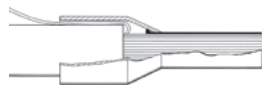

Single conductor pushed back

Instructions

Crimping dimensions: W2.4×H1.9 mm

Maximum connectable crimping size is W2.4×H1.9. Make sure that the ferrule size will be smaller than this dimension. (Recommended crimping tool: PZ 6 Roto (optional) Weidmüller)

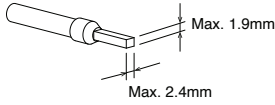

- Note 1) If a tool other than the recommended crimping tool is used, the ferrule may not be crimped to the appropriate size and the clamp or spring inside the contact block may be deformed and may not operate normally.
- Note 2) Pin crimp terminals cannot be used.

Removing the Wire

When removing the wire, push the pusher using a flat blade screwdriver (recommended: SDS 0.4×2.0×60) and pull wire out in the direction of the arrow.

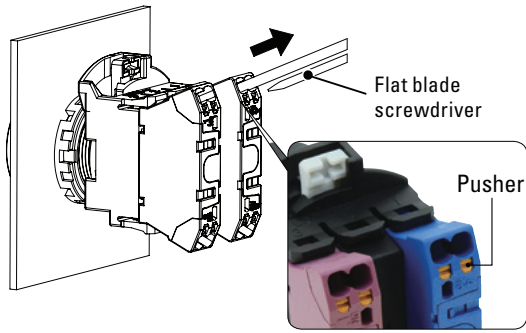

<Notes>

- Operate the pusher with a force of 20N. Do not press excessively. Otherwise, the switch may be damaged.
- Do not pull the wire out without depressing the pusher. When pulling the wire, be sure to pull in a straight direction. Otherwise, the socket may be damaged.

Number of Connectable Wires

Unit	Connectable wires		No. of connectable wires
HW-P Contact block	Solid wire	0.25 to 1.5mm ² (AWG16 to 24)	2
	Stranded wire	0.25 to 1.5mm ² (AWG16 to 24)	
Pilot light	Ferrule	Without insulated cover 0.25mm ² : conductor length: 5 to 10mm 0.5 to 1.0mm ² : conductor length: 6 to 10mm 1.5mm ² : conductor length 8 to 10mm With insulated cover 0.25 to 1.0mm ² : conductor length 6 to 10mm 1.5mm ² : conductor length 8 to 10mm Note) Pin terminals cannot be used	

Note) Only one wire can be inserted into one wire port.

Instructions (Emergency Stop Switches)

When using the HW series control units in a safety-related circuit of a control system, observe safety rules and regulations of each country concerning particular applications of the actual machines and facilities. Perform risk assessment before operation to ensure safety.

Chattering / Contact Bounce

When the button is reset by pulling or turning, the NC main contacts will bounce. When pressing the button, the NO monitor contacts will bounce. When designing a control circuit, take the contact bounce time into consideration (reference value: 20 ms). Also, do not apply shock to the switch as chattering may occur.

Nameplate or Switch Guard

When anti-rotation is not required, remove the projection from the nameplate or switch guard using pliers. Mechanical indicator types have projections on the operator. Make sure to remove the projection on the nameplate or switch guard.

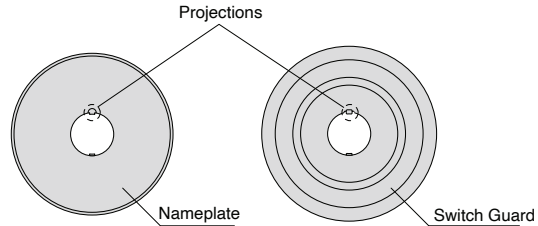

Handling

Do not expose the switch to excessive shocks and vibrations, otherwise the switch may be deformed or damaged, causing malfunction or operation failure.

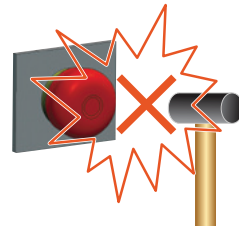

Instructions (Illuminated / Non-illuminated Buzzers)

Installing the terminal rubber boot

1. Cut the end of terminal rubber boot to fit the cable size.
2. Insert the cable into the terminal rubber boot in the direction of arrow shown below.

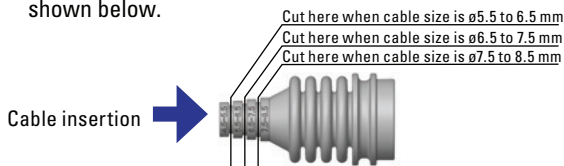

3. Strip the insulation of the cable 30 mm from the end and wire as instructed in "Wiring".
4. Install the terminal rubber boot as shown below.

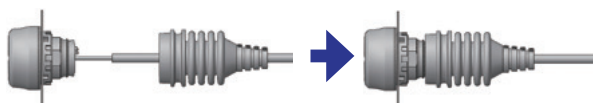

5. Cover part B with part A.

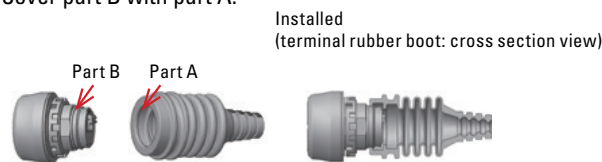

6. Make sure that the bellows is 17 to 22 mm long.

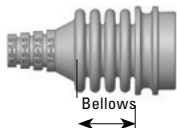

Note for terminal rubber boot

- Be sure to use bellows with an appropriate length. Otherwise, waterproof characteristics cannot be achieved.
- Maintain a cable angle of 45° maximum to the axis of the buzzer, otherwise the terminal rubber boot may come off.

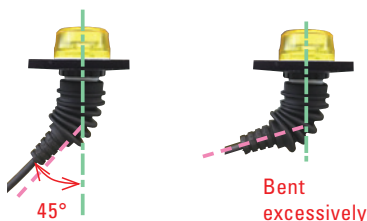

Panel Mounting

- Insert the buzzer into the panel cut-out from the front, and tighten the locking ring from the back.

Note for panel mounting

- Use the optional locking ring wrench (MW9Z-T1) to tighten the locking ring to a recommended tightening torque of 1.5 to 2.0 N·m.
- Do not use pliers and do not tighten excessively, otherwise the buzzer may be damaged.

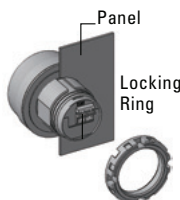

Wiring Procedure

Connecting the wire

Solid wire

Strip the insulation of the cable from 8mm from the end and insert into the wire port. After wiring, tug lightly to make sure that the wire is properly connected.

Stranded wire with ferrule

Crimp a ferrule with a conductor length of 8mm and insert to the back of the wire port. After wiring, tug lightly to make sure that the wire is properly connected.

Stranded wire

Strip the wire insulation 8mm from the end and push in the wire release pin above the wire port using a small flat screwdriver. Release the wire release pin. Make sure that the wire does not loosen.

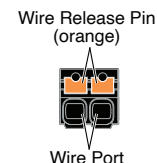

Wire removal

Push in the orange color wire release pin above the wire ports using a small flat screw driver, and pull out the wire.

Flat blade screwdriver

Use a flat blade screwdriver blade size 2.5mm

Notes for wiring

- Make sure that the terminal is not constantly pulled by the wire.
- Wiring must be performed in environments of -5 to +50°C.
- Do not damage the conductor wire when stripping the wire insulation.
- Do not use wires with bent or deformed conductor wires. Deformed wiring may cause failures such as strength degradation and overheating. Connect one wire per terminal. Connecting two wires to a terminal may cause loose wiring and strength degradation.
- Do not solder the conductor lines. Connecting soldered stranded wires may cause loose wiring and strength degradation.
- If a stranded wire has loose wires, twist the conductor wires before connection. However be careful not to twist excessively.

S³ Connect[®] Push-in Wiring Enabled Product Selection Guide

Switches & Pilot Devices

Signaling Lights





Relays & Sockets

Timers

Contactors

Terminal Blocks

Circuit Breakers

Switches		Relay Sockets		PLCs & Modules	Safety Control Module	
HW Series	CW Series	RU Series	RJ Series	FC6A Series	HR6S series	HR5S series
						
22mm Industrial Heavy-duty Switches	22mm Industrial Switches with Flush Mount Bezel	2 or 4 pole Din rail mount sockets for industrial relays and timers	Space-saving 1 or 2 pole Din rail mount sockets for industrial relays	Powerful and compact controller with industrial protocols and IIoT features	Safety control modules with diagnostic outputs	The first CAT 2 safety control module in the industry
Push buttons and dual pushbuttons	Push buttons with thin bezel	Fit RU series relays and GT5Y timers	Fit RJ or RF2 series relays	FC6A All-in-one models FC6A Plus models	Advanced diagnostic and output functions	Ideal for low risk applications
Illuminated push buttons	Illuminated push buttons	2 pole model P/N: SU2S-21L	1 pole model P/N: SJ1S-21L		Connect to various safety input devices	Front access push-in wiring terminals
Selector switches	Selector switches	4 pole model P/N: SU4S-21L	2 pole model P/N: SJ2S-21L		Screw clamping or push-in wiring terminals	Slim body
Key switches	Key switches	IP20	IP20			
Pilot Lights	Pilot Lights					
Illuminated selector	USB & RJ45 Ports					
Selector push buttons	IP65 & Type 4X					
Monolever switches						
Emergency stop switches						
Illuminated buzzers						
IP65 & Type 4X						
 Safe Simple Smart				RFID Reader & Tags KW2D  RFID Solution for industrial authentication & access control KW2D RFID Reader RFID Fobs and tags IP65/67		Tools & Accessories  Crimping tool Wire stripping tool Ferrules

www.IDEC.com/usa

Technical Support
 support@IDEC.com
 crossref@IDEC.com

800-262-IDEC (4332)

800.262.4332



www.IDEC.com/usa

All trademarks and registered trademarks described in this brochure are the property of their respective owners.