

# SVxx20xxQ Series

## 20 Amp High Junction Temperature SCRs

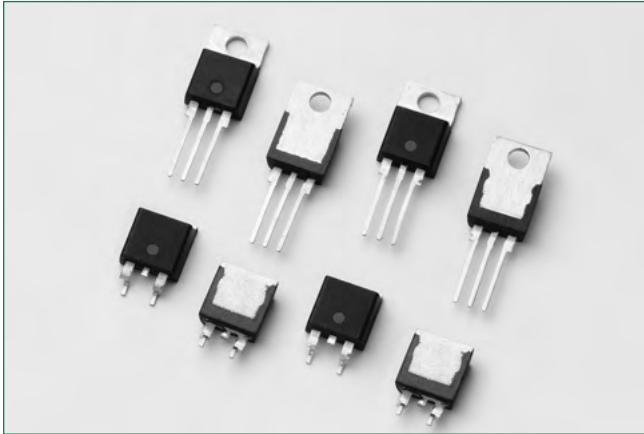

### Agency Approval

Agency	Agency File Number
	L Packages: E71639

### Main Features

Symbol	Value	Unit
$I_{T(RMS)}$	20	A
$V_{DRM}/V_{RRM}$	600	V
$I_{GT}$	6 to 10	mA

### Schematic Symbol

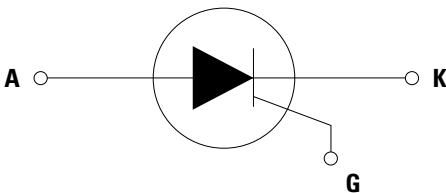

### Description

The SVxx20xxQ high temperature SCR series is ideal for uni-directional switch applications such as phase control in heating, motor speed controls, converters/rectifiers and inrush current controllers.

These SCRs have a low gate current, ( $I_{GT}$ ) trigger level of 6mA and 10mA maximum at approximately 1.5V for SVxx20x1Q and SVxx20x2Q, respectively.

### Features & Benefits

- Halogen free and RoHS compliant
- 150 °C maximum junction temperature
- Surge capability up to 300A at 60 Hz half-cycle
- High dv/dt performance
- Low turn off time
- UL Recognized to UL 1557 as an Electrically Isolated Semiconductor Device

### Applications

Typical applications include AC Generator (ACG) rectifiers, battery voltage regulators, generic converters and inrush current controller in various AC to DC applications. Additional applications include controls for power tools, home/brown good and white goods appliances.

Internally constructed isolated packages offered for ease of heat sinking with high isolation voltage.

# SVxx20xxQ Series

## 20 Amp High Junction Temperature SCRs

### Absolute Maximum Ratings — 20A SCR

Symbol	Parameter	Test Conditions	Value	Unit
$V_{DSM}/V_{RSM}$	Peak non-repetitive blocking voltage	$P_W = 100 \mu s$	800	V
$I_{T(RMS)}$	RMS on-state current	SVxx20LxQ $T_C = 105^\circ C$	20	A
		SVxx20RxQ $T_C = 130^\circ C$		
		SVxx20NxQ		
$I_{T(AV)}$	Average on-state current	SVxx20LxQ $T_C = 105^\circ C$	12.8	A
		SVxx20RxQ $T_C = 130^\circ C$		
		SVxx20NxQ		
$I_{TSM}$	Peak non-repetitive surge current	single half cycle; $f = 50Hz$ ; $T_J(\text{initial}) = 25^\circ C$	250	A
		single half cycle; $f = 60Hz$ ; $T_J(\text{initial}) = 25^\circ C$	300	
$I^2t$	$I^2t$ Value for fusing	$t_p = 8.3 ms$	374	$A^2s$
$di/dt$	Critical rate of rise of on-state current	$f = 60Hz$ ; $T_J = 150^\circ C$	125	$A/\mu s$
$I_{GM}$	Peak gate current	$T_J = 150^\circ C$	4	A
$P_{G(AV)}$	Average gate power dissipation	$T_J = 150^\circ C$	0.8	W
$T_{stg}$	Storage temperature range	-	-40 to 150	$^\circ C$
$T_J$	Operating junction temperature range	-	-40 to 150	$^\circ C$

Note: xx=voltage/10, x=sensitivity

### Electrical Characteristics ( $T_J = 25^\circ C$ , unless otherwise specified)

Symbol	Test Conditions	SVxx20x1Q	SVxx20x2Q	Unit	
$I_{GT}$	$V_D = 12V$ ; $R_L = 60 \Omega$	MIN.	2	mA	
		MAX.	6		
$V_{GT}$		MAX.	1.5	V	
$dv/dt$	$V_D = 67\% V_{DRM}$ ; gate open; $T_J = 125^\circ C$	MIN.	400	$V/\mu s$	
	$V_D = 67\% V_{DRM}$ ; gate open; $T_J = 150^\circ C$		200		
$V_{GD}$	$V_D = V_{DRM}$ $R_L = 3.3 k\Omega$ $T_J = 110^\circ C$	MIN.	0.2	V	
$I_H$	$I_T = 200mA$ (initial)	MAX.	25	40	mA
$t_q$	$I_T = 2A$ ; $t_p = 50\mu s$ ; $dv/dt = 5V/\mu s$ ; $di/dt = -30A/\mu s$	MAX.	12	12	$\mu s$
$t_{gt}$	$I_G = 2 \times I_{GT}$ $PW = 15\mu s$ $I_T = 40A$	TYP.	2.6	2.6	$\mu s$

### Static Characteristics

Symbol	Test Conditions	Value	Unit	
$V_{TM}$	$I_T = 40A$ ; $t_p = 380\mu s$	MAX.	1.65	V
$I_{DRM} / I_{RRM}$	$V_{DRM} / V_{RRM}$	$T_J = 25^\circ C$	10	$\mu A$
		$T_J = 125^\circ C$	1000	
		$T_J = 150^\circ C$	4000	

### Thermal Resistances

Symbol	Parameter	Value	Unit
$R_{\theta(JC)}$	Junction to case (AC)	SVxx20RxQ	1.0
		SVxx20NxQ	
		SVxx20LxQ	2.5

Note: xx=voltage/10, x=sensitivity

# SVxx20xxQ Series

## 20 Amp High Junction Temperature SCRs

**Figure 1: Normalized DC Gate Trigger Current vs. Junction Temperature**

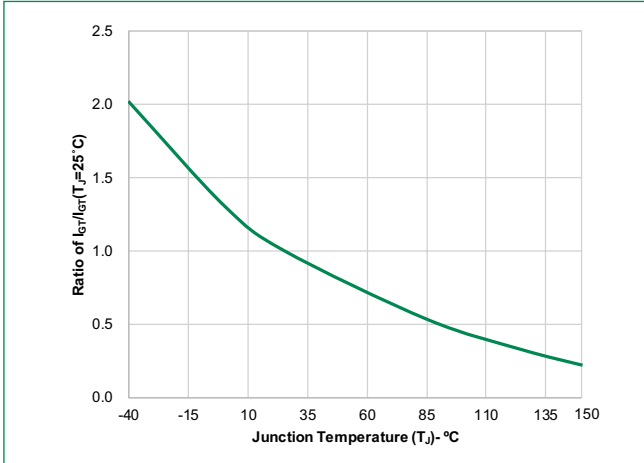

**Figure 2: Normalized DC Gate Trigger Voltage vs. Junction Temperature**

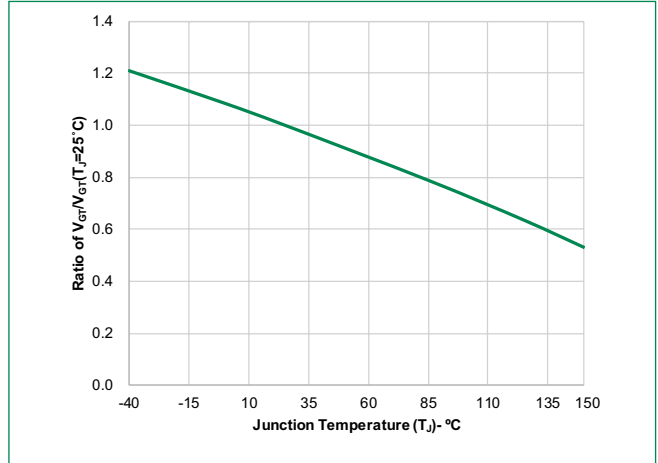

**Figure 3: Normalized DC Holding Current vs. Junction Temperature**

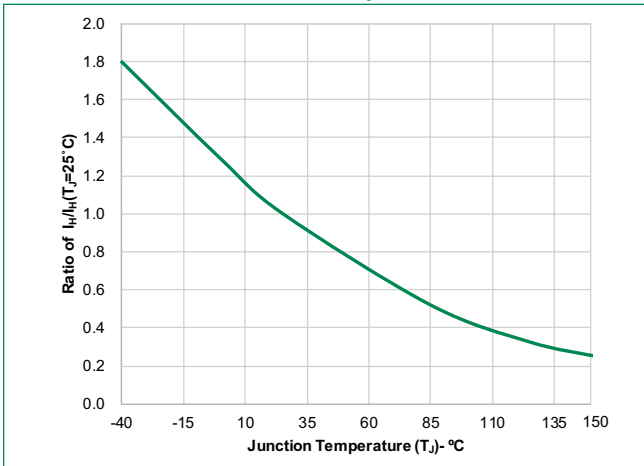

**Figure 4: On-State Current vs. On-State Voltage (Typical)**

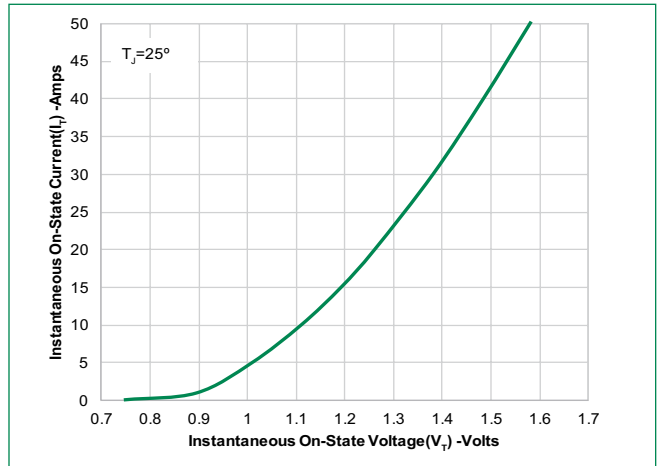

**Figure 5: Power Dissipation (Typical) vs. RMS On-State Current**

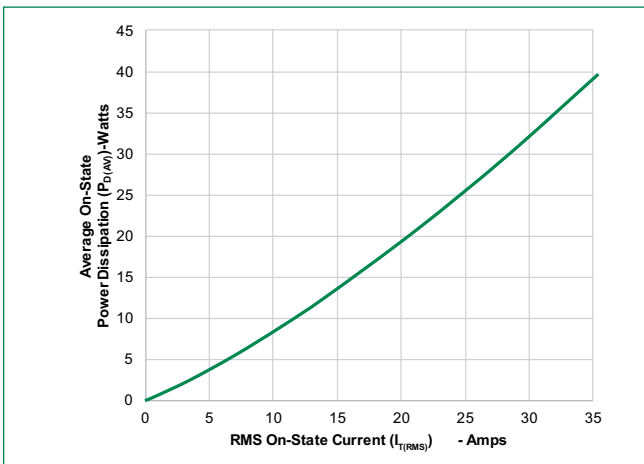

**Figure 6: Maximum Allowable Case Temperature vs. RMS On-State Current**

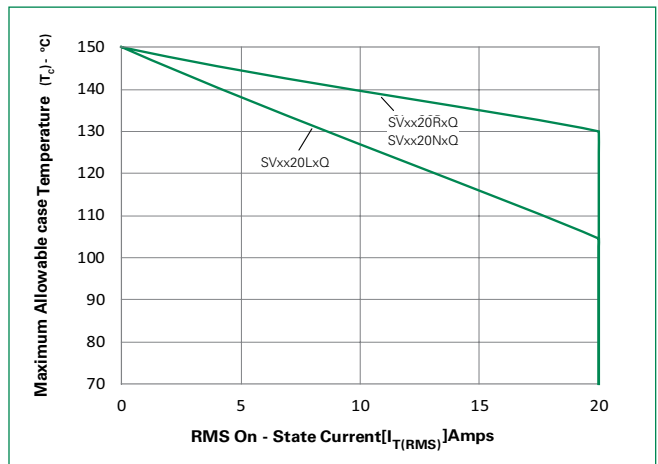

# SVxx20xxQ Series

## 20 Amp High Junction Temperature SCRs

**Figure 7: Maximum Allowable Case Temperature vs. Average On-State Current**

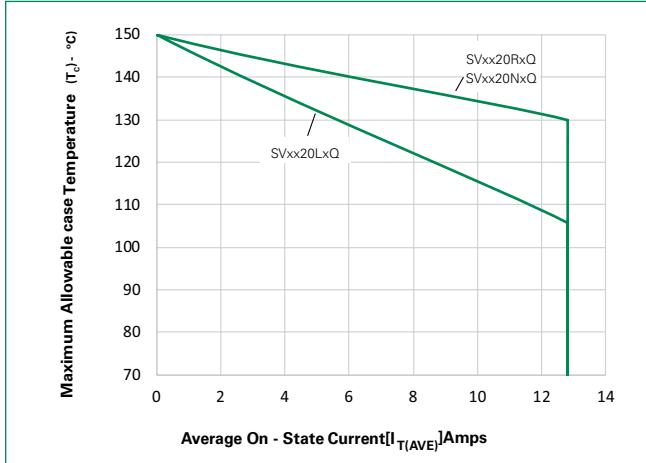

**Figure 8: Peak Capacitor Discharge Current**

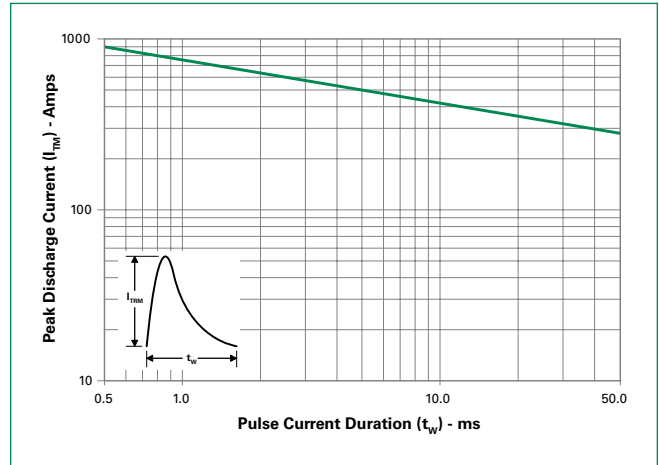

**Figure 9: Peak Capacitor Discharge Current Derating**

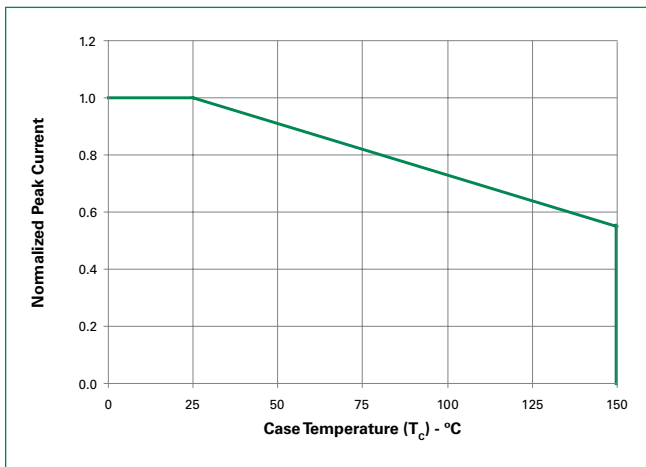

**Figure 10: Surge Peak On-State Current vs. Number of Cycles**

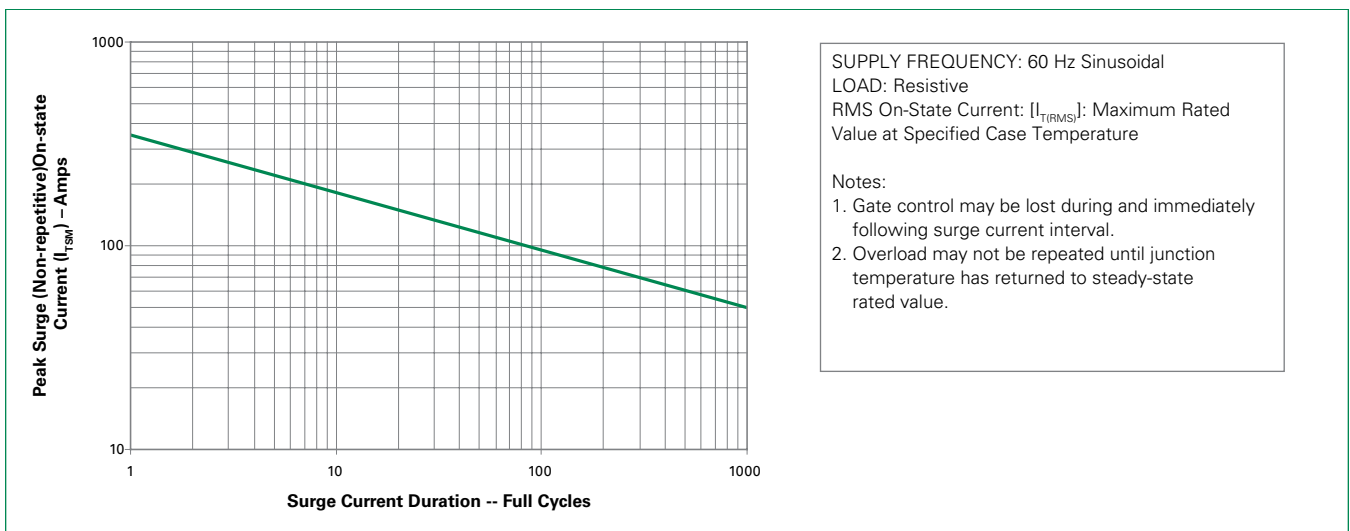

# SVxx20xxQ Series

## 20 Amp High Junction Temperature SCRs

### Soldering Parameters

<b>Reflow Condition</b>		Pb – Free assembly
<b>Pre Heat</b>	- Temperature Min ( $T_{s(min)}$ )	150°C
	- Temperature Max ( $T_{s(max)}$ )	200°C
	- Time (min to max) ( $t_s$ )	60 – 180 secs
<b>Average ramp up rate (Liquidus Temp) (<math>T_L</math>) to peak</b>		5°C/second max
<b><math>T_{s(max)}</math> to <math>T_L</math> - Ramp-up Rate</b>		5°C/second max
<b>Reflow</b>	- Temperature ( $T_L$ ) (Liquidus)	217°C
	- Time ( $t_L$ )	60 – 150 seconds
<b>Peak Temperature (<math>T_p</math>)</b>		260 <sup>+0/-5</sup> °C
<b>Time within 5°C of actual peak Temperature (<math>t_p</math>)</b>		20 – 40 seconds
<b>Ramp-down Rate</b>		5°C/second max
<b>Time 25°C to peak Temperature (<math>T_p</math>)</b>		8 minutes Max.
<b>Do not exceed</b>		280°C

### Physical Specifications

<b>Terminal Finish</b>	100% Matte Tin-plated
<b>Body Material</b>	UL Recognized compound meeting flammability rating V-0
<b>Lead Material</b>	Copper Alloy

### Design Considerations

Careful selection of the correct component for the application's operating parameters and environment will go a long way toward extending the operating life of the Thyristor. Good design practice should limit the maximum continuous current through the main terminals to 75% of the component rating. Other ways to ensure long life for a power discrete semiconductor are proper heat sinking and selection of voltage ratings for worst case conditions. Overheating, overvoltage (including  $dv/dt$ ), and surge currents are the main killers of semiconductors. Correct mounting, soldering, and forming of the leads also help protect against component damage.

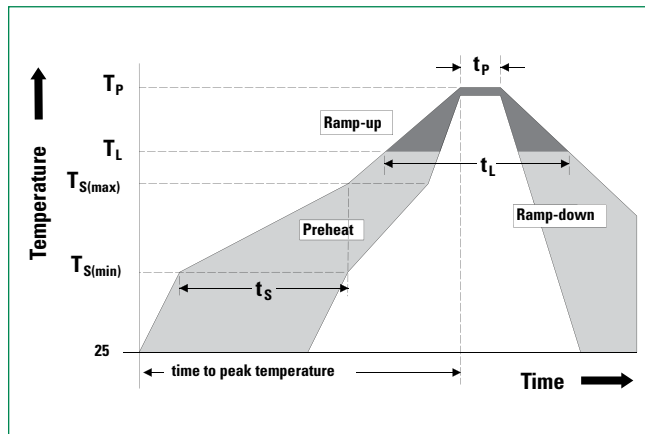

### Environmental Specifications

Test	Specifications and Conditions
<b>AC Blocking</b>	MIL-STD-750, M-1040, Cond A Applied Peak AC voltage @ 150°C for 1008 hours
<b>Temperature Cycling</b>	MIL-STD-750, M-1051, 1000 cycles; -55°C to +150°C; 15-min dwell-time
<b>Temperature/Humidity</b>	EIA / JEDEC, JESD22-A101 1008 hours; 160V - DC: 85°C; 85% rel humidity
<b>Resistance to Solder Heat</b>	MIL-STD-750 Method 2031
<b>Solderability</b>	ANSI/J-STD-002, category 3, Test A
<b>Lead Bend</b>	MIL-STD-750, M-2036 Cond E
<b>Moisture Sensitivity Level</b>	Level 1, JEDEC-J-STD-020D

# SVxx20xxQ Series

## 20 Amp High Junction Temperature SCRs

### Dimensions – TO-220AB (L-Package) – Isolated Mounting Tab

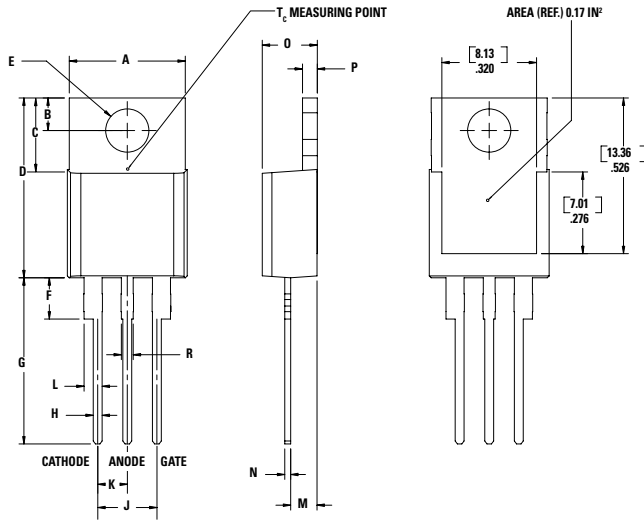

Dimension	Inches		Millimeters	
	Min	Max	Min	Max
A	0.380	0.420	9.65	10.67
B	0.105	0.115	2.67	2.92
C	0.230	0.250	5.84	6.35
D	0.590	0.620	14.99	15.75
E	0.142	0.147	3.61	3.73
F	0.110	0.130	2.79	3.30
G	0.540	0.575	13.72	14.61
H	0.025	0.035	0.64	0.89
J	0.195	0.205	4.95	5.21
K	0.095	0.105	2.41	2.67
L	0.060	0.075	1.52	1.91
M	0.085	0.095	2.16	2.41
N	0.018	0.024	0.46	0.61
O	0.178	0.188	4.52	4.78
P	0.045	0.060	1.14	1.52
R	0.038	0.048	0.97	1.22

### Dimensions – TO-220AB (R-Package) – Non-Isolated Mounting Tab Common with Center Lead

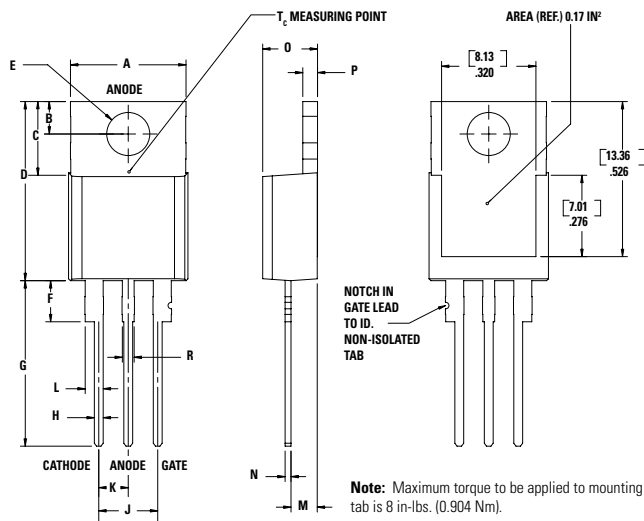

Dimension	Inches		Millimeters	
	Min	Max	Min	Max
A	0.380	0.420	9.65	10.67
B	0.105	0.115	2.67	2.92
C	0.230	0.250	5.84	6.35
D	0.590	0.620	14.99	15.75
E	0.142	0.147	3.61	3.73
F	0.110	0.130	2.79	3.30
G	0.540	0.575	13.72	14.61
H	0.025	0.035	0.64	0.89
J	0.195	0.205	4.95	5.21
K	0.095	0.105	2.41	2.67
L	0.060	0.075	1.52	1.91
M	0.085	0.095	2.16	2.41
N	0.018	0.024	0.46	0.61
O	0.178	0.188	4.52	4.78
P	0.045	0.060	1.14	1.52
R	0.038	0.048	0.97	1.22

# SVxx20xxQ Series

## 20 Amp High Junction Temperature SCRs

### Dimensions – TO- 263AB (N-package) – D2-Pak Surface Mount

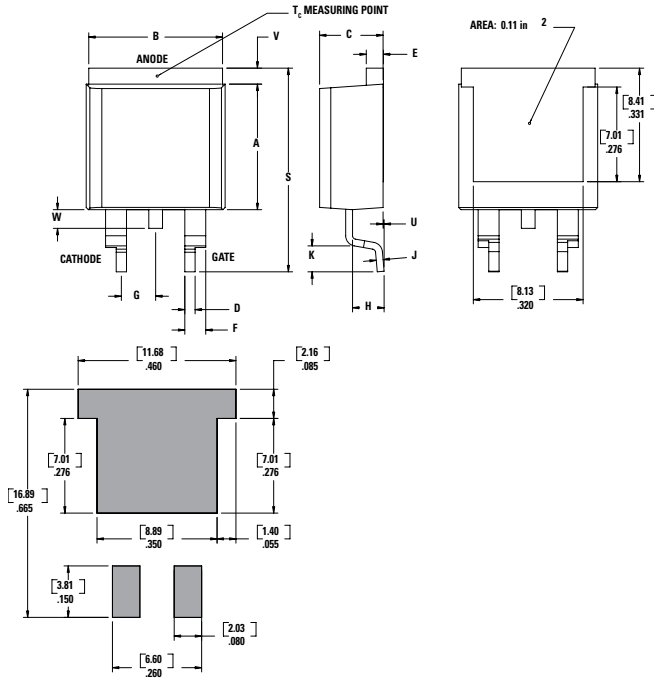

Dimension	Inches		Millimeters	
	Min	Max	Min	Max
A	0.360	0.370	9.14	9.40
B	0.380	0.420	9.65	10.67
C	0.178	0.188	4.52	4.78
D	0.025	0.035	0.64	0.89
E	0.045	0.060	1.14	1.52
F	0.060	0.075	1.52	1.91
G	0.095	0.105	2.41	2.67
H	0.092	0.102	2.34	2.59
J	0.018	0.024	0.46	0.61
K	0.090	0.110	2.29	2.79
S	0.590	0.625	14.99	15.88
V	0.035	0.045	0.89	1.14
U	0.002	0.010	0.05	0.25
W	0.040	0.070	1.02	1.78

### Product Selector

Part Number	Voltage	Gate Sensitivity	Type	Package
	600V			
SVxx20L1Q	X	6mA	Standard SCR	TO-220L
SVxx20R1Q	X	6mA	Standard SCR	TO-220R
SVxx20N1Q	X	6mA	Standard SCR	TO-263
SVxx20L2Q	X	10mA	Standard SCR	TO-220L
SVxx20R2Q	X	10mA	Standard SCR	TO-220R
SVxx20N2Q	X	10mA	Standard SCR	TO-263

Note: xx = Voltage/10

### Packing Options

Part Number	Marking	Weight	Packing Mode	Base Quantity
SVxx20LxQTP	SVxx20LxQ	2.2g	Tube	1000 (50 per tube)
SVxx20RxQTP	SVxx20RxQ	2.2g	Tube	1000 (50 per tube)
SVxx20NxQTP	SVxx20NxQ	1.6g	Tube	1000 (50 per tube)
SVxx20NxQRP	SVxx20NxQ	1.6g	Embossed Carrier	500

Note: xx=voltage/10, x=sensitivity

# SVxx20xxQ Series

## 20 Amp High Junction Temperature SCRs

### Part Numbering System

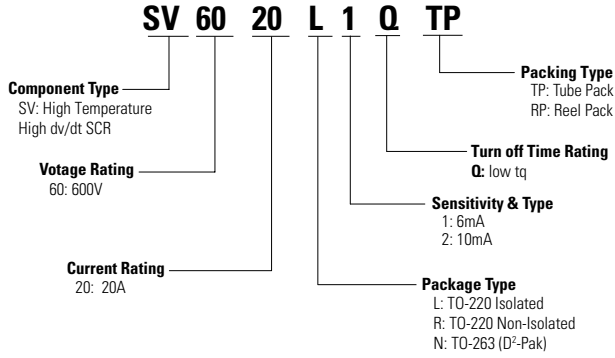

### Part Marking System

T0-220 AB - (L and R Package)  
T0-263 AB - (N Package)



**Date Code Marking**  
**Y**: Year Code  
**M**: Month Code  
**XXX**: Lot Trace Code

### TO-263 Embossed Carrier Reel Pack (RP) Specifications

Meets all EIA-481-2 Standards

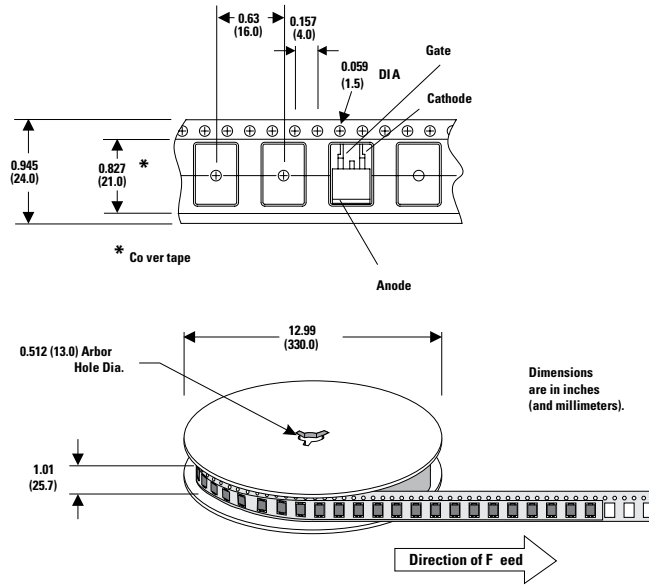

**Disclaimer Notice** - Information furnished is believed to be accurate and reliable. However, users should independently evaluate the suitability of and test each product selected for their own applications. Littelfuse products are not designed for, and may not be used in, all applications. Read complete Disclaimer Notice at <http://www.littelfuse.com/disclaimer-electronics>.