

# SVxx12xx series

## 12 Amp High Junction Temperature SCRs

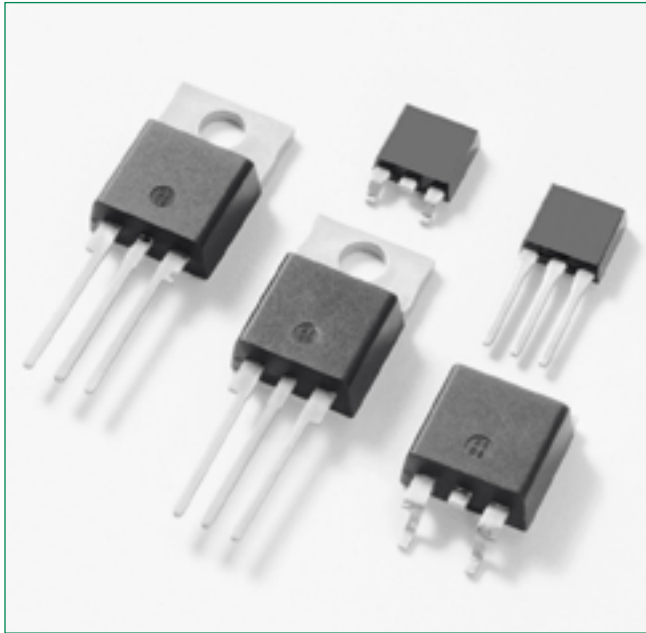

### Description

The SVxx12xx high junction temperature SCR series is ideal for uni-directional switch applications such as phase control in heating, motor speed controls, converters/rectifiers, inrush current control and capacitive discharge ignitions.

These SCRs have a low gate current, (IGT) trigger level of 6mA and 10mA maximum at approximately 1.5V for SVxx12x1 and SVxx12x2, respectively.

### Features & Benefits

- Halogen free and RoHS compliant
- 150°C maximum junction temperature
- Surge capability up to 120A at 60Hz half cycle
- High dv/dt performance
- Recognized to UL 1557 as an Electrically Semiconductor Device

### Applications

Typical applications include AC Generator (ACG) rectifiers, battery voltage regulators and generic converters and inrush current controller in various AC to DC applications. Additional applications include controls for power tools, home/brown good and white goods appliances.

Internally constructed isolated packages offered for ease of heat sinking with high isolation voltage.

### Agency Approval

Agency	Agency File Number
	E71639*

\*L Packages only

### Main Features

Symbol	Value	Unit
$I_{T(RMS)}$	12	A
$V_{DRM}/V_{RRM}$	600 to 800	V
$I_{GT}$	6 to 20	mA

### Schematic Symbol

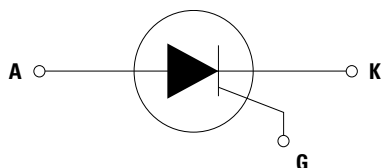

# SVxx12xx series

## 12 Amp High Junction Temperature SCRs

### Absolute Maximum Ratings

Symbol	Parameter	Test Conditions	Value	Unit
$V_{DSM}/V_{RSM}$	Peak non-repetitive blocking voltage	$P_W = 100 \mu s, V_{xRM} = 600 V$	$V_{DRM}/V_{RRM} + 100$	V
		$P_W = 100 \mu s, V_{xRM} = 800 V$	$V_{DRM}/V_{RRM} + 200$	
$I_{T(RMS)}$	RMS on-state current	SVxx12Lx $T_C = 110^\circ C$	12	A
		SVxx12Rx/ SVxx12Nx $T_C = 135^\circ C$		
		SVxx12D $T_C = 130^\circ C$		
$I_{T(AV)}$	Average on-state current	SVxx12Lx $T_C = 110^\circ C$	7.6	A
		SVxx12Rx/ SVxx12Nx $T_C = 135^\circ C$		
		SVxx12D $T_C = 130^\circ C$		
$I_{TSM}$	Peak non-repetitive surge current (single half cycle, $T_J$ (initial) = $25^\circ C$ )	SVxx12Lx/ SVxx12Rx/ SVxx12Nx $f = 50 Hz$	100	A
		SVxx12D $f = 50 Hz$	120	
		SVxx12Lx/ SVxx12Rx/ SVxx12Nx $f = 60 Hz$	120	
		SVxx12D $f = 60 Hz$	144	
$I^2t$	$I^2t$ Value for fusing	SVxx12Lx/ SVxx12Rx/ SVxx12Nx $t_p = 8.3 ms$	60	A <sup>2</sup> s
		SVxx12D $t_p = 8.3 ms$	86	
di/dt	Critical rate of rise of on-state current	$f = 60 Hz; T_J = 150^\circ C$	100	A/ $\mu s$
$I_{GM}$	Peak gate current	SVxx12Lx/ SVxx12Rx/ SVxx12Nx $T_J = 150^\circ C$	4	A
		SVxx12D $T_J = 150^\circ C$	2	
$P_{G(AV)}$	Average gate power dissipation	SVxx12Lx/ SVxx12Rx/ SVxx12Nx $T_J = 150^\circ C$	0.8	W
		SVxx12D $T_J = 150^\circ C$	0.5	
$T_{stg}$	Storage temperature range	–	-40 to 150	$^\circ C$
$T_J$	Operating junction temperature range	–	-40 to 150	$^\circ C$

Note: xx=voltage/10, x=sensitivity

### Electrical Characteristics ( $T_J = 25^\circ C$ , unless otherwise specified)

Symbol	Test Conditions		SVxx12x1	SVxx12x2	SVxx12x	Unit
$I_{GT}$	$V_D = 12V, R_L = 60 \Omega$	MAX.	6	10	20	mA
		MIN.	2	5	1	
$V_{GT}$	$V_D = 12V, R_L = 60 \Omega$	MAX.	–	–	1.3	mA
dv/dt	$V_D = 67\% V_{DRM}$ ; gate open; $T_J = 125^\circ C$	MIN.	400	800	–	V/ $\mu s$
	$V_D = 67\% V_{DRM}$ ; gate open; $T_J = 150^\circ C$		200	400	–	
dv/dt	$V_D = V_{DRM}$ ; gate open; $T_J = 125^\circ C$	MIN.	–	–	200	V/ $\mu s$
	$V_D = V_{DRM}$ ; gate open; $T_J = 150^\circ C$		–	–	150	
$V_{GD}$	$V_D = V_{DRM}, R_L = 3.3 k\Omega, T_J = 150^\circ C$	MIN.	0.2	0.2	0.2	V
$I_H$	$I_T = 200 mA$ (initial)	MAX.	22	35	40	mA
$t_q$	$I_T = 2A; t_p = 50 \mu s; dv/dt = 5V/\mu s; di/dt = 30A/\mu s$	MAX.	25	25	35	$\mu s$
$t_{gt}$	$I_G = 2 \times I_{GT}, P_W = 15 \mu s, I_T = 24A$	TYP.	2.6	2.6	1	$\mu s$
$V_{TO}$	$T_J = 150^\circ C$	MAX.	–	–	0.8	V
$R_D$	$T_J = 150^\circ C$	MAX.	–	–	30	m $\Omega$

Note: xx=voltage/10, x=package

# SVxx12xx series

## 12 Amp High Junction Temperature SCRs

### Static Characteristics

Symbol	Test Conditions		Value	Unit	
$V_{TM}$	$I_T = 24A; t_p = 380 \mu s$		MAX.	1.6	V
$I_{DRM} / I_{RRM}$	$T_J = 25^\circ C$	$V_{DRM} = V_{RRM}$	MAX.	5	$\mu A$
	$T_J = 125^\circ C$	$V_{DRM} = V_{RRM} = 600V$		0.5	mA
		$V_{DRM} = V_{RRM} = 800V$		1	
	$T_J = 150^\circ C$	$V_{DRM} = V_{RRM}$		2	mA

### Thermal Resistances

Symbol	Parameter		Value	Unit
$R_{\theta(jc)}$	Junction to case (AC)	SVxx12Lx	2.5	$^\circ C/W$
		SVxx12Rx/ SVxx12Nx	1.1	
		SVxx12Dx	1.5	

Note: xx=voltage/10, x=package

# SVxx12xx series

## 12 Amp High Junction Temperature SCRs

**Figure 1:** Normalized DC Gate Trigger Current vs. Junction Temperature

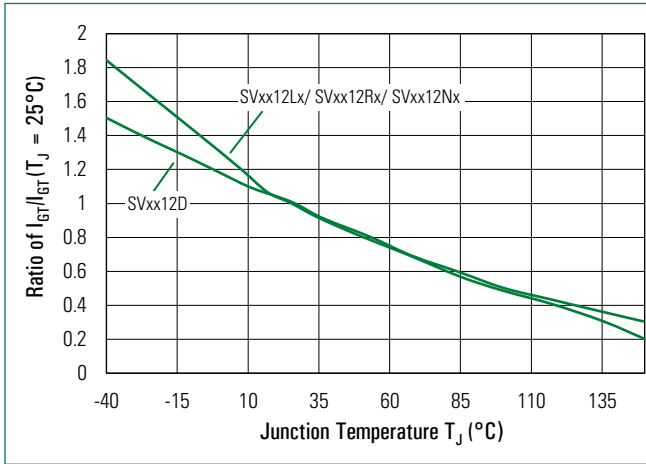

**Figure 2:** Normalized DC Gate Trigger Voltage vs. Junction Temperature

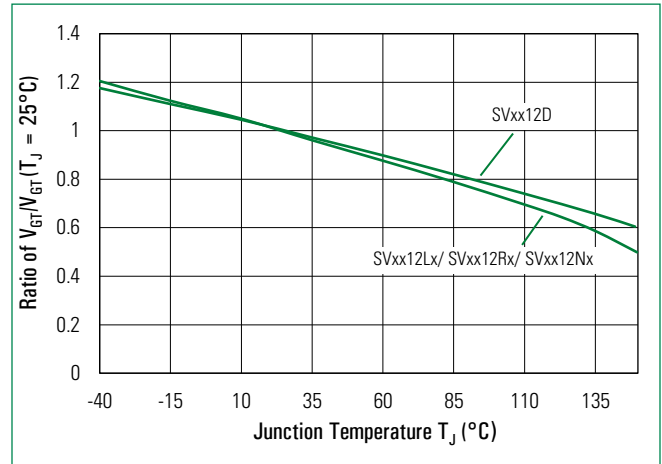

**Figure 3:** Normalized DC Holding Current vs. Junction Temperature

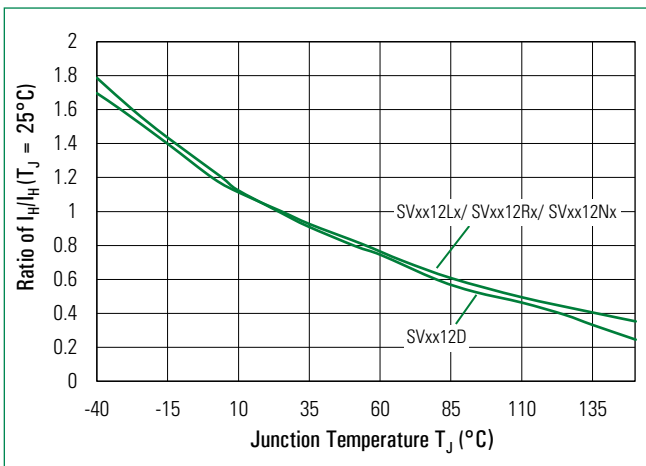

**Figure 4:** On-State Current vs. On-State Voltage (Typical)

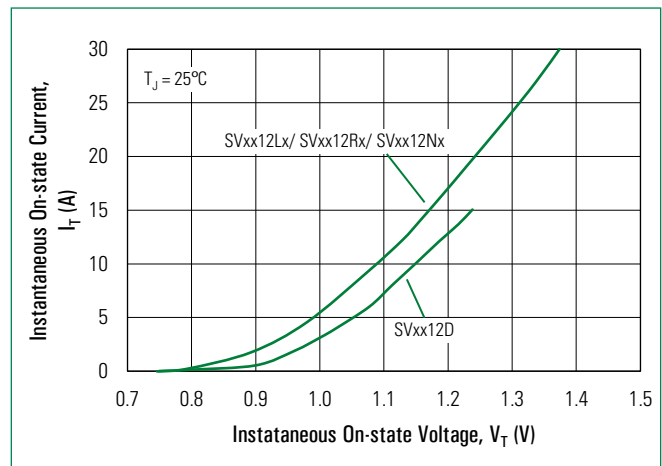

**Figure 5:** Power Dissipation (Typical) vs. RMS On-State Current

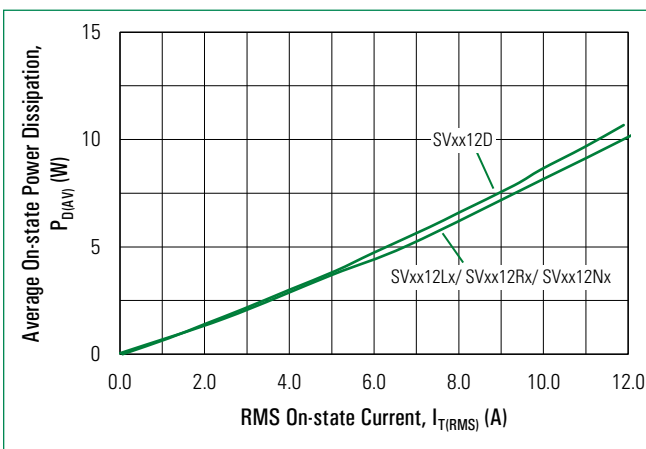

**Figure 6:** Maximum Allowable Case Temperature vs. RMS On-State Current

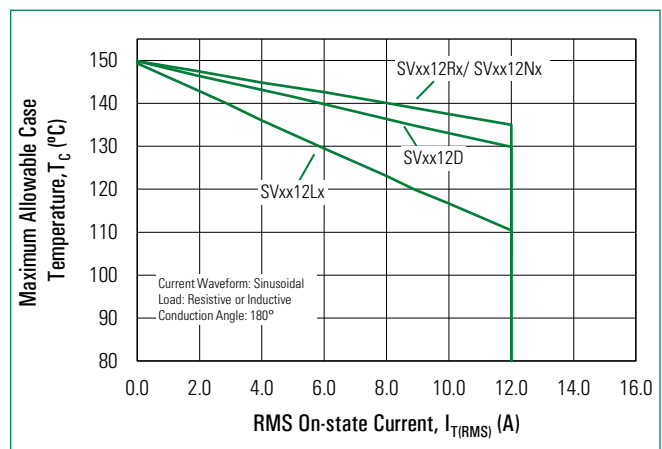

# SVxx12xx series

## 12 Amp High Junction Temperature SCRs

**Figure 7:** Maximum Allowable Case Temperature vs. Average On-State Current

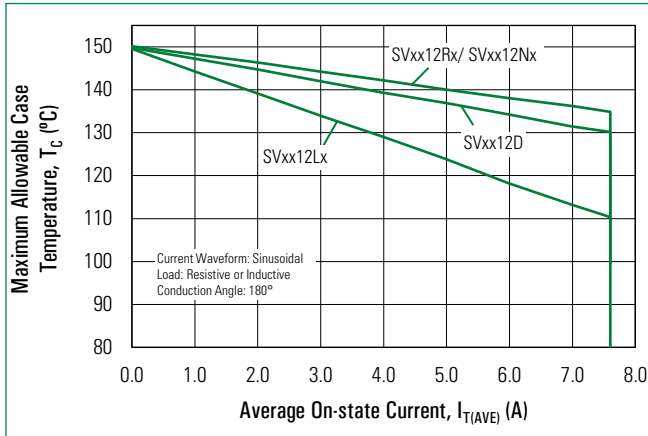

**Figure 8:** Peak Capacitor Discharge Current

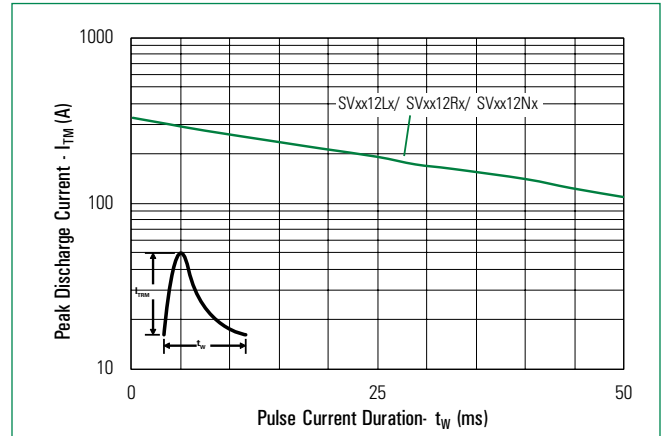

**Figure 9:** Peak Capacitor Discharge Current Derating

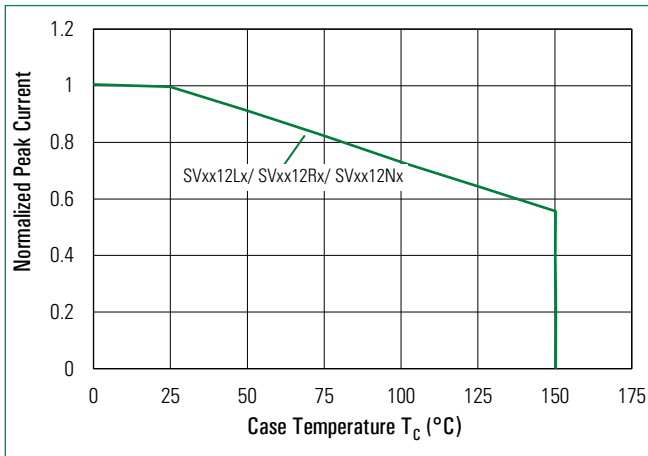

**Figure 10:** Surge Peak On-State Current vs. Number of Cycles

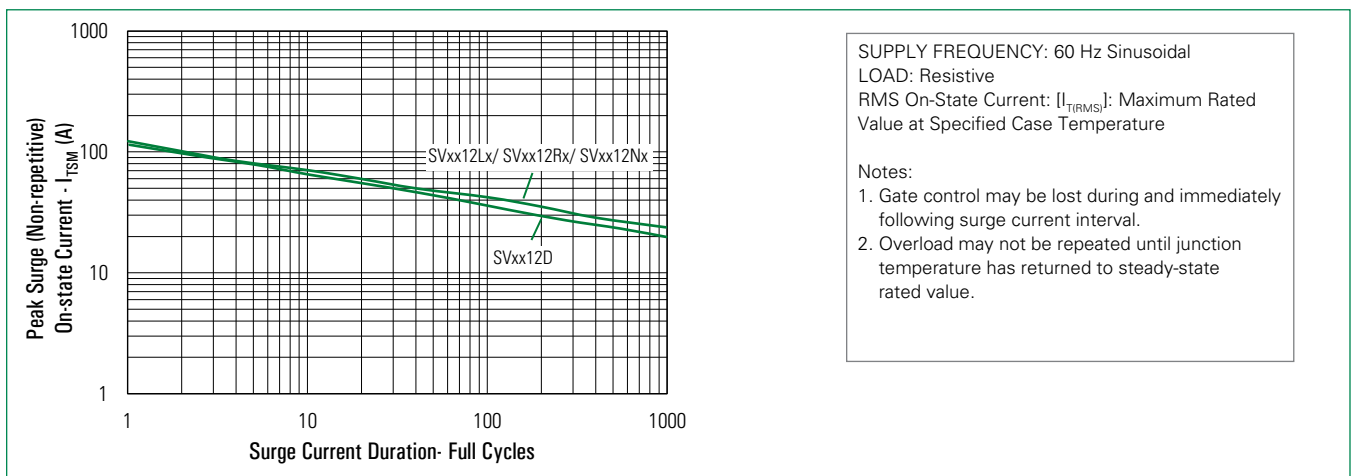

# SVxx12xx series

## 12 Amp High Junction Temperature SCRs

### Soldering Parameters

<b>Reflow Condition</b>		Pb – Free assembly
<b>Pre Heat</b>	- Temperature Min ( $T_{s(min)}$ )	150°C
	- Temperature Max ( $T_{s(max)}$ )	200°C
	- Time (min to max) ( $t_s$ )	60 – 180 secs
<b>Average ramp up rate (Liquidus Temp) (<math>T_L</math>) to peak</b>		5°C/second max
<b><math>T_{s(max)}</math> to <math>T_L</math> - Ramp-up Rate</b>		5°C/second max
<b>Reflow</b>	- Temperature ( $T_L$ ) (Liquidus)	217°C
	- Time ( $t_l$ )	60 – 150 seconds
<b>Peak Temperature (<math>T_p</math>)</b>		260 <sup>+0/-5</sup> °C
<b>Time within 5°C of actual peak Temperature (<math>t_p</math>)</b>		20 – 40 seconds
<b>Ramp-down Rate</b>		5°C/second max
<b>Time 25°C to peak Temperature (<math>T_p</math>)</b>		8 minutes Max.
<b>Do not exceed</b>		280°C

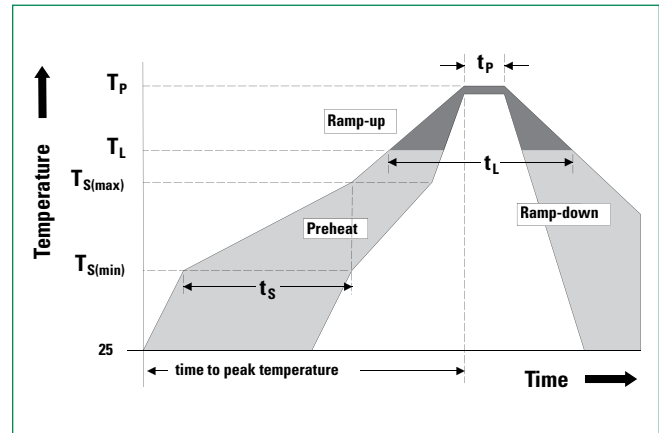

### Physical Specifications

<b>Terminal Finish</b>	100% Matte Tin-plated
<b>Body Material</b>	UL Recognized compound meeting flammability rating V-0
<b>Lead Material</b>	Copper Alloy

### Design Considerations

Careful selection of the correct component for the application's operating parameters and environment will go a long way toward extending the operating life of the Thyristor. Good design practice should limit the maximum continuous current through the main terminals to 75% of the component rating. Other ways to ensure long life for a power discrete semiconductor are proper heat sinking and selection of voltage ratings for worst case conditions. Overheating, overvoltage (including  $dv/dt$ ), and surge currents are the main killers of semiconductors. Correct mounting, soldering, and forming of the leads also help protect against component damage.

### Environmental Specifications

Test	Specifications and Conditions
<b>AC Blocking</b>	MIL-STD-750, M-1040, Cond A Applied Peak AC voltage @ 150°C for 1008 hours
<b>Temperature Cycling</b>	MIL-STD-750, M-1051, 1000 cycles; -55°C to +150°C; 15-min dwell-time
<b>Temperature/Humidity</b>	EIA / JEDEC, JESD22-A101 1008 hours; 160V - DC: 85°C; 85% rel humidity
<b>Resistance to Solder Heat</b>	MIL-STD-750 Method 2031
<b>Solderability</b>	ANSI/J-STD-002, category 3, Test A
<b>Lead Bend</b>	MIL-STD-750, M-2036 Cond E
<b>Moisture Sensitivity Level</b>	Level 1, JEDEC-J-STD-020D

# SVxx12xx series

## 12 Amp High Junction Temperature SCRs

### Dimensions – TO-220AB (L-Package) – Isolated Mounting Tab

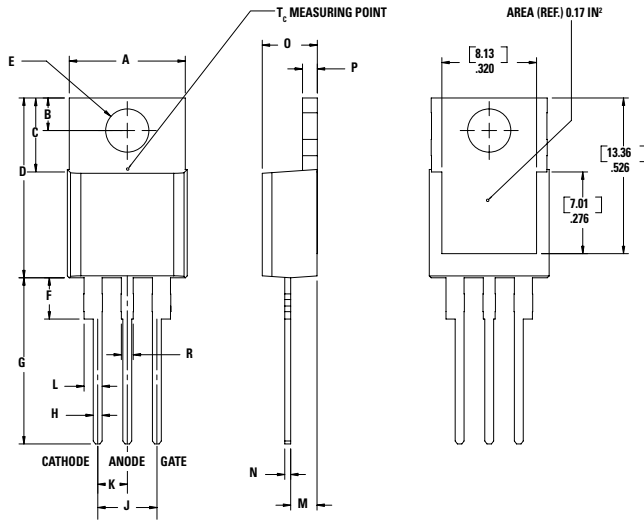

Dimension	Inches		Millimeters	
	Min	Max	Min	Max
A	0.380	0.420	9.65	10.67
B	0.105	0.115	2.67	2.92
C	0.230	0.250	5.84	6.35
D	0.590	0.620	14.99	15.75
E	0.142	0.147	3.61	3.73
F	0.110	0.130	2.79	3.30
G	0.540	0.575	13.72	14.61
H	0.025	0.035	0.64	0.89
J	0.195	0.205	4.95	5.21
K	0.095	0.105	2.41	2.67
L	0.060	0.075	1.52	1.91
M	0.085	0.095	2.16	2.41
N	0.018	0.024	0.46	0.61
O	0.178	0.188	4.52	4.78
P	0.045	0.060	1.14	1.52
R	0.038	0.048	0.97	1.22

### Dimensions – TO-220AB (R-Package) – Non-Isolated Mounting Tab Common with Center Lead

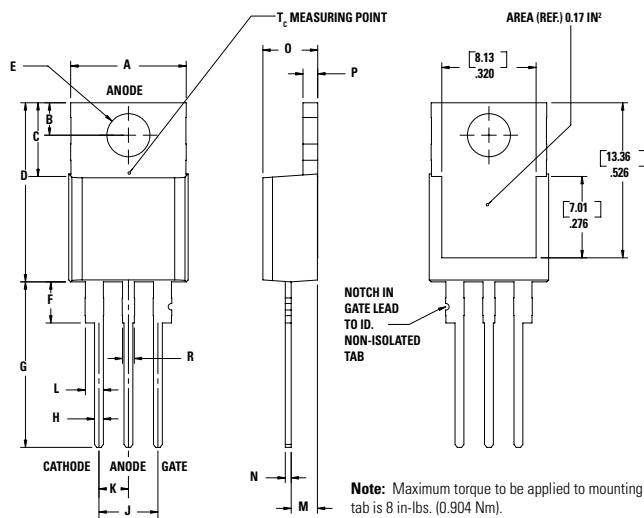

Dimension	Inches		Millimeters	
	Min	Max	Min	Max
A	0.380	0.420	9.65	10.67
B	0.105	0.115	2.67	2.92
C	0.230	0.250	5.84	6.35
D	0.590	0.620	14.99	15.75
E	0.142	0.147	3.61	3.73
F	0.110	0.130	2.79	3.30
G	0.540	0.575	13.72	14.61
H	0.025	0.035	0.64	0.89
J	0.195	0.205	4.95	5.21
K	0.095	0.105	2.41	2.67
L	0.060	0.075	1.52	1.91
M	0.085	0.095	2.16	2.41
N	0.018	0.024	0.46	0.61
O	0.178	0.188	4.52	4.78
P	0.045	0.060	1.14	1.52
R	0.038	0.048	0.97	1.22

# SVxx12xx series

## 12 Amp High Junction Temperature SCRs

### Dimensions — TO- 252AA (D-package) — D-Pak Surface Mount

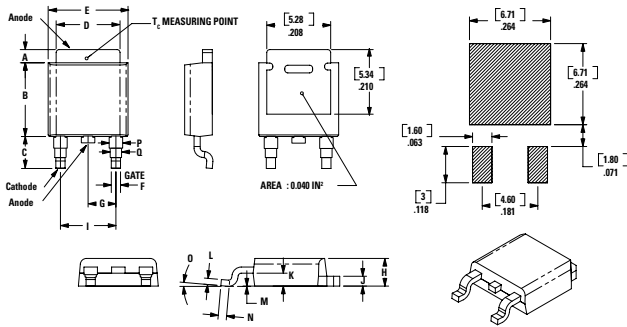

Dimension	Inches			Millimeters		
	Min	Typ	Max	Min	Typ	Max
A	0.040	0.043	0.050	1.02	1.09	1.27
B	0.235	0.243	0.245	5.97	6.16	6.22
C	0.106	0.108	0.113	2.69	2.74	2.87
D	0.205	0.208	0.213	5.21	5.29	5.41
E	0.255	0.262	0.265	6.48	6.65	6.73
F	0.027	0.031	0.033	0.69	0.80	0.84
G	0.087	0.090	0.093	2.21	2.28	2.36
H	0.085	0.092	0.095	2.16	2.33	2.41
I	0.176	0.179	0.184	4.47	4.55	4.67
J	0.018	0.020	0.023	0.46	0.51	0.58
K	0.038	0.040	0.044	0.97	1.02	1.12
L	0.018	0.020	0.023	0.46	0.51	0.58
M	0.000	0.000	0.004	0.00	0.00	0.10
N	0.021	0.026	0.027	0.53	0.67	0.69
O	0°	0°	5°	0°	0°	5°
P	0.042	0.047	0.052	1.06	1.20	1.32
Q	0.034	0.039	0.044	0.86	1.00	1.11

### Dimensions — TO- 263AB (N-package) — D2-Pak Surface Mount

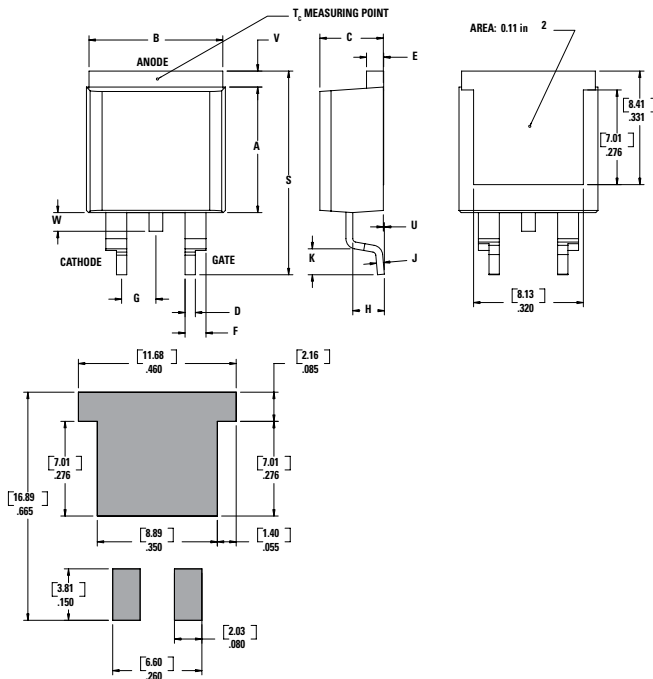

Dimension	Inches		Millimeters	
	Min	Max	Min	Max
A	0.360	0.370	9.14	9.40
B	0.380	0.420	9.65	10.67
C	0.178	0.188	4.52	4.78
D	0.025	0.035	0.64	0.89
E	0.045	0.060	1.14	1.52
F	0.060	0.075	1.52	1.91
G	0.095	0.105	2.41	2.67
H	0.092	0.102	2.34	2.59
J	0.018	0.024	0.46	0.61
K	0.090	0.110	2.29	2.79
S	0.590	0.625	14.99	15.88
V	0.035	0.045	0.89	1.14
U	0.002	0.010	0.05	0.25
W	0.040	0.070	1.02	1.78



# SVxx12xx series

## 12 Amp High Junction Temperature SCRs

### Product Selector

Part Number	Voltage		Gate Sensitivity	Type	Package
	600V	800V			
SVxx12L1	X	–	6mA	Standard SCR	TO-220L
SVxx12R1	X	–	6mA	Standard SCR	TO-220R
SVxx12N1	X	–	6mA	Standard SCR	TO-263
SVxx12L2	X	–	10mA	Standard SCR	TO-220L
SVxx12R2	X	–	10mA	Standard SCR	TO-220R
SVxx12N2	X	–	10mA	Standard SCR	TO-263
SVxx12D	–	X	20mA	Standard SCR	TO-252

Note: xx = Voltage/10

### Packing Options

Part Number	Marking	Weight	Packing Mode	Base Quantity
SVxx12LxTP	SVxx12Ly	2.2g	Tube	1000 (50 per tube)
SVxx12RxTP	SVxx12Ry	2.2g	Tube	1000 (50 per tube)
SVxx12NxTP	SVxx12Ny	1.6g	Tube	1000 (50 per tube)
SVxx12NxRP	SVxx12Ny	1.6g	Embossed Carrier	500
SVxx12DTP	SVxx12D	0.3g	Tube	750 (75 per tube)
SVxx12DRP	SVxx12D	0.3g	Embossed Carrier	2500

Note: xx=voltage/10, x=sensitivity

# SVxx12xx series

## 12 Amp High Junction Temperature SCRs

### Part Numbering System

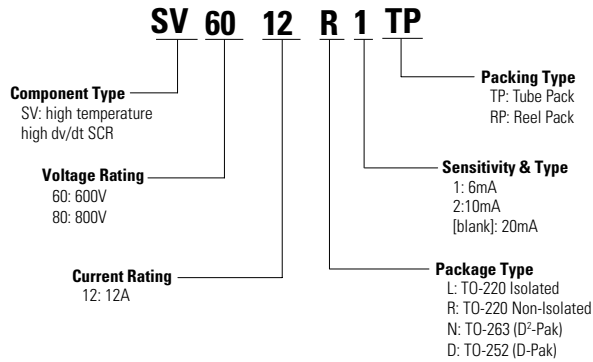

### Part Marking System

TO-220 AB - (L and R Package)  
TO-263 - (N Package)

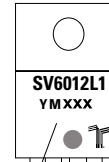

**Date Code Marking**  
Y: Year Code  
M: Month Code  
XXX: Lot Trace Code

TO-252 (D-Pak)

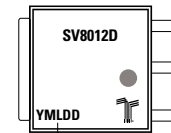

**Date Code Marking**  
Y: Year Code  
M: Month Code  
L: Location Code  
DD: Calendar Code

### TO-263 Embossed Carrier Reel Pack (RP) Specifications

Meets all EIA-481-2 Standards

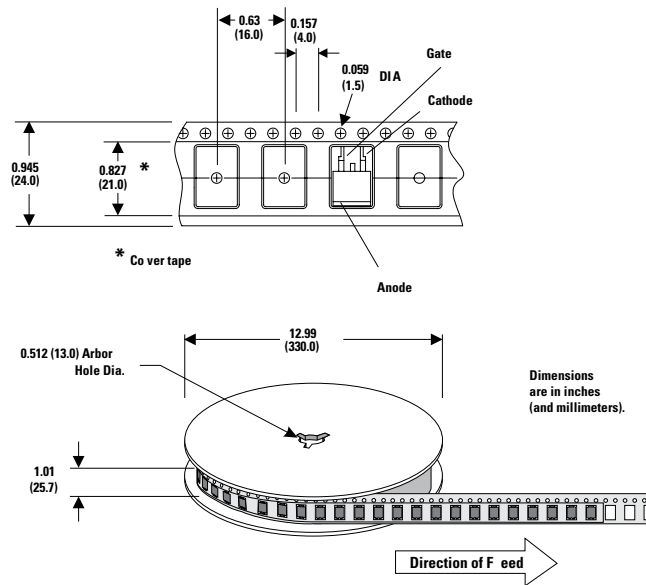

**Disclaimer Notice** - Information furnished is believed to be accurate and reliable. However, users should independently evaluate the suitability of and test each product selected for their own applications. Littelfuse products are not designed for, and may not be used in, all applications. Read complete Disclaimer Notice at <http://www.littelfuse.com/disclaimer-electronics>.