

PCN11 Series (Product Compliant with DIN Standard: Solderless Connection Type)

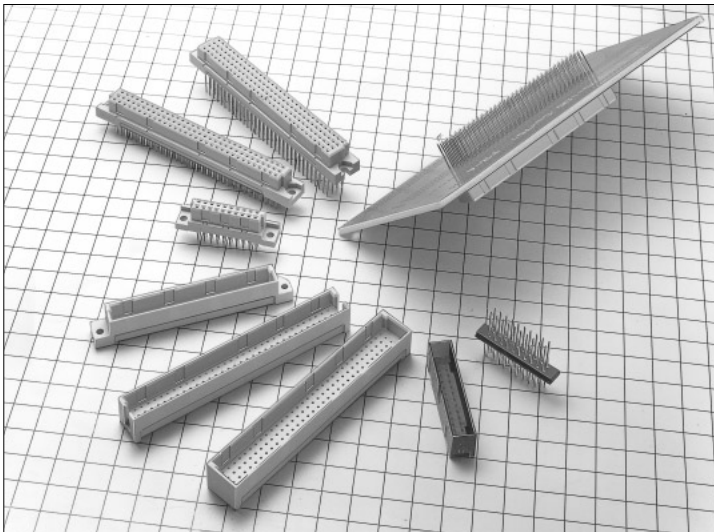

■ Features

1. Compliant with the DIN standard

Comply with IEC603-2/DIN41612 standards.

2. Variation in number of contacts

10, 16, 20, 32, 44, 50, 64, 90, 96, 100 and 128 contacts are available.

3. Reliability contact construction

The socket contact is constructed with the high reliability double-sided 2-point contacts.

4. Applicable contact board thickness

The applicable contact board thickness is 2.54mm min.

5. Through-hole diameter variation

ϕ 0.8, ϕ 0.9 and ϕ 1.0 through holes are available.

6. Backplane connection

Connected to the Backplane.

Refer to the fig 1

7. Compatibility with other series

Compatibility with PCN10, 12, and 13 series allows to utilize various application patterns.

8. Press fit machine

Press fit machine is available.

■ Application

PBX, control equipment and so on.

Backplane Connection

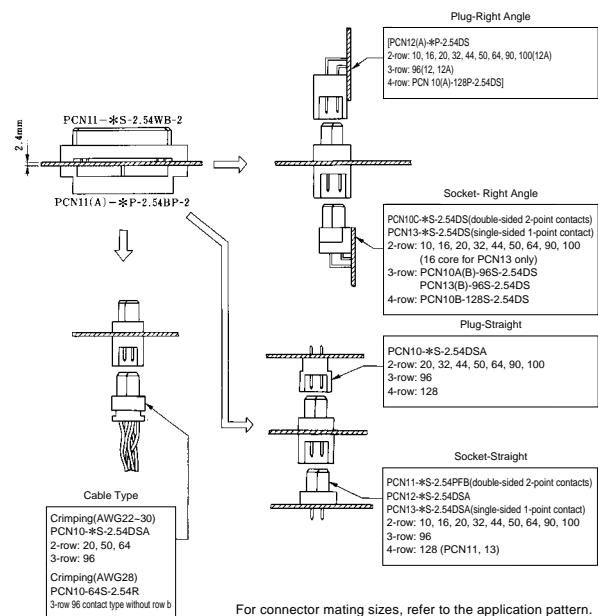

Fig 1

Press fit Machine



■Product Specifications

Rating	Current rating: 2A Voltage rating: 300V AC	Operating Temperature Range: -30 to +85°C (Note 1) Operating Humidity Range: 40 to 80%	Storage Temperature Range: -10 to +60°C (Note 2) Operating Humidity Range: 40 to 70% (Note 2)
--------	---	---	--

Item	Specification	Condition
1.Insulation Resistance	10 ⁹ M ohms	100V DC
2.Withstanding Voltage	No flashover or insulation breakdown.	1000V AC/1 minute.
3.Contact Resistance	20m ohms max.	0.1A
4.Vibration	No electrical discontinuity of 10 μ s or more	Frequency: 10 to 55 Hz, single amplitude of 0.75 mm, 2 hours in each of the 3 directions.
5.Humidity (Steady state)	Insulation resistance : 10 ⁹ M ohms min.	96 hours at temperature of 40°C and humidity of 90% to 95%
6.Temperature Cycle	No damage, cracks, or parts looseness.	(-65°C : 30 minutes → 15 to 35°C: 5 minutes max. → 125°C : 30 minutes → 15 to 35°C: 5 minutes max.) 5 cycles
7.Durability (Mating/un-mating)	Contact resistance : 20m ohms max.	500 cycles
8.Resistance to Soldering heat	No deformation of components affecting performance.	Manual soldering: 300°C for 3 seconds

Note 1: Includes temperature rise caused by current flow.

Note 2: The term "storage" refers to products stored for long period of time prior to mounting and use. Operating Temperature Range and Humidity range covers non conducting condition of installed connectors in storage, shipment or during transportation.

■ Material

●Housing, Contact Board and Key Header

Parts	Material	Finish	Remarks
Insulator	PBT		
Contact	Copper alloy	Contact area: Gold plated Remainder: Gold plated	—

●Receptacle, Backplane Housing

Parts	Material	Finish	Remarks
Insulator	PBT	Beige	UL94V-0
Contact	Copper alloy	PFB Contact area: Gold plated Remainder: Tin-lead plated WB Contact area: Gold plated Remainder: Gold flash plated Post area: Gold plated	—

■Ordering Information

●Housing

PCN11 A - * P - 2.54 H 2
 ① ② ③ ④ ⑤ ⑥ ⑦

① Series name	: PCN11
② Mounting hole type	Blank : With Mounting hole A : Without mounting hole
③ Number of contacts	: 20, 32, 44, 50, 64, 90, 96, 100
④ Opening type	P : Male connector
⑤ Contact pitch	: 2.54mm
⑥ H : Housing	
⑦ Board thickness	2 : 2.4mm

●Contact Board

PCN11 - * P - 2.54 WA - 2
 ① ② ③ ④ ⑤ ⑥

① Series name	: PCN11
② Number of contacts	: 20, 32, 44, 50, 64, 90, 96, 100
③ Opening type	P : Male connector
④ Contact pitch	: 2.54mm
⑤ Contact type	WA : Wrapping Backplane (Dia.0.8) WB : Wrapping Backplane (Dia.0.9) WC : Wrapping Backplane (Dia.1.0)
⑥ Board thickness	2 : 2.4mm

●Key Header (Correspond to Backplane system)

PCN11 - * P - 2.54 KH
 ① ② ③ ④ ⑤

① Series name	: PCN11
② Number of contacts	: 10, 14, 16, 20, 26, 30, 34, 40, 50, 64, 96
③ Opening type	P : Male connector
④ Contact pitch	: 2.54mm
⑤ KH : Key header	

●Receptacle

PCN11 - * S - 2.54 PFB - 2
 ① ② ③ ④ ⑤ ⑥

① Series name	: PCN11
② Number of contacts	: 10, 16, 20, 32, 44, 50, 64, 90, 96, 100, 128
③ Opening type	S : Female connector
④ Contact pitch	: 2.54mm
⑤ Contact type	PFB : Short type (Dia.0.9) WB : Wrapping Backplane (Dia.0.9)
⑥ Board thickness	2 : 2.4mm

●Backplane Housing

PCN11 A - * P - 2.54 BP - 2
 ① ② ③ ④ ⑤ ⑥ ⑦

① Series name	: PCN11
② Mounting hole type	Blank : With mounting hole A : Without mounting hole
③ Number of contacts	: 10, 16, 20, 32, 44, 50, 64, 90, 96, 100, 128
④ Opening type	P : Male connector
⑤ Contact pitch	: 2.54mm
⑥ BP : Backplane housing	(H : 128 contacts only)
⑦ Board thickness	2 : 2.4mm

■2 Row Backplane (Board thickness: 2.54mm)

●Housing With mounting hole

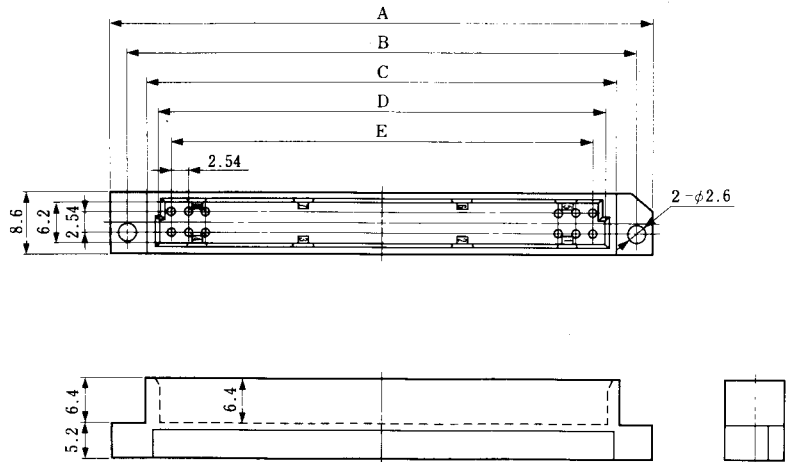

Unit:mm

Part Number	CL No.	Number of Contacts	A	B	C	D	E
PCN11- 20P-2.54H-2	583-1050-2	20	43.3	38.1	32.1	29.47	22.86
PCN11- 32P-2.54H-2	583-1051-5	32	58.54	53.34	47.34	44.71	38.1
PCN11- 44P-2.54H-2	583-1052-8	44	73.78	68.58	62.58	59.95	53.34
PCN11- 50P-2.54H-2	583-1053-0	50	81.4	76.2	70.2	67.57	60.96
PCN11- 64P-2.54H-2	583-1054-3	64	99.18	93.98	87.98	85.35	78.74
PCN11- 90P-2.54H-2	583-1055-6	90	132.2	127	121	118.37	111.76
PCN11-100P-2.54H-2	583-1056-9	100	144.9	139.7	133.7	131.07	124.46

●Housing Without mounting hole

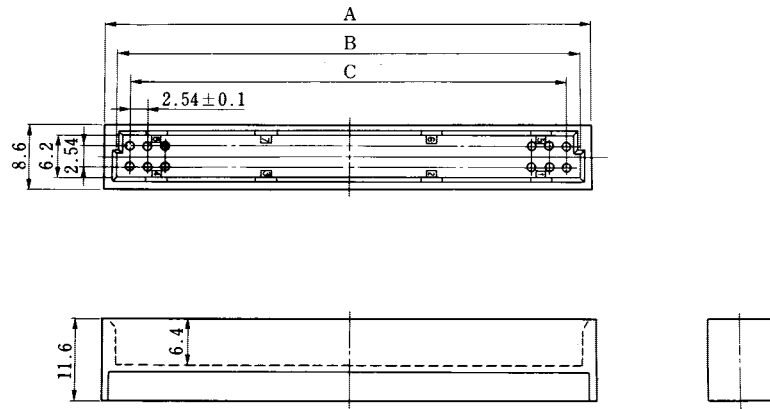
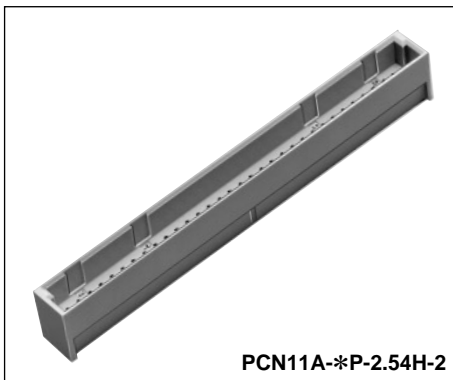

Unit:mm

Part Number	CL No.	Number of Contacts	A	B	C
PCN11A- 20P-2.54H-2	583-1057-1	20	32.1	29.47	22.86
PCN11A- 32P-2.54H-2	583-1058-4	32	47.34	44.71	38.1
PCN11A- 44P-2.54H-2	583-1059-7	44	62.58	59.95	53.34
PCN11A- 50P-2.54H-2	583-1060-6	50	70.2	67.57	60.96
PCN11A- 64P-2.54H-2	583-1061-9	64	87.98	85.35	78.74
PCN11A- 90P-2.54H-2	583-1062-1	90	121	118.37	111.76
PCN11A-100P-2.54H-2	583-1063-4	100	133.7	131.07	124.46

●Contact Board
 (Board thickness: 2.4mm)

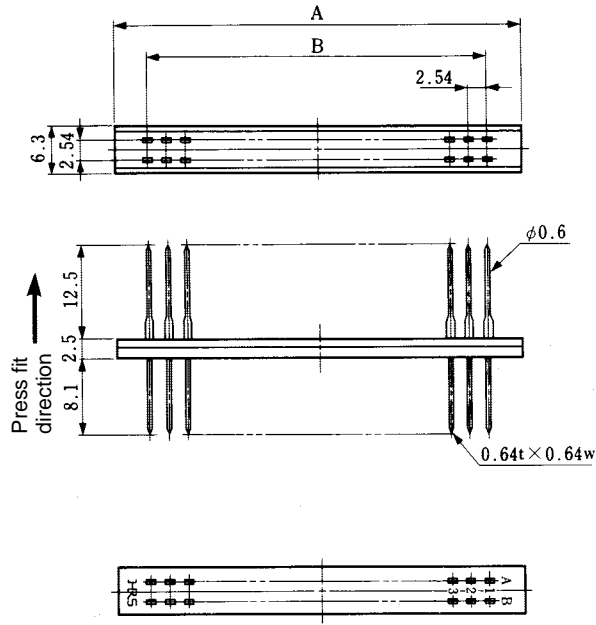
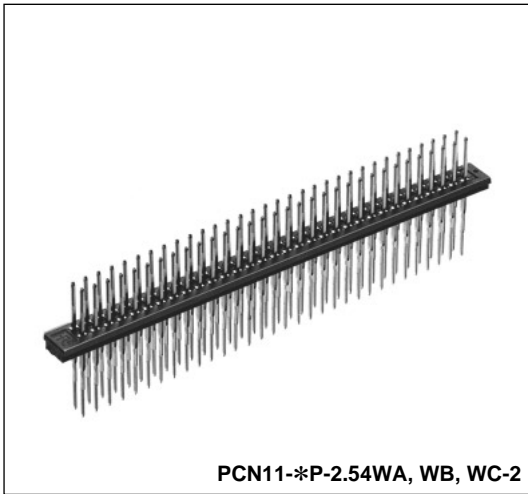

◆PCB mounting pattern

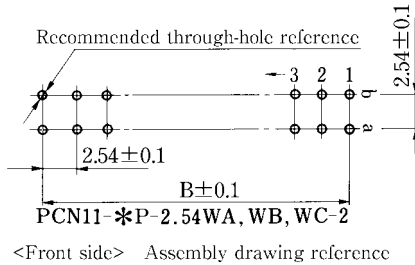

WA(Dia.0.8 through-hole)

Part Number	CL No.	Number of Contacts	A	B
PCN11- 20P-2.54WA-2	583-1011-0	20	32.06	22.86
PCN11- 32P-2.54WA-2	583-1012-3	32	47.3	38.1
PCN11- 44P-2.54WA-2	583-1013-6	44	62.54	53.34
PCN11- 50P-2.54WA-2	583-1014-9	50	70.16	60.96
PCN11- 64P-2.54WA-2	583-1015-1	64	87.94	78.74
PCN11- 90P-2.54WA-2	583-1016-4	90	120.96	111.76
PCN11-100P-2.54WA-2	583-1017-7	100	133.66	124.46

WC(Dia.1.0 through-hole)

Part Number	CL No.	Number of Contacts	A	B
PCN11-100P-2.54WC-2	583-1180-8	100	133.66	124.46

WB(Dia.0.9 through-hole)

Part Number	CL No.	Number of Contacts	A	B
PCN11- 20P-2.54WB-2	583-1043-7	20	32.06	22.86
PCN11- 32P-2.54WB-2	583-1044-0	32	47.3	38.1
PCN11- 44P-2.54WB-2	583-1045-2	44	62.54	53.34
PCN11- 50P-2.54WB-2	583-1046-5	50	70.16	60.96
PCN11- 64P-2.54WB-2	583-1047-8	64	87.94	78.74
PCN11- 90P-2.54WB-2	583-1048-0	90	120.96	111.76
PCN11-100P-2.54WB-2	583-1049-3	100	133.66	124.46

●Key Header
 (Board thickness: 2.4mm)

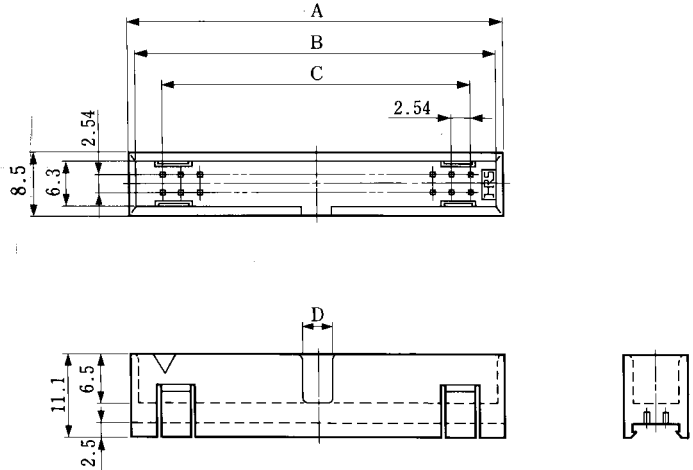

Unit:mm

Part Number	CL No.	Number of Contacts	A	B	C	D
PCN11 -10P-2.54KH	583-1000-4	10	19.36	17.5	10.16	4.1
PCN11 -14P-2.54KH	583-1001-7	14	24.44	22.58	15.24	4.1
PCN11 -16P-2.54KH	583-1002-0	16	26.98	25.12	17.78	4.1
PCN11 -20P-2.54KH	583-1003-2	20	32.06	30.2	22.86	4.1
PCN11 -26P-2.54KH	583-1004-5	26	39.66	37.8	30.48	4.1
PCN11 -30P-2.54KH	583-1005-8	30	44.76	42.9	35.56	4.1
PCN11 -34P-2.54KH	583-1006-0	34	49.86	48	40.64	4.1
PCN11 -40P-2.54KH	583-1007-3	40	57.46	55.6	48.26	4.1
PCN11 -50P-2.54KH	583-1008-6	50	70.16	68.3	60.96	26.96
PCN11A-50P-2.54KH	583-1034-6	50	70.16	68.3	60.96	4.1
PCN11 -60P-2.54KH	583-1009-9	60	82.86	81	73.66	26.96
PCN11A-60P-2.54KH	583-1035-9	60	82.86	81	73.66	4.1
PCN11 -64P-2.54KH	583-1010-8	64	87.96	86.1	78.74	26.96
PCN11A-64P-2.54KH	583-1036-1	64	87.96	86.1	78.74	4.1

<Connectors to correspond to PCN11(A)-*P-2.54KH are HIF3BA-*D-2.54R, HIF3BA-*D-2.54C and HIF3C-*D-2.54C.>

■3 Row Backplane (Board thickness: 2.54mm)

●Housing (With mounting hole)

PCN11-96P-2.54H-2
CL583-1032-0

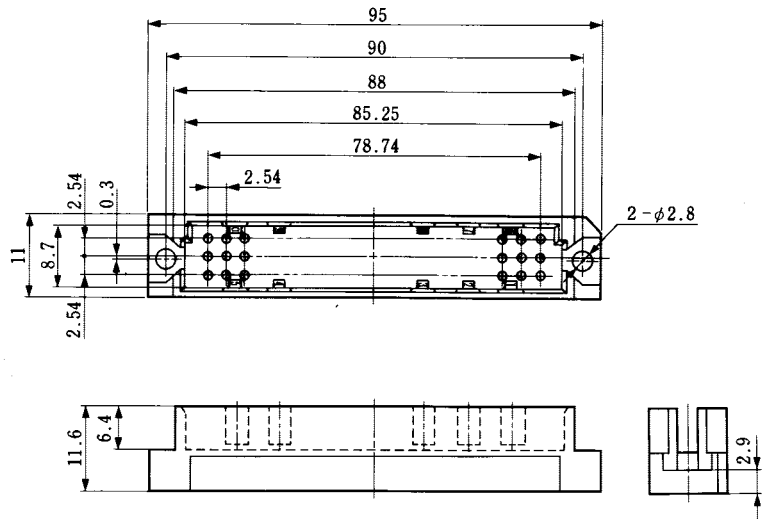

●Housing (Without mounting hole)

PCN11A-96P-2.54H-2
CL583-1033-3

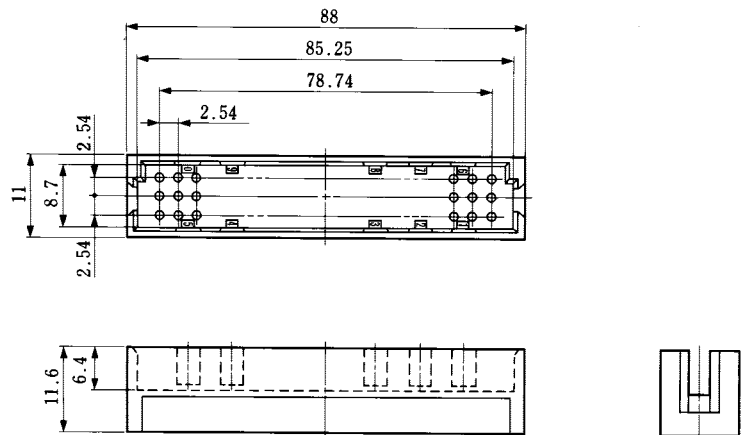

●Contact Board

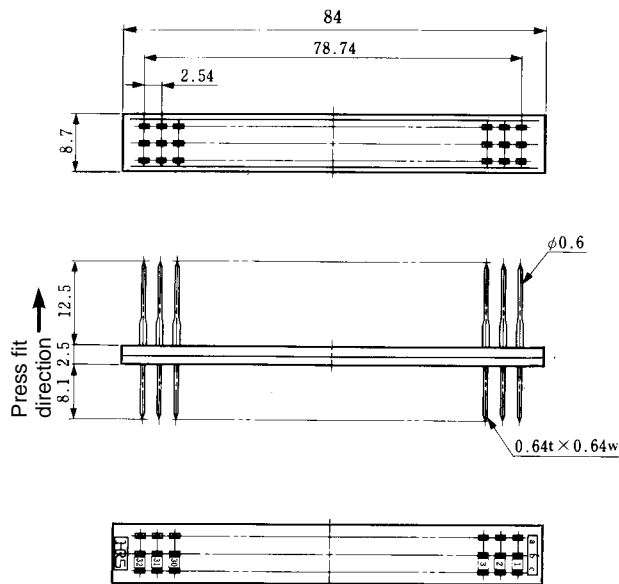
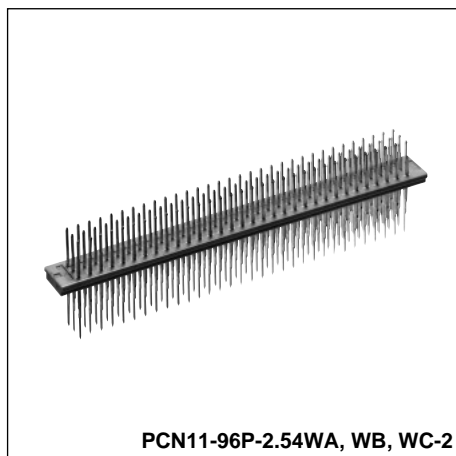

◆PCB mounting pattern

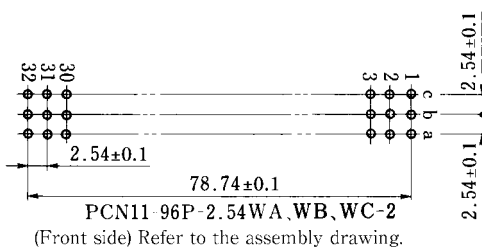

Part Number	CL No.	
PCN11-96P-2.54WA-2	583-1030-5	Dia.0.8 through-hole
PCN11-96P-2.54WB-2	583-1064-7	Dia.0.9 through-hole
PCN11-96P-2.54WC-2	583-1181-0	Dia.1.0 through-hole

●Key header

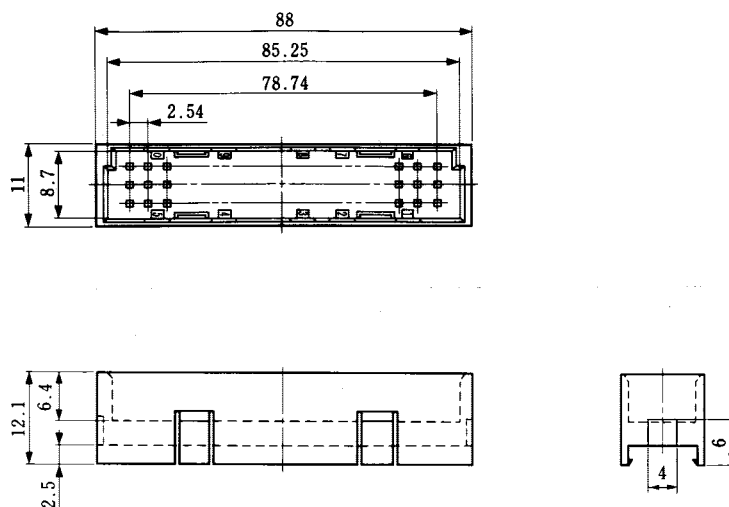

<Connectors to correspond to PCN11-96P-2.54KH are PCN10-64S-2.54R, PCN10-96S-2.54C.>

■Receptacle: 2 Row Short Type

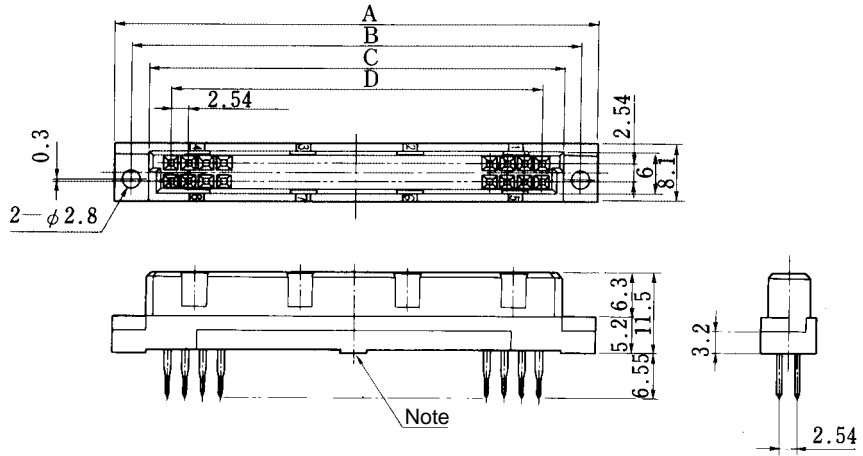
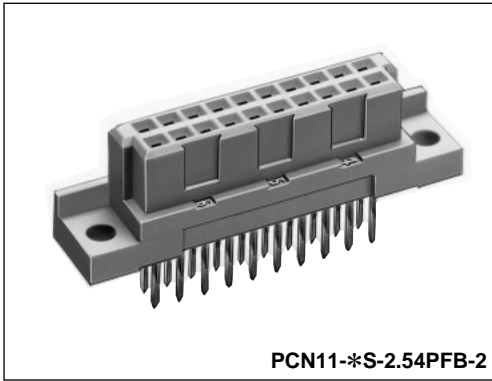

◆PCB mounting pattern

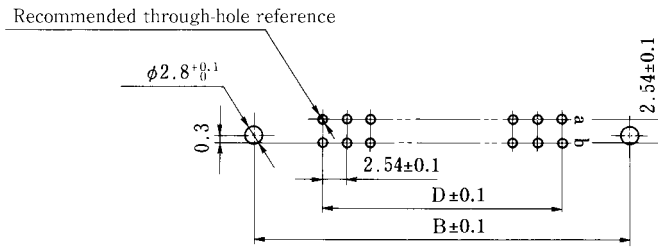

Unit:mm

Part Number	CL No.	Number of Contacts	A	B	C	D
PCN11- 10S-2.54PFB-2	583-1109-3	10	26.42	21.42	16.42	10.16
PCN11- 16S-2.54PFB-2	583-1110-2	16	34.04	29.04	24.04	17.78
PCN11- 20S-2.54PFB-2	583-1111-5	20	39.12	34.12	29.12	22.86
PCN11- 32S-2.54PFB-2	583-1112-8	32	54.36	49.36	44.36	38.1
PCN11- 44S-2.54PFB-2	583-1113-0	44	69.6	64.6	59.6	53.34
PCN11- 50S-2.54PFB-2	583-1114-3	50	77.22	72.22	67.22	60.96
PCN11- 64S-2.54PFB-2	583-1115-6	64	95	90	85	78.74
PCN11- 90S-2.54PFB-2	583-1116-9	90	128.02	123.02	118.02	111.76
PCN11-100S-2.54PFB-2	583-1117-1	100	140.72	135.72	130.72	124.46

NOTE: With stand off for 64, 90, 100 contacts products

■Receptacle: 2 Row Wrapping Backplane Type

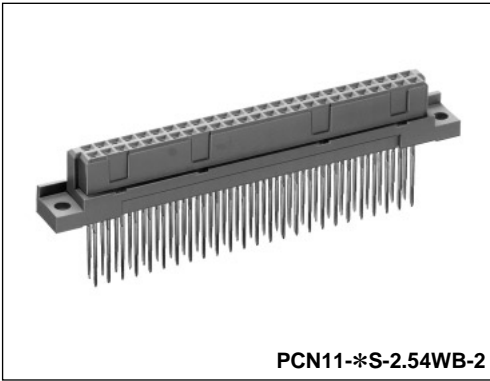

PCN11-*S-2.54WB-2

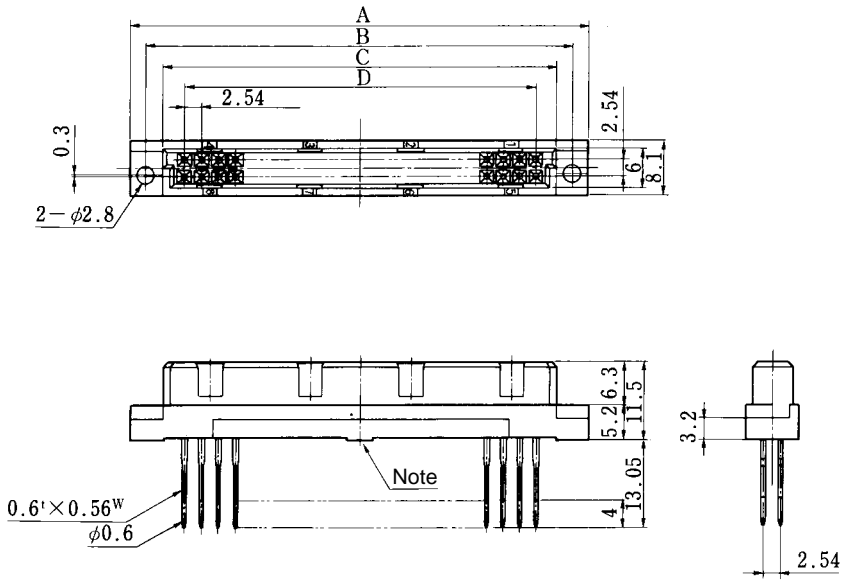

◆PCB mounting pattern

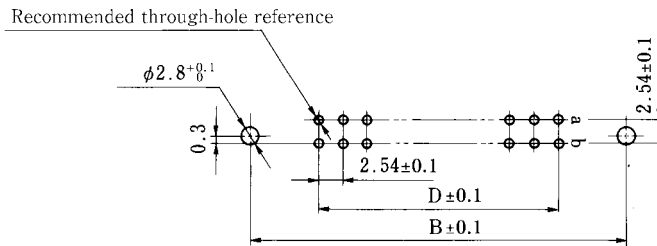

Unit:mm

Part Number	CL No.	Number of Contacts	A	B	C	D
PCN11-10S-2.54WB-2	583-1076-6	10	26.42	21.42	16.42	10.16
PCN11-16S-2.54WB-2	583-1077-9	16	34.04	29.04	24.04	17.78
PCN11-20S-2.54WB-2	583-1078-1	20	39.12	34.12	29.12	22.86
PCN11-32S-2.54WB-2	583-1079-4	32	54.36	49.36	44.36	38.1
PCN11-44S-2.54WB-2	583-1080-3	44	69.6	64.6	59.6	53.34
PCN11-50S-2.54WB-2	583-1081-6	50	77.22	72.22	67.22	60.96
PCN11-64S-2.54WB-2	583-1082-9	64	95	90	85	78.74
PCN11-90S-2.54WB-2	583-1083-1	90	128.02	123.02	118.02	111.76
PCN11-100S-2.54WB-2	583-1084-4	100	140.72	135.72	130.72	124.46

NOTE: With stand off for 64, 90, 100 contacts

■Receptacle : 2 Row Backplane Type (t=2.4mm board)

●Housing (With Mounting hole)

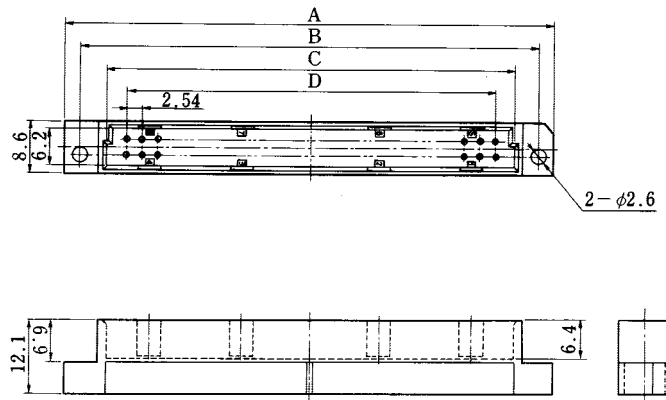
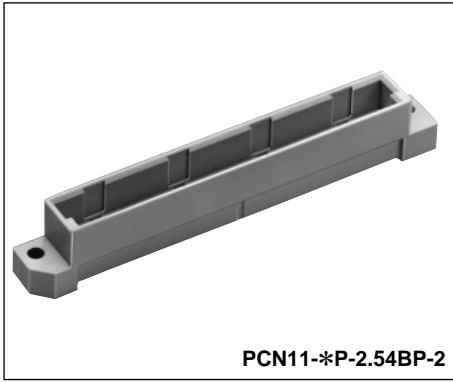

Unit:mm

Part Number	CL No.	Number of Contacts	A	B	C	D
PCN11- 10P-2.54BP-2	583-1131-2	10	30.6	25.4	16.77	10.16
PCN11- 16P-2.54BP-2	583-1132-5	16	38.22	33.02	24.39	17.78
PCN11- 20P-2.54BP-2	583-1133-8	20	43.3	38.1	29.47	22.86
PCN11- 32P-2.54BP-2	583-1134-0	32	58.54	53.34	44.71	38.1
PCN11- 44P-2.54BP-2	583-1135-3	44	73.78	68.58	59.95	53.34
PCN11- 50P-2.54BP-2	583-1136-6	50	81.4	76.2	67.57	60.96
PCN11- 64P-2.54BP-2	583-1137-9	64	99.18	93.98	85.35	78.74
PCN11- 90P-2.54BP-2	583-1138-1	90	132.2	127	118.37	111.76
PCN11-100P-2.54BP-2	583-1140-3	100	144.9	139.7	131.07	124.46

●Housing (Without mounting hole)

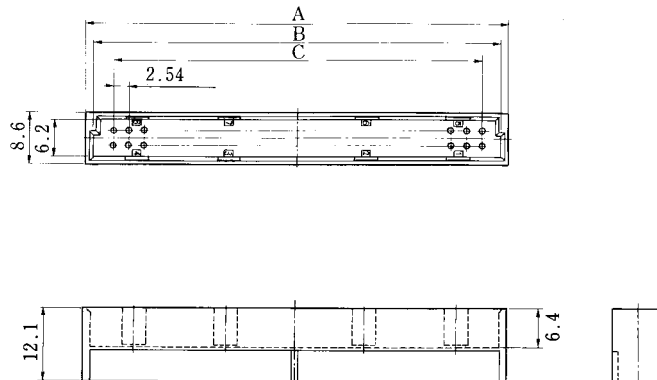
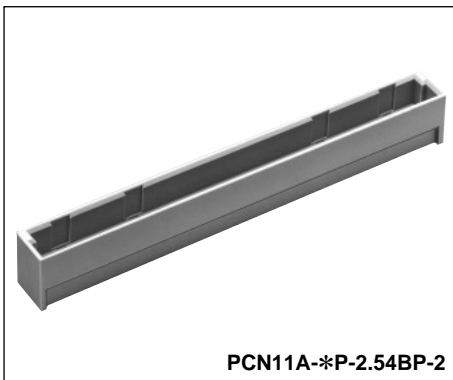

Unit:mm

Part Number	CL No.	Number of Contacts	A	B	C
PCN11A-10P-2.54BP-2	583-1141-6	10	19.4	16.77	10.16
PCN11A-16P-2.54BP-2	583-1142-9	16	27.02	24.39	17.78
PCN11A-20P-2.54BP-2	583-1143-1	20	32.1	29.47	22.86
PCN11A-32P-2.54BP-2	583-1144-4	32	47.34	44.71	38.1
PCN11A-44P-2.54BP-2	583-1145-7	44	62.58	59.95	53.34
PCN11A-50P-2.54BP-2	583-1146-0	50	70.2	67.57	60.96
PCN11A-64P-2.54BP-2	583-1147-2	64	87.98	85.35	78.74
PCN11A-90P-2.54BP-2	583-1148-5	90	121	118.37	111.76
PCN11A-100P-2.54BP-2	583-1150-7	100	133.7	131.07	124.46

■Receptacle: 3 Row Short Type

PCN11-96S-2.54PFB-2
 CL583-1118-4

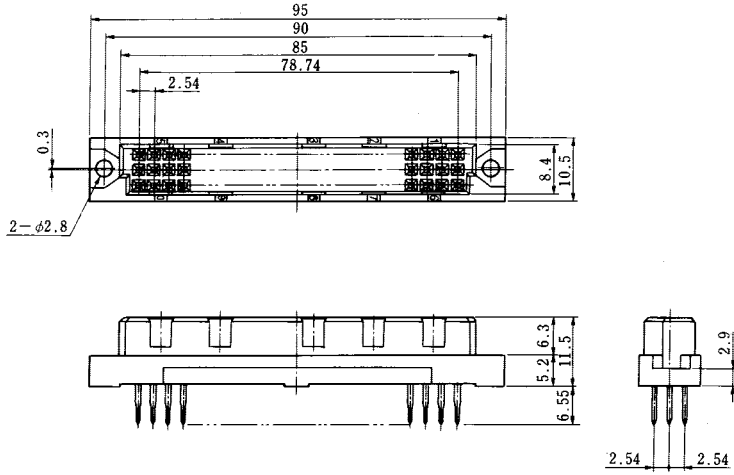
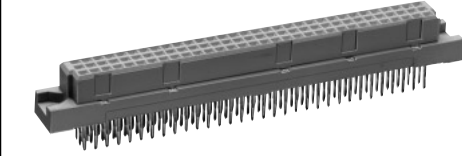

◆PCB mounting pattern

Recommended through-hole reference

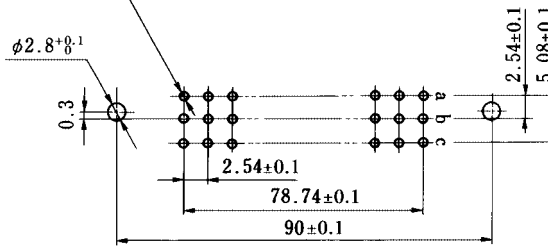

■Receptacle: 3 Row Wrapping Backplane Type

PCN11-96S-2.54WB-2
 CL583-1085-7

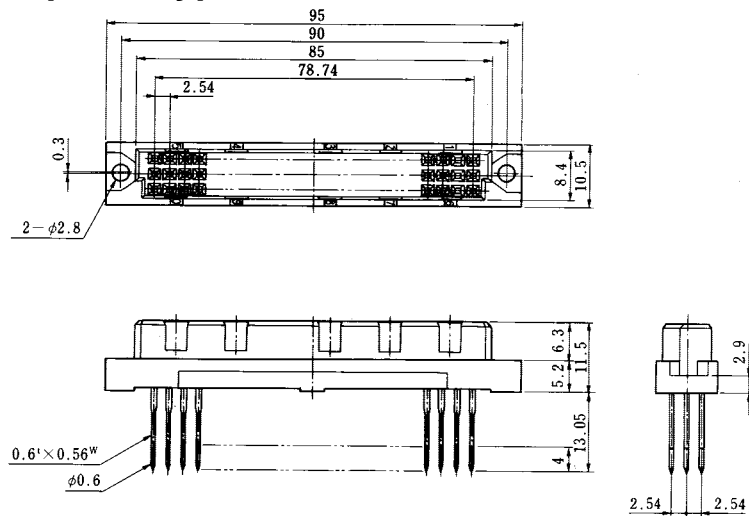

◆PCB mounting pattern

Recommended through-hole reference

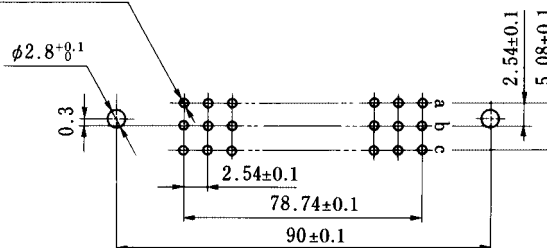

■Receptacle: 3 Row Backplane Type (t=2.45 board)

●Housing (With Mounting hole)

PCN11-96P-2.54BP-2
CL583-1139-4

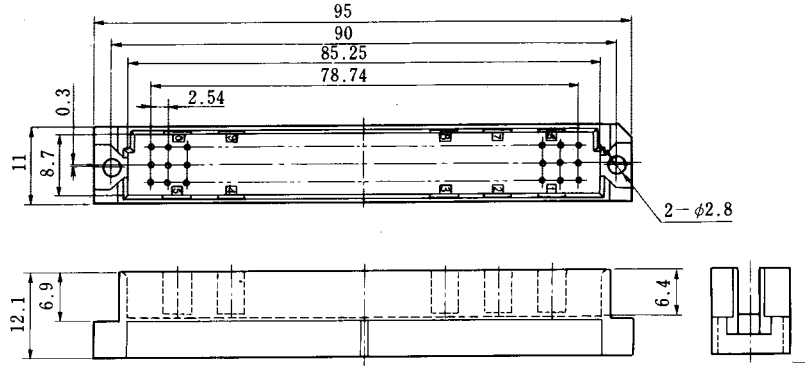
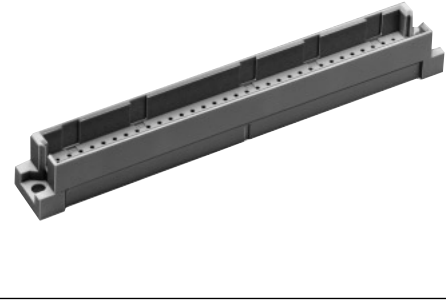

●Housing (Without mounting hole)

PCN11A-96P-2.54BP-2
CL583-1149-8

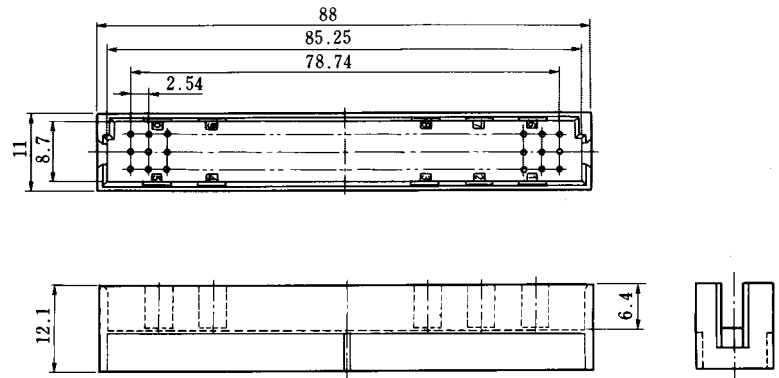
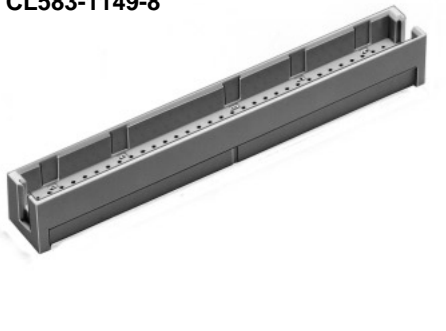

■Receptacle: 4 Row Short Type

PCN11-128S-2.54PFB-2
 CL583-1119-7

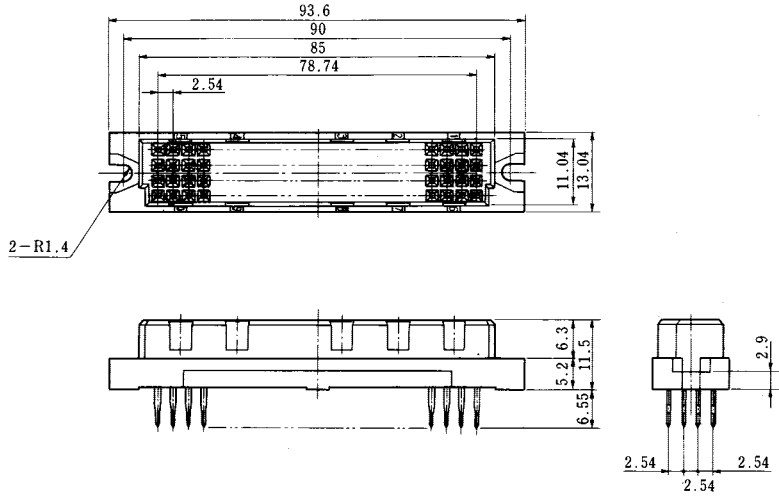
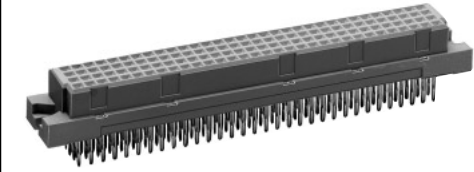

◆PCB mounting pattern

Recommended through-hole reference

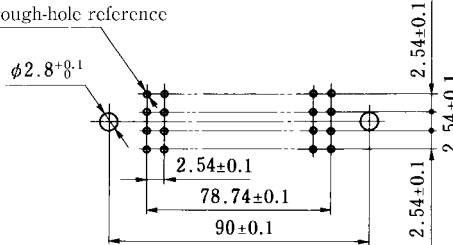

■Receptacle: 4 Row Wrapping Backplane Type

PCN11-128S-2.54WB-2
 CL583-1086-0

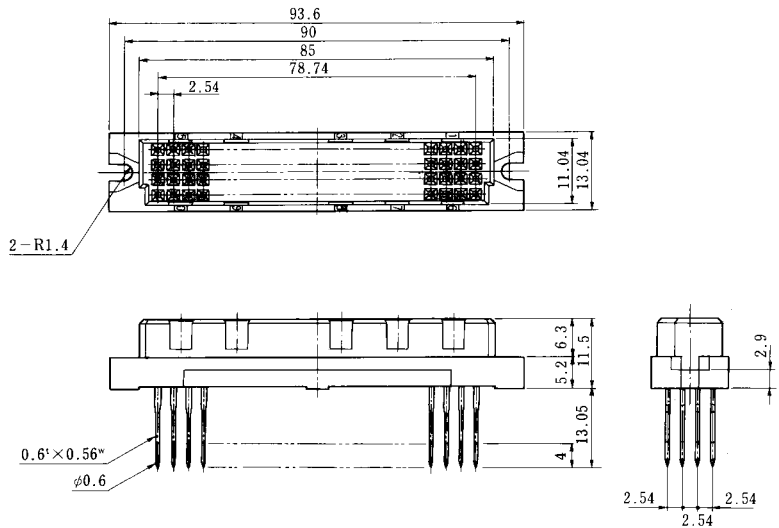
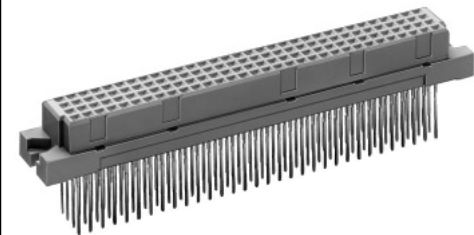

◆PCB mounting pattern

Recommended through-hole reference

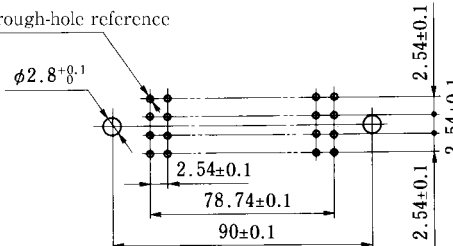

■ Receptacle: 3 Row Backplane Type (t=2.45 board)

● Housing Without mounting hole

PCN11A-128P-2.54H-2
CL583-1151-0

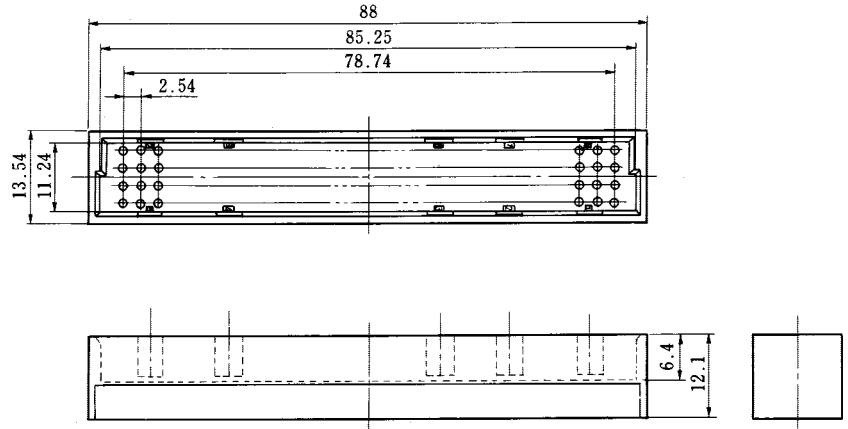
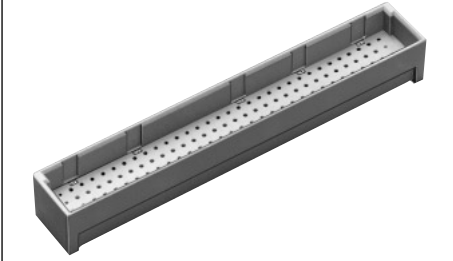

◆ Application

● 2-row type

● Mounting hole center
 C.L. Center line

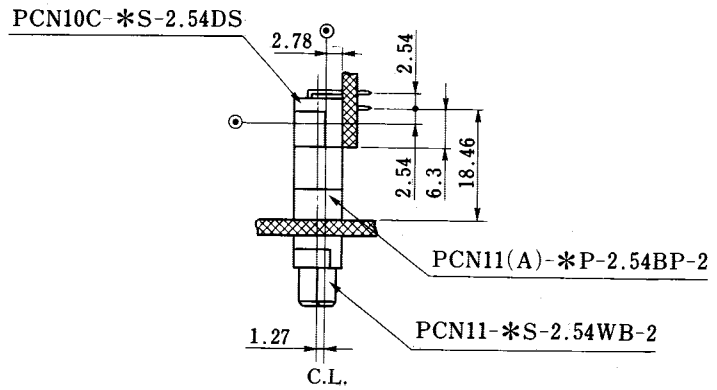
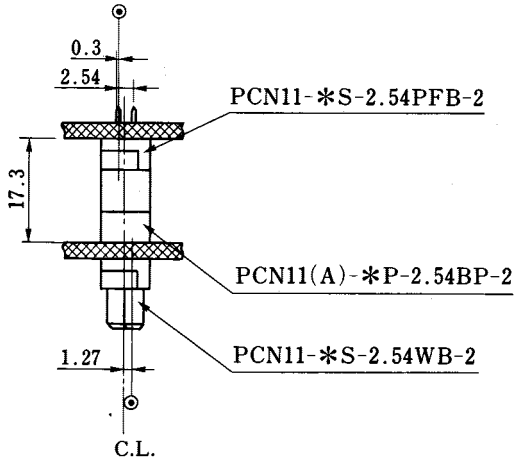

● 3 Row Type

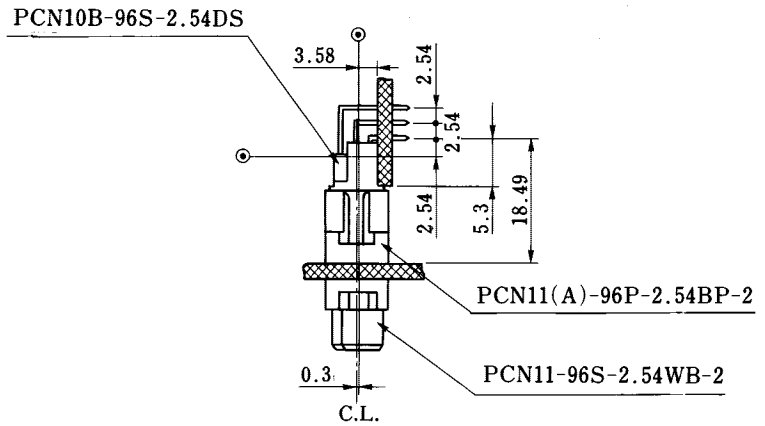
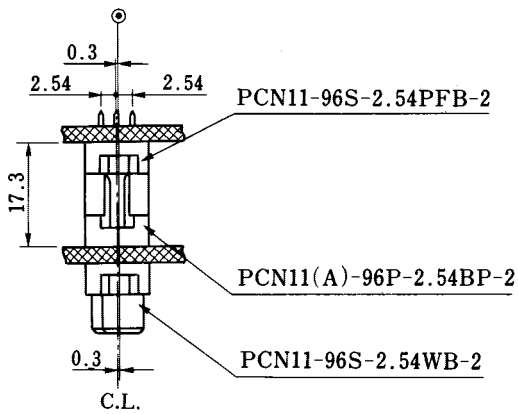

● 4-row type

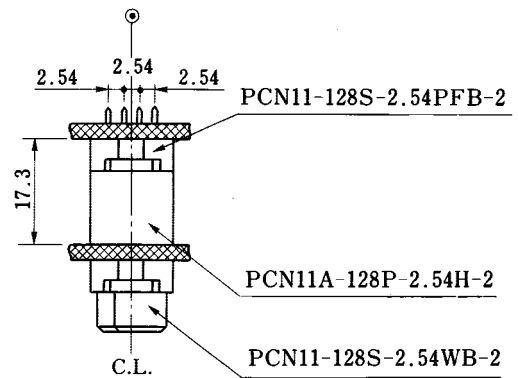
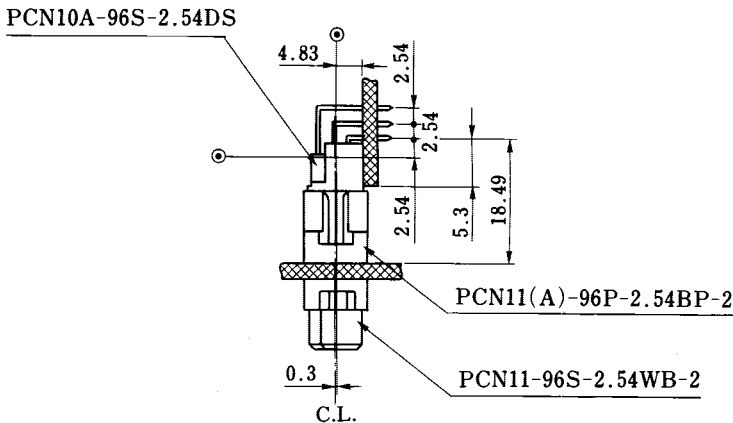

For other combination application patterns, refer to the PCN10 Series catalog.

◆ Recommendation for Press fit Board Assembly

If boards are furnished from the users, HIROSE will assemble the connectors.

Please confirm following requirements.

① Board size: 600 x 600mm max.

② Board through-hole pitch

The board punching bench is designed in the 2.54mm pitch grid. Set the through-hole pitch to pitch (connector side) size to 2.54 x n.

③ Connector punching surface indication

For indication on the connector punching surface, mark "FRONT" or "F", and "BACK" or "B" on the reverse side in order to clearly identify the front and rear sides. In addition, the punching direction should be clearly marked.

④ Clearly indicate the board No. and marking position.

⑤ Clearly indicate board mounting hole positions and hole diameters.

In addition, we provide the press fit board assembly from the both sides, For further information, consult HRS company.

◆ Assembly Drawing

● PCN11

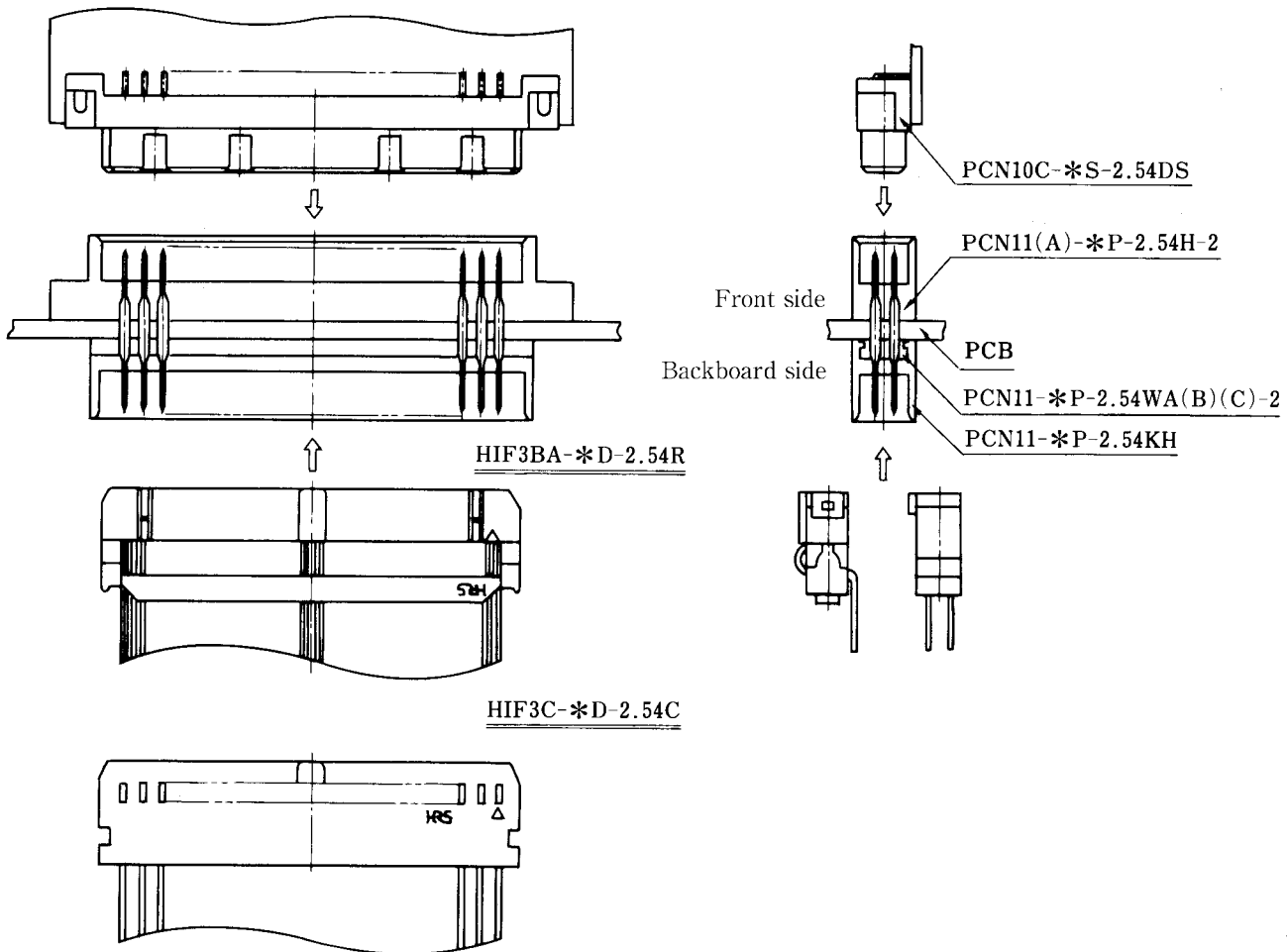

◆ Assembly Drawing

● PCN11 Socket Type

- Combination with PCN10, 12 and 13 can be selected alternatively.
- In connection with the backplane, various assemblies are available. (2.4mm thickness board)

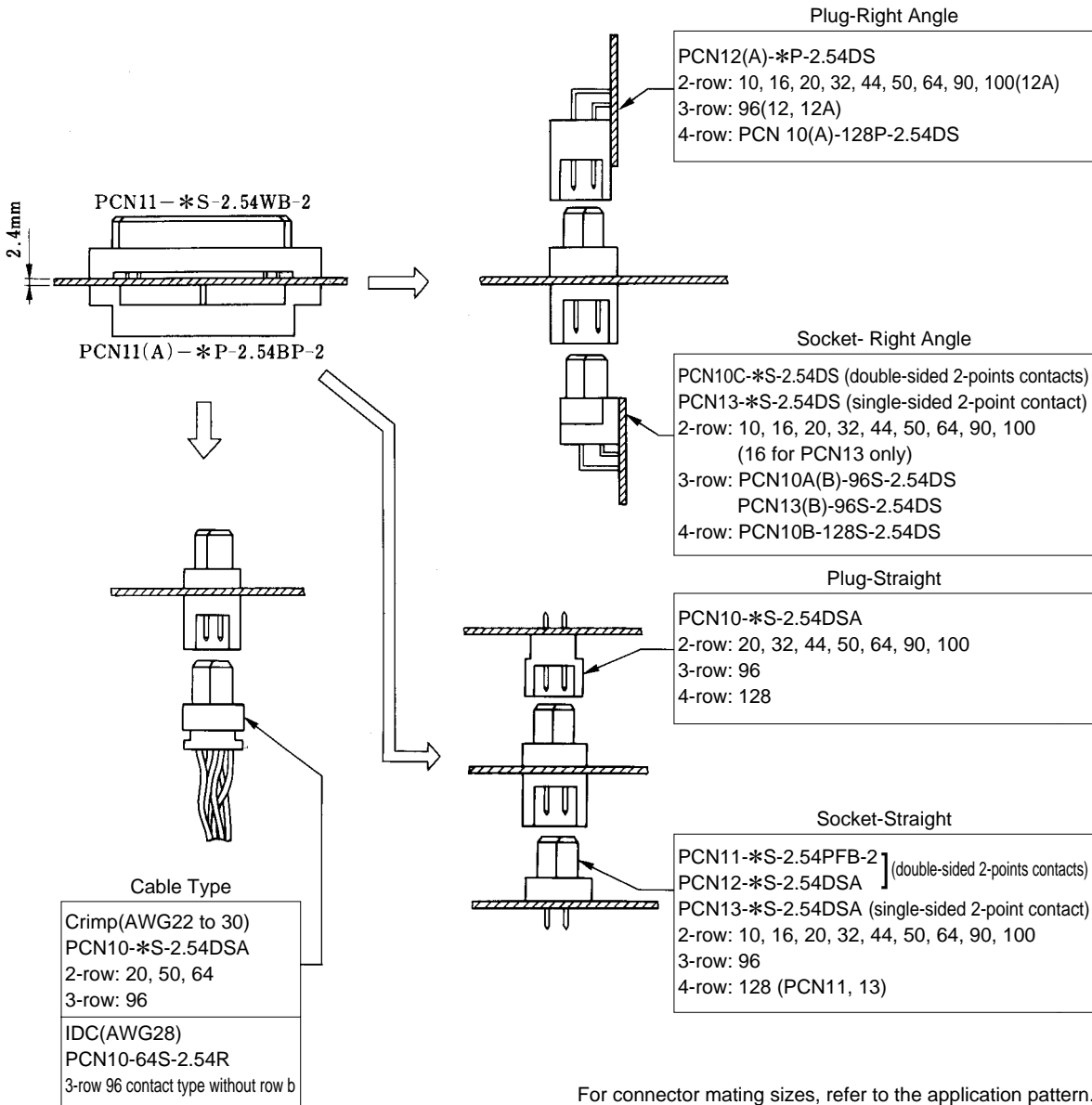

■Recommended Press fit Through-hole

(1) $\phi 0.8$

Drill dia. $\phi 0.9 \pm 0.025$

Finish dia. $\phi 0.8 \pm 0.08$

Copper plating $20 \mu\text{m}$ min.

Solder plating 5 to $10 \mu\text{m}$

(2) $\phi 0.9$

Drill dia. $\phi 1.0 \pm 0.025$

Finish dia. $\phi 0.9 \pm 0.08$

Copper plating $20 \mu\text{m}$ min.

Solder plating 5 to $10 \mu\text{m}$

(3) $\phi 1.0$

Drill dia. $\phi 1.1 \pm 0.025$

Finish dia. $\phi 1.0 \pm 0.08$

Copper plating $20 \mu\text{m}$ min.

Solder plating 5 to $10 \mu\text{m}$

■Applicable Board Material and Board Thickness

- $t=2.4\text{mm}$ (Board thickness tolerance: $\pm 0.2\text{mm}$)
- Material: FR-4, G-10, polyamid

◆Press fit machine

●Features

- By changing the board bed and punch tooling, various connectors can be press fitted.
- The easy height adjustment mechanism allows to obtain a proper pressure height to the board thickness.
- By programming the pre-inserted connector, continuous press-insertion services can proceed.

Mechanical size	(Width) 1330 x (depth) 1600 x (height) 2000mm
Weight	1000kg approx.
Drive source	200V AC Air supply source: normally $5\text{kg}/\text{cm}^2$
Press pressure source	Hydraulic output :5t max.
Board size	600 x 800 mm max.



◆ Press fit Repair Tool

The following tools are used to repair the press fit connector housing and contact.

● Tool to Remove Housing

This tool is used to remove the connector from the board.

Part Number	Applicable Product
PCN11-*S-HP	PCN11-*S-2.54PFB-2
	PCN11-*S-2.54WB-2

*indicates the number of contacts.



● Tool to Remove Contact

After the housing is removed from the board, this tool is used to remove every contact from the board.

Part Number	Applicable Product
PCN11S-PFB-2-CP	PCN11-*S-2.54PFB-2
PCN11S-WB-2-CP	PCN11-*S-2.54WB-2

*indicates the number of contacts.

