

ROHS

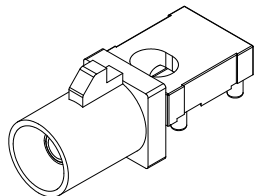

3D View

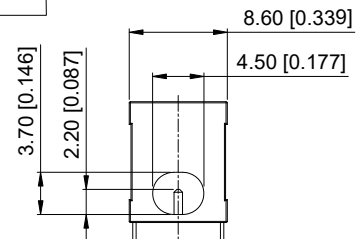
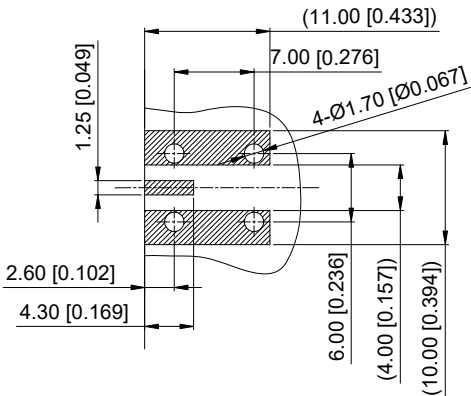
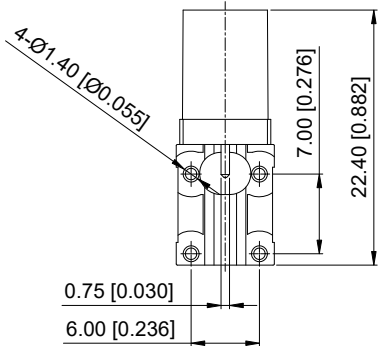
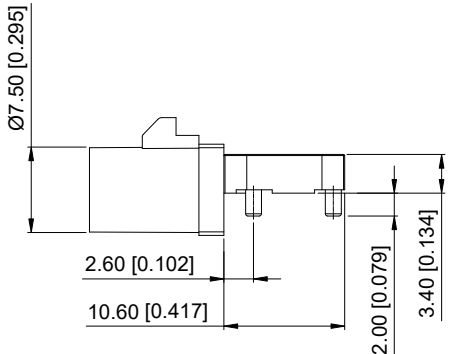
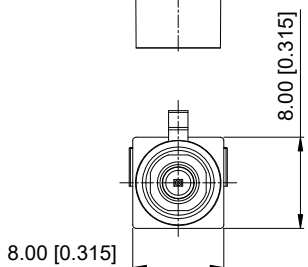

Recommended PCB Layout

		REVISIONS			
REV.	ECN NO.	LOCATION	DESCRIPTION	DATE	DESIGN
A1	ECN-P-2024111301		Interior P/N Change: XK08WMX Change XK1PWM12-ND05-X	2024.11.19	希文

Specifications (规格):

1. Impedance (特性阻抗): 50Ω;
2. Frequency (工作频率): DC~6GHz;
3. Insulation resistance (绝缘阻抗): ≥100MΩ;
4. VSWR (驻波比): ≤1.50 @3GHz;
5. Dielectric withstand voltage (介质耐电压): 800V AC;
6. Mating cycles (耐久性): ≥25 cycles;
7. Engagement force (啮合力): ≤25N;
8. Retention force latch (保持力): ≥110N;
9. Temperature range (使用温度): -40℃~+105℃;

PART NO.:

XK1PWM12-ND05-X

Code: A~Z

ANGULAR	±5°
X.	±0.50
X.x	±0.30
X.xx	±0.20
X.xxx	±0.10

UNSPECIFIED TOLERANCES

4	Dielectric	LCP		1 PC	
3	Outer Conductor	Zinc Alloy	Tin PLATED	1 PC	
2	Center Conductor	Copper Alloy	Gold PLATED	1 PC	
1	Housing	PA9T		1 PC	
NO.	SPEC.	MATERIAL	FINISH (Contact)	Q'TY	Note

www.helloxkb.com www.helloxkb.cn www.xk-dg.cn



DESIGN	希文/Sivan	VIEW:	
CHECKED		UNIT:	mm/in
APPROVED		SIZE:	A4

MODEL TYPE:		
Mid-Mount FAKRA Male Connector		
PART NO.:		
XK1PWM12-ND05-X		
DWG NO.:		
X-XK1PWM12-ND05-X		

XKB INDUSTRIAL PRECISION CO., LIMITED

SCALE	PAGE	REVISION
N/A	1/2	A1





1

2

3

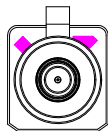
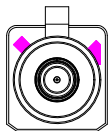
4

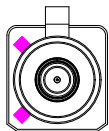
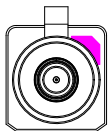
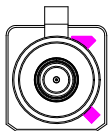
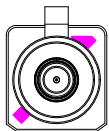
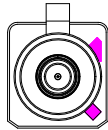
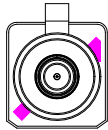
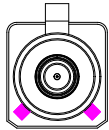
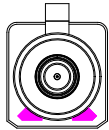
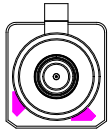
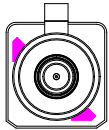
Code List:

Colde							
	A	B	C	D	E	F	G
Color/RAL-No.	Black/9005	White/9001	Blue/5005	Bordeaux/4004	Green/6002	Brown/8011	Grey/7031
PART NO.	XK1PWM12-ND05-A	XK1PWM12-ND05-B	XK1PWM12-ND05-C	XK1PWM12-ND05-D	XK1PWM12-ND05-E	XK1PWM12-ND05-F	XK1PWM12-ND05-G
Colde							
	H	I	K	L	M	N	Z
Color/RAL-No.	Violet/4003	Beige/1001	Curry/1027	Carmine red/3002	Pastel Orange/2003	Pastel Green/6019	Water Blue/5021
PART NO.	XK1PWM12-ND05-H	XK1PWM12-ND05-I	XK1PWM12-ND05-K	XK1PWM12-ND05-L	XK1PWM12-ND05-M	XK1PWM12-ND05-N	XK1PWM12-ND05-Z

ANGULAR	±5°
X.	±0.40
X.x	±0.30
X.xx	±0.20
X.xxx	±0.15
UNSPECIFIED TOLERANCES	



DESIGN	希文/Sivan	VIEW:		MODEL TYPE:	Mid-Mount FAKRA Male Connector	
CHECKED		UNIT:	mm/in	PART NO.:	XK1PWM12-ND05-X	
APPROVED		SIZE:	A4	DWG NO.:	X-XK1PWM12-ND05-X	
				SCALE	PAGE	REVISION
				N/A	2/2	A1

NOTE: ALL RIGHTS RESERVED,BANNED COPY!

www.helloxkb.com www.helloxkb.cn www.xk-dg.cn

XKB INDUSTRIAL PRECISION CO.,LIMITED

1

2

3

4