



MP2722

5A, Single-Cell, I²C-Controlled NVDC Buck Charger with Integrated USB Type-C DRP Detection

DESCRIPTION

The MP2722 is a highly integrated, 5A, switch-mode battery management device for single-cell Li-ion or Li-polymer battery. The narrow-voltage DC (NVDC) power management structure provides low impedance power path that optimizes charging efficiency, reduces battery charging time, and extends battery life during discharging.

The MP2722 is USB Type-C 1.3 compliant, and features dual-role power (DRP) mode with as sink preferred (try.SNK) and source preferred (try.SRC) support. The device's input source type identification algorithm supports USB battery charging specification 1.2 (BC1.2) and non-standard adapter detection.

The I²C interface offers complete operating control, including charging parameter configurations and status/interrupt monitoring.

The MP2722 supports a fully customizable JEITA profile with configurable temperature windows and actions.

The MP2722 is available in a QFN-22 (2.5mmx3.5mm) package.

FEATURES

- USB Type-C 1.3 Compliant
- Fully Integrated CC Controller with Dual-Role Power (DRP) Mode and Autonomous or Manual Mode
- Try.SNK and Try.SRC Mode Support
- Supports USB BC1.2 and Non-Standard Adapters
- 26V Sustainable Input Voltage (V_{IN})
- Configurable 80mA to 5A Charge Current (I_{CC}) via the I²C
- Configurable 100mA to 3.2A Input Current Limit (I_{IN_LIM}) via the I²C
- Minimum V_{IN} Loop for Maximum Adaptor Power Tracking
- Comprehensive Safety Features:
 - Fully Customizable JEITA Profile
 - Additional Negative Temperature Coefficient (NTC) Thermistor Input

- Configurable Die Temperature Regulation from 60°C to 120°C
- Complete Charge and Pre-Charge Safety Timers
- Watchdog Safety Timer
- Lockable Registers for Charging Parameters
- Configurable 750kHz to 1.5MHz Switching Frequency (f_{sw})
- Integrated 15m Ω Low- $R_{DS(ON)}$ Battery MOSFET with Shipping and Reset Modes
- Ultra-Low 8.5 μ A Battery Discharge Current in Shipping Mode
- Down to 30mA Termination Current Settings for Wearable Applications
- I²C Port for Flexible System Parameter Setting and Status Reporting
- Configurable Boost Converter for Source Mode and USB On-The-Go (OTG):
 - Configurable Output Current Limit Loop Up to 3A
 - Output Over-Current Protection (OCP)
 - Ability to Power into Large Capacitive Loads Up to 2mF
 - Configurable 5V to 5.35V Output Voltage
- Accuracy:
 - $\pm 0.5\%$ Battery Regulation Voltage (V_{BATT_REG})
 - $\pm 5\%$ I_{CC}
 - $\pm 5\%$ I_{IN_LIM}
 - Remote Battery Sensing for Fast Charge
 - $\pm 2\%$ Output Regulation in Boost Mode
- Available in a Small QFN-22 (2.5mmx3.5mm) Package

APPLICATIONS

- General $\leq 15W$ USB Type-C Applications
- Bluetooth Headphones
- Bluetooth Speakers
- Point-of-Sale (POS) Terminals
- Portable Cameras

All MPS parts are lead-free, halogen-free, and adhere to the RoHS directive. For MPS green status, please visit the MPS website under Quality Assurance. "MPS", the MPS logo, and "Simple, Easy Solutions" are trademarks of Monolithic Power Systems, Inc. or its subsidiaries.

TYPICAL APPLICATION

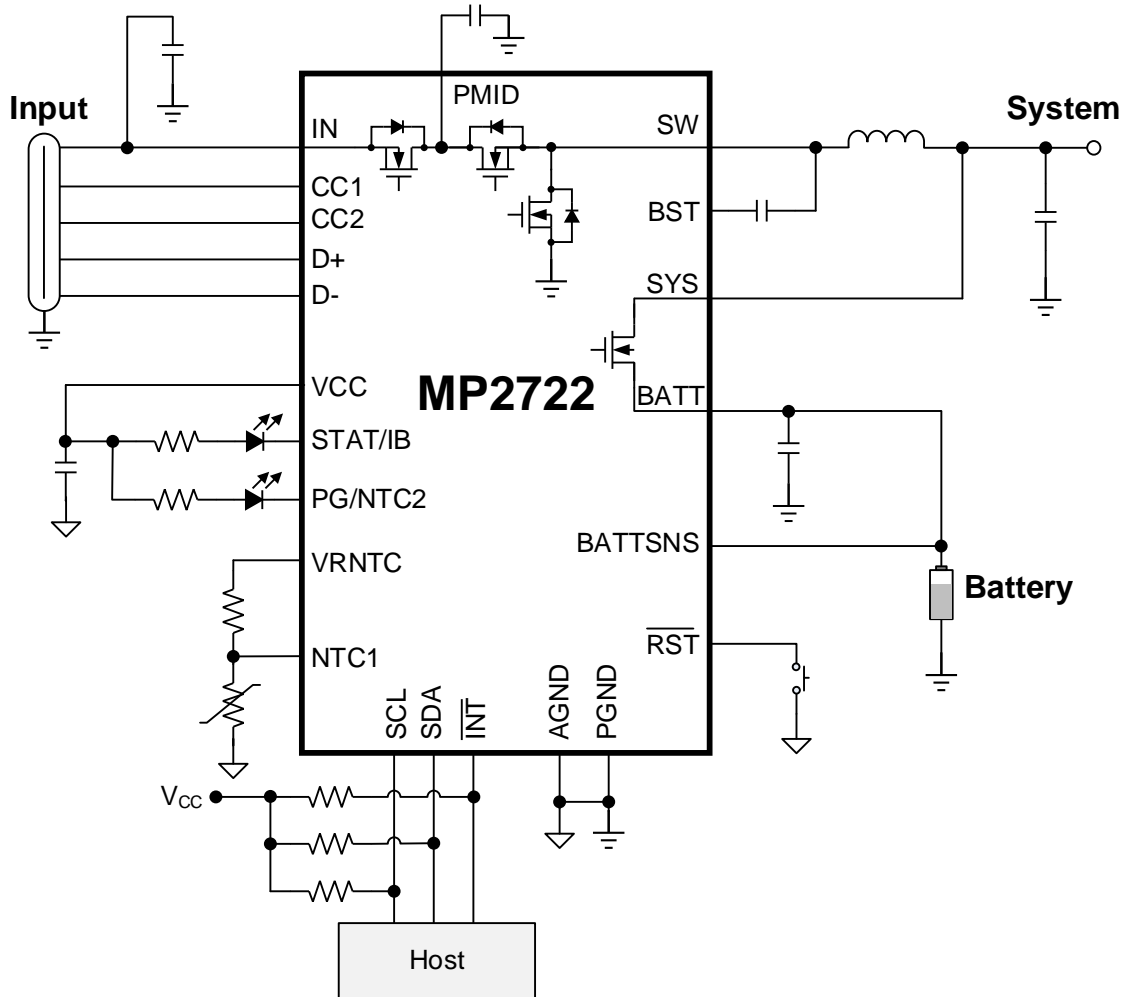

ORDERING INFORMATION

| Part Number* | Package | Top Marking | MSL Rating |
|------------------|----------------------|------------------|------------|
| MP2722GRH-xxxx** | QFN-22 (2.5mmx3.5mm) | <i>See Below</i> | 1 |
| EVKT-MP2722 | Evaluation Kit | | |

* For Tape & Reel, add suffix -Z (e.g. MP2722GRH-xxxx-Z).

** "xxxx" is the register setting option. The factory default code is "-0000". This content can be viewed in the I²C register map. Contact an MPS FAE to obtain an "-xxxx" value.

TOP MARKING

BVP

YWW

LLL

BVP: Product code of MP2722GRH-xxxx

Y: Year code

WW: Week code

LLL: Lot number

EVALUATION KIT EVKT-MP2722

EVKT-MP2722 Kit contents: (Items below can be ordered separately).

| # | Part Number | Item | Quantity |
|---|--------------------|--|----------|
| 1 | EV2722-RH-00A | MP2722 evaluation board | 1 |
| 2 | EVKT-USBI2C-02-BAG | Includes one USB to I ² C communication interface device, one USB cable, and one ribbon cable | 1 |
| 3 | Online resources | Include the datasheet, user guide, product brief, and GUI | 1 |

Order directly from MonolithicPower.com or our distributors.

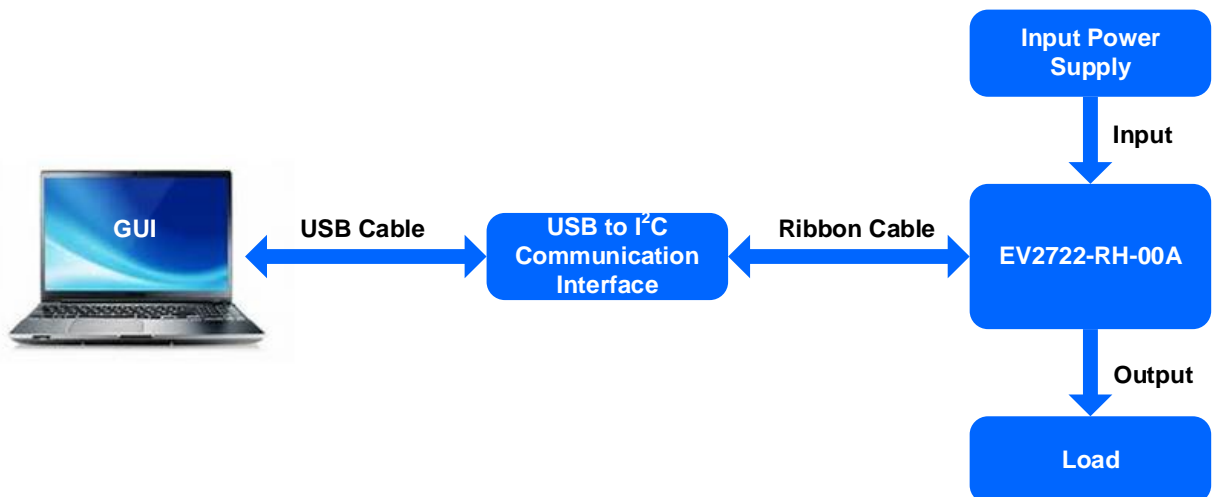
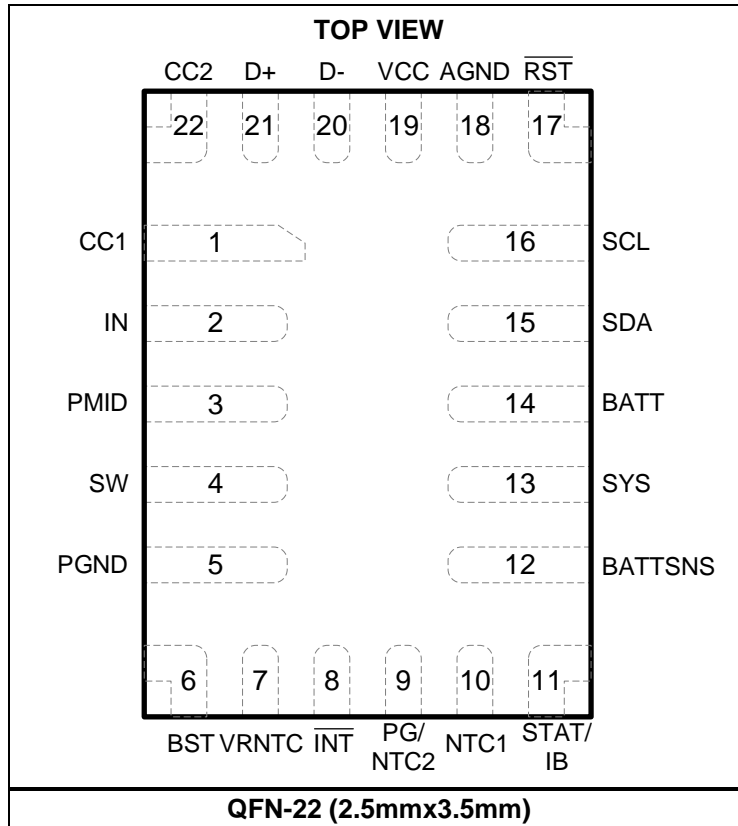

Figure 1: EVKT-MP2722 Evaluation Kit Set-Up

PACKAGE REFERENCE



PIN FUNCTIONS

| Pin # | Name | Type ⁽¹⁾ | Description |
|-------|---------|---------------------|---|
| 2 | IN | P | Power input. Connect a 1 μ F ceramic capacitor from the IN pin to PGND. |
| 3 | PMID | P | Decoupling node for the power stage. Bypass the PMID pin with a minimum 10 μ F ceramic capacitor connected from PMID to PGND, and placed as close to the IC as possible with the shortest possible route. |
| 4 | SW | P | Switching node. Connect the SW pin to the inductor. |
| 6 | BST | P | Bootstrap power. Connect a 22nF capacitor between BST and SW pins to form a floating supply for the high-side MOSFET (HS-FET) driver. |
| 13 | SYS | P | System power output. Connect a minimum 20 μ F ceramic capacitor from the SYS pin to PGND. |
| 14 | BATT | P | Battery positive terminal. The internal narrow-voltage DC (NVDC) battery MOSFET is connected between the SYS and BATT pins. Place a minimum 20 μ F ceramic capacitor from BATT to PGND. |
| 5 | PGND | P | Power ground. Short the PGND pin to AGND on the PCB. |
| 18 | AGND | P | Analog ground. Short the AGND pin to PGND on the PCB. |
| 19 | VCC | P | Internal circuit power supply. Connect a 4.7 μ F ceramic capacitor from the VCC pin to AGND, placed as close to the IC as possible. |
| 12 | BATTSNS | AI | Battery voltage-sense pin for battery voltage regulation. Connect the BATTSNS pin as close as possible to the battery pack's positive terminal. |
| 8 | INT | DO | Open-drain interrupt output. This pin generates an active low 256 μ s pulse when the IC has a status or fault report. Pull this pin up to VCC or another logic rail with a 10k Ω resistor. |
| 16 | SCL | DI | I²C interface clock. Pull the SCL pin up to VCC or another logic rail with a 10k Ω resistor. |
| 15 | SDA | DIO | I²C interface data. Pull the SDA pin up to VCC or another logic rail with a 10k Ω resistor. |
| 1 | CC1 | AIO | USB Type-C CC1 pin. |
| 22 | CC2 | AIO | USB Type-C CC2 pin. |
| 21 | D+ | AIO | Positive line of the USB data line pair. USB charger type detection is based on BC1.2. Non-standard adapter detection can also be implemented. |
| 20 | D- | AIO | Negative line of the USB data line pair. USB charger type detection is based on BC1.2. Non-standard adapter detection can also be implemented. |
| 17 | RST | DI | Battery MOSFET reset input. During shipping mode, pull this pin to logic low for a set time ($t_{SHIPMODE}$) to wake up the IC from shipping mode. When the input voltage (V_{IN}) is not present, setting this pin to logic low for a set time (t_{RST}) resets the SYS power by turning the battery MOSFET off for a set time (t_{SYS_RST}). Then the battery MOSFET is re-enabled. This pin is internally pulled up by a 200k Ω resistor. Float this pin if it is not used. |
| 7 | VRNTC | AO | Voltage output for powering up the NTC. The VRNTC pin is powered up to the same voltage as VCC when the buck or boost converter operates. |
| 10 | NTC1 | AI | Temperature-sense input 1. Connect the NTC1 pin to a negative temperature coefficient (NTC) thermistor. Connect a resistor divider from VRNTC to NTC1 to AGND. NTC1 supports a JEITA profile. |
| 9 | PG/NTC2 | DO/AI | Open-drain power good (PG) indicator. Pull the PG/NTC2 pin up with a 10k Ω resistor. This pin is active low when the VIN_GD bit = 1, and it can be configured to act as temperature-sense input 2. |

PIN FUNCTIONS (continued)

| Pin # | Name | Type ⁽¹⁾ | Description |
|-------|---------|---------------------|---|
| 11 | STAT/IB | DO/AO | Charge status open drain output. Pull up this pin with a 10kΩ resistor. LOW indicates charging in progress. HIGH indicates not in charging or charging completes. Blinking with 1Hz indicates fault happens. Can be configured as battery current indication. IB pin sources a current which is proportional to the charge or discharge current of the battery. Connect a resistor from IB to AGND to get the battery current information. |

Note:

- 1) AI = analog input, AO = analog output, AIO = analog input output, DI = digital input, DO = digital output, DIO = digital input output, P = power.

ABSOLUTE MAXIMUM RATINGS ⁽²⁾

| | |
|---|------------------------------|
| IN to PGND | -0.3V to +26V |
| PMID to PGND | -0.3V to +26V |
| SW to PGND | -0.3V (-2V for 20ns) to +24V |
| PMID to IN | -0.3V to +12V |
| BATT, SYS to PGND | -0.3V to +6.5V |
| BST to SW | -0.3V to +5V |
| CC1, CC2 to AGND | -0.3V to +22V |
| All Other Pins to AGND | -0.3V to +5V |
| Continuous Power Dissipation (T _A = 25°C) ⁽³⁾ | 2W |
| Junction temperature | 150°C |
| Lead temperature (solder) | 260°C |
| Storage temperature | -65°C to +150°C |

ESD Ratings

| | |
|---|-------|
| Human Body Model (HBM) ⁽⁴⁾ | 2000V |
| Charged Device Model (CDM) ⁽⁵⁾ | 250V |

Recommended Operating Conditions ⁽⁷⁾

| | |
|---|-----------------|
| Supply voltage (V _{IN}) | 3.9V to 16V |
| Input current (I _{IN}) | Up to 3.2A |
| System current (I _{SYS}) | Up to 5A |
| Charge current (I _{CC}) | Up to 5A |
| Discharge current (I _{DISCHG}) | Up to 8A |
| Battery voltage (V _{BATT}) | Up to 4.6V |
| Operating junction temp (T _J) | -40°C to +125°C |

Thermal Resistance ⁽⁶⁾ θ_{JA} θ_{JC}

QFN-22 (2.5mmx3.5mm)..... 50..... 12.... °C/W

Notes:

- Exceeding these ratings may damage the device.
- The maximum allowable power dissipation is a function of the maximum junction temperature T_J (MAX), the junction-to-ambient thermal resistance θ_{JA}, and the ambient temperature, T_A. The maximum allowable continuous power dissipation at any ambient temperature is calculated by P_D (MAX) = (T_J (MAX) - T_A) / θ_{JA}. Exceeding the maximum allowable power dissipation can cause excessive die temperature, and the regulator may go into thermal shutdown. Internal thermal shutdown circuitry protects the device from permanent damage.
- Per ANSI/ESDA/JEDEC JS-001, all pins.
- Per ANSI/ESDA/JEDEC JS-002, all pins.
- Measured on JESD51-7, 4-layer PCB.
- The device is not guaranteed to function outside of its operating conditions.

ELECTRICAL CHARACTERISTICS

$T_A = -40^{\circ}\text{C}$ to $+125^{\circ}\text{C}$, $T_A = 25^{\circ}\text{C}$, and $V_{\text{BATT}} = 4\text{V}$ for typical values, unless otherwise noted.

| Parameters | Symbol | Condition | Min | Typ | Max | Units |
|---|----------------------------|---|------|------|-------|------------------|
| Quiescent Current | | | | | | |
| Battery discharge current in shipping mode | $I_{\text{BATT_SHIP}}$ | $V_{\text{BATT}} = 4\text{V}$, $V_{\text{IN}} = 0\text{V}$, BATTFET disabled, $T_A = -40^{\circ}\text{C}$ to $+85^{\circ}\text{C}$ | | 8.5 | 12 | μA |
| Battery discharge current in idle mode | $I_{\text{BATT_IDLE}}$ | $V_{\text{BATT}} = 4\text{V}$, $V_{\text{IN}} = 0\text{V}$, BATTFET enabled, USB Type-C is disabled, $T_A = -40^{\circ}\text{C}$ to $+85^{\circ}\text{C}$ | | 44 | 64 | μA |
| Battery discharge current in sink mode | $I_{\text{BATT_SINK}}$ | $V_{\text{BATT}} = 4\text{V}$, $V_{\text{IN}} = 0\text{V}$, BATTFET enabled, $T_A = -40^{\circ}\text{C}$ to 85°C | | 46 | 65 | μA |
| Battery discharge current in source mode | $I_{\text{BATT_SRC}}$ | $V_{\text{BATT}} = 4\text{V}$, $V_{\text{IN}} = 0\text{V}$, BATTFET enabled, $T_A = -40^{\circ}\text{C}$ to $+85^{\circ}\text{C}$ | | 77 | 95 | μA |
| Battery discharge current in dual-role power (DRP) mode | $I_{\text{BATT_DRP}}$ | $V_{\text{BATT}} = 4\text{V}$, $V_{\text{IN}} = 0\text{V}$, BATTFET enabled, DRP toggle mode, $T_A = -40^{\circ}\text{C}$ to $+85^{\circ}\text{C}$ | | 60 | 79 | μA |
| USB suspend mode current | $I_{\text{IN_SUSP}}$ | $V_{\text{IN}} = 5\text{V}$, $\text{EN_BUCK} = 0$ | | 0.8 | | mA |
| Power-On/Off | | | | | | |
| Input operating range | $V_{\text{IN_OP}}$ | | 3.9 | | 16 | V |
| Input under-voltage lockout (UVLO) threshold | $V_{\text{IN_UV}}$ | V_{IN} falling, $V_{\text{BATT}} = 0\text{V}$ | 3.1 | 3.25 | 3.45 | V |
| Input UVLO hysteresis | $V_{\text{IN_UV_HYS}}$ | V_{IN} rising, $V_{\text{BATT}} = 0\text{V}$ | | 250 | | mV |
| Input debounce time | t_{DEB} | V_{IN} debounce to set $V_{\text{IN_GD}}$ | | 15 | | ms |
| Hold-off timer | t_{HOLD} | $V_{\text{IN_GD}} = 1$ to D+/D- detection starts | | 250 | | ms |
| Input vs. battery voltage headroom threshold | V_{HDRM} | $V_{\text{IN}} - V_{\text{BATT}}$, $V_{\text{BATT}} = 4\text{V}$, V_{IN} rising | 135 | 240 | 340 | mV |
| | | $V_{\text{IN}} - V_{\text{BATT}}$, $V_{\text{BATT}} = 4\text{V}$, V_{IN} falling | 10 | 80 | 175 | mV |
| Input over-voltage protection (OVP) threshold | $V_{\text{IN_OV}}$ | V_{IN} rising, $V_{\text{IN_OVP}} = 6.3\text{V}$ | 6.1 | 6.3 | 6.55 | V |
| | | V_{IN} rising, $V_{\text{IN_OVP}} = 11\text{V}$ | 10.5 | 11 | 11.55 | V |
| | | V_{IN} rising, $V_{\text{IN_OVP}} = 14\text{V}$ | 13.5 | 14 | 14.55 | V |
| Input OVP hysteresis | $V_{\text{IN_OV_HYS}}$ | V_{IN} falling | | 250 | | mV |
| BATT UVLO threshold | $V_{\text{BATT_UV}}$ | $V_{\text{IN}} = 0\text{V}$, V_{BATT} falling | 2.4 | 2.5 | 2.6 | V |
| BATT UVLO hysteresis | $V_{\text{BATT_UV_HYS}}$ | $V_{\text{IN}} = 0\text{V}$, V_{BATT} rising | | 400 | | mV |
| POWER PATH | | | | | | |
| System regulation voltage | $V_{\text{SYS_REG}}$ | $V_{\text{BATT}} < V_{\text{SYS_MIN}}$, $\text{SYS_MIN} = 100$ | 3.7 | 3.82 | 3.94 | V |
| Blocking FET on resistance | $R_{\text{ON_RBFET}}$ | $T_A = 25^{\circ}\text{C}$ | | 15 | | $\text{m}\Omega$ |
| High-side MOSFET (HS-FET) on resistance | $R_{\text{ON_HS}}$ | $T_A = 25^{\circ}\text{C}$ | | 25 | | $\text{m}\Omega$ |
| Low-side MOSFET (LS-FET) on resistance | $R_{\text{ON_LS}}$ | $T_A = 25^{\circ}\text{C}$ | | 25 | | $\text{m}\Omega$ |
| Battery MOSFET on resistance | $R_{\text{ON_BFET}}$ | $T_A = 25^{\circ}\text{C}$ | | 14 | | $\text{m}\Omega$ |
| Battery MOSFET forward voltage in supplement mode | V_{FWD} | | | 30 | | mV |

ELECTRICAL CHARACTERISTICS (continued)
T_A = -40°C to +125°C, T_A = 25°C, and V_{BATT} = 4V for typical values, unless otherwise noted.

| Parameters | Symbol | Condition | Min | Typ | Max | Units |
|---|--------------------------|---|-------|------|-------|-------|
| Charge (T_A = 0°C to 70°C) | | | | | | |
| Charge voltage configuration range | V _{BATT_RANGE} | | 3.6 | | 4.6 | V |
| Charge voltage step | V _{BATT_STEP} | | | 25 | | mV |
| Battery charge voltage regulation | V _{BATT_REG} | V _{BATT} = 4.2V | 4.179 | 4.2 | 4.221 | V |
| | | V _{BATT} = 4.35V | 4.328 | 4.35 | 4.372 | V |
| Charge current regulation range | I _{CC_RANGE} | | 0 | | 5000 | mA |
| Charge current step | I _{CC_STEP} | | | 80 | | mA |
| Fast charge current | I _{CC} | ICC = 1040mA, V _{BATT} = 3.8V | 0.98 | 1.04 | 1.15 | A |
| | | ICC = 2000mA, V _{BATT} = 3.8V | 1.9 | 2 | 2.1 | A |
| Pre-charge to fast charge threshold | V _{BATT_PRE} | V _{BATT} rising, V _{PRE} = 3V | 2.9 | 3 | 3.1 | V |
| Pre-charge to fast charge threshold hysteresis | | V _{BATT} falling, V _{PRE} = 3V | | 250 | | mV |
| Pre-charge current | I _{PRE} | I _{PRE} = 240mA, V _{BATT} = 2.5V | 207.5 | 240 | 277.5 | mA |
| Charge termination current threshold | I _{TERM} | I _{TERM} = 120mA | 90 | 120 | 150 | mA |
| | | I _{TERM} = 30mA | 18 | 30 | 42 | mA |
| Trickle charge to pre-charge threshold | V _{BATT_TC} | V _{BATT} rising | 1.9 | 2 | 2.1 | V |
| Trickle charge to pre-charge threshold hysteresis | | V _{BATT} falling | | 200 | | mV |
| Trickle charge current | I _{TC} | V _{BATT} = 1V, I _{TRICKLE} = 128mA | 100 | 128 | 160 | mA |
| Auto-recharge battery voltage threshold | V _{RECH} | V _{BATT} falling, V _{RECHG} = 100mV | 45 | 90 | 135 | mV |
| | | V _{BATT} falling, V _{RECHG} = 200mV | 135 | 190 | 245 | mV |
| Input Regulation (T_A = 0°C to 70°C) | | | | | | |
| Input minimum voltage regulation | V _{IN_LIM} | V _{IN_LIM} = 3.88V, V _{BATT} = 3.3V | 3.758 | 3.88 | 4.002 | V |
| | | V _{IN_LIM} = 4.36V, V _{BATT} = 3.3V | 4.236 | 4.36 | 4.484 | V |
| Input minimum voltage regulation tracking battery | V _{IN_LIM_BATT} | V _{IN_LIM} = 3.88V, V _{BATT} = 4V | 70 | 165 | 285 | mV |
| Input current limit | I _{IN_LIM} | I _{IN_LIM} = 500mA | 415 | 450 | 500 | mA |
| | | I _{IN_LIM} = 1.5A | 1.34 | 1.41 | 1.5 | A |
| | | I _{IN_LIM} = 3A | 2.7 | 2.84 | 3 | A |
| Battery Over-Voltage Protection (OVP) | | | | | | |
| Battery OVP threshold | V _{BATT_OVP} | V _{BATT} rising, percentage of V _{BATT_REG} | 103 | 105 | 106.5 | % |
| Battery OVP hysteresis | | | | 1.7 | | % |
| Thermal | | | | | | |
| Junction temperature regulation ⁽⁸⁾ | T _{J_REG} | T _{REG} = 80°C | | 80 | | °C |
| | | T _{REG} = 120°C | | 120 | | °C |
| Thermal shutdown rising junction temperature ⁽⁸⁾ | T _{J_SHDN} | Temperature rising | | 150 | | °C |
| Thermal shutdown hysteresis ⁽⁸⁾ | T _{SHDN_HYS} | | | 30 | | °C |

ELECTRICAL CHARACTERISTICS (continued)
T_A = -40°C to +125°C, T_A = 25°C, and V_{BATT} = 4V for typical values, unless otherwise noted.

| Parameters | Symbol | Condition | Min | Typ | Max | Units |
|--|-------------------------|--|------|------|------|-------|
| JEITA NTC Monitor (T_A = 0°C to 70°C) | | | | | | |
| NTC cold temperature rising threshold | V _{COLD} | As a percentage of V _{VRNTC} , V _{COLD} = 74.2% (0°C) | 73.9 | 74.5 | 75.1 | % |
| NTC cold temperature rising threshold hysteresis | | As a percentage of V _{VRNTC} | | 1.4 | | % |
| NTC cool temperature rising threshold | V _{COOL} | As a percentage of V _{VRNTC} , V _{COOL} = 64.8% (10°C) | 64.3 | 64.9 | 65.5 | % |
| NTC cool temperature rising threshold hysteresis | | As a percentage of V _{VRNTC} | | 1.4 | | % |
| NTC warm temperature falling threshold | V _{WARM} | As a percentage of V _{VRNTC} , V _{WARM} = 32.6% (45°C) | 31.9 | 32.5 | 33.1 | % |
| NTC warm temperature falling threshold hysteresis | | As a percentage of V _{VRNTC} | | 1.4 | | % |
| NTC hot temperature falling threshold | V _{HOT} | As a percentage of V _{VRNTC} , V _{HOT} = 23% (60°C) | 22.7 | 23.3 | 23.9 | % |
| NTC hot temperature falling threshold hysteresis | | As a percentage of V _{VRNTC} | | 1.4 | | % |
| BATTFET Over-Current Protection (OCP) | | | | | | |
| BATTFET over-current (OC) threshold | I _{BATT_OCP} | | 7 | | | A |
| PWM Converter | | | | | | |
| Switching frequency | f _{SW} | SW_FREQ = 750kHz | 630 | 750 | 895 | kHz |
| | | SW_FREQ = 1000kHz | 900 | 1050 | 1280 | kHz |
| | | SW_FREQ = 1250kHz | 1060 | 1250 | 1450 | kHz |
| | | SW_FREQ = 1500kHz | 1260 | 1475 | 1680 | kHz |
| Boost | | | | | | |
| Boost regulation voltage | V _{PMID_REG} | V _{BOOST} = 5.15V, T _A = -40°C to +85°C | 5.08 | 5.15 | 5.22 | V |
| BATT_LOW comparator falling threshold | V _{BATT_LOW} | BATT_LOW = 3V | 2.88 | 3 | 3.12 | V |
| | | BATT_LOW = 3.3V | 3.2 | 3.33 | 3.46 | V |
| BATT_LOW comparator hysteresis | | | | 200 | | mV |
| BATT_LOW comparator debounce time | t _{D_BATT_LOW} | | | 10 | | ms |
| Boost output current limit | I _{BST_LIM} | OLIM = 500mA, T _A = 0°C to 70°C | 500 | | 615 | mA |
| | | OLIM = 1.5A, T _A = 0°C to 70°C | 1500 | | 1700 | mA |
| Boost OVP threshold | V _{BST_OVP} | Boost mode, V _{IN} rising | 5.5 | 5.8 | 6.1 | V |
| VCC LDO | | | | | | |
| VCC output voltage | V _{VCC} | V _{IN} = 5V, I _{VCC} = 5mA | | 3.65 | | V |
| IB Output (T_A = 0°C to 70°C) | | | | | | |
| IB current output gain | I _{IB} | I _{IB} , charging, I _{BATT} = 100mA | 1.1 | 2 | 2.8 | μA |
| | | I _{IB} , charging, I _{BATT} = 1A | 18.2 | 20 | 22.1 | μA |
| | | I _{IB} , discharging, I _{BATT} = 100mA | 1.1 | 2 | 2.8 | μA |
| | | I _{IB} , discharging, I _{BATT} = 1A | 18.2 | 20 | 22.1 | μA |

ELECTRICAL CHARACTERISTICS (continued)
T_A = -40°C to +125°C, T_A = 25°C, and V_{BATT} = 4V for typical values, unless otherwise noted.

| Parameters | Symbol | Condition | Min | Typ | Max | Units |
|---|-----------------------|--------------------------------|------|------|------|-------|
| Impedance Test | | | | | | |
| Input impedance test current | I _{VIN_SRC} | IVIN_SRC = 10μA | 6 | 10 | 14 | μA |
| | | IVIN_SRC = 40μA | 28 | 40 | 52 | μA |
| | | IVIN_SRC = 320μA | 240 | 320 | 405 | μA |
| Input impedance test voltage threshold | V _{VIN_TEST} | VIN_TEST = 0.5V | 0.46 | 0.5 | 0.54 | V |
| | | VIN_TEST = 1.5V | 1.4 | 1.5 | 1.6 | V |
| Logic I/O for SCL, SDA, INT, RST, STAT | | | | | | |
| Logic input low voltage | V _{IL} | | | | 0.4 | V |
| Logic input high voltage | V _{IH} | | 1.3 | | | V |
| Open-drain output low voltage | V _{OL} | I _{SINK} = 10mA | | | 0.2 | V |
| RST pull-up resistor | R _{PULL_UP} | | | 200 | | kΩ |
| D+/D- Detection | | | | | | |
| DCD D+ pull up current | I _{DP_SRC} | | 7 | 10 | 13 | μA |
| DCD D- pull low resistance | R _{DM_DWN} | | 16 | 20 | 24 | kΩ |
| D+/D- source voltage low | V _{SRC_L} | | 550 | 600 | 650 | mV |
| D+/D- source voltage high | V _{SRC_H} | | 3.1 | 3.3 | 3.5 | V |
| D+/D- sink current | I _{SNK} | | 50 | 100 | 150 | μA |
| Data detect voltage | V _{DAT_REF} | | 300 | 350 | 400 | mV |
| Non-standard 1.2V window | V _{1P2_TH} | Low threshold | 0.95 | 1 | 1.05 | V |
| | | High threshold | 1.33 | 1.4 | 1.47 | V |
| Non-standard 2V window | V _{2P0_TH} | Low threshold | 1.73 | 1.8 | 1.87 | V |
| | | High threshold | 2.17 | 2.25 | 2.33 | V |
| Non-standard 2.7V window | V _{2P7_TH} | Low threshold | 2.3 | 2.4 | 2.5 | V |
| | | High threshold | 2.9 | 3 | 3.1 | V |
| USB Type-C CC Detection | | | | | | |
| CC1 and CC2 pull-down resistance | R _{RD} | | 4.6 | 5.1 | 5.6 | kΩ |
| CC1 and CC2 pull-up current source | I _{RP} | RP_CFG = 80μA | 70 | 80 | 90 | μA |
| | | RP_CFG = 180μA | 165 | 180 | 195 | μA |
| | | RP_CFG = 330μA | 305 | 330 | 350 | μA |
| Sink port vRd-Connect threshold | V _{RD_CNCT} | | 0.17 | 0.2 | 0.23 | V |
| Sink port vRd-USB threshold | V _{RD_USB} | | 0.63 | 0.66 | 0.69 | V |
| Sink port vRd-1.5 threshold | V _{RD_1P5} | | 1.22 | 1.26 | 1.3 | V |
| Source port vRd-USB threshold | V _{SRC_RD_1} | RP_CFG = 80μA, low threshold | 0.17 | 0.2 | 0.23 | V |
| | | RP_CFG = 80μA, high threshold | 1.55 | 1.6 | 1.65 | V |
| Source port vRd-1.5A threshold | V _{SRC_RD_2} | RP_CFG = 180μA, low threshold | 0.37 | 0.4 | 0.43 | V |
| | | RP_CFG = 180μA, high threshold | 1.55 | 1.6 | 1.65 | V |

ELECTRICAL CHARACTERISTICS (continued)
T_A = -40°C to +125°C, T_A = 25°C, and V_{BATT} = 4V for typical values, unless otherwise noted.

| Parameters | Symbol | Condition | Min | Typ | Max | Units |
|---|--------------------------|--------------------------------|------|------|------|-------|
| Source port vRd-3A threshold | V _{SRC_RD_3} | RP_CFG = 330μA, low threshold | 0.81 | 0.84 | 0.88 | V |
| | | RP_CFG = 330μA, high threshold | 2.5 | 2.6 | 2.7 | V |
| USB Type-C attachment debounce time | t _{CC_DEBOUNCE} | | 120 | 150 | 180 | ms |
| CC pin debounce time for PD | t _{PD_DEBOUNCE} | | 12 | 15 | 18 | ms |
| USB Type-C resistor (Rp) value change debounce time | t _{RP_CHANGE} | | 12 | 15 | 18 | ms |
| DRP toggle period | t _{DRP} | | 70 | 80 | 90 | ms |
| Duty cycle of advertised source port | d _{SRC_DRP} | | 40 | 50 | 60 | % |
| Try.SRC wait time | t _{DRP_TRY} | | 90 | 120 | 135 | ms |
| Try.SRC debounce time | t _{TRYCCDEB} | | 12 | 15 | 18 | ms |
| Try.SRC timeout | t _{TRYTIMEOUT} | | 900 | 1000 | 1100 | ms |
| Timing | | | | | | |
| Start-Up | | | | | | |
| Legacy cable timer | t _{LEGACY} | | 65 | 75 | 85 | ms |
| Battery Charger | | | | | | |
| Charge termination deglitch time | t _{TERM_DGL} | | | 250 | | ms |
| Charge timer | t _{CHG_TMR} | CHG_TIMER = 10hr | 8 | 10 | 12 | hr |
| Top-off timer | t _{TOP_OFF} | TOPOFF_TIMER = 30min | 24 | 30 | 36 | min |
| Battery auto-recharge deglitch time | t _{RECH_DGL} | | | 100 | | ms |
| RST Timing | | | | | | |
| RST low time to exit shipping mode | t _{SHIPMODE} | | 0.9 | 1.1 | 1.3 | sec |
| RST low time to reset BATTFET | t _{RST} | | 8 | 10 | 12 | sec |
| BATTFET reset time | t _{SYS_RST} | | 250 | 330 | 400 | ms |
| Enter shipping mode delay | t _{SHIP_DLY} | | 10 | 12 | 15 | sec |
| Watchdog and Clock | | | | | | |
| Watchdog timer | t _{WDT} | WATCHDOG = 40s | | 40 | | sec |
| I ² C clock | f _{SCL} | | | | 400 | kHz |

Notes:

8) Guaranteed by design.

TYPICAL PERFORMANCE CHARACTERISTICS

$V_{IN} = 5V$, $V_{BATT} = \text{full range}$, I²C-controlled, $I_{CC} = 2A$, $I_{IN_LIM} = 3A$, $V_{IN_MIN} = 4.36V$, $L = 1\mu H$ (DCR = 12m Ω), $T_A = 25^\circ C$, unless otherwise noted.

Charge Efficiency

$V_{BATT} = 3.8V$, $L = 1\mu H$
(DCR = 12m Ω)

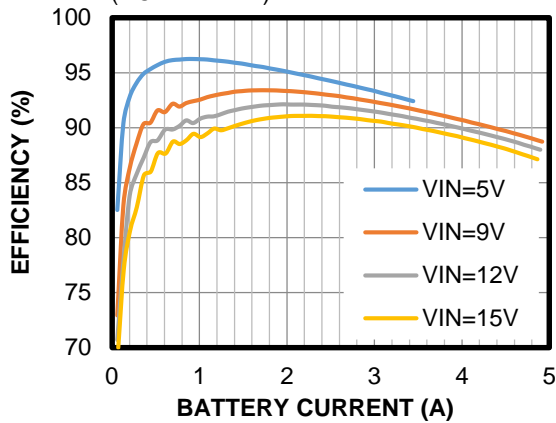

Boost Efficiency

$V_{BOOST} = 5.15V$, $L = 1\mu H$
(DCR = 12m Ω)

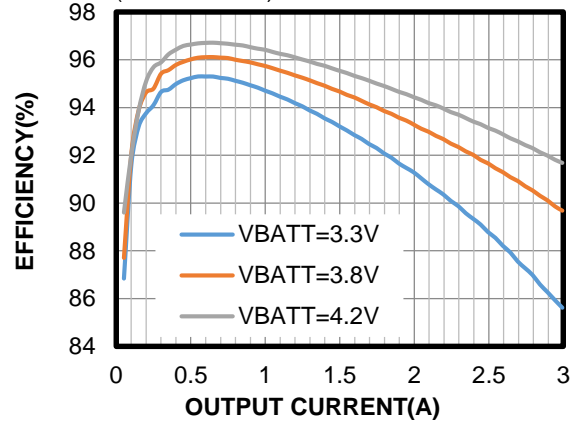

Battery Regulation Voltage vs. Temperature

$V_{BATT} = 4.2V$

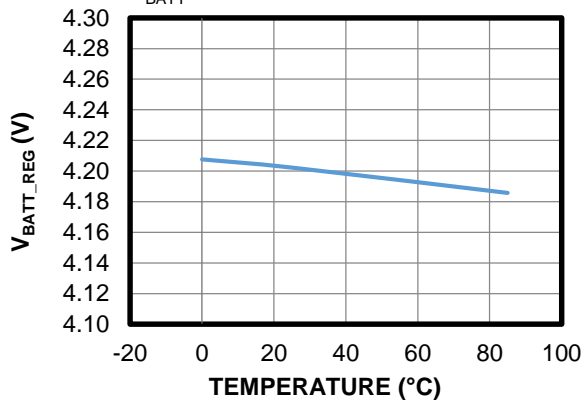

Shipping Mode Current vs. Temperature

$V_{BATT} = 4V$

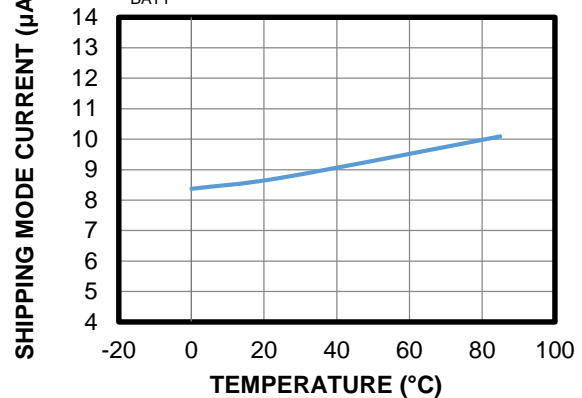

Input Current Limit vs. Temperature

$I_{IN_LIM} = 500mA$

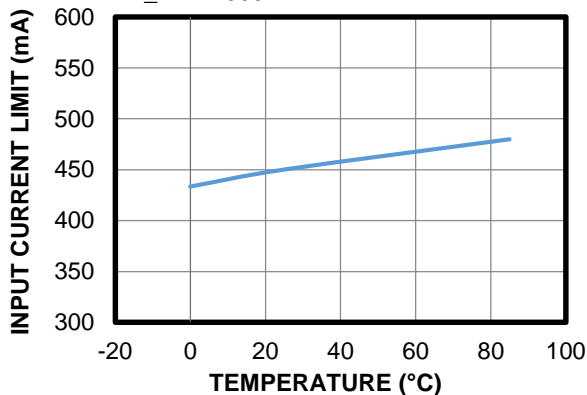

Charge Current vs. Temperature

$I_{CC} = 1040mA$, $V_{BATT} = 3.8V$

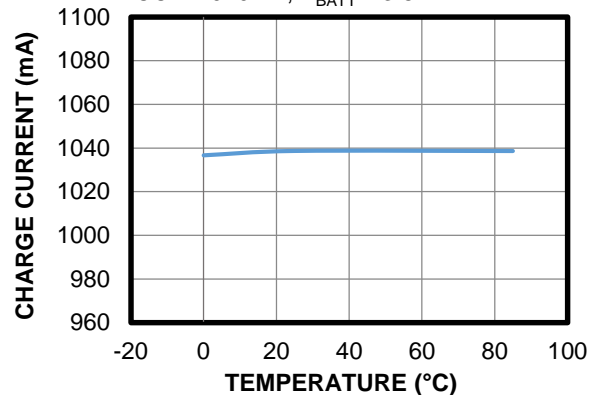

TYPICAL PERFORMANCE CHARACTERISTICS (continued)

$V_{IN} = 5V$, $V_{BATT} = \text{full range}$, I²C-controlled, $I_{CC} = 2A$, $I_{IN_LIM} = 3A$, $V_{IN_MIN} = 4.36V$, $L = 1\mu H$ (DCR = 12m Ω), $T_A = 25^\circ C$, unless otherwise noted.

Adapter Plugged In

$I_{CC} = 2A$, $V_{BATT} = 3.3V$, $I_{SYS} = 0A$, DRP mode

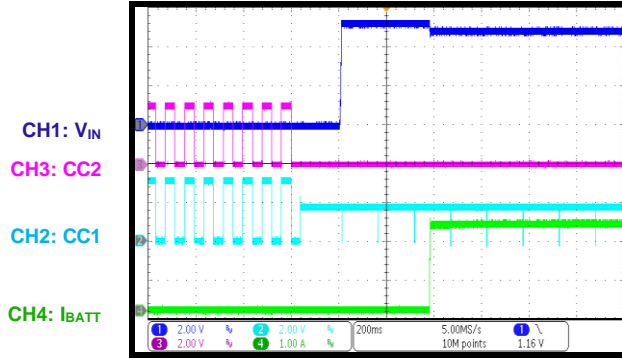

Adapter Plugged In

$I_{CC} = 2A$, $V_{BATT} = 3.3V$, $I_{SYS} = 0A$, DRP mode with Try.SRC

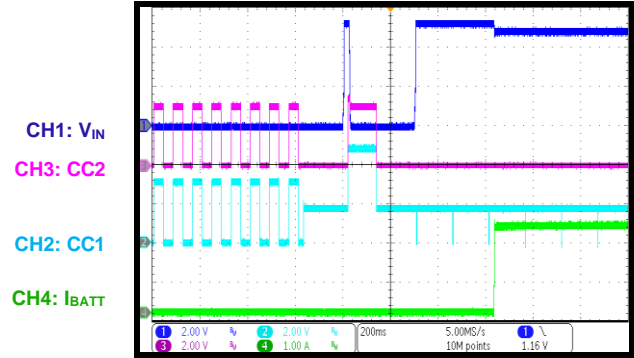

Battery Charge Profile

$V_{IN} = 5V$, $I_{CC} = 2A$, $I_{SYS} = 0A$

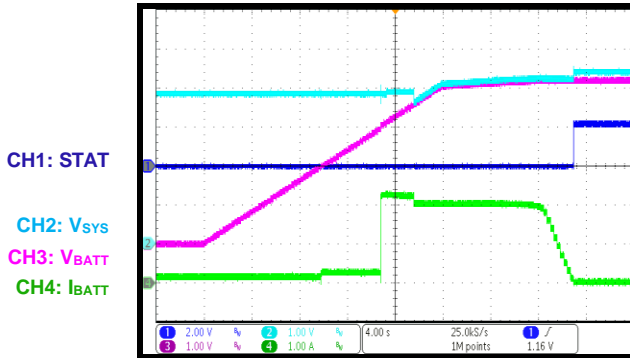

Charge Steady State

$V_{IN} = 5V$, $V_{BATT} = 3.8V$, $I_{CC} = 2A$, $I_{SYS} = 0A$

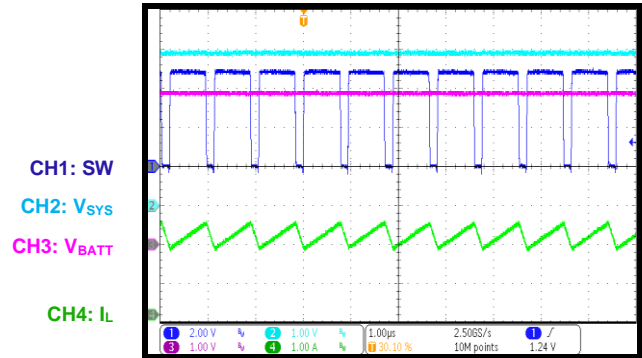

Charge Steady State

$V_{IN} = 9V$, $V_{BATT} = 3.8V$, $I_{CC} = 5A$, $I_{SYS} = 0A$

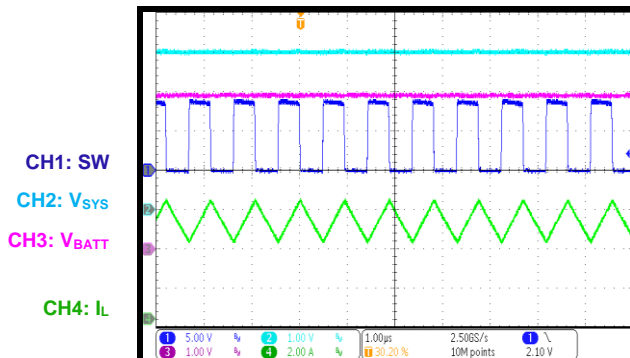

Charge Steady State

$V_{IN} = 16V$, $V_{BATT} = 3.8V$, $I_{CC} = 5A$, $I_{SYS} = 0A$

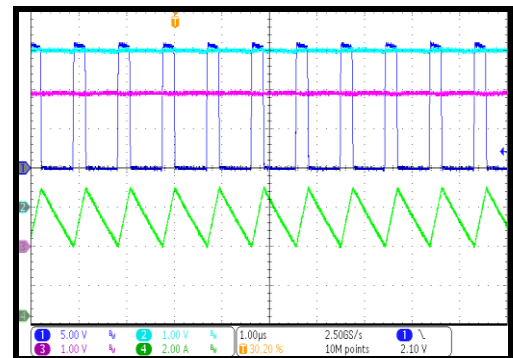

TYPICAL PERFORMANCE CHARACTERISTICS (continued)

V_{IN} = 5V, V_{BATT} = full range, I²C-controlled, I_{CC} = 2A, I_{IN_LIM} = 3A, V_{IN_MIN} = 4.36V, L = 1μH (DCR = 12mΩ), T_A = 25°C, unless otherwise noted.

Charge Disable Steady State

V_{IN} = 5V, V_{BATT} = 3V, I_{SYS} = 1A

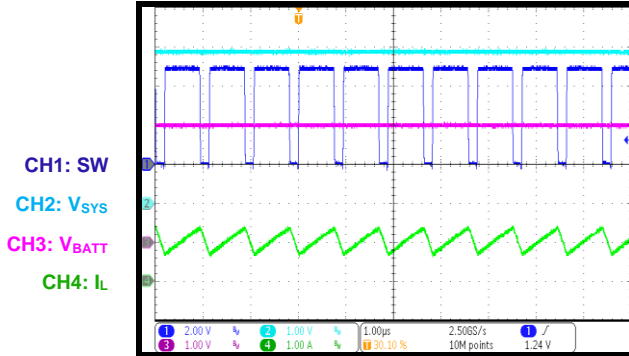

Charge Disable Steady State

V_{IN}=16V, V_{BATT}=3V, Charge disable, I_{SYS}=1A

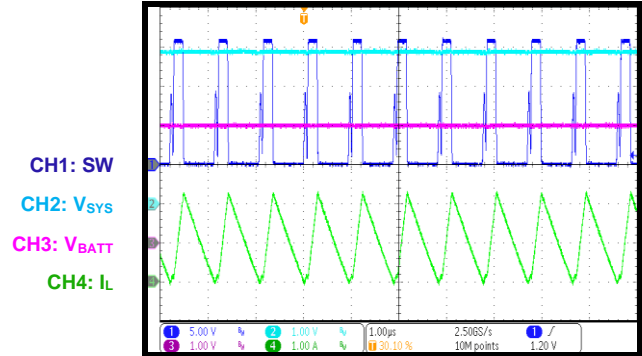

Charge Enabled

V_{IN} = 5V, V_{BATT} = 3.3V, I_{CC} = 2A, I_{SYS} = 0A

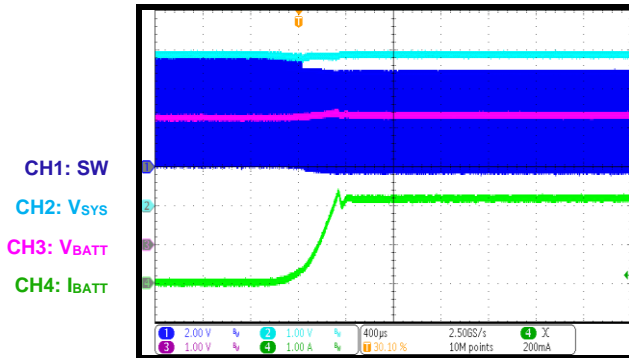

Charge Disabled

V_{IN} = 5V, V_{BATT} = 3.3V, I_{CC} = 2A, I_{SYS} = 0A

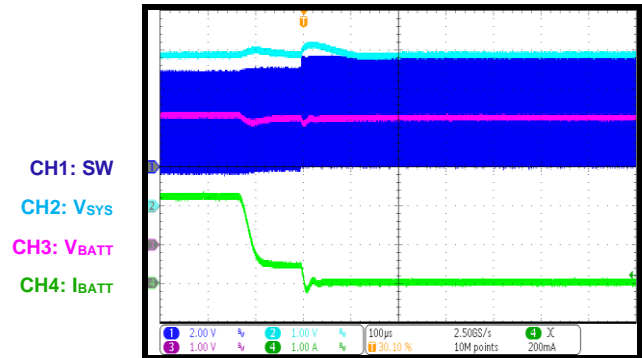

Start-Up

V_{IN} = 5V, V_{BATT} = 3.3V, I_{CC} = 2A, I_{SYS} = 0A

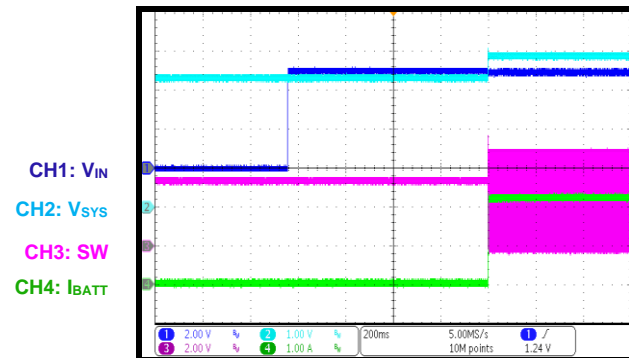

Shutdown

V_{IN} = 5V, V_{BATT} = 3.3V, I_{CC} = 2A, I_{SYS} = 0A

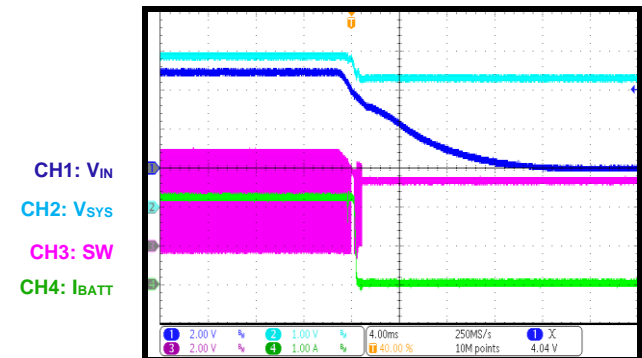

TYPICAL PERFORMANCE CHARACTERISTICS (continued)

V_{IN} = 5V, V_{BATT} = full range, I²C-controlled, I_{CC} = 2A, I_{IN_LIM} = 3A, V_{IN_MIN} = 4.36V, L = 1μH (DCR = 12mΩ), T_A = 25°C, unless otherwise noted.

Input Current Limit

V_{IN} = 5V, I_{IN_LIM} = 1500mA, V_{BATT} = 3.8V, I_{CC} = 1040mA

CH2: I_{IN}
CH1: V_{SYS}
CH3: I_{SYS}
CH4: I_{BATT}

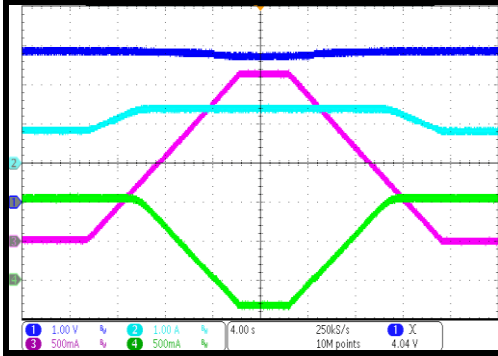

Input Voltage Limit

V_{IN} = 5V (2A), I_{IN_LIM} = 3000mA, V_{BATT} = 3.8V, I_{CC} = 1040mA

CH3: V_{SYS}
CH2: I_{SYS}
CH1: V_{IN}
CH4: I_{BATT}

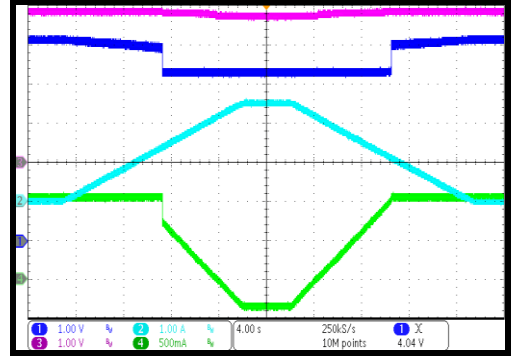

SYS Load Transient

V_{IN} = 5V, V_{BATT} = 3.3V, charge disabled, I_{SYS} = 1A to 3A

CH2: V_{SYS/AC}
CH3: SW
CH1: V_{IN}
CH4: I_{SYS}

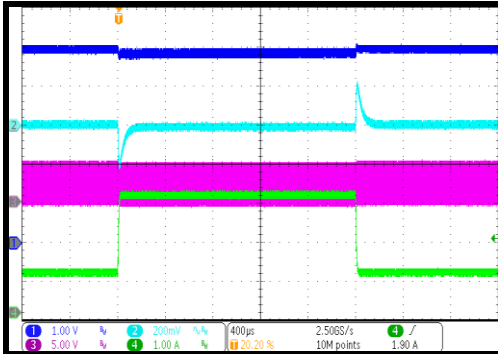

BATTFET Reset

V_{BATT} = 3.8V, I_{SYS} = 0.5A

CH1: /RST
CH3: V_{BATT}
CH2: V_{SYS}
CH4: I_{SYS}

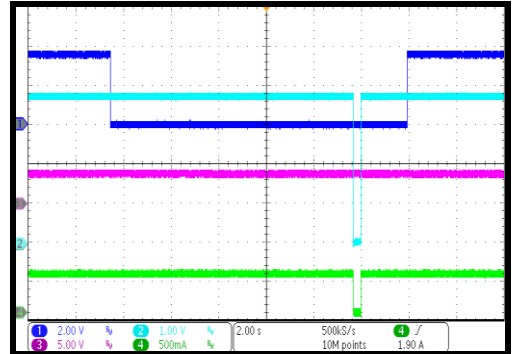

OTG Mode On

V_{BATT} = 3.8V, V_{BOOST} = 5.15V, I_{OTG} = 2A

CH1: V_{IN}
CH3: SW
CH2: V_{BATT}
CH4: I_{OTG}

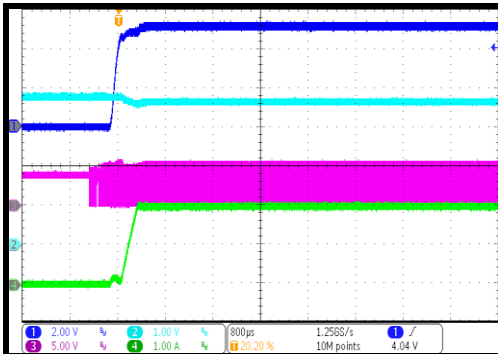

OTG Steady State Operation

V_{BATT} = 3.8V, V_{BOOST} = 5.15V, I_{OTG} = 2A

CH1: V_{IN}
CH3: SW
CH2: V_{BATT}
CH4: I_L

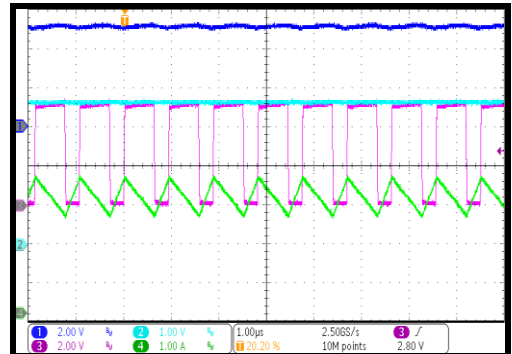

OPERATION

The MP2722 is a highly integrated, I²C-controlled, switch-mode battery charger IC with narrow-voltage DC (NVDC) power path management for the single-cell lithium-ion or lithium-polymer battery applications. The MP2722 integrates the reverse blocking MOSFET (RB-FET, Q_R), high-side switching MOSFET (HS-FET, Q_H), low-side switching MOSFET (LS-FET, Q_L), battery MOSFET (BATTFET, Q_B), and a USB Type-C 1.3 compliant, dual-role power (DRP), CC controller.

VCC Regulator

The VCC regulator is powered from the higher voltage between the BATT and PMID pins. The VCC pin requires an external 4.7μF bypass capacitor. The VCC pin provides power for the internal circuits and the gate drivers. When VCC pin voltage (V_{VCC}) exceeds the VCC under-voltage lockout (UVLO) threshold (V_{VCC_UV}), the I²C interface is ready for communication, and all of the registers are reset to their default values. The VCC pin can be used for external logic pull-up, but is not recommended for excess loads.

Battery Power-On

If an input source is not available, the battery is connected, and the battery voltage (V_{BATT}) exceeds the BATT UVLO threshold (V_{BATT_UV}), the BATTFET turns on and powers up the system. The low quiescent current and low voltage drop on BATTFET minimize battery consumption and maximize the battery runtime. The BATTFET's discharge current is monitored. If the system is overloaded or shorted to ground (I_{BATT} > I_{BATT_OCP}), the device turns off BATTFET immediately and sets the BATTFET_DIS bit to 1. The BATTFET can be re-enabled following the methods described in the Exiting Shipping Mode section on page 21.

Input Power-On

When an input source is plugged in, the IC detects the input source type and sets the input current limit (I_{IN_LIM}) before the buck converter starts. The start-up sequence from the input source is described in detail below:

1. The input voltage (V_{IN}) is detected.
2. The hold-off timer (about 250ms) runs.

3. Input source type detection starts.
4. I_{IN_LIM} is set.
5. If EN_BUCK = 1, the buck converter starts.
6. If EN_CHG = 1, charging starts.

Hold-Off Timer

When a valid input source is detected, the IC runs a hold-off timer (t_{HOLD}, typically about 250ms) before detecting the input source type. t_{HOLD} can be bypassed by setting HOLDOFF_TMR bit to 0.

Input Source Type Detection

The IC runs D+/D- detection when all of the following conditions are met:

- V_{IN} exceeds V_{IN_UV}
- V_{IN} is below V_{IN_OV}
- VIN_GD = 1
- t_{HOLD} ends
- AUTODPDM = 1, or FORCEDPDM is set

D+/D- detection includes the USB Battery Charging Specification 1.2 (BC1.2), non-standard adapter applications, and adjustable high-voltage adapter handshake. BC1.2 detection begins with data contact detection (DCD). If DCD detection is successful, the standard downstream port (SDP), dedicated charging port (DCP), and charging downstream port (CDP) are distinguished by primary and secondary detection. If the DCD timer expires, then non-standard adapter detection is initiated. Table 1 lists the criteria for non-standard adapter detection.

Table 1: Non-Standard Adaptor Detection

| Adaptor Type | D+ Voltage | D- Voltage |
|--------------|--|--|
| Divider 1 | V _{D+} within V _{2P0_TH} | V _{D-} within V _{2P7_TH} |
| Divider 2 | V _{D+} within V _{2P7_TH} | V _{D-} within V _{2P0_TH} |
| Divider 3 | V _{D+} within V _{2P7_TH} | V _{D-} within V _{2P7_TH} |
| Divider 4 | V _{D+} within V _{1P2_TH} | V _{D-} within V _{1P2_TH} |
| Divider 5 | V _{D+} within V _{2P7_TH} | V _{D-} > V _{2P7_TH} |

Once a DCP is detected, the device is ready to detect a high-voltage adapter. Once a high-voltage adapter is detected, DPDM_STAT is set to 1001, an INT pulse is generated, and the

device is ready to configure the D+/D- pins via register 0Bh.

If AUTODPDM = 0, then D+/D- detection is bypassed and the DPDM_STAT bits remain set to 0000.

Table 2 lists the I_{IN_LIM} settings from D+/D- detection.

Table 2: Input Current Limit Setting by D+/D- Detection

| D+/D- Detection | Input Current Limit |
|----------------------|---------------------|
| Not started | 500mA |
| USB SDP | 500mA |
| USB DCP | 2A |
| USB CDP | 1.5A |
| Divider 1 | 1A |
| Divider 2 | 2.1A |
| Divider 3 | 2.4A |
| Divider 4 | 2A |
| Divider 5 | 3A |
| Unknown | 500mA |
| High-voltage adapter | 2A |

USB Type-C Sink Detection

In USB Type-C sink mode, the CC1 and CC2 pins are connected to AGND via a 5.1kΩ resistor (R_d). The CC1 and CC2 voltages are monitored. The sink power sub-state is determined by the monitored CC pin voltage (see Table 3).

Table 3: USB-C Sink Power Sub-States by CC Voltage

| CC Detection Result | CC Voltage | Min | Max |
|---------------------|----------------------|-------|-------|
| Type-C default USB | vR _d -USB | 0.25V | 0.61V |
| Type-C 1.5A current | vR _d -1.5 | 0.70V | 1.16V |
| Type-C 3A Current | vR _d -3 | 1.31V | 2.04V |

Input Current Limit (I_{IN_LIM}) Setting

After input source type detection finishes, the following actions are executed:

- The CC1_SNK_STAT or CC2_SNK_STAT bits are updated
- The DPDM_STAT bits are updated
- I_{IN_LIM} is updated
- The VIN_RDY bit is set to 1

When the VIN_RDY bit is set, an INT pulse asserts and I_{IN_LIM} is updated (see Table 4). The host can overwrite the I_{IN_LIM} registers to modify I_{IN_LIM}.

Table 4: Input Current Limit Setting

| CC Detection Result | Input Current Limit |
|--|--|
| Type-C default USB or CC_CFG is disabled | D+/D- detection result (500mA if AUTODPDM = 0) |
| Type-C 1.5A current | 1.5A |
| Type-C 3A current | 3A |
| v _{Ra} (V _{IN} is present, but no voltage is detected on the CC pin) | 500mA |

If the monitored CC pin changes after the USB Type-C resistor (R_p) change debounce time (t_{RP_CHANGE}) (typically 15ms), then I_{IN_LIM} updates. An INT pulse follows this action.

If the FORCEDPDM bit is set to 1, then D+/D- detection restarts. Once D+/D- detection finishes, the DPDM_STAT bits and I_{IN_LIM} updates. An INT pulse follows this action.

Input Voltage Limit (V_{IN_LIM}) Setting

The MP2722 supports a configurable input voltage limit (V_{IN_LIM}). If V_{IN} drops to V_{IN_LIM} due to the input source capability or a cable voltage drop, then the duty cycle is limited to prevent V_{IN} from dropping further. This reduces the converter's total output current.

If the EN_VIN_TRK bit is set to 0, then the absolute V_{IN_LIM} is set by the VIN_LIM register. If the EN_VIN_TRK bit is set to 1, then V_{IN_LIM} is the maximum value between the VIN_LIM register's setting and (V_{BATT} + 165mV).

Buck Converter and Charger Start-Up

After the VIN_RDY bit is set to 1, the buck converter soft starts if EN_BUCK = 1. The buck converter's switching frequency (f_{sw}) can be set between 750kHz and 1.5MHz. Peak current mode control is adopted to regulate the system voltage (V_{sys}), battery charge current, battery regulation voltage (V_{BATT_REG}), I_{IN_LIM}, V_{IN_LIM}, and the device die temperature loops.

If the EN_CHG bit is set to 1, the device automatically starts charging.

NVDC Battery MOSFET (BATTFET)

Using the NVDC structure, the BATTFET separates the system from the battery and controls the battery charging and discharging.

With power path management, the device prioritizes the system (SYS) output by utilizing the input source, battery, or both.

When the input source is absent, the BATTFET turns fully on to pass the battery power to the system via the ultra-low impedance path. When the input source is present and the buck converter has started up, the system output is related to V_{BATT} in the following ways:

1. When V_{BATT} is below the minimum system voltage setting (V_{SYS_MIN}), V_{SYS} is regulated to $(V_{SYS_MIN} + V_{TRACK})$, where V_{TRACK} is typically 150mV. Depending on V_{BATT} , the BATTFET works in linear mode to charge the battery with a trickle-charge, pre-charge, or fast charge current.
2. Once V_{BATT} exceeds V_{SYS_MIN} , the BATTFET turns on fully and the voltage difference between V_{SYS} and V_{BATT} is the BATTFET resistive voltage drop.
3. When charging is disabled or terminated, V_{SYS} is always regulated to V_{TRACK} plus the higher value between V_{SYS_MIN} and V_{BATT} . In this scenario, V_{TRACK} is typically 100mV.

The status register $VSYS_STAT$ indicates whether the system is in V_{SYS_MIN} regulation.

Figure 3 shows V_{SYS} regulation as V_{BATT} changes.

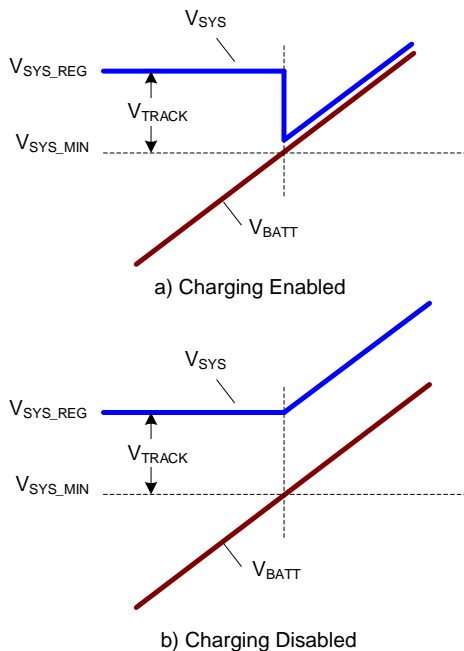

Figure 3: V_{SYS} Regulation with V_{BATT}

Dynamic Power Management

During the buck converter operation, the MP2722 continuously monitors the input current (I_{IN}) and V_{IN} . If I_{IN_LIM} or V_{IN_LIM} is reached, the charge current is reduced to prevent the input source from being overloaded.

If the charge current is reduced to 0A, V_{SYS} starts to drop due to input power limitation. Once the V_{SYS} falls below V_{BATT} , the IC automatically enters supplement mode.

If the converter operates in input current loop or input voltage loop, the $IINDPM_STAT$ or $VINDPM_STAT$ bit is set to 1, respectively. This is followed by a maskable INT pulse.

Supplement Mode

If V_{SYS} drops below V_{BATT} , the BATTFET turns on to prevent V_{SYS} from dropping further. In this scenario, the buck converter and the battery work together to provide power for the system.

Battery Charging

The MP2722 can autonomously run a charging cycle without host involvement. The host can also control the charge operations and parameters via the registers.

A new charge cycle starts when all of the below conditions are met:

- The buck converter has started up
- The NTC pin's (NTC1 and NTC2) voltages are within the acceptable ranges
- BATTFET is on ($BATTFET_DIS = 0$)
- Charging is enabled ($EN_CHG = 1$)

Charging Profile

The MP2722 detects V_{BATT} to provide four main charging phases: trickle-charge, pre-charge, constant-current charge, and constant-voltage charge (see Table 5).

Table 5: Charge Current Setting

| Battery Voltage (V_{BATT}) | Charge Current | Default Value | CHG_STAT |
|---|----------------|---------------|----------|
| $V_{BATT} < V_{BATT_TC}$ | $I_{TRICKLE}$ | 128mA | 001 |
| $V_{BATT_TC} \leq V_{BATT} < V_{BATT_PRE}$ | I_{PRE} | 240mA | 010 |
| $V_{BATT_PRE} \leq V_{BATT} < V_{BATT_REG}$ | I_{CC} | 2A | 011 |
| $V_{BATT} = V_{BATT_REG}$ | $<I_{CC}$ | - | 100 |

Throughout the charging process, the actual charge current may be below the register setting due to other regulation loops, such as the input current loop, input voltage loop, or thermal regulation. In this scenario, charge termination is blocked and the charge timer counts at half of its usual speed. Figure 4 shows the battery charging profile.

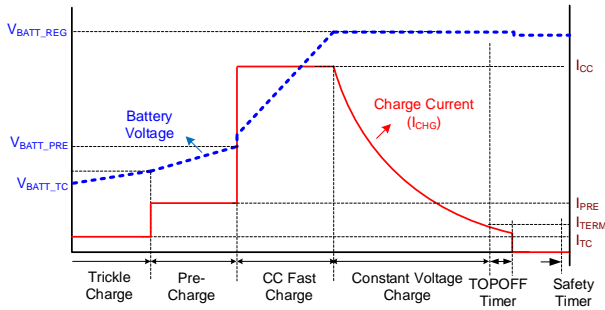

Figure 4: Battery Charging Profile

Charge Termination

If all the following conditions are met, charging is terminated:

- Termination is enabled ($EN_TERM = 1$)
- The charge current is below the termination threshold for t_{TERM_DGL} (about 250ms)
- The device is charging in the constant-voltage phase
- The device is not in an input current or input voltage loop
- The device is not in thermal regulation

After termination, the status register CHG_STAT is set to 101, the $STAT$ pin indicator goes high, and an INT pulse is generated.

To restart a new charge cycle once charging terminates, re-plug in the input source or toggle the EN_CHG bit.

To fully charge the battery, a top-off timer can be applied after termination is detected. The $TOPOFF_TIMER$ bits set the top-off timer. The $TOPOFF_ACTIVE$ bit is 1 when the top-off timer is active. A maskable INT pulse is generated when entering and exiting the top-off time. During top-off timer operation, charging continues, while the CHG_STAT bits and the $STAT$ pin both indicate that charging is done.

The top-off timer can be reset by any of the

conditions listed below:

- Charging changes from disabled to enabled
- Recharging begins
- The REG_RST bit is set

Automatic Recharge

When the battery is fully charged and charging is terminated, the battery may be discharged due to system supplement mode or self-discharge. When V_{BATT} discharges to the recharge threshold, the MP2722 automatically starts a new charging cycle without requiring a manual charge cycle restart, as long as the input power is valid. There is a deglitch timer (t_{RECH_DGL} , about 100ms) to detect whether V_{BATT} is below the recharge threshold. An INT pulse asserts when automatic recharging starts.

JEITA Thermistor Qualification

The device supports the JEITA profile to manage the charging parameters by continuously monitoring the $NTC1$ and $NTC2$ pin voltages. Two independent negative temperature coefficient (NTC) thermistors with temperature sensing and flexible configurations are provided. The $NTC1$ and $NTC2$ pins can be enabled and disabled by setting the $NTC1_ACTION$ and $NTC2_ACTION$ bit, respectively.

The EN_PG_NTC2 bit should be set to 1 to enable $NTC2$ channel. When EN_PG_NTC2 bit is set to 0, there is only one NTC monitor.

If the corresponding NTC channel is enabled, the voltage on the NTC pin must be within the V_{HOT} to V_{COLD} range to initiate a charge cycle. If the NTC pin voltage is outside the V_{HOT} to V_{COLD} range, then the MP2722 suspends charging and waits for the NTC voltage to return to the standard range.

In the cool temperature range (V_{COLD} to V_{COOL}), the charge current and/or charge voltage are reduced according to the $COOL_ACT$, $JEITA_ISET$, and $JEITA_VSET$ settings.

In the warm temperature range (V_{WARM} to V_{HOT}), the charge voltage and/or charge current are reduced according to the $WARM_ACT$, $JEITA_ISET$, and $JEITA_VSET$ settings.

The V_{COLD} , V_{COOL} , V_{WARM} , and V_{HOT} thresholds all have four configurable percentage levels.

The temperature conditions can be read in the NTC1_FAULT and/or NTC2_FAULT bits. An INT pulse is generated when NTC1 or NTC2 condition changes.

The NTC1 and NTC2 pins share the same configurable thresholds Table 6 shows the detection priority when the detection results between the two NTC inputs are different.

Table 6: JEITA Detection Priority

| NTC1 \ NTC2 | Hot | Warm | Normal | Cool | Cold |
|-------------|-----|------|--------|------|------|
| Hot | Hot | Hot | Hot | Hot | Hot |
| Warm | Hot | Warm | Warm | Warm | Cold |
| Normal | Hot | Warm | Normal | Cool | Cold |
| Cool | Hot | Warm | Cool | Cool | Cold |
| Cold | Hot | Cold | Cold | Cold | Cold |

For battery temperature protection during boost mode, if the NTC1_ACTION or NTC2_ACTION bit is set to 1, the device compares the NTC1 and/or NTC2 pin voltage with the V_{COLD} and V_{HOT} thresholds. If the NTC pin voltage is outside of V_{COLD} to V_{HOT} range, then boost mode is suspended. The NTC1_FAULT or NTC2_FAULT bit is also set to report the condition.

The preset hot, cold, warm, and cool voltage thresholds are defined for a β = 3435 thermistor. It is recommended to use a pull-up resistor with a value that matches the thermistor’s resistance at 25°C.

Figure 5 shows the JEITA voltage/current regulations with the following set-up: NTC1_ACTION = 1, NTC2_ACTION = 0, WARM_ACT = 01, COOL_ACT = 10, JEITA_VSET = 00, and JEITA_ISET = 00.

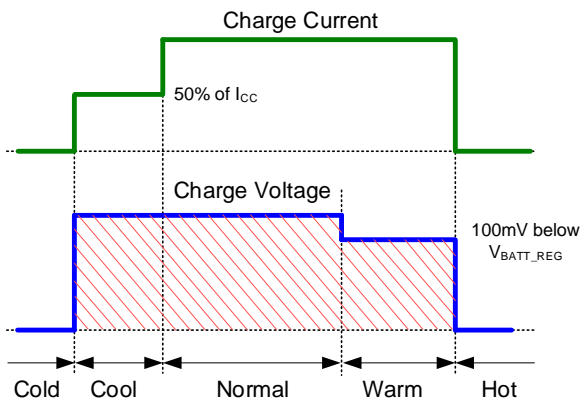

Figure 5: NTC Window under JEITA Control

Charging Safety Timer

The device has a built-in safety timer to prevent an extended charging cycle due to abnormal battery conditions. When V_{BATT} is below the V_{BATT_PRE} threshold, the safety timer is fixed to 2 hours. When V_{BATT} exceeds the V_{BATT_PRE} threshold, the safety timer is configured by CHG_TIMER bits. When the CHG_TIMER bits are set to 00, both the pre-charge timer and the fast-charge timer are disabled.

Charging is disabled after safety timer expires. Then the fault register’s CHG_FAULT bit is set to 10, and an INT pulse is generated.

During an input current, input voltage, thermal regulation or JEITA cool/warm condition (when charge current reduction is enabled), the charge timer counts at half of its usual rate. This halved clock rate function can be disabled by setting the EN_TMR2X bit to 0.

The charging safety timer resets if any of the following conditions are met:

- The input source is unplugged
- EN_BUCK or EN_CHG is toggled
- The REG_RST bit is set

Remote Battery Voltage Sense

To minimize the parasitic trace resistance during charging, the BATTSENS pin can be connected to the actual battery pack’s positive terminal. Remote sensing of the battery voltage accelerates the charging speed by helping the charger stay in constant-current charge mode for longer.

Shipping Mode

Entering Shipping Mode

When the host sets the BATTFET_DIS bit to 1, the MP2722 turns off the BATTFET immediately or after a delay time (t_{SHIP_DLY}), configured by the BATTFET_DLY bit.

Exiting Shipping Mode

When the MP2722 is in shipping mode (BATTFET_DIS = 1), either of the below events can wake up the BATTFET:

- An input source is applied
- The RST pin pulls low for t_{SHIPMODE}

BATTFET Reset

When the input source is absent, the system is powered by the battery through the BATTFET. The system can be forced to have a hardware power-on reset (POR) by changing the BATTFET status from on to off, then back to on.

For this function, the $\overline{\text{RST}}$ pin can be connected to the device's push-button. The $\overline{\text{RST}}$ pin is pulled up internally.

If the $\overline{\text{RST}}$ pin is driven low for t_{RST} while the input source is not plugged in and $\text{BATTFET_DIS} = 0$, the BATTFET turns off for $t_{\text{SYS_RST}}$, then it is enabled again (see Figure 6).

This function can be disabled by setting the BATTFET_RST_EN bit to 0.

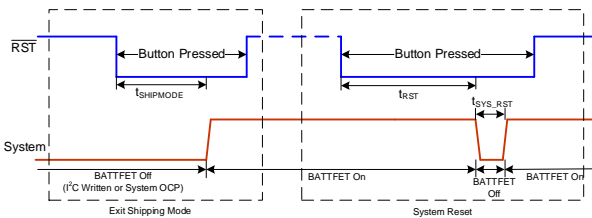

Figure 6: RST Timing

Power Good (PG) Indication

When EN_PG_NTC2 is set to 0, the PG/NTC2 pin acts as the power good (PG) indicator. This pin goes low to indicate a good input source when all of the following conditions are met:

- V_{IN} exceeds $V_{\text{IN_UV}}$
- V_{IN} is below $V_{\text{IN_OV}}$
- The 15ms debounce timer has passed

STAT and IB Indication

When the EN_STAT_IB bit is set to 0, the charging status is indicated on the open-drain STAT/IB pin (see Table 7).

Table 7: STAT Indication

| Charging State | STAT |
|--|---------------|
| Charging | Low |
| Charging is complete, top-off timer, boost mode, charging is disabled | High |
| Charging is suspended (due to battery OVP, input OVP, timer fault, or an NTC fault), boost mode is suspended (due to an NTC fault, OTP, or BATT_LOW) | Blinks at 1Hz |

When EN_STAT_IB is set to 1, the STAT/IB pin acts as an analog current source output that indicates the value of the battery current flowing in or out of the battery. The current's direction can be read via the BFET_STAT bit. Connect a resistor load between the STAT/IB pin and AGND to sense the IB current. If IB_EN is set to 1, the IB output is always on. If IB_EN is set to 0, the IB output is only on when the device is switching.

The IB output voltage is between 0V and V_{CC} . The host can measure the IB voltage to make a software fuel gauge or monitor the peak discharge current.

Interrupts (INT)

A 256 μs interrupt pulse is generated on the open-drain INT pin if any of the interrupt events occur. See the Interrupt List section on page 41 for more details.

Watchdog Functions (Bark and Bite)

After the first battery or V_{IN} start-up, the MP2722 operates with the default setup. The watchdog timer is expired by default when $\text{WATCHDOG_FAULT} = 1$. Writing 1 to WATCHDOG_RST starts the watchdog timer.

The watchdog timer has a bark function that generates an INT pulse when the watchdog timer is 3/4 of the way through its timer. The host can distinguish this condition by reading the WATCHDOG_BARK bit.

To maintain custom settings after the watchdog timer starts, write 1 to the WATCHDOG_RST bit before the watchdog timer expires. If the watchdog timer expires, the registers are reset according to the register table. After the watchdog timer expires, an INT pulse is sent and the WATCHDOG_FAULT bit is set to 1.

The watchdog timer can be disabled by setting the WATCHDOG bit to 00. If the watchdog timer is disabled, the registers keep their values until a POR.

Boost Mode

By boosting from the battery, the MP2722 is able to supply a regulated output at the IN pin. Boost mode starts once all of the following conditions are met:

- V_{IN} is below $V_{\text{IN_UV}}$

- The EN_BOOST bit is set to 1 by CC detection or by the host
- The voltages on the NTC pins (NTC1 and NTC2) are within the acceptable range
- V_{BATT} exceeds V_{BATT_UV}
- If BOOST_STP = 1, V_{BATT} must exceed V_{BATT_LOW}

The boost PWM's switching frequency is the same as the buck converter's setting.

The boost voltage loop regulates the PMID pin voltage at the value set by the VBOOST bits.

The boost output current loop limits the output current at the value set by the OLIM bits for the $V_{IN} > V_{BATT} + V_{HDMR}$ range.

The boost mode start-up sequence follows the steps below:

1. The converter soft starts and regulates the PMID voltage.
2. The blocking FET (Q_R) soft starts and regulates the discharge current from PMID to IN.
3. Once the IN pin starts up successfully, the boost is controlled to regulate the PMID voltage and the output current sensed through Q_R .

The boost converter's soft-start function allows the device to power into large capacitive loads on the IN pin.

USB Type-C Operation Modes

The MP2722 integrates a USB Type-C CC controller that supports multiple operation modes: sink-only, source-only, dual-role power (DRP), DRP with source preferred (try.SRC) and DRP with sink preferred (try.SNK). These operation modes can be configured with the CC_CFG bits. In addition to the modes being manually configurable, the MP2722 can function in any of the modes autonomously (without software intervention).

Sink Mode

The MP2722 can sink power from the input source, which presents R_d to AGND on the CC1 and CC2 pins. Set the CC_CFG bits to 000 to have the MP2722 act as a charger only, charging the battery once the input source is

detected by the IN pin.

The VIN_GD bit indicates whether a valid input source is detected. The CC1_SNK_STAT or CC2_SNK_STAT bits indicate the input source power advertisement.

Source Mode

Source mode is used for applications with the ability to start up external devices. The MP2722 can source power to the IN pin by boosting up from the battery. The device presents R_p pull-ups on the CC1 and CC2 pins. Set the CC_CFG bits to 001 to have the MP2722 generate a 5V output on the IN pin once a load is detected on either of the CC pins. The R_p value that advertises the source ability can be set via the RP_CFG bits.

The OTG_NEED bit indicates whether a valid external load is detected. The CC1_SRC_STAT or CC2_SRC_STAT bits can be read for the connection status on CC1 and CC2 pins.

DRP (Dual-Role Power) Mode

A DRP port can act as a sink or source. The MP2722 autonomously toggles between the sink (R_d) and source (R_p) on both the CC1 and CC2 pins for t_{DRP} (typically 80ms). t_{DRP} has a 50% duty cycle. The MP2722's role is determined automatically by the type of port plugged into it. The CC_CFG bits should be set to 010 for standard DRP mode.

In DRP mode, the same register bits and interrupts indicate the type of port that has been attached, as well as the source's power rating.

When the AUTOOTG is set to 1, the boost converter turns on/off via USB Type-C DRP detection, and the EN_BOOST bit is automatically updated. Writing 0 to the EN_BOOST bit can also turn off the boost converter during operation.

When the AUTOOTG bit is set to 0, the host turns the boost converter on/off by writing to the EN_BOOST bit. The host can determine the boost requirement with the OTG_NEED bit. This action is followed by an INT pulse.

Regardless of whether the MP2722 is operating in sink mode or source mode, the host can overwrite the EN_BOOST and/or EN_BUCK bit to turn the device on or off.

The debounced CC pin status can be read the in CC_SNK_STAT and CC_SRC_STAT bits. Any change in these bits is followed by a maskable INT pulse.

Forced Input Current Limit

When an input source is plugged in during sink mode, the MP2722 runs the start-up sequence and input source type detection. After detection finishes, I_{IN_LIM} is automatically generated. The I_{IN_LIM} result is returned by the IIN_LIM bits.

If the host does not want to use the automatically generated I_{IN_LIM} , there are two ways to set I_{IN_LIM} to different values via configuring either the IIN_MODE or IIN_LIM bits.

If the IIN_MODE bits are set to 000, the MP2722 runs with the automatically generated I_{IN_LIM} (returned by the IIN_LIM bits). However, once the VIN_RDY bit is set, the host can override the IIN_LIM bits to set I_{IN_LIM} to any value. This requires host involvement every time the converter starts up.

If the IIN_MODE bits are set to other values, I_{IN_LIM} is forced and fixed. For example, if the IIN_MODE bits are set to 101, the device always runs with a fixed 2000mA I_{IN_LIM} , ignoring the input source type detection.

Legacy Cable Detection

In sink mode, the MP2722 supports a legacy cable detection function. If the input source is plugged in through a Type-C to Type-C (C-C) cable, then V_{IN} is present after the CC1 and CC2 pins make contact for ≥ 100 ms. The adapter's Type-C port requires a debounce time ($t_{CC_DEBOUNCE}$) (between 100ms and 200ms) before it can turn on the V_{BUS} output. If a legacy Type-A to Type-C (A-C) cable is used, there is no debounce time.

A legacy cable timer (t_{LEGACY} , 75ms) starts once the CC1 or CC2 pin detects a vRd connect voltage ($>0.2V$). If an input source provides V_{BUS} before $t_{CC_DEBOUNCE}$ expires, or V_{IN} is present before the CC1 and CC2 pins make contact, then the LEGACYCABLE bit is set to 1 once a valid input source is detected (i.e. V_{IN} is between V_{IN_UV} and V_{IN_OV} after 15ms). This action is followed by a maskable an INT pulse. The LEGACYCABLE bit is reset to 0 if V_{IN} drops below V_{IN_UV} or exceeds V_{IN_OV} .

With legacy cable detection, the host can know the cable type. An advantage of this function is that if the legacy cable is non-compliant with the specification (e.g. if the CC pin is shorted to V_{BUS} or R_p is incorrect), the host can adjust the device's I_{IN_LIM} with the DPDM detection results.

Input Impedance Test

The MP2722 supports an input impedance testing function. By sourcing a current on the IN pin, the device can detect the impedance on the connector receptacle (water detection).

The host can write 1 to the VIN_SRC_EN bit to turn on the input impedance test by sourcing a current to the IN pin. The testing current can be configured via the IVIN_SRC bits. If V_{IN} rises to the threshold configured via the VIN_TEST bit, then VIN_TEST_HIGH is set to 1 and latched. This is followed by an INT pulse.

The host can write 0 to the VIN_SRC_EN bit to turn off the test current source and clear the VIN_TEST_HIGH bit.

The VIN_SRC_EN bit can only be effective when neither the buck nor boost is operating, and the current source's maximum pull-up voltage is 2.5V. If $V_{IN} > V_{IN_UV}$ is detected during the test, then the VIN_SRC_EN and VIN_TEST_HIGH bits are reset to 0 and the test ends immediately. If boost mode is enabled during the test, then the VIN_SRC_EN and VIN_TEST_HIGH bits are reset to 0 and the test ends immediately.

The advantage of the input impedance function is that the device can provide the information on the connector's impedance or moisture status. A Type-C connector can corrode when exposed to moisture, especially in source or DRP mode with a current on the CC pins. Software detects moisture conditions to allow the device to disable charging, the boost, or the Type-C block.

Lock Function

The MP2722 supports a lock function that limits the value of some key parameters (prevents accidental I²C writing). The battery regulation voltage, constant-current charge current, pre-charge current, and JEITA voltage/current settings are some of these parameters.

To enable the lock function, the host can set the above parameters to a target value, then write

the LOCK_CHG bit to 1. After these operations, these parameters can only be written to values below the previously set value.

Any of the following events can unlock the parameters:

- The host writes the LOCK_CHG bit to 0
- The host writes the REG_RST bit to 0
- The device shuts down

Protections

Battery Under-Voltage Protection (UVP)

If the battery is discharged below V_{BATT_UV} when the input source is absent, then the BATTFET turns off and all registers reset.

BATTFET Over-Current Protection (OCP)

The MP2722 monitors the BATTFET's current. If SYS is overloaded or experiences a short and the battery discharge current reaches the I_{BATT_OCP} threshold, then the BATTFET turns off and latches. In addition, the BATTFET_DIS bit is set to 1. To release the latch, apply one of the methods described in the Exiting Shipping Mode section on page 21.

Input Over-Voltage Protection (OVP)

The MP2722 provides input over-voltage protection (OVP) with a default rising threshold of 6.3V. If the IN pin senses a voltage above the V_{IN_OV} threshold, the buck converter stops working, the CHG_FAULT bits are set to 01, and an INT pulse is generated.

When V_{IN} returns to the normal range, the device runs the start-up sequence again and resumes normal operation. The CHG_FAULT bits are also cleared.

Battery Over-Voltage Protection (OVP)

The battery OVP threshold is 104% of V_{BATT_REG} . If a battery OV condition is detected, charging is disabled. Meanwhile, the fault register's CHG_FAULT bits are set to 11, and an INT pulse asserts.

Thermal Regulation and Thermal Shutdown

If the internal junction temperature reaches to the thermal regulation limit (T_{J_REG}) configured via the TREG bits (60°C to 120°C) during battery charging, then the charge current is reduced, charge termination is blocked, and the charge timer runs at half rate. The status

register's THERM_STAT bit is set to 1, followed by a maskable INT pulse.

If the internal junction temperature rises to the shutdown threshold (T_{J_SHDN} , about 150°C) at any time, both the converter and BATTFET turn off and all registers are reset. Once the junction temperature returns to T_{SHDN_HYS} (about 30°C) below T_{J_SHDN} (150°C), the MP2722 starts up again and resumes normal operation.

Boost Over-Voltage Protection (OVP)

If V_{IN} exceeds the regulation target and V_{BST_OVP} during boost operation, the device stops switching immediately. The BOOST_FAULT bits are set to 010, and an INT pulse is generated. Boost operation recovers once V_{IN} returns to its normal range.

Boost Overload Protection

If V_{IN} drops below the ($V_{BATT} + V_{HDMR}$) or V_{IN_UV} threshold due to a heavy load or short during boost operation, the blocking FET turns off and restarts after 500ms. If a total of 8 restarts are not successful, the boost converter stops and latches off. Then the BOOST_FAULT bits are set to 001 and an INT pulse is generated.

If the IN pin is shorted to GND before the boost converter starts, the blocking FET also restarts 8 times. If this is not successful, the boost converter stops and latches off.

Set the EN_BOOST bit to 0 to clear the BOOST_FAULT bits.

Boost Battery Low Protection

The MP2722 can protect the battery from being over-drained and prevent a system shutdown during boost operation. If the BOOST_STP_EN bit is set to 1 and V_{BATT} falls below the BATT_LOW setting, boost operation automatically turns off and the MP2722 latches. The BOOST_FAULT bits are set to 100 and generate a maskable INT pulse. The BATTFET continues operating to provide power to SYS.

The battery low comparator has a 10ms debounce time. Change the EN_BOOST bit to 0 to clear the BOOST_FAULT bits.

Boost Over-Temperature Protection

The MP2722 provides protection from over-temperature conditions in boost mode. If the BOOST_OTP_EN bit is set to 1 and the internal

junction temperature rises to the thermal regulation limit (T_{J_REG} , configured via the TREG bits), then boost operation stops and the MP2722 latches. The BOOST_FAULT bits are set to 011, followed by an INT pulse. In this scenario, the BATTFET continues operating to provide power to SYS.

Change the EN_BOOST bit to 0 to clear the BOOST_FAULT bits.

Serial Interface

The MP2722 uses an I²C-compatible interface to flexibly set charging parameters and instantaneously report the device status. The I²C is a two-wire serial interface with two required bus lines: a serial data line (SDA) and a serial clock line (SCL). Both the SDA and SCL lines are open drains that must be connected to the positive supply voltage with a pull-up resistor.

The IC operates as a slave device and receives control inputs from the master device, such as a microcontroller (MCU). The SCL line is always driven by the master device. The I²C interface supports both standard mode (up to 100kbps) and fast mode (up to 400kbps).

All transactions begin with a start (S) command and are terminated by a stop (P) command. Start and stop commands are always generated by the master. A start command is defined as a high-to-low transition on the SDA line while SCL is high. A stop command is defined as a low-to-high transition on the SDA line when the SCL is high (see Figure 7).

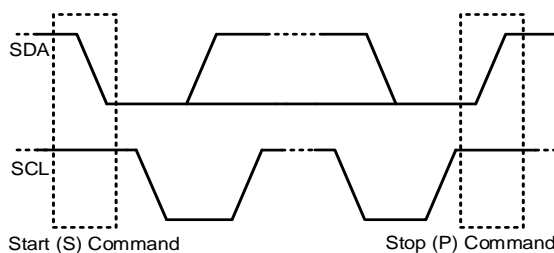

Figure 7: Start and Stop Commands

For data validity, the data on the SDA line must be stable during the high period of the clock.

The high or low state of the SDA line can only change when the clock signal on the SCL line is low (see Figure 8). Every byte on the SDA line must be 8 bits long. The number of bytes that can be transmitted per transfer is unrestricted. Data is transferred with the most significant bit (MSB) first.

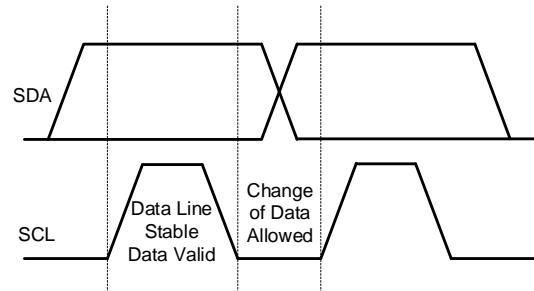

Figure 8: Bit Transfer on the I²C Bus

Each byte must be followed by an acknowledge (ACK) bit. The ACK bit is generated by the receiver to signal to the transmitter that the byte was successfully received.

The ACK signal is defined as when the transmitter releases the SDA line during the acknowledge clock pulse. This allows the receiver to pull the SDA line low, which remains low during the high period of the 9th clock pulse.

If the SDA line is high during the 9th clock pulse, this is considered a not acknowledge (NACK) signal. The master can then generate either a stop command to abort the transfer or a repeated start (Sr) command to start a new transfer.

A slave address is sent after the start command. This address is 7 bits long, followed by an 8th data direction bit (R/W). A 0 indicates a transmission (write), and a 1 indicates a request for data (read). Figure 9 shows the address bit arrangement.

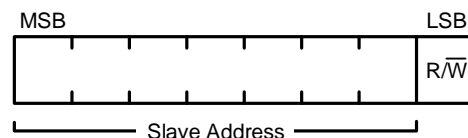

Figure 9: 7-Bit Addressing

Figure 10 shows a data transfer on the I²C bus.
 Figure 11 shows a single write sequence.
 Figure 12 shows a single read sequence.

Figure 13 shows a multi-write sequence. Figure 14 shows a multi-read sequence.

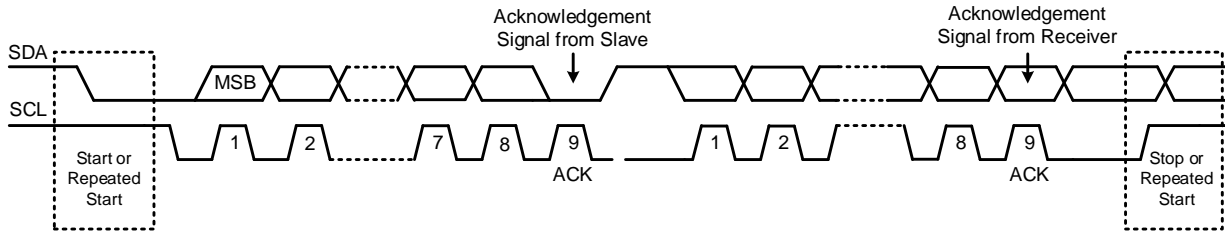

Figure 10: Data Transfer on the I²C Bus

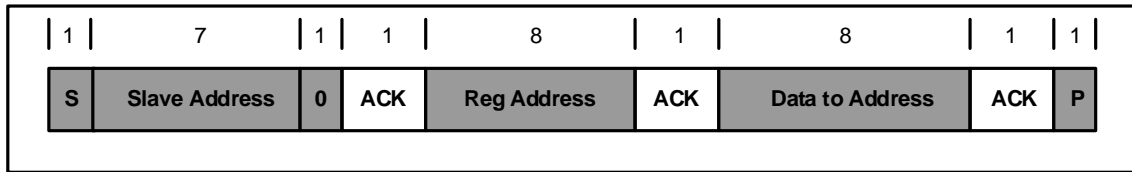

Figure 11: Single Write Sequence

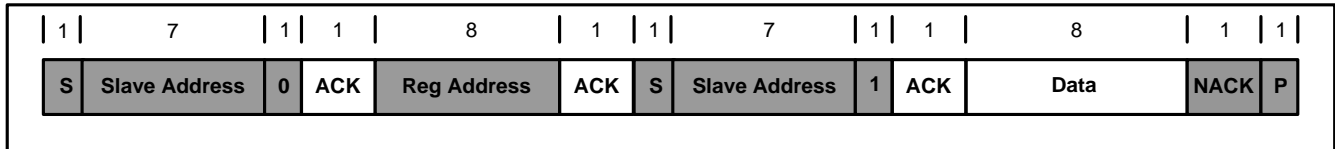

Figure 12: Single Read Sequence

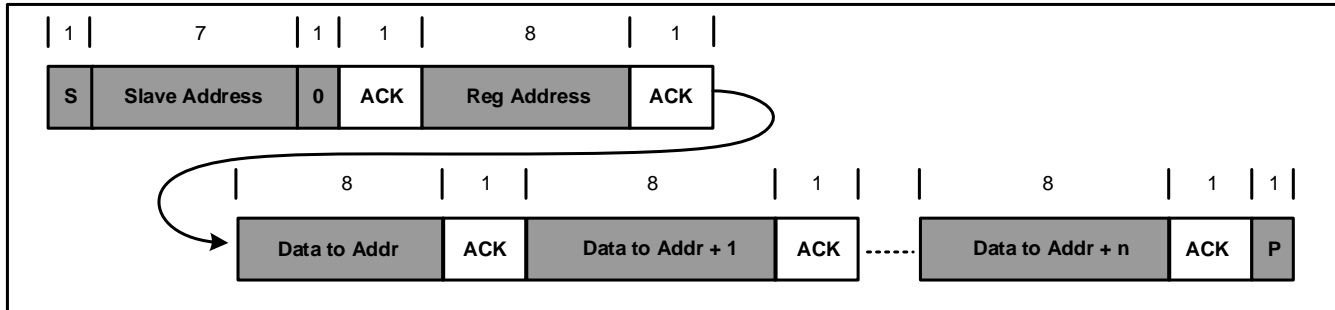

Figure 13: Multi-Write Sequence

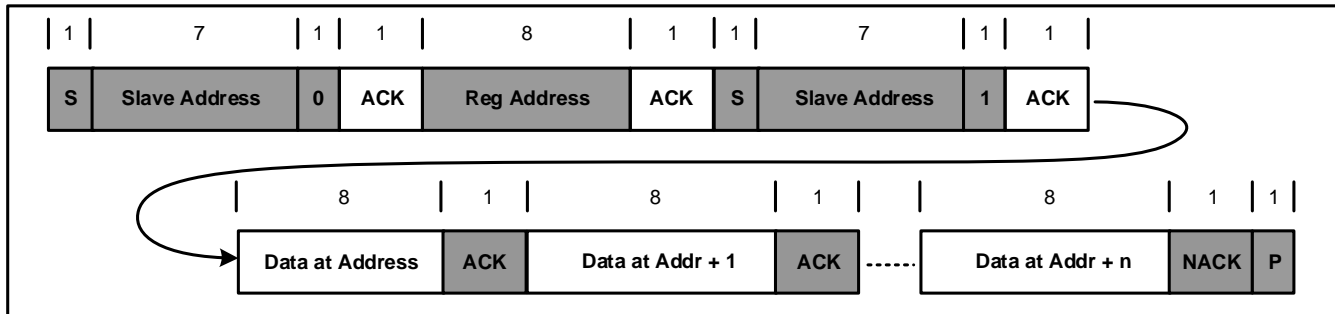

Figure 14: Multi-Read Sequence

REGISTER MAP

I²C Slave Address: 3Fh

Configuration Bytes: 00h~10h

Status Bytes: 11h~16h

CONFIGURATION BYTES (00h~10h)

Legend: POR = default value; WTD = watchdog; R/W = read/write; R = read-only, OTP-configurable = the register's default value can be configured via the OTP

REG00h

| Bit | Name | POR | WTD Reset | Type | Description | Comment |
|-----|-------------|-----|-----------|------|---|---|
| 7 | REG_RST | 0 | - | R/W | Resets the register. 0: Keep the current setting 1: Reset the registers to their default values | This bit returns to 0 after it is written to 1. |
| 6 | EN_STAT_IB | 0 | No | R/W | 0: The STAT/IB pin is configured as an open-drain status indicator (STAT) 1: The STAT/IB pin is configured as a battery current indicator (IB) | OTP-configurable. |
| 5 | EN_PG_NTC2 | 0 | No | R/W | 0: The PG/NTC2 pin is configured as an open-drain power good indicator (PG) 1: The PG/NTC2 pin is configured as a second thermistor input (NTC2) | To enable the NTC2 channel, this bit must be set to 1. OTP-configurable. |
| 4 | LOCK_CHG | 0 | No | R/W | 0: Not locked 1: The VBATT[5:0], ICC[5:0], IPRE[3:0], JEITA_VSET[1:0], and JEITA_ISET[1:0] values are locked | After this bit is set to 1, any future writes to VBATT[5:0], ICC[5:0], IPRE[3:0], JEITA_VSET[1:0], and JEITA_ISET[1:0] can only reduce the set values. |
| 3 | HOLDOFF_TMR | 1 | Yes | R/W | 0: Disable the hold-off timer 1: Enable the hold-off timer | OTP-configurable. |
| 2 | SW_FREQ[1] | 0 | No | R/W | 00: 750kHz 01: 1MHz 10: 1.25MHz 11: 1.5MHz | Configures both the buck and boost operating frequencies. Default: 1MHz (01) OTP-configurable. |
| 1 | SW_FREQ[0] | 1 | No | R/W | | |
| 0 | EN_VIN_TRK | 1 | No | R/W | 0: V _{IN_LIM} is fixed 1: V _{IN_LIM} also tracks V _{BATT} | When this bit is set to 0, the V _{IN_LIM} register sets the absolute input voltage limit (V _{IN_LIM}) value. When this bit is set to 1, V _{IN_LIM} is the maximum value between V _{IN_LIM} [3:0] and (V _{BATT} + 165mV). |

REG01h

| Bit | Name | POR | WTD Reset | Type | Description | Comment |
|-----|-------------|-----|-----------|------|--|--|
| 7 | IIN_MODE[2] | 0 | No | R/W | 000: Follow the IIN_LIM setting 001: Force I _{IN_LIM} to 100mA 010: Force I _{IN_LIM} to 500mA 011: Force I _{IN_LIM} to 900mA 100: Force I _{IN_LIM} to 1500mA 101: Force I _{IN_LIM} to 2000mA 110: Force I _{IN_LIM} to 3000mA | When setting these bits to 000, the input current limit (I _{IN_LIM}) follows the automatically generated I _{IN_LIM} value in IIN_LIM[4:0]. When setting these bits to other values, I _{IN_LIM} is fixed. Default: 000 OTP-configurable. |
| 6 | IIN_MODE[1] | 0 | No | R/W | | |
| 5 | IIN_MODE[0] | 0 | No | R/W | | |
| 4 | IIN_LIM[4] | 0 | No | R/W | 1600mA. | Sets I _{IN_LIM} . Range: 100mA to 3.2A Offset: 100mA Default: 500mA (00100) This is automatically updated after input source type detection. The host can overwrite the I _{IN_LIM} value. |
| 3 | IIN_LIM[3] | 0 | No | R/W | 800mA. | |
| 2 | IIN_LIM[2] | 1 | No | R/W | 400mA. | |
| 1 | IIN_LIM[1] | 0 | No | R/W | 200mA. | |
| 0 | IIN_LIM[0] | 0 | No | R/W | 100mA. | |

REG02h

| Bit | Name | POR | WTD Reset | Type | Description | Comment |
|-----|---------|-----|-----------|------|--|---|
| 7 | VPRE[1] | 1 | No | R/W | 00: 2.4V 01: 2.6V 10: 2.8V 11: 3V | Sets the pre-charge to fast charge battery voltage threshold. Default: 3V (11) |
| 6 | VPRE[0] | 1 | No | R/W | | |
| 5 | ICC[5] | 0 | Yes | R/W | 2560mA. | Sets the fast charge current. Default: 2A (011001) OTP-configurable. |
| 4 | ICC[4] | 1 | Yes | R/W | 1280mA. | |
| 3 | ICC[3] | 1 | Yes | R/W | 640mA. | |
| 2 | ICC[2] | 0 | Yes | R/W | 320mA. | |
| 1 | ICC[1] | 0 | Yes | R/W | 160mA. | |
| 0 | ICC[0] | 1 | Yes | R/W | 80mA. | |

REG03h

| Bit | Name | POR | WTD Reset | Type | Description | Comment |
|-----|----------|-----|-----------|------|-------------|---|
| 7 | IPRE[3] | 0 | Yes | R/W | 320mA. | Sets the pre-charge current Range: 80mA to 680mA Offset: 80mA Default: 240mA (0100) OTP-configurable. |
| 6 | IPRE[2] | 1 | Yes | R/W | 160mA. | |
| 5 | IPRE[1] | 0 | Yes | R/W | 80mA. | |
| 4 | IPRE[0] | 0 | Yes | R/W | 40mA. | |
| 3 | ITERM[3] | 0 | Yes | R/W | 240mA. | Sets the termination current. Range: 30mA to 480mA Offset: 30mA Default: 120mA (0011) OTP-configurable. |
| 2 | ITERM[2] | 0 | Yes | R/W | 120mA. | |
| 1 | ITERM[1] | 1 | Yes | R/W | 60mA. | |
| 0 | ITERM[0] | 1 | Yes | R/W | 30mA. | |

REG04h

| Bit | Name | POR | WTD Reset | Type | Description | Comment |
|-----|-------------|-----|-----------|------|----------------------|---|
| 7 | VRECHG | 0 | Yes | R/W | 0: 100mV 1: 200mV | Sets the recharge threshold. Default: 100mV |
| 6 | ITRICKLE[2] | 0 | Yes | R/W | 128mA. | Sets the trickle charge current. Range: 32mA to 256mA Offset: 32mA Default: 128mA (011) OTP-configurable. |
| 5 | ITRICKLE[1] | 1 | Yes | R/W | 64mA. | |
| 4 | ITRICKLE[0] | 1 | Yes | R/W | 32mA. | |
| 3 | VIN_LIM[3] | 0 | No | R/W | 640mV. | Input voltage limit threshold Range: 3.88V to 5.08V Offset: 3.88V Default: 4.36V (0110) |
| 2 | VIN_LIM[2] | 1 | No | R/W | 320mV. | |
| 1 | VIN_LIM[1] | 1 | No | R/W | 160mV. | |
| 0 | VIN_LIM[0] | 0 | No | R/W | 80mV. | |

REG05h

| Bit | Name | POR | WTD Reset | Type | Description | Comment |
|-----|---------------|-----|-----------|------|--|---|
| 7 | TOPOFF_TMR[1] | 0 | Yes | R/W | 00: Disabled 01: 15 minutes 10: 30 minutes 11: 45 minutes | Timer to stop charging after charge termination. |
| 6 | TOPOFF_TMR[0] | 0 | Yes | R/W | | |
| 5 | VBATT[5] | 0 | No | R/W | 800mV. | Sets the battery regulation voltage (V _{BATT_REG}). Values above 101000 (4.6V) are clamped to 101000. Range: 3.6V to 4.6V Offset: 3.6V Default: 4.2V (011000) OTP-configurable. |
| 4 | VBATT[4] | 1 | No | R/W | 400mV. | |
| 3 | VBATT[3] | 1 | No | R/W | 200mV. | |
| 2 | VBATT[2] | 0 | No | R/W | 100mV. | |
| 1 | VBATT[1] | 0 | No | R/W | 50mV. | |
| 0 | VBATT[0] | 0 | No | R/W | 25mV. | |

REG06h

| Bit | Name | POR | WTD Reset | Type | Description | Comment |
|-----|------------|-----|-----------|------|--|---|
| 7 | VIN_OVP[1] | 0 | No | R/W | 00: 6.3V 01: 11V 10: 14V 11: Disabled | Sets the input over-voltage protection (OVP) threshold. Default: 6.3V (00) OTP-configurable. |
| 6 | VIN_OVP[0] | 0 | No | R/W | | |
| 5 | SYS_MIN[2] | 1 | No | R/W | 000: 2.975V 001: 3.15V 010: 3.325V 011: 3.5V 100: 3.588V 101: 3.675V 110: 3.763V | Sets the system minimum regulation voltage (V _{sys_min}). Default: 3.588V (100) The actual system regulation voltage is this value plus V _{TRACK} =150mV OTP-configurable. |
| 4 | SYS_MIN[1] | 0 | No | R/W | | |
| 3 | SYS_MIN[0] | 0 | No | R/W | | |
| 2 | TREG[2] | 1 | Yes | R/W | 000: 60°C 001: 70°C 010: 80°C 011: 90°C 100: 100°C 101: 110°C 110: 120°C | Sets the thermal regulation threshold for charge mode, as well as the thermal protection threshold for boost mode. Default: 100°C (100) |
| 1 | TREG[1] | 0 | Yes | R/W | | |
| 0 | TREG[0] | 0 | Yes | R/W | | |

REG07h

| Bit | Name | POR | WTD Reset | Type | Description | Comment |
|-----|--------------|-----|-----------|------|---|---|
| 7 | IB_EN | 0 | Yes | R/W | 0: IB outputs when the switcher is on 1: IB outputs all the time | Enables IB when only the battery is present, which uses about 3μA of battery current. Default: 0 |
| 6 | WATCHDOG_RST | 0 | - | R/W | 1: Reset the watchdog timer | After writing this bit to 1, the watchdog timer is reset, and this bit returns to 0. |
| 5 | WATCHDOG[1] | 0 | Yes | R/W | 00: Disable timer 01: 40s 10: 80s 11: 160s | Default: 40s (01) OTP-configurable. |
| 4 | WATCHDOG[0] | 1 | Yes | R/W | | |
| 3 | EN_TERM | 1 | Yes | R/W | 0: Disable termination 1: Enable termination | Default: Enable termination (1) |
| 2 | EN_TMR2X | 1 | Yes | R/W | 0: Disable 2x timer 1: Enable 2x timer | Default: Enable 2x timer (1) |
| 1 | CHG_TIMER[1] | 1 | Yes | R/W | 00: Disable timer 01: 5hrs 10: 10hrs 11: 15hrs | Sets the charge safety timer. Default: 10hrs (10) |
| 0 | CHG_TIMER[0] | 0 | Yes | R/W | | |

REG08h

| Bit | Name | POR | WTD Reset | Type | Description | Comment |
|-----|----------------|-----|-----------|------|--|--|
| 7 | BATTFET_DIS | 0 | No | R/W | 0: Allow BATTFET to remain on 1: Turn off BATTFET | Shipping mode or OCP |
| 6 | BATTFET_DLY | 1 | No | R/W | 0: Turn off BATTFET immediately 1: Turn off BATTFET after a 10s delay | Sets the delay after BATTFET_DIS is set to 1. Default: Turn off BATTFET after a 10s delay (1) |
| 5 | BATTFET_RST_EN | 1 | Yes | R/W | 0: Disable the BATTFET reset function 1: Enable BATTFET reset function | Default: Enable the BATTFET reset function (1) |
| 4 | OLIM[1] | 1 | Yes | R/W | 00: 500mA 01: 1.5A 10: 2.1A 11: 3A | Sets the boost output current limit. Default: 3A (11) |
| 3 | OLIM[0] | 1 | Yes | R/W | | |
| 2 | VBOOST[2] | 1 | No | R/W | 011: 5.35V 010: 5.3V 001: 5.25V 000: 5.2V 111: 5.15V 110: 5.1V 101: 5.05V 100: 5V | Sets the boost output voltage. Default: 5.15V (111) OTP-configurable. |
| 1 | VBOOST[1] | 1 | No | R/W | | |
| 0 | VBOOST[0] | 1 | No | R/W | | |

REG09h

| Bit | Name | POR | WTD Reset | Type | Description | Comment |
|-----|-----------|-----|-----------|------|---|---|
| 7 | Reserved | 0 | No | R | | |
| 6 | CC_CFG[2] | 0 | Yes | R/W | 000: Sink only 001: Source only 010: DRP 011: DRP with Try.SNK 100: DRP with Try.SRC 101: Disabled | When the mode changes, the device resets to Unattached.SNK. Default: Sink only (000) OTP-configurable. |
| 5 | CC_CFG[1] | 0 | Yes | R/W | | |
| 4 | CC_CFG[0] | 0 | Yes | R/W | | |
| 3 | AUTOOTG | 1 | Yes | R/W | | |
| 2 | EN_BOOST | 0 | Yes | R/W | 0: Boost disabled 1: Boost enabled | When AUTOOTG = 1, the EN_BOOST bit is set/reset automatically, and boost mode is enabled/disabled. Writing 0 to EN_BOOST also turns off boost mode. When AUTOOTG = 0, the host can determine the boost requirement with the OTG_NEED bit. Writing 0 to EN_BOOST disables boost mode; writing 1 to EN_BOOST enables boost mode. |
| 1 | EN_BUCK | 1 | Yes | R/W | 0: Buck disabled 1: Buck allowed | Set this bit to 0 to force the buck converter off. |
| 0 | EN_CHG | 1 | Yes | R/W | 0: Charging disable 1: Charging allowed | Set this bit to 0 to force charging off. |

REG0Ah

| Bit | Name | POR | WTD Reset | Type | Description | Comment |
|-----|-------------|-----|-----------|------|--|--|
| 7 | RESERVED | 0 | No | R | Reserved. | |
| 6 | RESERVED | 0 | No | R | Reserved. | |
| 5 | AUTODPDM | 1 | Yes | R/W | 0: D+/D- detection starts manually 1: D+/D- detection automatically starts after VIN_GD = 1 and the hold-off timer ends | Default: 1 OTP-configurable. |
| 4 | FORCEDPDM | 0 | - | R/W | 0: Normal 1: Force D+/D- detection | This bit returns to 0 after 1 written |
| 3 | RP_CFG[1] | 0 | Yes | R/W | 00: 80µA default USB 01: 180µA, USB Type-C 1.5A 10: 330µA, USB Type-C 3A | Sets the current rating advertisement in boost mode. Default: 01 OTP-configurable. |
| 2 | RP_CFG[0] | 1 | Yes | R/W | | |
| 1 | FORCE_CC[1] | 0 | Yes | R/W | 00: The CC1 and CC2 pins are automatically configured via CC_CFG 01: Forces the CC1 and CC2 pins to Rd 10: Forces the CC1 and CC2 pins to Rp (set by RP_CFG) 11: Forces the CC1 and CC2 pins into a high-impedance (Hi-Z) state | Default: 00 OTP-configurable. |
| 0 | FORCE_CC[0] | 0 | Yes | R/W | | |

REG0Bh

| Bit | Name | POR | WTD Reset | Type | Description | Comment |
|-----|----------|-----|-----------|------|--|---|
| 7 | RESERVED | 0 | No | R | Reserved. | |
| 6 | RESERVED | 0 | No | R | Reserved. | |
| 5 | RESERVED | 0 | No | R | Reserved. | |
| 4 | HVEN | 1 | No | R/W | 0: Disables high-voltage adapter detection 1: Enables high-voltage adapter detection | Default: 1 OTP |
| 3 | HVUP | 0 | - | R/W | 0: DP and DM do not change 1: DP = DM = 3.3V for 500µs | HVUP is only functional when DPDM_STAT = 1001 and HVREQ[1:0] = 11. This bit returns to 0 after being written to 1. |
| 2 | HVDOWN | 0 | X | R/W | 0: DP DM unchanged 1: DP = DM = 0.6V for 500µs | HVDOWN is only functional when DPDM_STAT = 1001 and HVREQ[1:0] = 11. This bit returns to 0 after being written to 1. |
| 1 | HVREQ[1] | 0 | Y | R/W | 00: DP = 0.6V, DM = Hi-Z 01: DP = 3.3V, DM = 0.6V 10: DP = 0.6V, DM = 0.6V 11: DP = 0.6V, DM = 3.3V | HVREQ is only functional when DPDM_STAT = 1001. This bit is reset to 00 once VIN_GD = 0. |
| 0 | HVREQ[0] | 0 | Y | R/W | | |

REG0Ch

| Bit | Name | POR | WTD Reset | Type | Description | Comment |
|-----|--------------|-----|-----------|------|---|---|
| 7 | RESERVED | 0 | No | R | Reserved. | |
| 6 | NTC1_ACTION | 1 | No | R/W | 0: Only generate INT when the NTC1 status changes 1: NTC1 is fully functional | The buck converter is not affected by this bit. Default: 1 OTP |
| 5 | NTC2_ACTION | 0 | No | R/W | 0: Only generate INT when the NTC2 status changes 1: NTC2 is fully functional | The buck converter is not affected by this bit. Default: 0 OTP-configurable. |
| 4 | BATT_OVP_EN | 1 | Yes | R/W | 0: Battery OVP is neglected 1: Battery OVP is enabled | Default: 1 |
| 3 | BATT_LOW[1] | 0 | No | R/W | 00: 3V falling 01: 3.1V falling 10: 3.2V falling 11: 3.3V falling | If V _{BATT} drops below BATT_LOW, an INT pulse is generated with a 10ms debounce time. Default: 3V (00) |
| 2 | BATT_LOW[0] | 0 | No | R/W | | |
| 1 | BOOST_STP_EN | 0 | Yes | R/W | 0: The BATT_LOW comparator only generates INT 1: The BATT_LOW comparator turns off boost operation and latches | Default: 0 OTP-configurable. |
| 0 | BOOST_OTP_EN | 1 | Yes | R/W | 0: Boost OTP is ignored 1: Boost OTP occurs at TREG | Default: 1 OTP-configurable. |

REG0Dh

| Bit | Name | POR | WTD Reset | Type | Description | Comment |
|-----|---------------|-----|-----------|------|--|--|
| 7 | WARM_ACT[1] | 0 | No | R/W | 00: No action during an NTC warm condition 01: Reduce V _{BATT_REG} during an NTC warm condition 10: Reduce I _{CC} during an NTC warm condition 11: Reduce both V _{BATT_REG} and I _{CC} during an NTC warm condition | If both the NTC1_ACTION and NTC2_ACTION bits are set to 1, see Table 6 on page 21 for more details. Default: 01 |
| 6 | WARM_ACT[0] | 1 | No | R/W | | |
| 5 | COOL_ACT[1] | 1 | No | R/W | 00: No action during an NTC cool condition 01: Reduce V _{BATT_REG} during an NTC cool condition 10: Reduce I _{CC} during an NTC cool condition 11: Reduce both V _{BATT_REG} and I _{CC} during an NTC cool condition | If both the NTC1_ACTION and NTC2_ACTION bits are set to 1, see Table 6 on page 21 for more details. Default: 10 |
| 4 | COOL_ACT[0] | 0 | No | R/W | | |
| 3 | JEITA_VSET[1] | 0 | Yes | R/W | 00: V _{BATT_REG} - 100mV 01: V _{BATT_REG} - 150mV 10: V _{BATT_REG} - 200mV 11: V _{BATT_REG} - 250mV | Default: 00 |
| 2 | JEITA_VSET[0] | 0 | Yes | R/W | | |
| 1 | JEITA_ISET[1] | 0 | Yes | R/W | 00: 50% of I _{CC} 01: 33% of I _{CC} 10: 20% of I _{CC} | Default: 00 |
| 0 | JEITA_ISET[0] | 0 | Yes | R/W | | |

REG0Eh

| Bits | Name | POR | WTD Reset | Type | Description | Comment |
|------|----------|-----|-----------|------|---------------------------------------|---|
| 7 | VHOT[1] | 1 | Yes | R/W | 00: 29.1% (50°C) 01: 25.9% (55°C) | Sets the hot falling threshold, as a percentage of V _{VRNTC} . Default: 23% (10) |
| 6 | VHOT[0] | 0 | Yes | R/W | 10: 23% (60°C) 11: 20.4% (65°C) | |
| 5 | VWARM[1] | 0 | Yes | R/W | 00: 36.5% (40°C) 01: 32.6% (45°C) | Sets the warm falling threshold, as a percentage of V _{VRNTC} . Default: 32.6% (01) |
| 4 | VWARM[0] | 1 | Yes | R/W | 10: 29.1% (50°C) 11: 25.9% (55°C) | |
| 3 | VCOOL[1] | 1 | Yes | R/W | 00: 74.2% (0°C) 01: 69.6% (5°C) | Sets the cool rising threshold, as a percentage of V _{VRNTC} . Default: 64.8% (10) |
| 2 | VCOOL[0] | 0 | Yes | R/W | 10: 64.8% (10°C) 11: 59.9% (15°C) | |
| 1 | VCOLD[1] | 0 | Yes | R/W | 00: 78.4% (-5°C) 01: 74.2% (0°C) | Sets the cold rising threshold, as a percentage of V _{VRNTC} . Default: 74.2% (01) |
| 0 | VCOLD[0] | 1 | Yes | R/W | 10: 69.6% (+5°C) 11: 64.8% (+10°C) | |

REG0Fh

| Bit | Name | POR | WTD Reset | Type | Description | Comment |
|-----|-------------|-----|-----------|------|---|---|
| 7 | RESERVED | 0 | No | R | Reserved. | |
| 6 | VIN_SRC_EN | 0 | Yes | R/W | 0: Normal 1: Source current to the IN pin | Enables the input impedance test. |
| 5 | IVIN_SRC[3] | 0 | Yes | R/W | 0000: 5μA 0001: 10μA | Configures the input impedance test current source. |
| 4 | IVIN_SRC[2] | 0 | Yes | R/W | 0010: 20μA 0011: 40μA | |
| 3 | IVIN_SRC[1] | 0 | Yes | R/W | 0100: 80μA 0101: 160μA 0110: 320μA 0111: 640μA | |
| 2 | IVIN_SRC[0] | 0 | Yes | R/W | 1000: 1280μA | |
| 1 | VIN_TEST[1] | 0 | Yes | R/W | 00: 0.3V 01: 0.5V | Configures the input impedance test comparator threshold. |
| 0 | VIN_TEST[0] | 0 | Yes | R/W | 10: 1V 11: 1.5V | |

REG10h

| Bits | Name | POR | WTD Reset | Type | Description | Comment |
|------|------------------|-----|-----------|------|--|-------------------|
| 7 | RESERVED | 0 | No | R | Reserved. | |
| 6 | RESERVED | 1 | No | R | Reserved. | |
| 5 | MASK_THERM | 0 | No | R/W | 0: Enable the THERM_STAT INT pulse 1: Mask the THERM_STAT INT pulse | OTP-configurable. |
| 4 | MASK_DPM | 0 | No | R/W | 0: Enable the VINDPM and IINDPM INT pulses 1: Mask the VINDPM and IINDPM INT pulses | |
| 3 | MASK_TOPOFF | 0 | No | R/W | 0: Enable the TOPOFF timer INT pulse 1: Mask the TOPOFF timer INT pulse | |
| 2 | MASK_CC_INT | 0 | No | R/W | 0: Enable the CC_SNK and CC_SRC INT pulses 1: Mask the CC_SNK and CC_SRC INT pulse | OTP-configurable. |
| 1 | MASK_BATT_LOW | 0 | No | R/W | 0: Enable the BATT_LOW INT pulse 1: Mask the BATT_LOW INT pulse | |
| 0 | MASK_DEBUG_AUDIO | 0 | No | R/W | 0: Allow DEBUGACC and AUDIOACC INT pulse 1: Mask DEBUGACC and AUDIOACC INT pulse | |

STATUS BYTES (11h~16h)

Legend: POR = default value; R/W = read/write; R = read-only; INT = interrupt; YM = the interrupt can be masked

REG11h

| Bits | Name | POR | R/W | INT | Description |
|------|--------------|-----|-----|-----|--|
| 7 | DPDM_STAT[3] | - | R | No | Returns the input source D+/D- detection result. |
| 6 | DPDM_STAT[2] | - | R | No | 0000: Not started (500mA) 0001: USB SDP (500mA) 0010: USB DCP (2A) 0011: USB CDP (1.5A) |
| 5 | DPDM_STAT[1] | - | R | No | 0100: Divider 1 (1A) 0101: Divider 2 (2.1A) 0110: Divider 3 (2.4A) 0111: Divider 4 (2A) |
| 4 | DPDM_STAT[0] | - | R | No | 1000: Unknown (500mA) 1001: High-voltage adapter (2A) 1110: Divider 5 (3A) |
| 3 | RESERVED | - | R | No | Reserved. |
| 2 | RESERVED | - | R | No | Reserved. |
| 1 | VINDPM_STAT | - | R | YM | 0: Not in VINDPM 1: In VINDPM |
| 0 | IINDPM_STAT | - | R | YM | 0: Not in IINDPM 1: In IINDPM |

REG12h

| Bits | Name | POR | R/W | INT | Description |
|------|----------------|-----|-----|-----|--|
| 7 | RESERVED | - | R | No | Reserved. |
| 6 | VIN_GD | - | R | Yes | When $V_{VIN_UV} < V_{IN} < V_{VIN_OV}$ in buck mode, this bit is set to 1 and the PG pin is driven low (after a 15ms debounce time). 0: The input source is not valid 1: The input source is good |
| 5 | VIN_RDY | - | R | Yes | Indicates whether input source type detection has finished. IIN_LIM[4:0] is updated. 0: V_{IN} is not ready to charge 1: V_{IN} is ready to charge |
| 4 | LEGACYCABLE | - | R | YM | 0: Normal 1: Legacy cable is detected (not valid in DRP mode) |
| 3 | THERM_STAT | - | R | YM | 0: Not in thermal regulation 1: In thermal regulation |
| 2 | VSYS_STAT | - | R | No | 0: $V_{BATT} < V_{SYS_MIN}$ 1: $V_{BATT} > V_{SYS_MIN}$ |
| 1 | WATCHDOG_FAULT | - | R | Yes | 0: Normal 1: The watchdog timer has expired |
| 0 | WATCHDOG_BARK | - | R | Yes | 0: Normal 1: The 3/4 watchdog timer has expired |

REG13h

| Bits | Name | POR | R/W | INT | Description |
|------|----------------|-----|-----|-----|--|
| 7 | CHG_STAT[2] | - | R | No | 000: Not charging 001: Trickle charge |
| 6 | CHG_STAT[1] | - | R | No | 010: Pre-charge 011: Fast charge |
| 5 | CHG_STAT[0] | - | R | No | 100: Constant-voltage charge 101: Charging is done |
| 4 | BOOST_FAULT[2] | - | R | Yes | 000: Normal 001: An IN overload or short (latch-off) has occurred |
| 3 | BOOST_FAULT[1] | - | R | Yes | 010: Boost over-voltage protection (OVP) (not latch) has occurred 011: Boost over-temperature protection (latch-off) has occurred |
| 2 | BOOST_FAULT[0] | - | R | Yes | 100: The boost has stopped due to BATT_LOW (latch-off) |
| 1 | CHG_FAULT[1] | - | R | Yes | 00: Normal 01: Input OVP |
| 0 | CHG_FAULT[0] | - | R | Yes | 10: The charge timer has expired 11: Battery OVP |

REG14h

| Bits | Name | POR | R/W | INT | Description |
|------|---------------|-----|-----|-----|---|
| 7 | NTC_MISSING | - | R | Yes | 0: Normal 1: NTC is missing ($V_{NTC} > 95\%$ of V_{VRNTC}) |
| 6 | BATT_MISSING | - | R | Yes | 0: Normal 1: The battery is missing (2 terminations detected within 3 seconds) |
| 5 | NTC1_FAULT[2] | - | R | Yes | 000: Normal 001: Warm |
| 4 | NTC1_FAULT[1] | - | R | Yes | 010: Cool 011: Cold |
| 3 | NTC1_FAULT[0] | - | R | Yes | 100: Hot |
| 2 | NTC2_FAULT[2] | - | R | Yes | 000: Normal 001: Warm |
| 1 | NTC2_FAULT[1] | - | R | Yes | 010: Cool 011: Cold |
| 0 | NTC2_FAULT[0] | - | R | Yes | 100: Hot |

REG15h

| Bit | Name | POR | R/W | INT | Description |
|-----|-----------------|-----|-----|-----|---|
| 7 | CC1_SNK_STAT[1] | 0 | R | YM | 00: CC1 detects vRa 01: CC1 detects vRd-USB 10: CC1 detects vRd-1.5 11: CC1 detects vRd-3.0 A glitch in tPD_DEBOUNCE does not affect this result. |
| 6 | CC1_SNK_STAT[0] | 0 | R | YM | |
| 5 | CC2_SNK_STAT[1] | 0 | R | YM | 00: CC2 detects vRa 01: CC2 detects vRd-USB 10: CC2 detects vRd-1.5 11: CC2 detects vRd-3.0 A glitch in tPD_DEBOUNCE does not affect this result. |
| 4 | CC2_SNK_STAT[0] | 0 | R | YM | |
| 3 | CC1_SRC_STAT[1] | 0 | R | YM | 00: CC1 is vOPEN 01: CC1 detects vRd 10: CC1 detects vRa A glitch in tPD_DEBOUNCE does not affect this result. |
| 2 | CC1_SRC_STAT[0] | 0 | R | YM | |
| 1 | CC2_SRC_STAT[1] | 0 | R | YM | 00: CC2 is vOPEN 01: CC2 detects vRd 10: CC2 detects vRa A glitch in tPD_DEBOUNCE does not affect this result. |
| 0 | CC2_SRC_STAT[0] | 0 | R | YM | |

REG16h

| Bits | Name | POR | R/W | INT | Description |
|------|---------------|-----|-----|-----|--|
| 7 | RESERVED | - | R | No | Reserved. |
| 6 | TOPOFF_ACTIVE | - | R | YM | 0: The top-off timer is not counting 1: The top-off timer is counting |
| 5 | BFET_STAT | - | R | No | 0: The battery is charging or disabled 1: The battery is discharging |
| 4 | BATT_LOW_STAT | - | R | YM | The hysteresis = 200mV. 0: V _{BATT} is greater than BATT_LOW[1:0] 1: V _{BATT} is below BATT_LOW[1:0] |
| 3 | OTG_NEED | - | R | Yes | If the boost needs to be turned on/off by CC detection, this bit is set/reset with an INT pulse followed. 0: Boost should be disabled 1: Boost should be enabled |
| 2 | VIN_TEST_HIGH | - | R | Yes | 0: V _{IN} is below the VIN_TEST threshold 1: V _{IN} has reached the VIN_TEST threshold |
| 1 | DEBUGACC | - | R | YM | 0: Normal 1: Enters DebugAccessory.SNK state |
| 0 | AUDIOACC | - | R | YM | 0: Normal 1: Enters AudioAccessory state |

INTERRUPT LIST

| INT Name | Related registers | Can be Masked | Event |
|----------------|--|---------------|---|
| VIN_GD | VIN_GD changes | No | A good input source has been detected. |
| DPDM_DET_DONE | DPDM_STAT[3:0] changes | No | DPDM detection is finished. |
| VIN_RDY | VIN_RDY 0→1 | No | The input current limit has been updated; the buck converter starts. |
| CHG_DONE | CHG_STAT[2:0] any to 101 | No | Charging has terminated. |
| RECHARGE | CHG_STAT[2:0] exits 101 and enter CC/CV charge | No | Recharging has been initiated. |
| THERM_STAT | THERM_STAT 0→1 | Yes | The IC has entered charge thermal regulation. |
| WATCHDOG_FAULT | WATCHDOG_FAULT 0→1 | No | A watchdog timeout has occurred. |
| WATCHDOG_BARK | WATCHDOG_BARK 0→1 | No | A watchdog bark has occurred. |
| CHG_FAULT | CHG_FAULT[1:0] 00→01, 00→10, 00→11 | No | One of the following charge faults has occurred: input OVP, battery OVP, or the charge timer has expired. |
| NTC_MISSING | NTC_MISSING changes | No | NTC is missing. |
| BATT_MISSING | BATT_MISSING changes | No | BATT is missing. |
| BOOST_FAULT | BOOST_FAULT[2:0] 000→001, 000→010, 010→000, 000→011, 000→100 | No | One of the following boost fault has occurred: IN overload or short, boost OVP, boost OTP, the boost has stopped due to BATT_LOW. |
| NTC_FAULT | NTC1_FAULT[2:0] or NTC2_FAULT[2:0] changes | No | The NTC status has changed. |
| VINDPM_STAT | VINDPM_STAT 0→1 | Yes | The V _{IN} regulation loop has been entered. |
| IINDPM_STAT | IINDPM_STAT 0→1 | | The I _{IN} regulation loop has been entered. |
| TOPOFF_TMR | TOPOFF_ACTIVE changes | Yes | The TOPOFF timer has started and ended. |
| CC_SNK | CC1_SNK_STAT[1:0] or CC2_SNK_STAT[1:0] changes | Yes | vRd connect has been detected or the source current advertisement has changed. |
| CC_SRC | CC1_SRC_STAT[1:0] or CC2_SRC_STAT[1:0] changes | | vRd or vRa has been detected. |
| BATT_LOW | BATT_LOW_STAT 0→1 | Yes | V _{BATT} has dropped to the BATT_LOW threshold. |
| OTG_NEED | OTG_NEED changes | No | The host has to turn enable/disable boost. |
| VIN_TEST_HIGH | VIN_TEST_HIGH 0→1 | No | V _{IN} has reached the VIN_TEST threshold during the input impedance test. |
| DEBUGACC | DEBUGACC changes | Yes | DebugAccessory.SNK state entry/exit |
| AUDIOACC | AUDIOACC changes | | AudioAccessory state entry/exit |
| HVCHARGER | DPDM_STAT[3:0] Any → 1001 | No | A high-voltage charger has been detected. |

OTP MAP

The MP2722 has a one-time-programming (OTP) function to configure the default values for certain registers. The OTP map below shows the OTP-configurable commands.

| # | Bit[7] | Bit[6] | Bit[5] | Bit[4] | Bit[3] | Bit[2] | Bit[1] | Bit[0] |
|-----|--------------|-----------------|---------------|------------|-----------------|-----------------|------------------|------------------|
| 00h | N/A | EN_STAT_IB | EN_PG_NTC2 | N/A | HOLDOFF_ TMR | SW_FREQ[1:0] | | N/A |
| 01h | IIN_MODE | | | N/A | N/A | N/A | N/A | N/A |
| 02h | N/A | N/A | ICC[5:0] | | | | | |
| 03h | IPRE[3:0] | | | ITERM[3:0] | | | | |
| 04h | N/A | ITRICKLE[2:0] | | N/A | | | | |
| 05h | N/A | N/A | VBATT[5:0] | | | | | |
| 06h | VIN_OVP[1:0] | | SYS_MIN[2:0] | | N/A | N/A | N/A | N/A |
| 07h | N/A | N/A | WATCHDOG[1:0] | | N/A | N/A | N/A | N/A |
| 08h | N/A | N/A | N/A | N/A | N/A | VBOOST[2:0] | | |
| 09h | N/A | CC_CFG[2:0] | | AUTOOTG | | N/A | N/A | N/A |
| 0Ah | N/A | N/A | AUTODPDM | N/A | RP_CFG[1:0] | | FORCE_CC[1:0] | |
| 0Bh | N/A | N/A | N/A | HVEN | N/A | N/A | N/A | N/A |
| 0Ch | N/A | NTC1_ACTI ON | NTC2_ACTION | N/A | N/A | N/A | BOOST_ STP_EN | BOOST_O TP_EN |
| 10h | N/A | N/A | MASK_THERM | N/A | N/A | MASK_CC_ INT | N/A | N/A |

ONE-TIME PROGRAMMABLE (OTP) DEFAULT

| OTP Items | Default |
|---------------|--|
| EN_STAT_IB | 0: STAT |
| EN_PG_NTC2 | 0: PG |
| HOLDOFF_TMR | 1: Enable the hold-off timer |
| SW_FREQ[1:0] | 01: 1MHz |
| IIN_MODE[2:0] | 000: Follow IIN_LIM setting |
| ICC[5:0] | 011001: 2A |
| IPRE[3:0] | 0100: 240mA |
| ITERM[3:0] | 0011: 120mA |
| ITRICKLE[2:0] | 011: 128mA |
| VBATT[5:0] | 011000: 4.2V |
| VIN_OVP[1:0] | 00: 6.3V |
| SYS_MIN[2:0] | 100: 3.588V |
| WATCHDOG[1:0] | 01: 40s |
| VBOOST[2:0] | 111: 5.15V |
| CC_CFG[2:0] | 000: Sink only |
| AUTOOTG | 1: OTG is controlled automatically |
| AUTODPDM | 1: D+/D- detection automatically starts after VIN_GD = 1 and the hold-off timer ends |
| RP_CFG[1:0] | 01: 180uA (USB Type-C 1.5A) |
| FORCE_CC[1:0] | 00: CC1 and CC2 are configured automatically |
| HVEN | 1: Enable HV adaptor detection |
| NTC1_ACTION | 1: Active |
| NTC2_ACTION | 0: INT only |
| BOOST_STP_EN | 0: The BATT_LOW comparator only generates INT |
| BOOST_OTP_EN | 1: Boost operation stops if over-temperature protection occurs |
| MASK_THERM | 0: Allow INT |
| MASK_CC_INT | 0: Allow INT |

APPLICATION INFORMATION

Selecting the Inductor

Inductor selection is a tradeoff between cost, size, and efficiency. A lower-value inductor corresponds to a smaller size, but also results in a higher current ripple, higher magnetic hysteretic losses, and higher output capacitances. A higher-value inductor results in a lower ripple current and smaller output filter capacitors, but it also results in higher inductor DC resistance (DCR) loss.

The required inductance can be estimated with Equation (1):

$$L = \frac{V_{IN} - V_{SYS}}{\Delta I_{L_MAX}} \times \frac{V_{SYS}}{V_{IN} \times f_{SW}} \quad (1)$$

Where V_{IN} is the input voltage, V_{SYS} is the converter output voltage, f_{SW} is the switching frequency, and ΔI_{L_MAX} is the maximum peak-to-peak inductor current, which is typically designed to be 20% to 40% of the maximum load current.

Choose an inductor that does not saturate under the worst-case load condition, which can be calculated with Equation (2):

$$I_{SAT} > I_{LOAD} + \frac{\Delta I_{L_MAX}}{2} \quad (2)$$

Where I_{SAT} is the inductor saturation current, I_{LOAD} is the buck converter's maximum load.

Selecting the PMID Capacitor (C_{PMID})

The PMID capacitor (C_{PMID}) decouples the switching buck converter and absorbs the switching ripple current. Select C_{PMID} based on the demand for the PMID current ripple. The input current ripple can be calculated with Equation (3):

$$I_{RMS_MAX} = I_{LOAD} \times \frac{\sqrt{V_{SYS} \times (V_{IN} - V_{SYS})}}{V_{IN}} \quad (3)$$

Use low-ESR ceramic capacitors with an X7R or X5R rating for C_{PMID} . This capacitor should be placed as close to the PMID and PGND pins as possible. The capacitor's voltage rating must exceed V_{IN} , and it is recommended to consider the plug-in overshoot voltage. A capacitor rated for at least 25V is recommended for applications with a 15V V_{IN} . Generally, a capacitance of 10 μ F is considered a sufficient starting value.

PCB Layout Guidelines

PCB layout is important to meet specified noise, efficiency, and stability requirements. For the best results, refer to Figure 15 and follow the guidelines below:

1. Place the PMID capacitor as close to the PMID and PGND pins as possible using a short copper plane connection. Place the PMID capacitor on the same layer as the IC.
2. Minimize the high-frequency current path loop between the PMID capacitor and the buck converter power MOSFETs (from the PMID pin to the capacitor to ground).
3. Place the inductor's input terminal as close to the SW pin as possible.
4. Minimize the copper area of the inductor's input terminal trace to reduce electrical and magnetic field radiation, but ensure that the trace is wide enough to carry the charging current.
5. Minimize parasitic capacitance from the inductor input terminal to any other trace or plane.

6. Place decoupling capacitors (e.g. the VCC pin capacitor) as close to the IC pins as possible, and make the connection as short as possible.
7. Connect the IC's power pin to as many copper planes as possible to conduct heat away from the IC.
8. Ensure that the number and physical size of the vias are sufficient for a current path.

Figure 15 shows a high-frequency current path. In this figure, the high-frequency path (the high-side MOSFET, low-side MOSFET and the PMID capacitor) must be minimized.

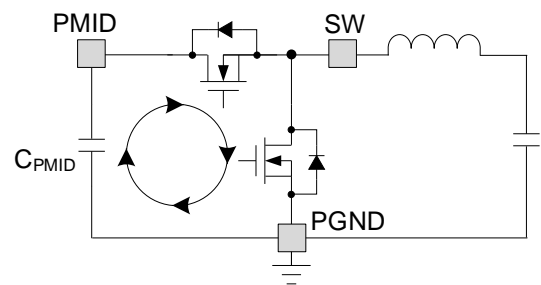

Figure 15: High-Frequency Current Path

TYPICAL APPLICATION CIRCUIT

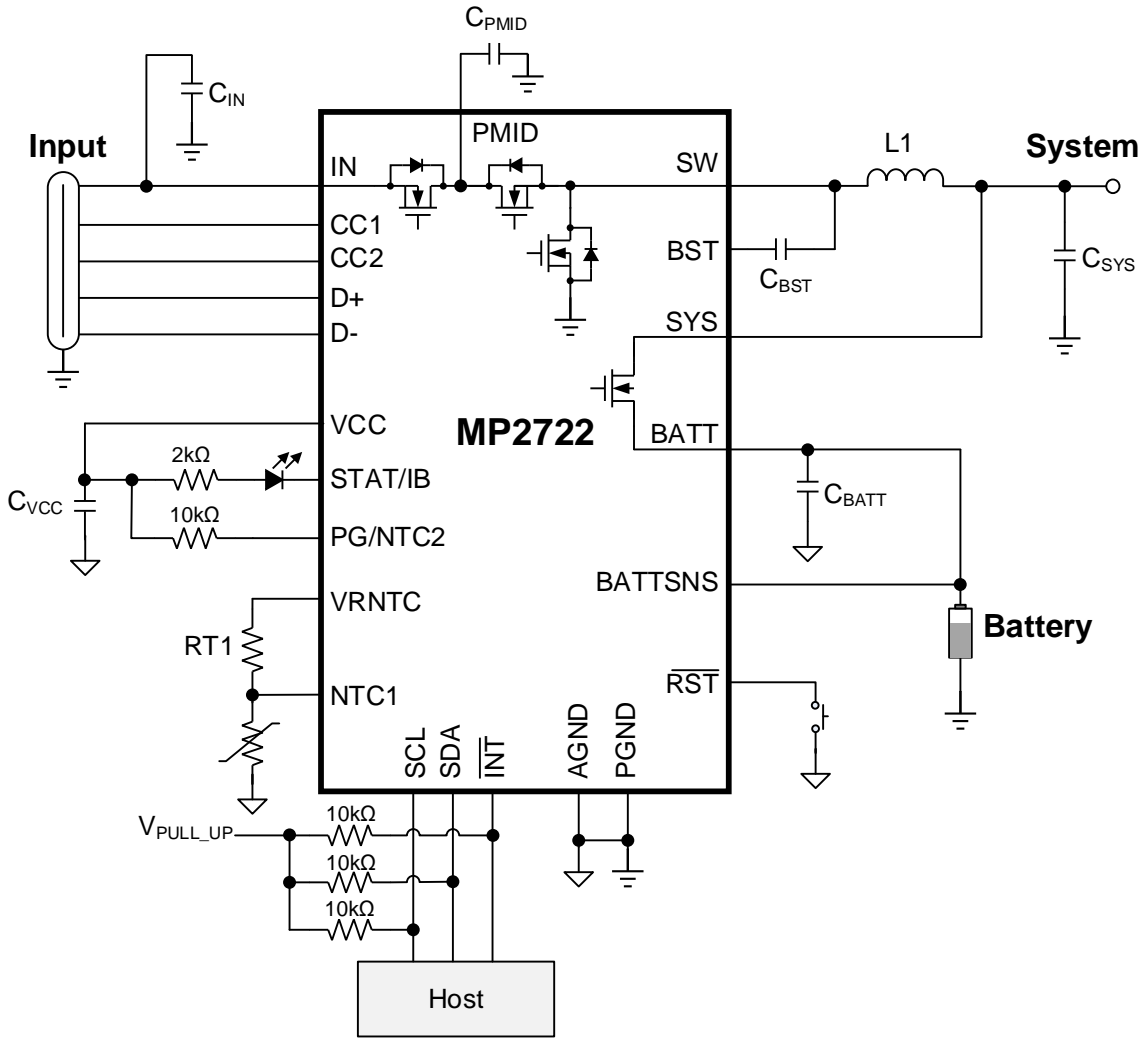

Figure 16: Typical Application Circuit

Table 8: Key BOM of Figure 16

| Qty | Ref | Value | Description | Package | Manufacturer |
|-----|-------------------|----------|---|---------|--------------|
| 1 | C _{IN} | 1μF | Ceramic capacitor, 25V, X5R or X7R | 0603 | Any |
| 1 | C _{PMID} | 10μF | Ceramic capacitor, 25V, X5R or X7R | 0805 | Any |
| 2 | C _{SYS} | 10μF x 2 | Ceramic capacitor, 16V, X5R or X7R | 0805 | Any |
| 1 | C _{BATT} | 10μF | Ceramic capacitor, 16V, X5R or X7R | 0805 | Any |
| 1 | C _{VCC} | 4.7μF | Ceramic capacitor, 10V, X5R or X7R | 0603 | Any |
| 1 | C _{BST} | 22nF | Ceramic capacitor, 16V, X5R or X7R | 0603 | Any |
| 1 | L1 | 1μH | Inductor, 1μH, low DCR | SMD | Any |
| 1 | RT1 | 10kΩ | Film resistor, 1%, same value as the NTC resistance at 25°C | 0603 | Any |

PACKAGE INFORMATION

QFN-22 (2.5mmx3.5mm)

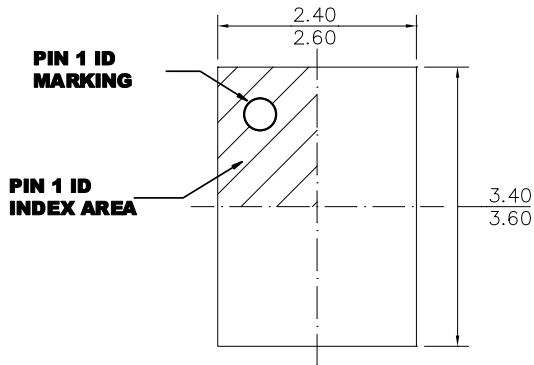

TOP VIEW

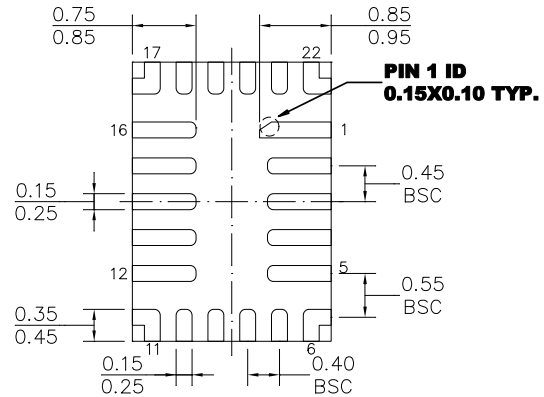

BOTTOM VIEW



SIDE VIEW

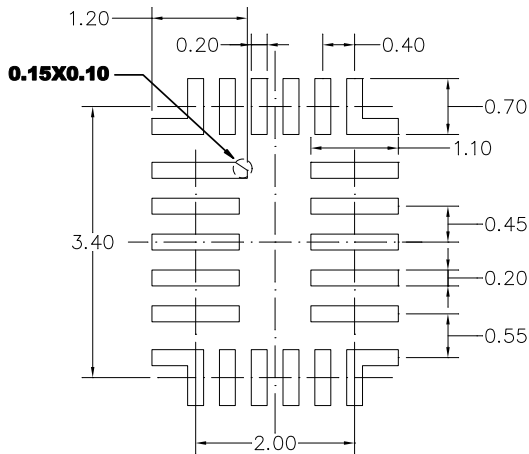

RECOMMENDED LAND PATTERN

NOTE:

- 1) ALL DIMENSIONS ARE IN MILLIMETERS.
- 2) LEAD COPLANARITY SHALL BE 0.08 MILLIMETERS MAX.
- 3) JEDEC REFERENCE IS MO-220.
- 4) DRAWING IS NOT TO SCALE.

CARRIER INFORMATION

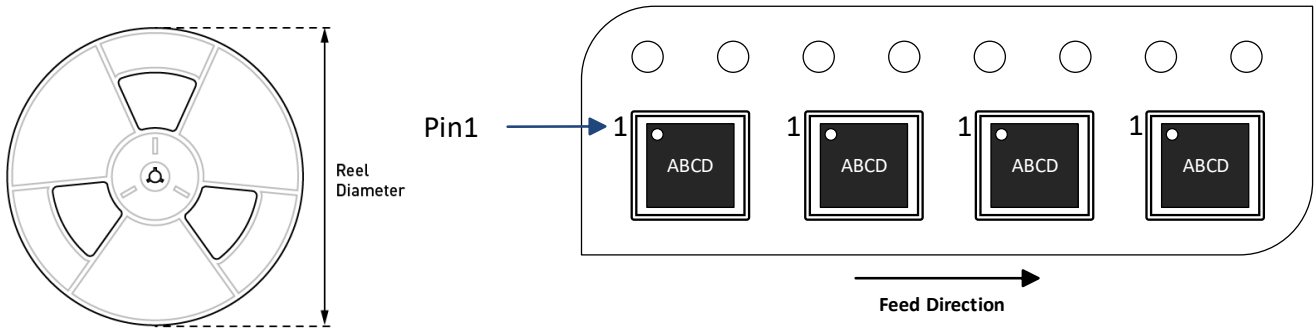

| Part Number | Package Description | Quantity/ Reel | Quantity/ Tube | Quantity/ Tray | Reel Diameter | Carrier Tape Width | Carrier Tape Pitch |
|---------------------|-------------------------|----------------|----------------|----------------|---------------|--------------------|--------------------|
| MP2722GRH- xxx-Z | QFN-22 (2.5mmx3.5mm) | 5000 | N/A | N/A | 13in | 12mm | 8mm |



REVISION HISTORY

| Revision # | Revision Date | Description | Pages Updated |
|------------|---------------|-----------------|---------------|
| 1.0 | 11/3/2022 | Initial Release | - |

Notice: The information in this document is subject to change without notice. Please contact MPS for current specifications. Users should warrant and guarantee that third-party Intellectual Property rights are not infringed upon when integrating MPS products into any application. MPS will not assume any legal responsibility for any said applications.