

## S5AC-HF Thru. S5MC-HF

Reverse Voltage: 50 to 1000 Volts

Forward Current: 5.0 Amp

RoHS Device

Halogen Free

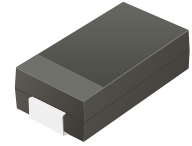

### Features

- For surface mounted applications.
- Low profile package.
- Glass passivated chip junction.
- Easy to pick and place.

### Mechanical data

- Case: SMC
- Terminals: Solderable per MIL-STD-750, method 2026.

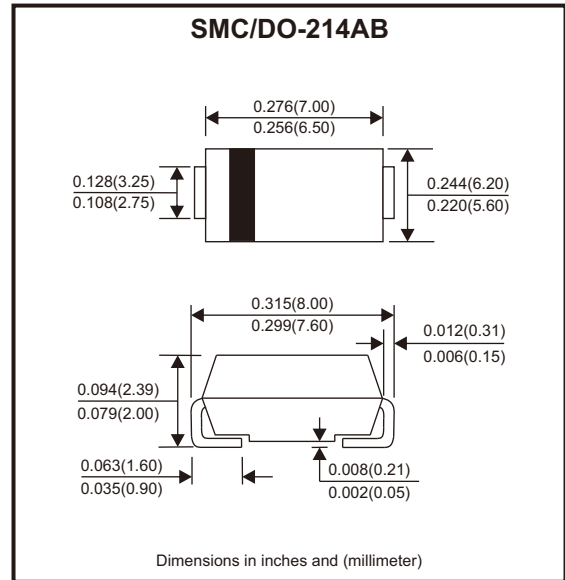

### Circuit Diagram



### Maximum Ratings and Electrical Characteristics

Ratings at 25°C ambient temperature unless otherwise specified.  
Single phase, half wave, 60Hz resistive or inductive load, for capacitive load, derate by 20%

Parameter	Symbols	S5AC-HF	S5BC-HF	S5DC-HF	S5GC-HF	S5JC-HF	S5KC-HF	S5MC-HF	Units
Maximum repetitive peak reverse voltage	$V_{RRM}$	50	100	200	400	600	800	1000	V
Maximum RMS voltage	$V_{RMS}$	35	70	140	280	420	560	700	V
Maximum DC blocking voltage	$V_{DC}$	50	100	200	400	600	800	1000	V
Maximum average forward rectified current	$I_{F(AV)}$	5							A
Peak forward surge current, 8.3ms single half sine-wave superimposed on rated load	$I_{FSM}$	120							A
Max instantaneous forward voltage at 5A	$V_F$	1.0							V
Maximum DC reverse current at rated DC blocking voltage	$I_R$	5 100							$\mu A$
Typical junction capacitance (Note 1)	$C_j$	50							pF
Typical thermal resistance (Note 2)	$R_{\theta JA}$ $R_{\theta JC}$	35 13							$^{\circ}C/W$
Operating and storage temperature range	$T_j, T_{stg}$	-55 ~ +150							$^{\circ}C$

Notes: 1. Measured at 1 MHz and applied reverse voltage of 4 V D.C  
2. P.C.B. mounted with 2.0" X 2.0" (5 X 5 cm) copper pad areas.

## Rating and Characteristic Curves (S5AC-HF Thru. S5MC-HF)

Fig.1 - Forward Current Derating Curve

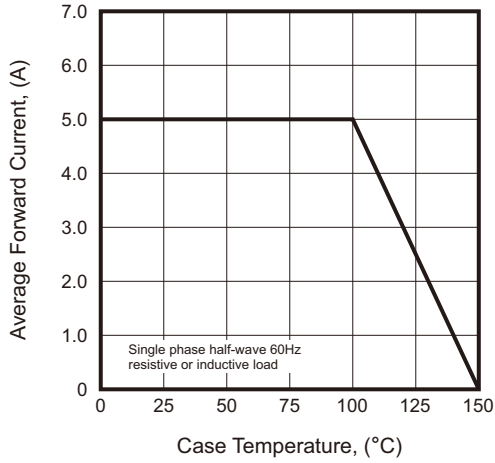

Fig.2 - Typical Reverse Characteristics

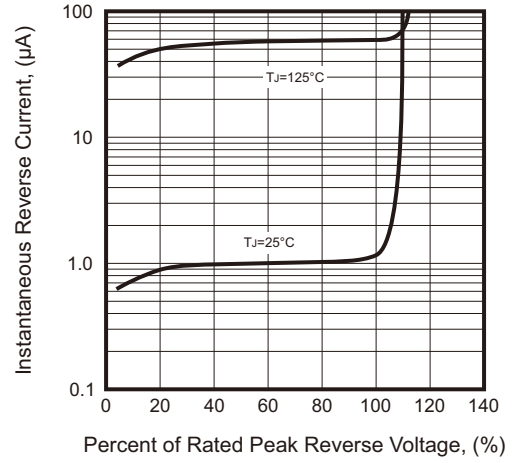

Fig.3 - Typical Forward Characteristic

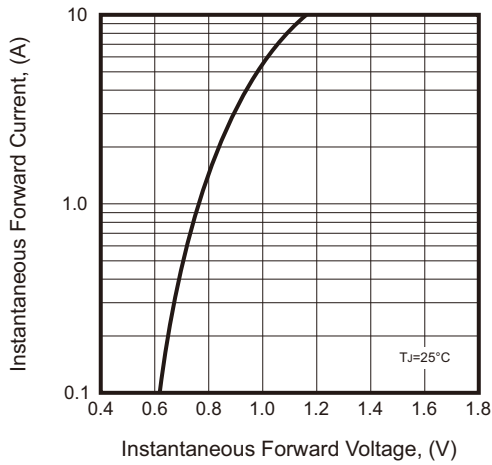

Fig.4 - Typical Junction Capacitance

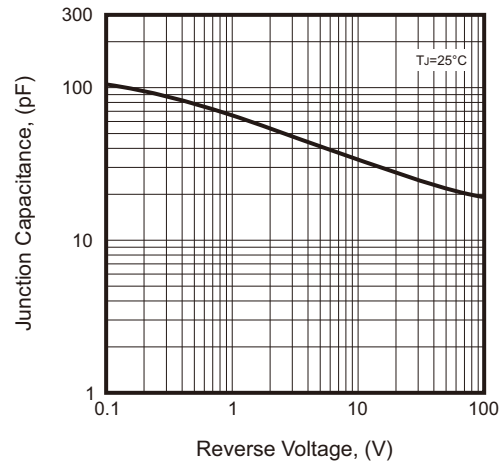
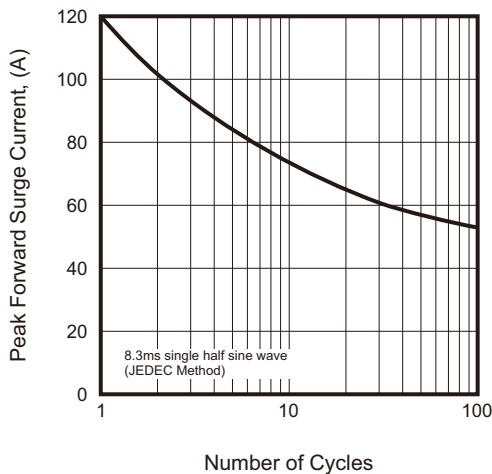
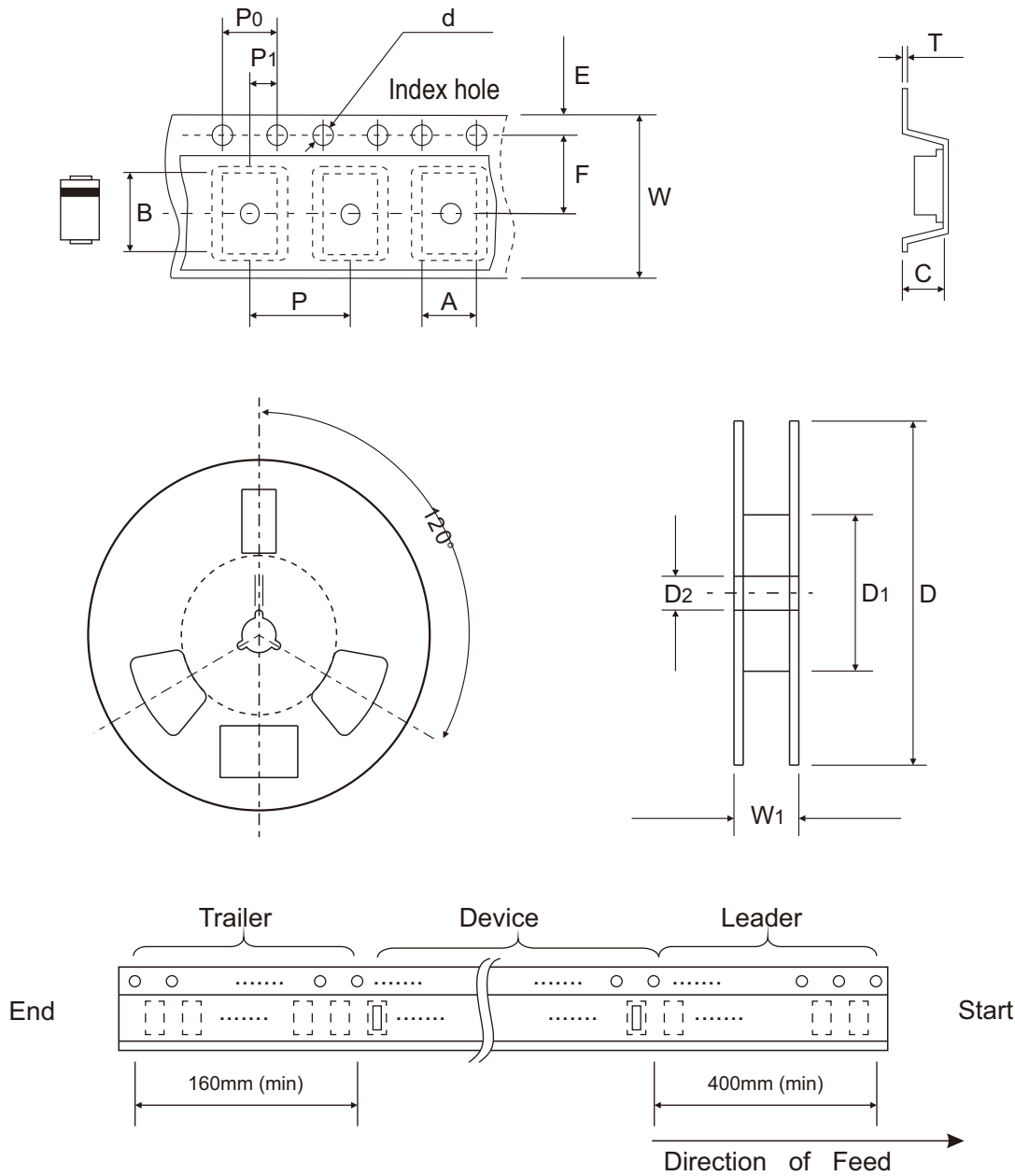

Fig.5 - Maximum Non-Repetitive Peak Forward Surge Current



Company reserves the right to improve product design, functions and reliability without notice.

## Reel Taping Specification



DO-214AB (SMC)	SYMBOL	A	B	C	d	D	D1	D2
	(mm)	6.22 ± 0.10	8.31 ± 0.10	2.49 ± 0.10	1.55 ± 0.05	330 ± 2.00	100.00 ± 1.00	13.00 ± 0.20
	(inch)	0.245 ± 0.004	0.327 ± 0.004	0.098 ± 0.004	0.061 ± 0.002	12.992 ± 0.079	3.937 ± 0.039	0.512 ± 0.008

DO-214AB (SMC)	SYMBOL	E	F	P	P0	P1	T	W	W1
	(mm)	1.75 ± 0.10	7.50 ± 0.10	8.00 ± 0.10	4.00 ± 0.10	2.00 ± 0.05	0.28 ± 0.02	16.00 ± 0.30	21.00 + 2.00 - 1.00
	(inch)	0.069 ± 0.004	0.295 ± 0.004	0.315 ± 0.004	0.157 ± 0.004	0.079 ± 0.002	0.011 ± 0.001	0.630 ± 0.012	0.827 + 0.079 - 0.039

Company reserves the right to improve product design , functions and reliability without notice.

REV:A

## Marking Code

Part Number	Marking Code
S5AC-HF	S5A
S5BC-HF	S5B
S5DC-HF	S5D
S5GC-HF	S5G
S5JC-HF	S5J
S5KC-HF	S5K
S5MC-HF	S5M

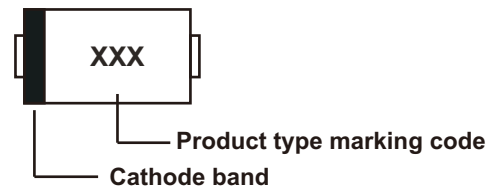

xxx = Product type marking code

## Suggested PAD Layout

SIZE	DO-214AB (SMC)	
	(mm)	(inch)
A	3.80	0.150
B	4.10	0.161
C	4.30	0.169
D	12.00	0.472

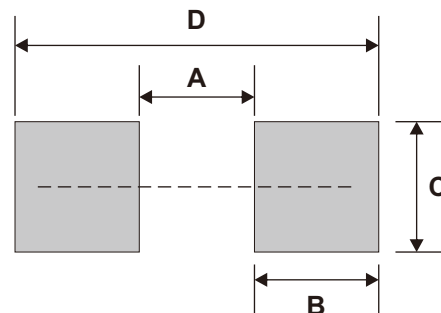

Note: 1. The pad layout is for reference purpose only.

## Standard Packaging

Case Type	REEL PACK	
	REEL ( pcs )	Reel Size (inch)
DO-214AB (SMC)	3,000	13