

Customer Part:



Description

- Surface mount 3.2 x 2.5mm crystal oscillator in a hermetically sealed ceramic package with a seam sealed metal lid.
- Model CFPS-39
- Model Issue number 7
- Note: please be aware that devices supplied against this model may show slight cosmetic differences depending upon the frequency and specification, however all electrical details remain as per the model specification.

Frequency Parameters

- Frequency 22.57920MHz
- Frequency Stability ±25.00ppm
- Operating Temperature Range -40.00 to 85.00°C
- Ageing ±5ppm max per year @ 25°C

Electrical Parameters

- Supply Voltage 3.3V ±10%
- Current Draw 20.000mA

Output Details

- Output Compatibility CMOS
- Drive Capability 15pF max
- Rise and Fall Time 7.0ns max
- Duty Cycle 40/60
- Output Low Vol: 10% Vs max
- Output High Voh: 90% Vs min
- Start-Up Time: 10ms max

Output Control

- Standby Operation:
 Logic '1' (>70% Vs) to pad 1 enables oscillator output
 Logic '0' (<30% Vs) to pad 1 disables oscillator output; when disabled the oscillator output goes to the high impedance state
 No connection to pad 1 enables oscillator output
 Standby Current: 10µA max

Noise Parameters

- RMS Phase Jitter:
 (Bandwidth 12kHz to 5MHz): 1ps max, frequency range 10MHz~39.9MHz
 (Bandwidth 12kHz to 20MHz): 1ps max, frequency range 40MHz~125MHz

Environmental Parameters

- Storage Temperature Range: -55 to 125°C
- Shock: Half Sine shock pulse with peak acceleration 500g; Pulse duration: 0.3ms
- Vibration: MIL-STD-202 Method 204. 5g for 20 minutes, 12 cycles in each of the 3 orientations, 10 - 2000 Hz. As per Table 11 of AEC-Q200.

Manufacturing Details

- RoHS Terminations NiAu
- RoHS Reflow Temp 260°C max for 10s max



Outline (mm)

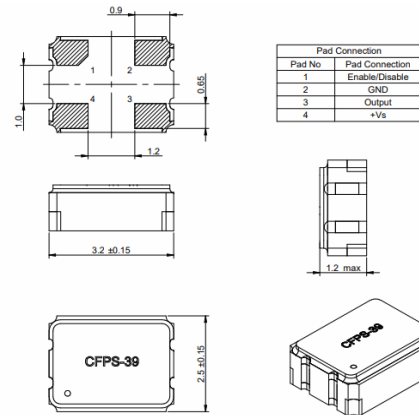

Recommended Solder Pad Layout

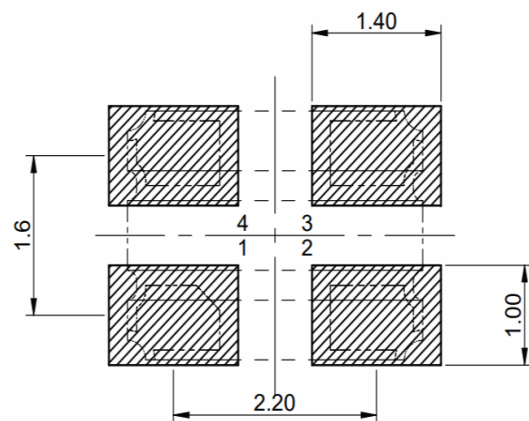

Sales Office Contact Details:

UK: +44 (0)1460 270200

Email: info@iqdfrequencyproducts.com

Web: www.iqdfrequencyproducts.com

Customer Part:

Compliance

- RoHS Status (2015/863/EU) Compliant
- REACH Status Compliant
- MSL Rating (JDEC-STD-033): Not Applicable

Packaging Details

- Tape & reel in accordance with EIA-481
Quantities below the standard reel size to be supplied on cut tape

Standard Pack Quantity: 3,000

Test Circuit

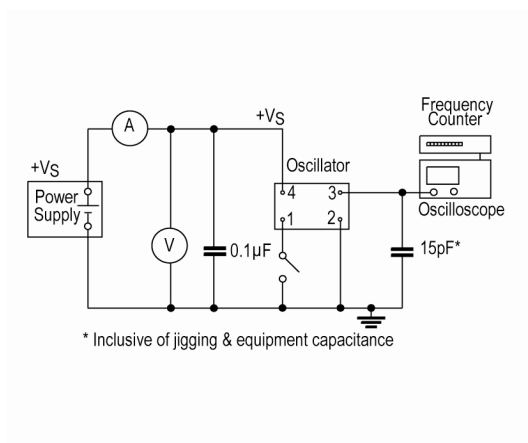

Waveform

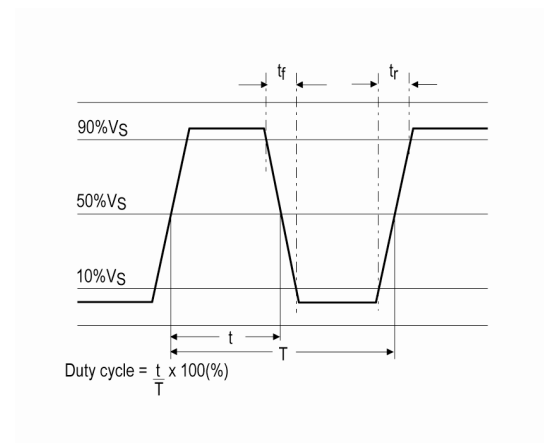

Sales Office Contact Details:

UK: +44 (0)1460 270200

Email: info@iqdfrequencyproducts.com

Web: www.iqdfrequencyproducts.com