

## SOLID-STATE RELAYS

### Features

- > Rugged, epoxy encapsulation construction
- > 4,000 volts of optical isolation
- > Subjected to full load test and six times the rated current surge before and after encapsulation
- > Unique heat-spreader technology
- > Guaranteed for life

### OVERVIEW

In 1974, Opto 22 introduced the first liquid epoxy-filled line of power solid-state relays (SSR). This innovation in SSR design greatly improved the reliability and reduced the cost of manufacturing. At that time, we also incorporated into our manufacturing process 100% testing under full-load conditions of every relay we produced.

By 1978, Opto 22 had gained such a reputation for reliability that we were recognized as the world's leading manufacturer of solid-state relays. Through continuous manufacturing improvements and the same 100% testing policy established over 40 years ago, Opto 22 is



Opto 22 Power Series SSR

still recognized today for the very high quality and reliability of all our solid-state relays.

### DESCRIPTION

Opto 22 offers a complete line of SSRs, from the rugged 120/240/380-volt **AC Series** to the small footprint **MP Series**, designed for mounting on printed circuit boards. All Opto 22 SSRs feature 4,000 volts of optical isolation, and most are UL and CSA recognized. The innovative use of room-temperature liquid epoxy encapsulation, coupled with Opto 22's unique heat-spreader technology, are key to mass producing the world's most reliable solid-state relays.

### Part Numbers

| Part                    | Description                                                                       |
|-------------------------|-----------------------------------------------------------------------------------|
| <b>AC Switching</b>     |                                                                                   |
| 120A10                  | 120 VAC, 10 Amp, AC Control                                                       |
| 120A25                  | 120 VAC, 25 Amp, AC Control                                                       |
| 240A10                  | 240 VAC, 10 Amp, AC Control                                                       |
| 240A25                  | 240 VAC, 25 Amp, AC Control                                                       |
| 240A45                  | 240 VAC, 45 Amp, AC Control                                                       |
| 120D3                   | 120 VAC, 3 Amp, DC Control                                                        |
| 120D10                  | 120 VAC, 10 Amp, DC Control                                                       |
| 120D25                  | 120 VAC, 25 Amp, DC Control                                                       |
| 120D45                  | 120 VAC, 45 Amp, DC Control                                                       |
| 240D3                   | 240 VAC, 3 Amp, DC Control                                                        |
| 240D10                  | 240 VAC, 10 Amp, DC Control                                                       |
| 240Di10                 | 240 VAC, 10 Amp, DC Control, with LED Indicators                                  |
| 240D25                  | 240 VAC, 25 Amp, DC Control                                                       |
| 240Di25                 | 240 VAC, 25 Amp, DC Control, with LED Indicators                                  |
| 240D30-HS<br>[Obsolete] | [Obsolete] 240 VAC, 30 Amp, DC Control, with integrated heatsink                  |
| 240D45                  | 240 VAC, 45 Amp, DC Control                                                       |
| 240Di45                 | 240 VAC, 45 Amp, DC Control, with LED Indicators                                  |
| 380D25                  | 380 VAC, 25 Amp, DC Control                                                       |
| 380D45                  | 380 VAC, 45 Amp, DC Control                                                       |
| 480D10-12               | 480 VAC, 10 Amp, DC Control, Transient Proof                                      |
| 480D15-12               | 480 VAC, 15 Amp, DC Control, Transient Proof                                      |
| 480D25-12               | 480 VAC, 25 Amp, DC Control, Transient Proof                                      |
| 480D25-HS<br>[Obsolete] | [Obsolete] 480 VAC, 25 Amp, DC Control, Transient Proof, with integrated heatsink |
| 480D45-12               | 480 VAC, 45 Amp, DC Control, Transient Proof                                      |

| Part                    | Description                                                                       |
|-------------------------|-----------------------------------------------------------------------------------|
| <b>AC Switching</b>     |                                                                                   |
| 575D15-12               | 575 VAC, 15 Amp, DC Control, Transient Proof                                      |
| 575D45-12               | 575 VAC, 45 Amp, DC Control, Transient Proof                                      |
| 575D30-HS<br>[Obsolete] | [Obsolete] 575 VAC, 30 Amp, DC Control, Transient Proof, with integrated heatsink |
| 575Di45-12              | 575 VAC, 45 Amp, DC Control, Transient Proof, with LED Indicators                 |
| MP120D2 or<br>P120D2    | 120 VAC, 2 Amp, DC Control<br>P model is low profile                              |
| MP120D4 or<br>P120D4    | 120 VAC, 4 Amp, DC Control<br>P model is low profile                              |
| MP240D2 or<br>P240D2    | 240 VAC, 2 Amp, DC<br>P model is low profile                                      |
| MP240D4 or<br>P240D4    | 240 VAC, 4 Amp, DC<br>P model is low profile                                      |
| MP380D4                 | 380 VAC, 4 Amp, DC                                                                |
| Z120D10                 | Z Model, 120 VAC, 10 Amp, DC Control                                              |
| Z240D10                 | Z Model, 240 VAC, 10 Amp, DC Control                                              |
| <b>DC Switching</b>     |                                                                                   |
| DC60P or<br>DC60MP      | 60 VDC, 3 Amp, DC Control<br>P model is low profile                               |
| DC200P or<br>DC200MP    | 200 VDC, 1 Amp, DC Control<br>P model is low profile                              |
| DC60S-3                 | 60 VDC, 3 Amp, DC Control                                                         |
| DC60S-5                 | 60 VDC, 5 Amp, DC Control                                                         |
| <b>Accessories</b>      |                                                                                   |
| SAFETY COVER            | Power Series SSR safety cover                                                     |
| SSR-HS                  | Power Series SSR heatsink                                                         |
| SSR-THERMOPAD           | Thermal conductive pad (pack of 10)                                               |

Every Opto 22 solid-state relay is subjected to full load test and six times the rated current surge both before and after encapsulation. This double testing of every part before it leaves the factory means you can rely on Opto 22 solid-state relays. All Opto 22 SSRs are guaranteed for life.

Accessories for the Power-Series SSRs include a safety cover, a heatsink, and a matching thermal conductive pad. See [page 3](#).

## Power Series SSRs



Opto 22 provides a full range of Power Series relays with a wide variety of voltage (120–575 volts) and current options (3–45 amps). All Power Series relays feature 4,000 volts of optical isolation and have a high PRV rating. Some Power Series relays include built-in LEDs to indicate operation. See [page 4](#).

## DC Series

The DC Series delivers isolated DC control to large OEM customers worldwide. All DC control SSRs are LS TTL compatible.

## AC Series

The AC Series offers the ultimate in solid state reliability. All AC Power Series relays feature a built-in snubber as well as zero-voltage turn-on and zero-current turn-off. Transient-proof models offer self protection for noisy electrical environments.

## Z Series SSRs

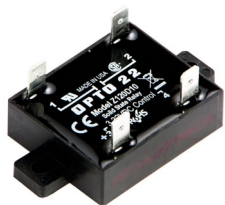

The Z Series employs a unique heat transfer system that makes it possible for Opto 22 to deliver a low-cost, 10-amp, solid-state relay in an all-plastic case. The push-on, tool-free quick-connect terminals make the Z Series ideal for high-volume OEM applications. Operating temperature:  $-40^{\circ}\text{C}$  to  $100^{\circ}\text{C}$ . See [page 7](#).

## Printed Circuit Series SSRs



Opto 22's Printed Circuit Series allows OEMs to easily deploy solid-state relays on printed circuit boards. Two unique packages are available, both of which will switch loads up to four amps. Operating temperature:  $-40^{\circ}\text{C}$  to  $100^{\circ}\text{C}$ . See [page 9](#).

## MP Series

The MP Series packaging is designed with a minimum footprint to allow maximum relay density on the printed circuit board.

## P Series

The P Series power relays provide low-profile [0.5 in. (12.7 mm)] center mounting on printed circuit boards.

## HS Series SSRs



The HS Series features an integrated heatsink, which makes them so *cool*. These relays have less thermal resistance inside, so heat dissipates more easily than in a standard SSR mounted to the same heatsink. With the heatsink built-in, you don't have to select one from a catalog, and installation is much easier. Includes a DIN-rail adapter. See [page 13](#).

## SPECIFICATIONS (ALL POWER SERIES MODELS)

- 4,000 V optical isolation, input to output
- Zero voltage turn-on
- Zero-current turn-off
- Turn-on time: 0.5 cycle maximum
- Turn-off time: 0.5 cycle maximum
- Operating temperature:  $-40^{\circ}\text{C}$  to  $100^{\circ}\text{C}$
- Operating frequency: 25 to 65 Hz (operates at 400 Hz with six times off-state leakage)
- Coupling capacitance, input to output: 8 pF maximum
- Hermetically sealed
- DV/DT Off-state: 200 volts per microsecond
- DV/DT commutating: snubbed for rated current at 0.5 power factor
- UL recognized
- CSA certified
- CE component
- UKCA certified
- Torque specs for screws (this spec is both the recommended torque and the maximum torque you should use):  
Control terminals, 10 in-lb (1.13 N-m)  
Field terminals, 18 in-lb (2.03 N-m)

## POWER SERIES SSR ACCESSORIES

### Safety Cover

A plastic safety cover (Opto 22 part number SAFETY COVER) is available for use with Opto 22 Power Series SSRs. The safety cover reduces the chance of accidental contact with relay terminals, while providing access holes for test instrumentation.

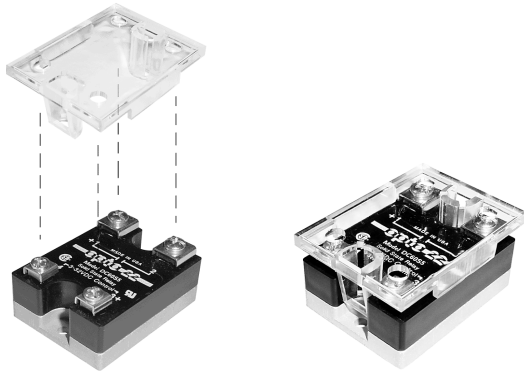

An optional plastic safety cover can be installed on a Power Series SSR.

### SSR-HS Heatsink

Custom designed for the Power Series SSRs, the SSR-HS heatsink provides excellent heat dissipation when mounted to the SSR with a matching thermal conductive pad, used in place of silicon grease. One thermal pad is included with the heatsink. Additional pads may be purchased in packs of 10 (part number SSR-THERMOPAD). DIN-rail adapter is included.

### Thermal Ratings

The thermal ratings shown in the following graphs were obtained with an SSR attached to a heatsink using a thermal conductive pad.

#### 45 Amp Relay on SSR-HS Heatsink Derating

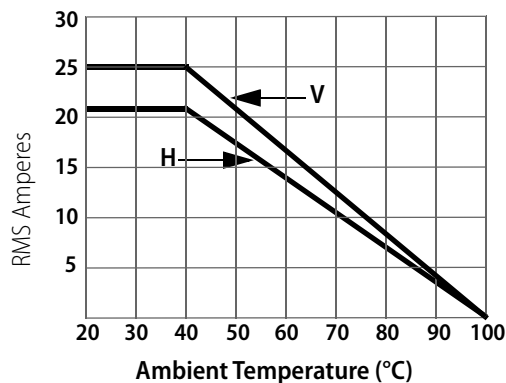

**V:** Heatsink mounted to a **vertical** surface  
**H:** Heatsink mounted to a **horizontal** surface.

#### 25 Amp Relay on SSR-HS Heatsink Derating

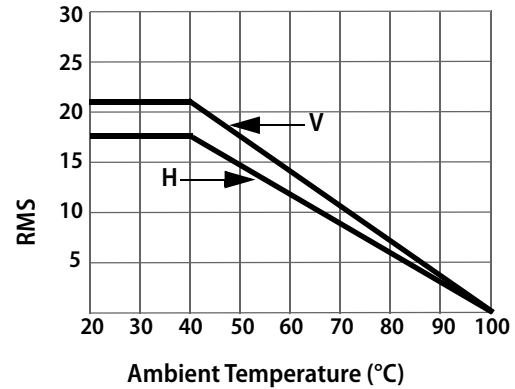

**V:** Heatsink mounted to a **vertical** surface  
**H:** Heatsink mounted to a **horizontal** surface.

### Heatsink Assembly

Before attaching the SSR, remove the protective film from both sides of the thermal pad, then place the pad on the heatsink making sure to align the holes. Secure the SSR to the heatsink with the two 8-32 x 3/8" panhead Phillips screws included in the kit. Use 20 in-lb (2.26 N-m) of torque.

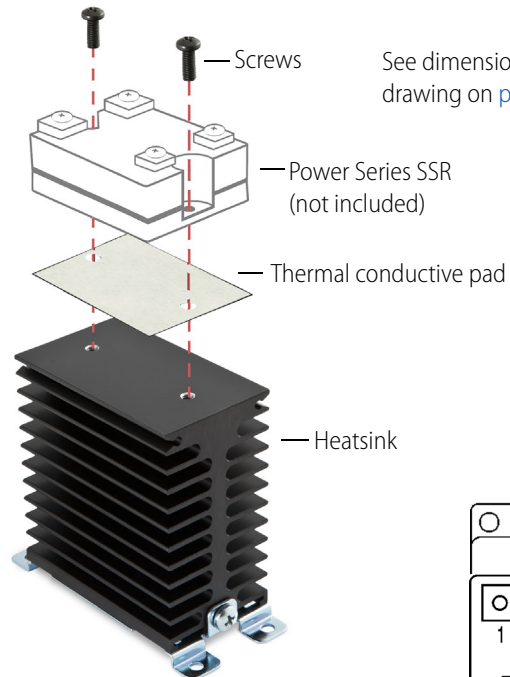

*NOTE: To take advantage of the cooling effect of natural air flow, mount the SSR/heatsink assembly to a vertical surface with the Opto 22 logo right side up as shown here.*

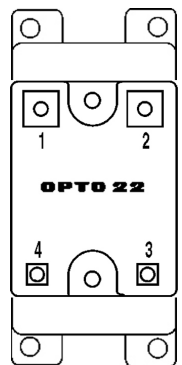

## AC POWER SERIES SPECIFICATIONS

Opto 22 provides a full range of Power Series relays with a wide variety of voltage (120–575) and current options (3–45 amps). All Power Series relays feature 4,000 volts of optical isolation and have a high PRV rating. Operating temperature is –40 °C to 100 °C. (Ambient temperature will affect the current rating.)

### 120/240/380 Volt

NOTE: Model numbers ending in -17 are replacement parts only. Their specifications are identical to the same model number without the -17. For example, 240D10-17 is identical to 240D10.

| Model Number | Nominal AC Line Voltage | Nominal Current Rating (Amps) | 1 cycle Surge (Amps) Peak | Nominal Signal Input Resistance (Ohms) | Signal Pick-up Voltage | Signal Drop-out Voltage | Peak Repetitive Voltage Maximum | Maximum Output Voltage Drop | Off-State Leakage (mA) Maximum** | Operating Voltage Range (Volts AC) | I <sup>2</sup> t Rating t=8.3 (ms) | Isolation Voltage     | θ <sub>jc</sub> *** (°C/Watt) | Dissipation (Watts/Amp) |
|--------------|-------------------------|-------------------------------|---------------------------|----------------------------------------|------------------------|-------------------------|---------------------------------|-----------------------------|----------------------------------|------------------------------------|------------------------------------|-----------------------|-------------------------------|-------------------------|
| 120D3        | 120                     | 3*                            | 85                        | 1000                                   | 3VDC (32V allowed)     | 1 VDC                   | 600                             | 1.6 volts                   | 2.5mA                            | 12–140                             | 30                                 | 4,000V <sub>RMS</sub> | 11                            | 1.7                     |
| 120D10       | 120                     | 10*                           | 110                       | 1000                                   | 3VDC (32V allowed)     | 1 VDC                   | 600                             | 1.6 volts                   | 7 mA                             | 12–140                             | 50                                 | 4,000V <sub>RMS</sub> | 1.3                           | 1.6                     |
| 120D25       | 120                     | 25*                           | 250                       | 1000                                   | 3VDC (32V allowed)     | 1 VDC                   | 600                             | 1.6 volts                   | 7 mA                             | 12–140                             | 250                                | 4,000V <sub>RMS</sub> | 1.2                           | 1.3                     |
| 120D45       | 120                     | 45*                           | 650                       | 1000                                   | 3VDC (32V allowed)     | 1 VDC                   | 600                             | 1.6 volts                   | 7 mA                             | 12–140                             | 1750                               | 4,000V <sub>RMS</sub> | 0.67                          | 0.9                     |
| 240D3        | 240                     | 3*                            | 85                        | 1000                                   | 3VDC (32V allowed)     | 1 VDC                   | 600                             | 1.6 volts                   | 5 mA                             | 24–280                             | 30                                 | 4,000V <sub>RMS</sub> | 11                            | 1.7                     |
| 240D10       | 240                     | 10*                           | 110                       | 1000                                   | 3VDC (32V allowed)     | 1 VDC                   | 600                             | 1.6 volts                   | 14 mA                            | 24–280                             | 50                                 | 4,000V <sub>RMS</sub> | 1.3                           | 1.6                     |
| 240Di10      | 240                     | 10*                           | 110                       | 730                                    | 3VDC (32V allowed)     | 1 VDC                   | 600                             | 1.6 volts                   | 14 mA                            | 24–280                             | 50                                 | 4,000V <sub>RMS</sub> | 1.3                           | 1.6                     |
| 240D25       | 240                     | 25*                           | 250                       | 1000                                   | 3VDC (32V allowed)     | 1 VDC                   | 600                             | 1.6 volts                   | 14 mA                            | 24–280                             | 250                                | 4,000V <sub>RMS</sub> | 1.2                           | 1.3                     |
| 240Di25      | 240                     | 25*                           | 250                       | 730                                    | 3VDC (32V allowed)     | 1 VDC                   | 600                             | 1.6 volts                   | 14 mA                            | 12–280                             | 250                                | 4,000V <sub>RMS</sub> | 1.2                           | 1.3                     |
| 240D45       | 240                     | 45*                           | 650                       | 1000                                   | 3VDC (32V allowed)     | 1 VDC                   | 600                             | 1.6 volts                   | 14 mA                            | 24–280                             | 1750                               | 4,000V <sub>RMS</sub> | 0.67                          | 0.9                     |
| 240Di45      | 240                     | 45*                           | 650                       | 730                                    | 3VDC (32V allowed)     | 1 VDC                   | 600                             | 1.6 volts                   | 14 mA                            | 24–280                             | 1750                               | 4,000V <sub>RMS</sub> | 0.67                          | 0.9                     |
| 380D25       | 380                     | 25*                           | 250                       | 1000                                   | 3VDC (32V allowed)     | 1 VDC                   | 800                             | 1.6 volts                   | 12 mA                            | 24–420                             | 250                                | 4,000V <sub>RMS</sub> | 1.2                           | 1.3                     |
| 380D45       | 380                     | 45*                           | 650                       | 1000                                   | 3VDC (32V allowed)     | 1 VDC                   | 800                             | 1.6 volts                   | 12 mA                            | 24–420                             | 1750                               | 4,000V <sub>RMS</sub> | 0.67                          | 0.9                     |
| 120A10       | 120                     | 10*                           | 110                       | 33K                                    | 85VAC (280V allowed)   | 10 VAC                  | 600                             | 1.6 volts                   | 7 mA                             | 12–140                             | 50                                 | 4,000V <sub>RMS</sub> | 1.3                           | 1.6                     |
| 120A25       | 120                     | 25*                           | 250                       | 33K                                    | 85VAC (280V allowed)   | 10 VAC                  | 600                             | 1.6 volts                   | 7 mA                             | 12–140                             | 250                                | 4,000V <sub>RMS</sub> | 1.2                           | 1.3                     |
| 240A10       | 240                     | 10*                           | 110                       | 33K                                    | 85VAC (280V allowed)   | 10 VAC                  | 600                             | 1.6 volts                   | 14 mA                            | 24–280                             | 50                                 | 4,000V <sub>RMS</sub> | 1.3                           | 1.6                     |
| 240A25       | 240                     | 25*                           | 250                       | 33K                                    | 85VAC (280V allowed)   | 10 VAC                  | 600                             | 1.6 volts                   | 14 mA                            | 24–280                             | 250                                | 4,000V <sub>RMS</sub> | 1.2                           | 1.3                     |
| 240A45       | 240                     | 45*                           | 650                       | 33K                                    | 85VAC (280V allowed)   | 10 VAC                  | 600                             | 1.6 volts                   | 14 mA                            | 24–280                             | 1750                               | 4,000V <sub>RMS</sub> | 0.67                          | 0.9                     |

Notes: \* Ambient temperature will affect the current rating. For details, see the Thermal Ratings chart.

\*\* Operating Frequency: 25 to 65 Hz (operates at 400 Hz with 6 times the offstate leakage)

\*\*\* θ<sub>jc</sub> = Thermal resistance from internal junction to base. Maximum internal junction temperature is 110 °C.

### Connection Diagram, DC Power Series

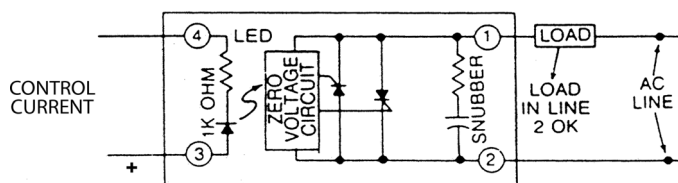

Control Current varies with control voltage. For details, see “Control Current Calculation” on page 17.

## 120/240/380 Volt (cont.)

### Surge Current Data

| Time (Seconds) | Time* (Cycles) | 3-Amp Peak Amps | 10-Amp Peak Amps | 25-Amp Peak Amps | 45-Amp Peak Amps |
|----------------|----------------|-----------------|------------------|------------------|------------------|
| 0.017          | 1              | 85              | 110              | 250              | 650              |
| 0.050          | 3              | 66              | 85               | 175              | 420              |
| 0.100          | 6              | 53              | 70               | 140              | 320              |
| 0.200          | 12             | 45              | 60               | 112              | 245              |
| 0.500          | 30             | 37              | 50               | 80               | 175              |
| 1              | 60             | 31              | 40               | 67               | 134              |
| 2              | 120            | 28              | 33               | 53               | 119              |
| 3              | 180            | 27              | 32               | 49               | 98               |
| 4              | 240            | 26              | 31               | 47               | 95               |
| 5              | 300            | 25              | 30               | 45               | 91               |
| 10             | 600            | 24              | 28               | 42               | 84               |

Note: \*60 Hz.

### Connection Diagram, AC Power Series

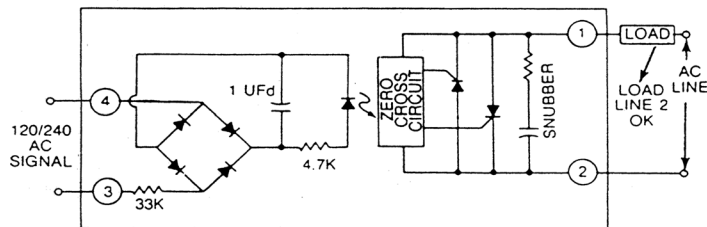

### Dimensional Drawings

NOTE: All dimensions are nominal. We do not recommend mounting the terminal side of the SSR to a flat PCB (printed circuit board) or other flat surface, because there may be some variation in terminal height from one terminal to another and from one SSR to another.

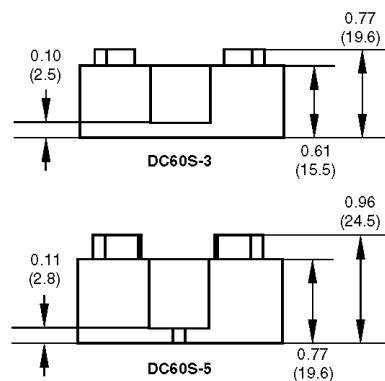
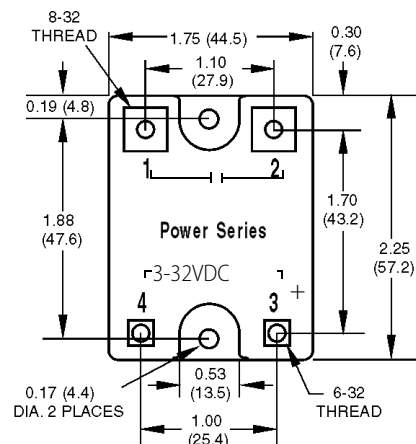

Side view: Part numbers  
DC60S3, 120D3, and  
240D3 only

Side view: All other  
part numbers

### Thermal Ratings

Ambient temperature will affect the current rating.

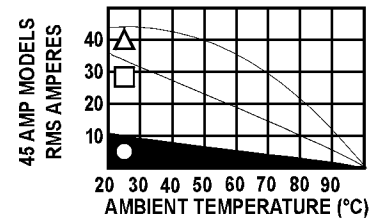
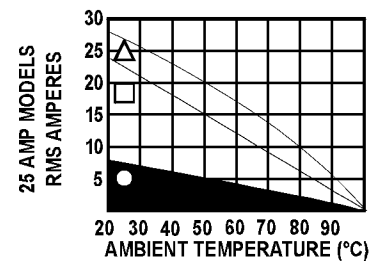
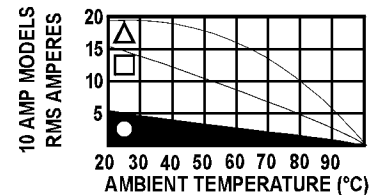
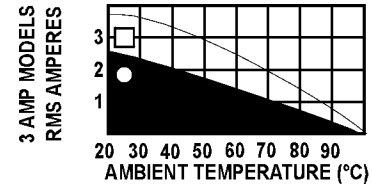

- FREE AIR
- MOUNTED ON A HEATSINK WITH 2 °C/WATT RATING
- MOUNTED ON A HEATSINK WITH 1 °C/WATT RATING

## 480/575 Volt

| Model Number | Nominal AC Line Voltage | Nominal Current Rating (Amps) | 1 cycle Surge (Amps) Peak | Nominal Signal Input Resistance (Ohms) | Signal Pick-up Voltage | Signal Drop-out Voltage | Peak Repetitive Voltage Maximum | Maximum Output Voltage Drop | Off-State Leakage (mA) Maximum** | Operating Voltage Range (Volts AC) | I <sup>2</sup> t Rating t=8.3 (ms) | Isolation Voltage     | θ <sub>jc</sub> *** (°C/Watt) | Dissipation (Watts/Amp) |
|--------------|-------------------------|-------------------------------|---------------------------|----------------------------------------|------------------------|-------------------------|---------------------------------|-----------------------------|----------------------------------|------------------------------------|------------------------------------|-----------------------|-------------------------------|-------------------------|
| 480D10-12    | 480                     | 10*                           | 110                       | 1000                                   | 3VDC (32V allowed)     | 1 VDC                   | 1200                            | 3.2 volts                   | 11 mA                            | 100-530                            | 50                                 | 4,000V <sub>RMS</sub> | 1.2                           | 2.5                     |
| 480D15-12    | 480                     | 15*                           | 150                       | 1000                                   | 3VDC (32V allowed)     | 1 VDC                   | 1200                            | 3.2 volts                   | 11 mA                            | 100-530                            | 50                                 | 4,000V <sub>RMS</sub> | 1.2                           | 2.5                     |
| 480D25-12    | 480                     | 25*                           | 250                       | 1000                                   | 3VDC (32V allowed)     | 1 VDC                   | 1000                            | 1.6 volts                   | 11 mA                            | 100-530                            | 250                                | 4,000V <sub>RMS</sub> | 1.3                           | 1.3                     |
| 480D45-12    | 480                     | 45*                           | 650                       | 1000                                   | 3VDC (32V allowed)     | 1 VDC                   | 1000                            | 1.6 volts                   | 11 mA                            | 100-530                            | 1750                               | 4,000V <sub>RMS</sub> | 0.67                          | 0.9                     |
| 575D15-12    | 575                     | 15*                           | 150                       | 1000                                   | 3VDC (32V allowed)     | 1 VDC                   | 1200                            | 3.2 volts                   | 15 mA                            | 100-600                            | 90                                 | 4,000V <sub>RMS</sub> | 1.2                           | 2.5                     |
| 575D45-12    | 575                     | 45*                           | 650                       | 1000                                   | 3VDC (32V allowed)     | 1 VDC                   | 1000                            | 1.6 volts                   | 15 mA                            | 100-600                            | 1750                               | 4,000V <sub>RMS</sub> | 0.67                          | 0.9                     |
| 575DI45-12   | 575                     | 45*                           | 650                       | 730                                    | 3VDC (32V allowed)     | 1 VDC                   | 1000                            | 1.6 volts                   | 15 mA                            | 100-600                            | 1750                               | 4,000V <sub>RMS</sub> | 0.67                          | 0.9                     |

Notes: \* Ambient temperature will affect the current rating. For details, see the Thermal Ratings chart.

\*\* Operating Frequency: 25 to 65 Hz (operates at 400 Hz with 6 times the offstate leakage)

\*\*\* θ<sub>jc</sub> = Thermal resistance from internal junction to base. Maximum internal junction temperature is 110 °C.

### Surge Current Data

| Time Second | Time*** (Cycles) | 10-Amp Peak Amps | 15-Amp Peak Amps | 25-Amp Peak Amps | 45-Amp Peak Amps |
|-------------|------------------|------------------|------------------|------------------|------------------|
| 0.017       | 1                | 110              | 150              | 250              | 650              |
| 0.050       | 3                | 85               | 140              | 175              | 420              |
| 0.100       | 6                | 70               | 110              | 140              | 320              |
| 0.200       | 12               | 60               | 90               | 112              | 245              |
| 0.500       | 30               | 50               | 70               | 80               | 175              |
| 1           | 60               | 40               | 55               | 67               | 134              |
| 2           | 120              | 33               | 49               | 53               | 119              |
| 3           | 180              | 32               | 47               | 49               | 98               |
| 4           | 240              | 31               | 43               | 47               | 95               |
| 5           | 300              | 30               | 40               | 45               | 91               |
| 10          | 600              | 28               | 35               | 42               | 84               |

Note: \*\*\*60 Hz

### Thermal Ratings

Ambient temperature will affect the current rating.

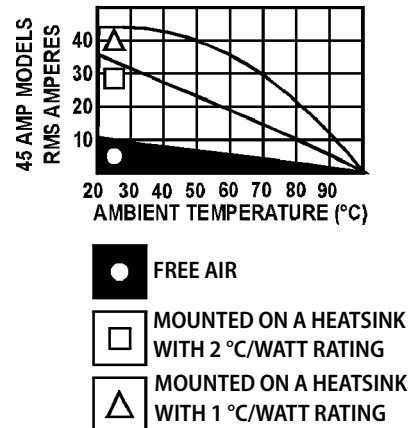



## 480/575 Volt (cont)

### Dimensional Drawings

NOTE: All dimensions are nominal. We do not recommend mounting the terminal side of the SSR to a flat PCB (printed circuit board) or other flat surface, because there may be some variation in terminal height from one terminal to another and from one SSR to another.

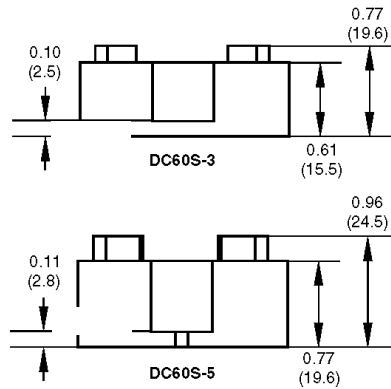
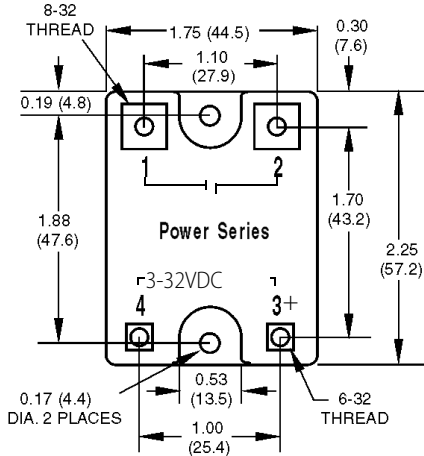

Side view: Part numbers  
DC60S3, 120D3, and  
240D3 only

Side view: All other  
part numbers

## Z SERIES SPECIFICATIONS

### AC Power: 120/240 Volt

The Z Series employs a unique heat transfer system that makes it possible for Opto 22 to deliver a low-cost, 10-amp, solid-state relay in an all-plastic case. The push-on tool-free quick-connect

terminals make the Z Series ideal for high-volume OEM applications. Operating temperature is  $-40^{\circ}\text{C}$  to  $100^{\circ}\text{C}$ . (Ambient temperature will affect the current rating.)

|                                                                                     | Z120D10                | Z240D10                |
|-------------------------------------------------------------------------------------|------------------------|------------------------|
| Nominal AC Line Voltage Nominal                                                     | 120                    | 240                    |
| Current Rating (Amps)                                                               | 10*                    | 10*                    |
| 1 cycle Surge (Amps) Peak                                                           | 110                    | 110                    |
| Nominal Signal Input Resistance (Ohms)                                              | 1000                   | 1000                   |
| Signal Pick-up Voltage                                                              | 3VDC (32V allowed)     | 3VDC (32V allowed)     |
| Signal Drop-out Voltage                                                             | 1 VDC                  | 1 VDC                  |
| Peak Repetitive Voltage Maximum                                                     | 600                    | 600                    |
| Maximum Output Voltage Drop                                                         | 1.6 volts              | 1.6 volts              |
| Off-State Leakage (mA) Maximum**                                                    | 6 mA                   | 12 mA                  |
| Operating Voltage Range (Volts AC)                                                  | 12–140                 | 24–280                 |
| $I^2t$ Rating $t=8.3$ (ms)                                                          | 50                     | 50                     |
| Isolation Voltage                                                                   | 4,000 $V_{\text{RMS}}$ | 4,000 $V_{\text{RMS}}$ |
| $\theta_{\text{jc}}$ *** ( $^{\circ}\text{C}/\text{Watt}$ ) Dissipation (Watts/Amp) | 4                      | 4                      |

Notes: \* Ambient temperature will affect the current rating. For details, see the Thermal Ratings chart.  
 \*\* Operating Frequency: 25 to 65 Hz (operates at 400 Hz with 6 times the offstate leakage).  
 \*\*\*  $\theta_{\text{jc}}$  = Thermal resistance from internal junction to base. Maximum internal junction temperature is  $110^{\circ}\text{C}$ .

NOTE: Part number Z240D10-17 is a replacement part only. Its specifications are identical to Z240D10.

AC Power: 120/240 Volt (cont.)

### Thermal Ratings

Ambient temperature will affect the current rating.

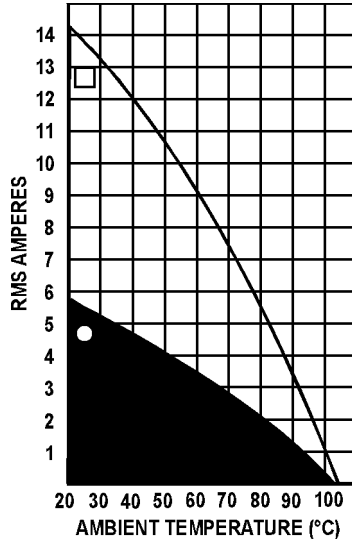

-  FREE AIR
-  MOUNTED ON A HEATSINK WITH 2°C/WATT RATING

### Surge Current Data

| Time Second | Time* (Cycles) | Peak Amps |
|-------------|----------------|-----------|
| 0.017       | 1              | 110       |
| 0.050       | 3              | 85        |
| 0.100       | 6              | 70        |
| 0.200       | 12             | 60        |
| 0.500       | 30             | 50        |
| 1           | 60             | 40        |
| 2           | 120            | 33        |
| 3           | 180            | 32        |
| 4           | 240            | 31        |
| 5           | 300            | 30        |
| 10          | 600            | 28        |

Note: \*60 Hz

### Connection Diagram

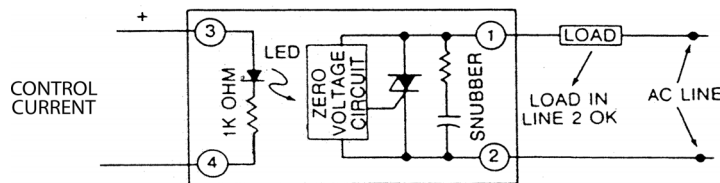

Control Current varies with control voltage. For details, see "Control Current Calculation" on page 17.

### Dimensional Drawings

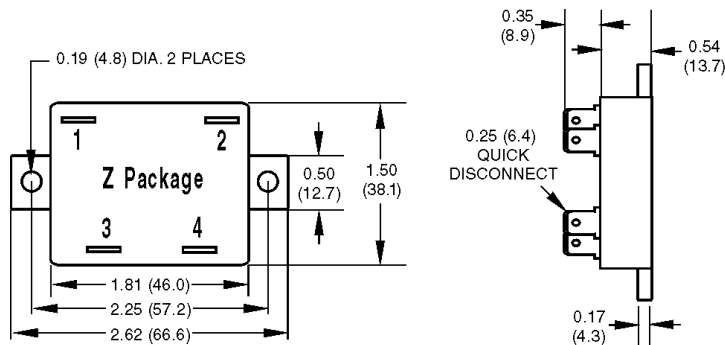

*NOTE: All dimensions are nominal. We do not recommend mounting the terminal side of the SSR to a flat PCB (printed circuit board) or other flat surface, because there may be some variation in terminal height or alignment from one terminal to another and from one SSR to another.*



## PRINTED CIRCUIT SERIES SPECIFICATIONS

### AC Power: MP and P Series

The MP Series packaging is designed with a minimum footprint to allow maximum relay density on the printed circuit board.  
The P Series power relays provide low-profile for 0.5-inch (12.7 mm)

center mounting on printed circuit boards.  
Operating temperature: -40 °C to 100 °C. (Ambient temperature will affect the current rating.)

|                                        | MP120D2<br>or P120D2                 | MP120D4<br>or P120D4                   | MP240D2<br>or P240D2                  | MP240D4<br>or P240D4                    | MP380D4                                 |
|----------------------------------------|--------------------------------------|----------------------------------------|---------------------------------------|-----------------------------------------|-----------------------------------------|
| Nominal AC Line Voltage                | 120                                  | 120                                    | 240                                   | 240                                     | 380                                     |
| Nominal Current Rating (Amps)          | 2*                                   | 4*                                     | 2*                                    | 4*                                      | 4*                                      |
| 1 cycle Surge (Amps) Peak              | 20                                   | 85                                     | 20                                    | 85                                      | 85                                      |
| Nominal Signal Input Resistance (Ohms) | 1000                                 | 1000                                   | 1000                                  | 1000                                    | 1000                                    |
| Signal Pick-up Voltage                 | 3VDC****<br>(24V allowed)            | 3VDC****<br>(24V allowed)              | 3VDC****<br>(24V allowed)             | 3VDC****<br>(24V allowed)               | 3VDC****<br>(24V allowed)               |
| Signal Drop-out Voltage                | 1 VDC                                | 1 VDC                                  | 1 VDC                                 | 1 VDC                                   | 1 VDC                                   |
| Peak Repetitive Voltage Maximum        | 600                                  | 600                                    | 600                                   | 600                                     | 800                                     |
| Maximum Output Voltage Drop            | 1.6 volts                            | 1.6 volts                              | 1.6 volts                             | 1.6 volts                               | 1.6 volts                               |
| Off-State Leakage mA Maximum**         | 5 mA                                 | 5 mA                                   | 5 mA                                  | 5 mA                                    | 5 mA                                    |
| Operating Voltage Range (Volts AC)     | 12-140                               | 12-140                                 | 24-280                                | 24-280                                  | 24-420                                  |
| I <sup>2</sup> t Rating t=8.3 (ms)     | 2                                    | 30                                     | 2                                     | 30                                      | 30                                      |
| Isolation Voltage                      | 4,000 V <sub>RMS</sub>               | 4,000 V <sub>RMS</sub>                 | 4,000 V <sub>RMS</sub>                | 4,000 V <sub>RMS</sub>                  | 4,000 V <sub>RMS</sub>                  |
| θ <sub>jc</sub> *** °C/Watt            | 20                                   | 6.5                                    | 20                                    | 6.5                                     | 6.5                                     |
| Dissipation Watts/Amp                  | 1.2                                  | 1.2                                    | 1.2                                   | 1.2                                     | 1.2                                     |
| Rating (Motor Load)                    | 1 FLA at 120 VAC<br>6 LRA at 120 VAC | 2.5 FLA at 240 VAC<br>6 LRA at 240 VAC | 1 FLA at 120 VAC<br>15 LRA at 120 VAC | 2.5 FLA at 240 VAC<br>15 LRA at 240 VAC | 2.5 FLA at 380 VAC<br>15 LRA at 380 VAC |

**Notes:** \* Ambient temperature will affect the current rating. For details, see the Thermal Ratings chart.

\*\* Operating Frequency: 25 to 65 Hz (operates at 400 Hz with 6 times the offstate leakage)

\*\*\* θ<sub>jc</sub> = Thermal resistance from internal junction to base. Maximum internal junction temperature is 110 °C.

\*\*\*\* = P Series 32 volts maximum.

### Connection Diagram

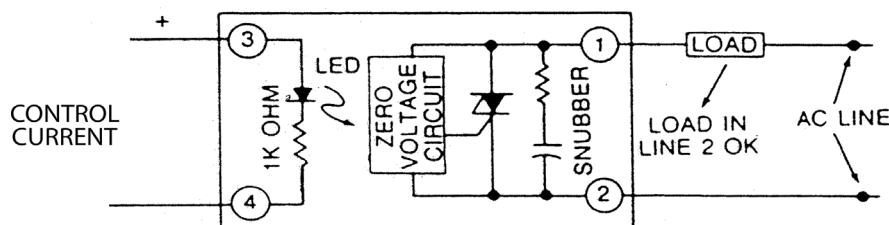

NOTE: Part numbers ending in -17 are replacement parts only. Their specifications are identical to the same part number without the -17. For example, P240D4-17 is identical to P240D4.

Control Current varies with control voltage. For details, see "Control Current Calculation" on page 17.

## AC Power: MP and P Series (cont.)

### Surge Current Data

| Time (Seconds) | Time* (Cycles) | 2-Amp Peak Amps | 4-Amp Peak Amps |
|----------------|----------------|-----------------|-----------------|
| 0.017          | 1              | 20              | 85              |
| 0.050          | 3              | 18              | 66              |
| 0.100          | 6              | 15              | 53              |
| 0.200          | 12             | 11              | 45              |
| 0.500          | 30             | 9               | 37              |
| 1              | 60             | 8.5             | 31              |
| 2              | 120            | 8               | 28              |
| 3              | 180            | 7.5             | 27              |
| 4              | 240            | 7               | 26              |
| 5              | 300            | 6.5             | 25              |
| 10             | 600            | 6               | 24              |

Note: \*60 Hz

### Dimensional Drawings

NOTE: All dimensions are nominal.

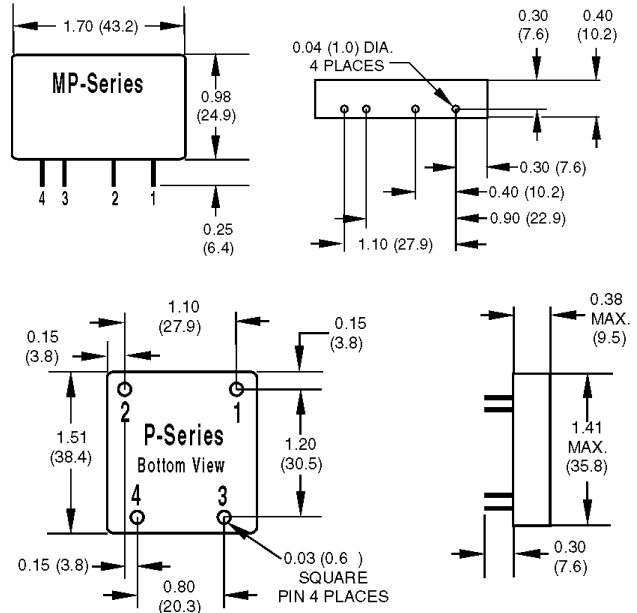

### Thermal Ratings

Ambient temperature will affect the current rating.

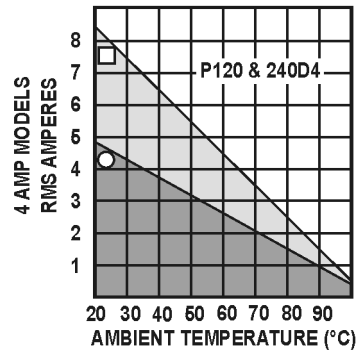
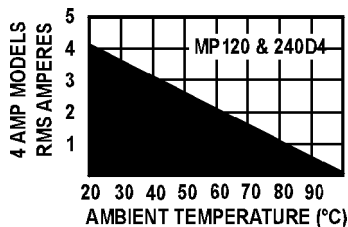
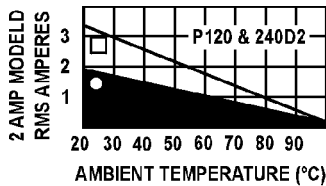
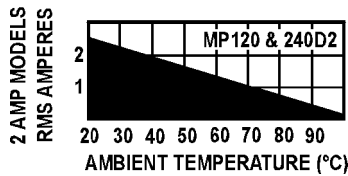

-  FREE AIR
-  MOUNTED ON A HEAT SINK WITH 2° C/WATT RATING

## DC SWITCHING SERIES SPECIFICATIONS

|                               | DC60P or DC60MP             | DC200P or DC200MP           | DC60S3                    | DC60S5                    |
|-------------------------------|-----------------------------|-----------------------------|---------------------------|---------------------------|
| Operating Voltage Range       | 5–60 VDC                    | 5–200 VDC                   | 5–60 VDC                  | 5–60 VDC                  |
| Forward Voltage Drop          | 1.5 volts at 3 amps         | 1.5 volts at 1 amp          | 1.5 volts at 3 amps       | 1.5 volts at 5 amps       |
| Nominal Current Rating (Amps) | 3*                          | 1*                          | 3*                        | 5*                        |
| Off-State Blocking            | 60 VDC                      | 250 VDC                     | 60 VDC                    | 60 VDC                    |
| Signal Pickup Voltage         | 3 VDC<br>32 Volts** allowed | 3 VDC<br>32 Volts** allowed | 3 VDC<br>32 Volts allowed | 3 VDC<br>32 Volts allowed |
| Signal Dropout Voltage        | 1 VDC                       | 1 VDC                       | 1 VDC                     | 1 VDC                     |
| Signal Input Impedance        | 1,000 ohms                  | 1,000 ohms                  | 1,000 ohms                | 1,000 ohms                |
| 1 Second Surge                | 5 amps                      | 2 amps                      | 5 amps                    | 10 amps                   |
| Operating Temp. Range         | –40 °C to 100 °C            | –40 °C to 100 °C            | –40 °C to 100 °C          | –40 °C to 100 °C          |
| Isolation Voltage             | 4,000 V <sub>RMS</sub>      | 4,000 V <sub>RMS</sub>      | 4,000 V <sub>RMS</sub>    | 4,000 V <sub>RMS</sub>    |
| Off-State Leakage             | 1 mA maximum                | 1 mA maximum                | 1 mA maximum              | 1 mA maximum              |
| Package Type                  | P/MP series                 | P/MP series                 | Power series              | Power series              |
| Turn-on Time                  | 100 usec                    | 100 usec                    | 100 usec                  | 100 usec                  |
| Turn-off Time                 | 750 usec                    | 750 usec                    | 750 usec                  | 750 usec                  |

**Notes:** \* Ambient temperature will affect the current rating. For details, see the Thermal Ratings chart.

\*\* MP series maximum allowed control signal is 24 VDC.

*NOTE: When controlling an inductive load, like a solenoid or coil, a commutating diode must be used. Install the commutating diode across the terminals of the load (not the SSR terminals). This will protect the SSR from damage caused by voltage spikes when turning off the load.*

### Model DC60MP Basic Schematic (also applies to the other SSRs on this page)

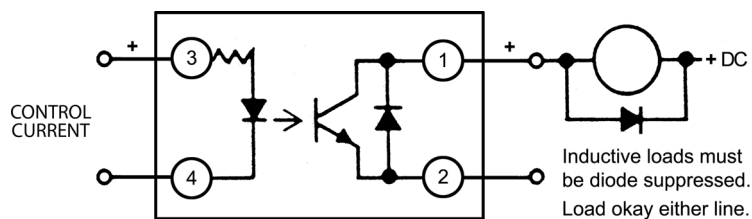

Control Current varies with control voltage. For details, see "Control Current Calculation" on page 17.

### Thermal Ratings

Ambient temperature will affect the current rating.

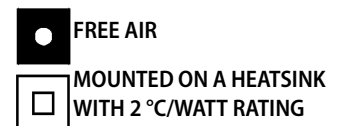
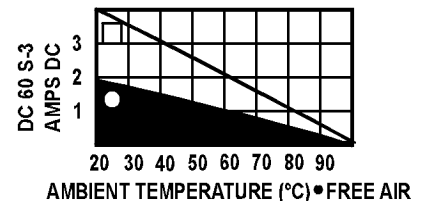
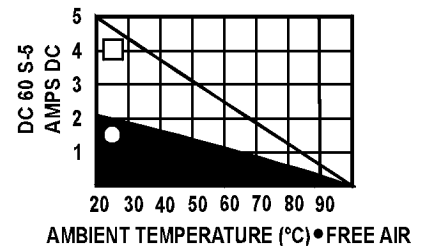
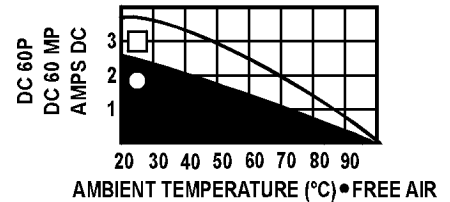
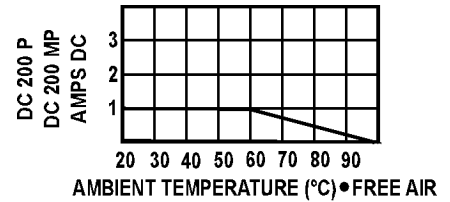

## Dimensional Drawings

NOTE: All dimensions are nominal. We do not recommend mounting the terminal side of a Power Series or Z series SSR to a flat PCB (printed circuit board) or other flat surface, because there may be some variation in terminal height or alignment from one terminal to another and from one SSR to another. For mounting on PCBs, use the MP series or P series.

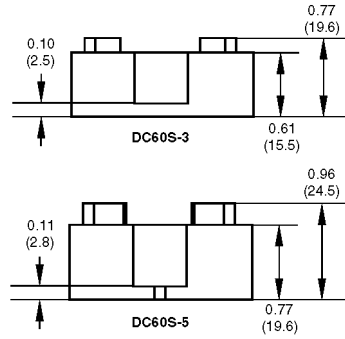
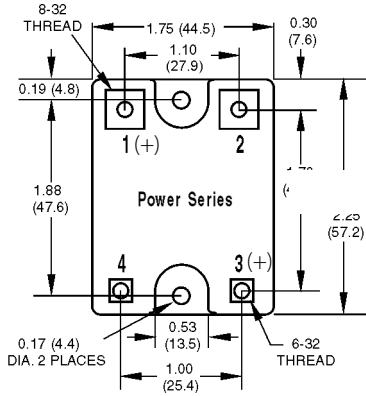

Side view: Part numbers DC60S3, 120D3, and 240D3 only

Side view: All other part numbers

Power Series SSR with SSR-HS Heat Sink, top view

Power Series SSR with SSR-HS Heat Sink, side view

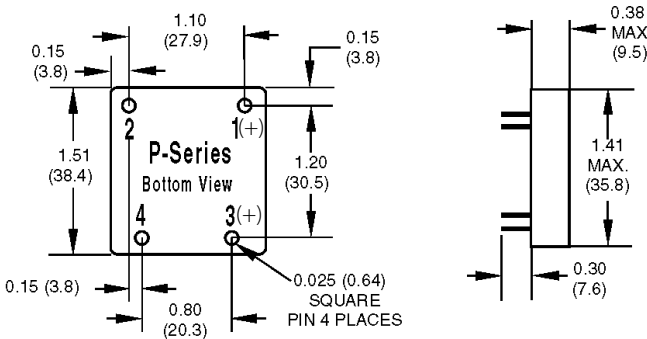
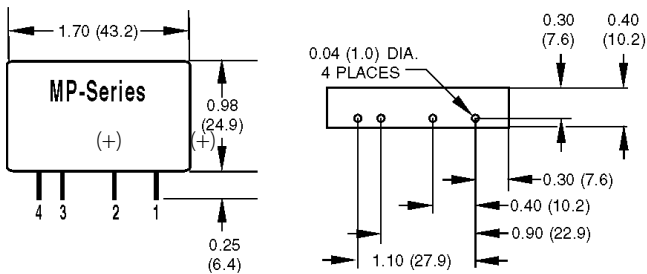
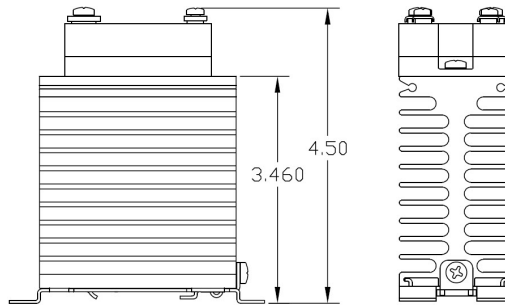
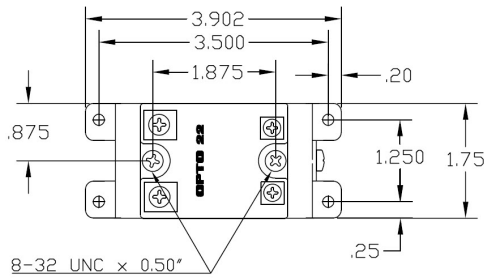

## HS SERIES SPECIFICATIONS

The HS Series features an integrated heatsink, which makes them so cool. Because there is less thermal resistance internal to the unit than in a standard SSR mounted to the same heat sink, heat dissipates more easily. The built-in heatsink means you don't have to select a heatsink, and installation is much easier. Each HS-series SSR has built-in hardware for screw mounting and a built-in DIN-rail adapter clip for mounting to a 35mm DIN rail.

| Model Number                           | 240D30-HS<br>[Obsolete] | 480D25-HS<br>[Obsolete] | 575D30-HS<br>[Obsolete] |
|----------------------------------------|-------------------------|-------------------------|-------------------------|
| Nominal AC Line Voltage                | 240                     | 480                     | 575                     |
| Operating Voltage Range (Volts AC)     | 24–280                  | 100–530                 | 100–600                 |
| Peak Repetitive Voltage Maximum        | 600                     | 1000                    | 1200                    |
| Off-State Leakage (mA) Maximum*        | 5 mA                    | 10 mA                   | 12 mA                   |
| Nominal Output Voltage Drop (RMS)      | 1.0 volts               | 1.0 volts               | 1.0 volts               |
| Nominal Current Rating (Amps)          | 30**                    | 25**                    | 30**                    |
| 1 cycle Surge (Amps) Peak              | 610                     | 610                     | 610                     |
| I <sup>2</sup> t Rating t=8.3 (ms)     | 1550                    | 1550                    | 1550                    |
| Isolation Voltage (transient 4KV)      | 2,500V <sub>RMS</sub>   | 2,500V <sub>RMS</sub>   | 2,500V <sub>RMS</sub>   |
| Dissipation (Nominal Watts/Amp)        | 1.0                     | 1.0                     | 1.0                     |
| Signal Pick-up Voltage                 | 4VDC<br>(32V allowed)   | 4VDC<br>(32V allowed)   | 4VDC<br>(32V allowed)   |
| Signal Drop-out Voltage                | 1 VDC                   | 1 VDC                   | 1 VDC                   |
| Nominal Signal Input Resistance (Ohms) | 730                     | 1000                    | 1000                    |
| θ <sub>ja</sub> ** (°C/Watt)           | 2.2                     | 2.2                     | 2.2                     |

Notes: \* Operating Frequency: 25 to 65 Hz (operates at 400 Hz with 6 times the offstate leakage)

\*\* Ambient temperature will affect the current rating. For details, see the associated Thermal Ratings chart.

\*\*\* θ<sub>ja</sub> = Thermal resistance from internal junction to base. Maximum internal junction temperature is 110 °C.

### Surge Current Data, Peak Amps

| Time Second | 60HZ | 50HZ |
|-------------|------|------|
| 0.0167      | 610  | 580  |
| 0.05        | 394  | 375  |
| 0.1         | 300  | 386  |
| 0.2         | 230  | 219  |
| 0.5         | 164  | 156  |
| 1           | 126  | 120  |
| 2           | 112  | 106  |
| 3           | 92   | 87   |
| 4           | 89   | 85   |
| 5           | 85   | 81   |
| 10          | 79   | 75   |

## HS-SERIES (CONT.)

### Thermal Ratings

Ambient temperature will affect the current rating.

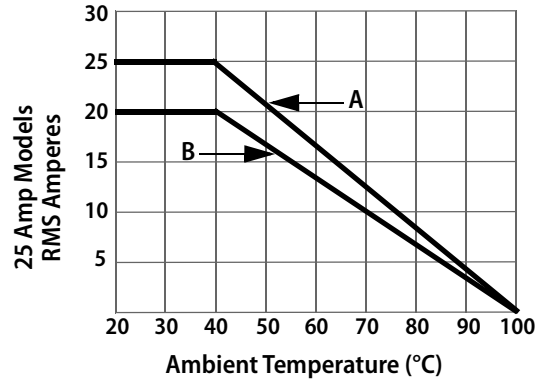
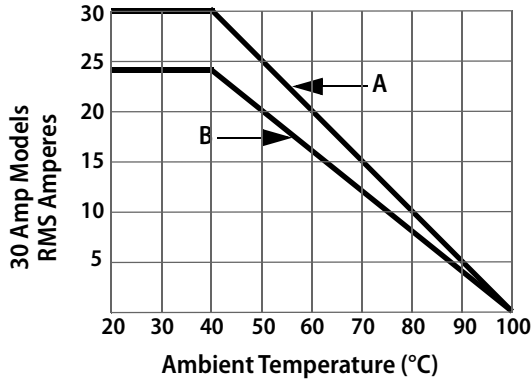

**A:** Single relay or with 0.75" spacing between relays. Derate above 40 °C; subtract 0.5 amp/°C.

**B:** Three relays side by side with 0.25" spacing. All relays with the same load. Derate above 40 °C; subtract 0.4 amp/°C.

*NOTE: This data is for SSRs mounted to a horizontal surface. To take advantage of the cooling effect of natural air flow, we recommend mounting HS-series SSRs to a vertical surface with the Opto 22 logo right side up as shown here.*

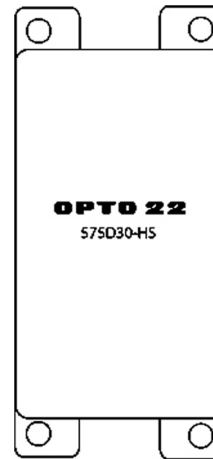

### Dimensional Drawing

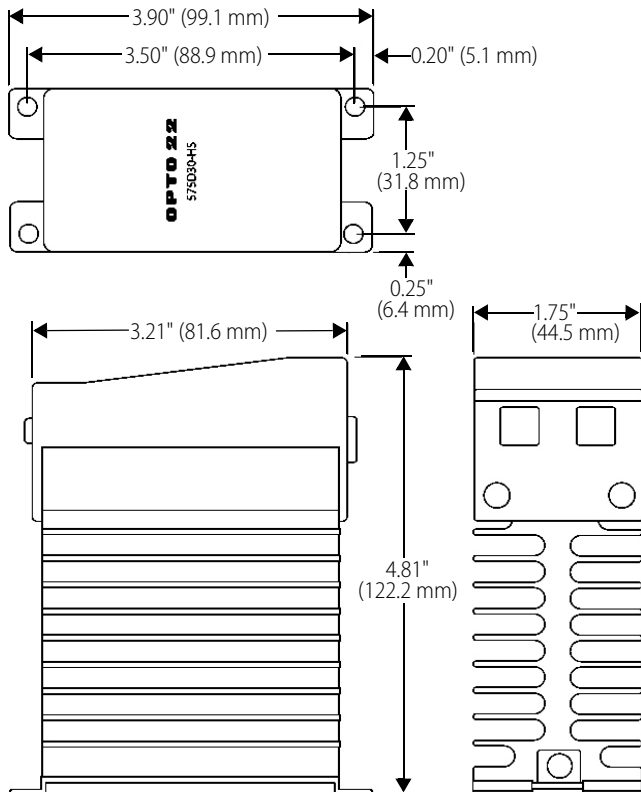



## APPLICATIONS: TIPS

### Heat Sink Calculation

Like all semiconductor devices, SSR current ratings must be based on maximum internal junction temperature. All Opto 22 SSRs operate conservatively at maximum internal junction temperatures of 110 °C. Use the equation below to calculate the maximum allowable heat sink thermal resistance for your application. It is good engineering practice to provide a margin for error instead of running the application right at the limits. If your application is near the thermal limit, it can be helpful to add a fan to move air across the heat sink.

$$\text{Heat Sink Max Thermal Resistance (}^{\circ}\text{C/Watt)} = \frac{\left[ \text{SSR Max allowed internal junction temp} - \text{Max Ambient Temp} - \left[ \text{Max Load Current} \times \text{SSR Heat Dissipation Factor} \times \text{SSR Thermal Resistance} \right] \right]}{\left[ \text{Max Load Current} \times \text{SSR Heat Dissipation Factor} \right]}$$

**IMPORTANT:** Thermally conductive grease must be used between the relay base and the heat sink.

### Sample Calculation 1

120-volt, 20-amp load; 50 °C ambient air temperature

Model: 120D25 SSR.

See the last two columns of the table on [page 4](#) for *thermal resistance* and *dissipation* values for the 120D25. Also, see the note at the bottom of the table.

Dissipation: 1.3 watts/amp

Thermal resistance: 1.2 °C/watt

Maximum junction temperature: 110 °C

The calculation would be as follows:

| Example for 120D25                         |   |                                                                | Units     |
|--------------------------------------------|---|----------------------------------------------------------------|-----------|
| Max Ambient Temp                           | = | 50.00                                                          | ° C       |
| Max Load Current                           | = | 20.00                                                          | Amps      |
| SSR Heat Dissipation Factor                | = | 1.30                                                           | Watts/Amp |
| SSR Thermal Resistance                     | = | 1.20                                                           | ° C/Watt  |
| SSR Max allowed internal junction temp     | = | 110.00                                                         | ° C       |
| Heat Sink Max Thermal Resistance (°C/Watt) | = | $(110 - 50 - (20 \times 1.3 \times 1.2))$<br>$(20 \times 1.3)$ | ° C/Watt  |
| Heat Sink Max Thermal Resistance (°C/Watt) | = | 28.8<br>26                                                     | ° C/Watt  |
| Heat Sink Max Thermal Resistance (°C/Watt) | = | 1.1                                                            | ° C/Watt  |

From Data Sheet

This calculation indicates that you should select a heat sink with a thermal resistance of less than 1.1 °C/watt.

## Sample Calculation 2

240-volt, 18-amp load, 25 °C ambient air temperature

Model: 240D45

See the last two columns of the table on [page 4](#) for thermal resistance and dissipation values for the 240D45. Also, see the note at the bottom of the table.

Dissipation: 0.9 watts/amp

Thermal resistance: 0.67 °C/watt

Maximum junction temperature: 110 °C

The calculation would be as follows:

| Example for 240D45                         |   |                                                                    | Units     |
|--------------------------------------------|---|--------------------------------------------------------------------|-----------|
| Max Ambient Temp                           | = | 25.00                                                              | ° C       |
| Max Load Current                           | = | 18.00                                                              | Amps      |
| SSR Heat Dissipation Factor                | = | 0.90                                                               | Watts/Amp |
| SSR Thermal Resistance                     | = | 0.67                                                               | ° C/Watt  |
| SSR Max allowed internal junction temp     | = | 110.00                                                             | ° C       |
| Heat Sink Max Thermal Resistance (°C/Watt) | = | $\frac{(110 - 25 - (18 \times 0.9 \times 0.67))}{(18 \times 0.9)}$ | ° C/Watt  |
| Heat Sink Max Thermal Resistance (°C/Watt) | = | 74.146                                                             | ° C/Watt  |
| Heat Sink Max Thermal Resistance (°C/Watt) | = | 16.2                                                               | ° C/Watt  |
| Heat Sink Max Thermal Resistance (°C/Watt) | = | 4.6                                                                | ° C/Watt  |

From Data Sheet

This calculation indicates that you should select a heat sink with a thermal resistance of less than 4.6 °C/watt.

## Duty Cycle Calculation

When solid-state relays are operated in an on/off mode, it may be advantageous to calculate the RMS value of the current through the SSR for heat sinking or determining the proper current rating of the SSR for the given application.

$I_{RMS}$  = RMS value of load or SSR

$T_1$  = Time current is on

$T_2$  = Time current is off

$I_{ON}$  = RMS value of load current during on period

$$I_{RMS} = \sqrt{\frac{(I_{ON})^2 \times T_1}{T_1 + T_2}}$$

## Transformer Loads

Careful consideration should be given to the selection of the proper SSR for driving a given transformer. Transformers are driven from positive saturation of the iron core to negative saturation of the core each half cycle of the alternating voltage. Large inrush currents can occur during the first half cycle of line voltage if a zero-voltage SSR happens to turn on during the positive half cycle of voltage when the core is already in positive saturation. Inrush currents greater than 10 times rated transformer current can easily occur. The following table provides a guide for selecting the proper SSR for a given transformer rating.

| 120-Volt Transformers |               |
|-----------------------|---------------|
| SSR MODEL             | TRANSFORMER   |
| P or MP 120D2         | 100 VA        |
| Z120D10               | 500 VA        |
| 120D3                 | 100 VA        |
| P or MP 120D4         | 250 VA        |
| 120D10 or 120A10      | 500 VA        |
| 120D25 or 120A25      | 1 KVA         |
| 120D45                | 2 KVA         |
| 240-Volt Transformers |               |
| P or MP240D2          | 200 VA        |
| Z240D10               | 1 KVA         |
| 120D3                 | 200 VA        |
| P or MP240D4          | 500 VA        |
| 240D10 or 240A10      | 1 KVA         |
| 240D25 or 240A25      | 2 KVA         |
| 240D45                | 4 KVA         |
| 480-Volt Transformers |               |
| SSR MODEL             | TRANSFORMER   |
| 480D10-12             | 5-Amp Primary |
| 480D15-12             | 5-Amp Primary |

## Solenoid Valve and Contactor Loads

All Opto 22 SSRs are designed to drive inductive loads such as solenoid valves and electromechanical contactors. The built-in snubber in each SSR assures proper operation into inductive loads. The following table is a guide in selecting an SSR to drive a solenoid or contactor.

| 120-Volt Coils     |          |             |
|--------------------|----------|-------------|
| SSR CURRENT RATING | SOLENOID | CONTACTOR   |
| 2-Amp              | 1-Amp    | NEMA Size 4 |
| 4-Amp              | 3-Amp    | NEMA Size 7 |
| 240-Volt Coils     |          |             |
| SSR CURRENT RATING | SOLENOID | CONTACTOR   |
| 2-Amp              | 1-Amp    | NEMA Size 7 |
| 4-Amp              | 3-Amp    | NEMA Size 7 |

## Control Current Calculation

All Opto 22 DC-controlled SSRs have a control circuit consisting of 1000 ohms in series with an Optocoupler LED.

The LED will drop 1 volt, so the voltage across the internal resistor will be 1 volt less than the control voltage.

The control current ( $I_C$ ) can be calculated from the control voltage ( $V_C$ ) as follows:

$$I_C = (V_C - 1)/1000$$

Examples:

3 VDC control voltage:

$$I_C = (3 - 1)/1000 = 0.002 \text{ A (2 mA)}$$

32 VDC control voltage:

$$I_C = (32 - 1)/1000 = 0.031 \text{ A (31 mA)}$$

For control voltages above 32 VDC, an external resistor can be added in series with the SSR to limit the control current. Also, if the device driving the control current to the SSR is limited, you can limit the control current by using an external resistor ( $R_e$ ).

$$I_C = (V_C - 1) / (R_e + 1000)$$

$$R_e = [(V_C - 1) / (I_C)] - 1000$$

To limit the control current to 2 mA, this simplifies to:

$$R_e = 500 (V_C - 3)$$

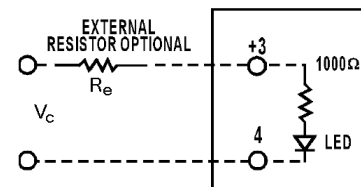

Opto 22 SSRs for controlling single-phase motors are shown in the following tables:

| 120-Volt Single-Phase Non-Reversing Motors |              |
|--------------------------------------------|--------------|
| SSR Model                                  | MOTOR RATING |
| P or MP120D2                               | 1 Amp        |
| Z120D10                                    | 1/4 HP       |
| 120D3                                      | 1-1/2 Amp    |
| P or MP120D4                               | 1-1/2 Amp    |
| 120D10 or 120A10                           | 1/4 HP       |
| 120D25 or 120A25                           | 1/3 HP       |
| 120D45                                     | 3/4 HP       |

| 240-Volt Single Phase Non-Reversing Motors |              |
|--------------------------------------------|--------------|
| SSR Model                                  | MOTOR RATING |
| P or MP240D2                               | 1 Amp        |
| Z240D10                                    | 1/4 HP       |
| 240D3                                      | 1-1/2 Amp    |
| P or MP240D4                               | 1-1/2 Amp    |
| 240D10 or 240A10                           | 1/3 HP       |
| 240D25 or 120A25                           | 1/2 HP       |
| 240D45                                     | 1-1/2 HP     |

| 120-Volt Single-Phase Reversing Motors |              |
|----------------------------------------|--------------|
| SSR Model                              | MOTOR RATING |
| P or MP240D2                           | 1 Amp        |
| Z240D10                                | 1/4 HP       |
| 240D3                                  | 1-1/2 Amp    |
| P or MP240D4                           | 1-1/2 Amp    |
| 240D10 or 240A10                       | 1/4 HP       |
| 240D25 or 120A25                       | 1/3 HP       |
| 240D45                                 | 3/4 HP       |

| 240-Volt Single-Phase Reversing Motors |              |
|----------------------------------------|--------------|
| SSR Model                              | MOTOR RATING |
| 480D10-12                              | 1/4 HP       |
| 480D15-12                              | 1/4 HP       |

## Solid-State Relays in Series

In applications requiring higher voltage, two Opto 22 SSRs may be operated in series for double the voltage rating. The built-in snubber in each SSR assures proper voltage sharing of the two SSRs in series. In the following diagram, two 240-volt, 45-amp SSRs are connected in series for operation on a 480-volt line. The control is shown with a parallel hook-up but it should be noted that a serial connection can also be implemented.

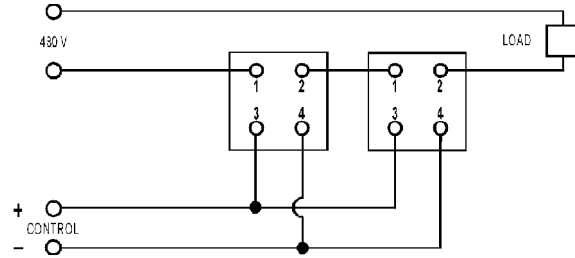

## Lamp Loads

Since all Opto 22 AC output SSRs use zero-voltage turn-on, they are ideal for driving incandescent lamps, because the initial inrush current into a cold filament is reduced. The life of the lamp is increased when switched by a zero-voltage turn-on SSR. The following table is a guide to selecting an Opto 22 SSR for switching a given incandescent lamp.

| 120 Volt Lamps     |             |
|--------------------|-------------|
| SSR CURRENT RATING | LAMP RATING |
| 2-Amp              | 100 Watt    |
| 4-Amp              | 400 Watt    |
| 10-Amp             | 1 Kilowatt  |
| 25-Amp             | 2 Kilowatt  |
| 45-Amp             | 3 Kilowatt  |
| 240 Volt Rating    |             |
| SSR CURRENT RATING | LAMP RATING |
| 2-Amp              | 200 Watt    |
| 4-Amp              | 800 Watt    |
| 10-Amp             | 2 Kilowatt  |
| 25-Amp             | 4 Kilowatt  |
| 45-Amp             | 6 Kilowatt  |

## Heater Loads

Care should be taken in selecting a SSR for driving a heater load if the load is cycled on and off in a continuous manner as might occur in a temperature control application. Constant cycling can cause thermal fatigue in the thyristor chip at the point where the chip bonds to the lead frame. Opto 22 employs a thick copper lead frame for mounting the SCR chips in the power series SSRs to eliminate thermal fatigue failures. In addition, Opto 22 recommends operating any SSR at 75% rated current for cycling heater loads to ensure complete reliability.

The following table is a guide to selecting the proper SSR for a given heater load.\*

| Nominal SSR Current Rating | Maximum Recommended Heater Current |
|----------------------------|------------------------------------|
| 2-Amp                      | 1½-Amp                             |
| 4-Amp                      | 2½-Amp                             |
| 10-Amp                     | 7½-Amp                             |
| 25-Amp                     | 18-Amp                             |
| 45-Amp                     | 35-Amp                             |
| 10 480V                    | 8-Amp                              |
| 10 480V                    | 8-Amp                              |

\* Ambient temperature will affect the current rating. For details, see the Thermal Ratings charts.

## Single-Phase Reversing Motor Control

The circuit diagram below illustrates a typical 1 Ø motor winding inductance and the phase shift capacitor can cause twice-line voltage to appear across the open SSR. A 240-volt SSR should be used for a 120-volt line. During the transition period when one SSR is turned on and the other SSR is going off, both SSRs may be on. In this case, the capacitor may discharge through the two SSRs, causing large currents to flow, which may destroy the SSRs. The addition of RL as shown will protect the SSRs from the short circuit capacitor discharge current.

$$\text{CALCULATE RL as: } RL = \frac{1.4 \text{ EAC}}{10 \times \text{SSR full load rating}}$$

**EXAMPLE: 10 amp SSR  
120 V AC Line**

$$RL = \frac{1.4 \times 120}{10 \times 10} = 1.7 \text{ ohm}$$

## Single-Phase Reversing Motor Control (cont.)

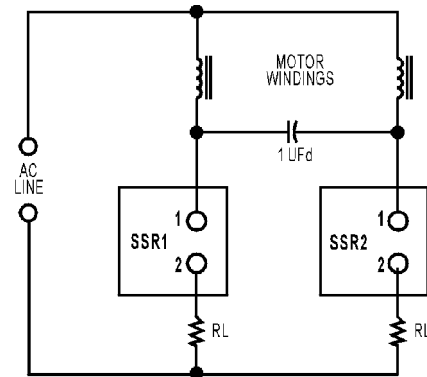

The resistors are unnecessary if the control circuit is designed to ensure that one SSR is off before the other SSR is on.

## Three-Phase Motor Control



Three-phase motors may be controlled by solid-state relays as shown. A third SSR as shown is optional, but not necessary. The control windings may be connected in series or parallel. Care should be taken to ensure that the surge current drawn by the motor does not exceed the surge current rating of the SSR.

| 240 Volt Three-Phase Motor |        | 480 Volt Three-Phase Motors |        |
|----------------------------|--------|-----------------------------|--------|
| SSR MODEL                  | MOTOR  | SSR MODEL                   | MOTOR  |
| SSR MODEL                  | MOTOR  | 480D10-12                   | 1-½ HP |
| Z240D10                    | 3/4 HP | 480D15-12                   | 1-½ HP |
| 240D10                     | 3/4 HP |                             |        |
| 240A10                     | 3/4 HP |                             |        |
| 240D25                     | 2 HP   |                             |        |
| 240A25                     | 2 HP   |                             |        |
| 240D45                     | 3 HP   |                             |        |

## Three-Phase Reversing Motor Control

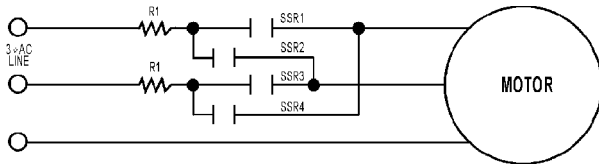

Three-phase reversing motor control can be implemented with four SSRs as shown in the connection diagram. The SSRs work in pairs with SSR1 and SSR3 operated for rotation in one direction and SSR2 and SSR4 operated for rotation in the reverse direction. The resistor R1 as shown in the connection diagram protects against line-to-line shorts if SSR1 and SSR4 or SSR3 and SSR2 are on at the same time during the reversing transition period. Use the following table as a guide to the proper selection of an SSR for this application.

| Opto 22 Relay | Motor Full Load Rating | Resistor for 120V line | Resistor for 240V line |
|---------------|------------------------|------------------------|------------------------|
| 3-Amp         | 1.25-Amp               | 4 ohm 50 W             | 8 ohm 50 W             |
| 10-Amp        | 5-Amp                  | 1 ohm 100 W            | 2 ohm 100 W            |
| 25-Amp        | 8-Amp                  | .5 ohm 100 W           | 1 ohm 100 W            |
| 45-Amp        | 16-Amp                 | .25 ohm 150 W          | .5 ohm 150 W           |
| 15-Amp        | 5-Amp                  | 1 ohm 100 W            | 2 ohm 100 W            |

## FAQ: SSR APPLICATIONS

### Q : What is a solid-state relay?

A: A solid-state relay (SSR) is a semiconductor device that can be used in place of a mechanical relay to switch electricity to a load in many applications. Solid-state relays are purely electronic, normally composed of a low current “control” side (equivalent to the coil on an electromechanical relay) and a high-current load side (equivalent to the contact on a conventional relay). SSRs typically also feature electrical isolation to several thousand volts between the control and load sides. Because of this isolation, the load side of the relay is actually powered by the switched line; both line voltage and a load (not to mention a control signal) must be present for the relay to operate.

### Q : What are the advantages of using an SSR over a mechanical relay?

A: There are many applications that require a moderate amount of power (W to kW) to be switched on and off fairly rapidly. A good example would be the operation of a heater element in a controlled-temperature system. Typically, the amount of heat put into the system is regulated using pulse-width modulation turning a fixed-power heating element on and off for time periods ranging from seconds to minutes. Mechanical relays have a finite cycle life, as their components tend to wear out over thousands to millions of cycles. SSRs do not have this problem; in the proper application, they could be operated almost infinitely.

### Q : What are the limitations of using an SSR?

A: SSRs have a few limitations when compared to the capabilities of their mechanical counterparts. First, because the relay is semiconductor-based, it will never turn all the way on, nor off. This means that in the “on” state, the relay still has some internal resistance to the flow of electricity, causing it to get hot. When in the “off” state, the relay will exhibit a small amount of leakage current, typically a few mA. This leakage can conspire to keep some loads, especially ones with a high impedance, from turning off! Additionally, SSRs are more sensitive to voltage transients; while Opto 22 relays are very well transient-protected, if a relay gets hit hard enough a sufficient number of times, it will die or degrade. This makes SSRs less ideal for driving highly inductive electromechanical loads, such as some solenoids or motors. SSRs should also never be used for applications such as safety power disconnects, because even in the off state, leakage current is present. Leakage current through an SSR also implies the presence of a potentially high voltage. Even though the relay is not conducting a large amount of current, the switched terminal will still be “hot,” and thus dangerous.



**Q: Which SSRs should I use with a printed circuit board (PCB)?**

A: If you are mounting SSRs to a PCB, use the MP or P series SSRs which are designed for that purpose.

We do not recommend mounting the terminal side of a Power Series or Z series SSR to a flat PCB (or to any other flat surface), because there may be some variation in terminal height or alignment from one terminal to another and from one SSR to another.

**Q: Do you make multi-pole or multi-throw SSRs?**

A: Opto 22 manufactures only single-pole, single-throw SSRs. If multi-phase operation is required, just use a relay on each phase. Because of the limitations on semiconductor devices of the type used in SSRs, it is not practical to build single-device multi-throw SSRs. However, an alternative to multi-throw operation may be accomplished with multiple relays.

**Q: Can I hook up SSRs in parallel to achieve a higher current rating?**

A: No. There is no way to guarantee that two or more relays will turn on simultaneously when operated in parallel. Each relay requires a minimum voltage across the output terminals to function; because of the optical isolation feature, the “contact” part of the SSR is actually powered by the line it switches. One relay turning on before the other will cause the second relay to lose its turn-on voltage, and it won't ever turn on, or at least not until the first relay fails from carrying too much current.

**Q: What does a “zero-crossing” turn-on circuit refer to?**

A: An AC sine wave will be positive for the first half of each cycle and negative for the second half of each cycle. The voltage will cross through zero when the sine wave changes from the positive half-cycle to the negative half-cycle, and vice versa. So the voltage crosses through zero twice with each full AC sine wave cycle. “Zero-crossing” turn-on means that the SSR will only turn on when the AC sine wave passes through zero voltage. The actual turn-on will occur at or near zero voltage. All Opto 22 AC output solid-state relays are designed with a zero-crossing turn-on circuit. Zero-voltage turn-on has the benefit of minimizing electrical noise. All Opto 22 AC output solid-state relays use a zero-current turn-off circuit as well.

**Q: Can I use an AC SSR to switch DC?**

A: No. Because of the zero-crossing circuit described above, the relay will most likely never turn on, and even if it is on, it will most likely not be able to be turned off.

**Q: Can I use a DC SSR to switch AC?**

A: No. The semiconductor device used in Opto 22's DC SSRs is polarized. It may break down and conduct for the portion of the waveform that is reversed in polarity.

**Q: Can a DC SSR be used to switch an analog signal?**

A: This is not recommended at all. First, the voltage drop across the relay will cause signal loss. Second, the conduction characteristics of the SSR are very non-linear at low operating voltages and currents. Use a mechanical relay; it will work much better.

**Q: What agency approvals do your SSRs carry?**

A: In general, Opto 22 relays carry UL, CSA, CE and UKCA approval. See <http://support.opto22.com>. Additionally, some SSRs contain VDE-approved optocouplers; contact Opto 22 for more information.

## FAQ: SSR TROUBLESHOOTING

**Q: My SSR does not function anymore. What may have happened?**

A: There is no “normal” mode of failure for SSRs. They just stop working, by refusing to turn on or off. An improper installation is often to blame for an SSR failure, as these are very simple, reliable devices. If you have a failed SSR, it is important to look at the normal operating parameters of that relay within the larger system to make sure that the relay being used is appropriate to the application, and that the relay is being properly installed in the system. The three most common causes of SSR failure are as follows:

- **SSR improperly matched to load.** The relay was destroyed by overheating from carrying too much current too long.
- **SSR insufficiently protected.** Remember, a semiconductor is less tough than a simple metal contact. Reverse voltages exceeding the PRV rating of the relay will cause damage. Voltage spikes on the switched line, perhaps from inductive kickback, may have destroyed one or more of the internal switching devices. Remember to use snubbers, transorbs, MOVs, and/or commutating diodes on highly inductive loads.
- **SSR improperly installed.** The SSR was not mounted to a large enough heat sink, or no thermal compound was used, causing the relay to overheat. Also, insufficient tightening of the load terminals can cause arcing and ohmic heating of the relay. Opto 22 recommends 18 inch-pounds of torque on the load screw terminals. Similar failures have also been attributed to the use of crimp-on terminal lugs or spades; make sure such terminals are tightly crimped, and even drip some solder into the joint to ensure good electrical contact and protection from corrosion.

**Q: How can I test my SSR?**

A: It is not possible to test an SSR by the same methods used to test mechanical relays; a typical SSR will always show an infinite impedance to a resistance meter placed across the output terminals. There are a few reasons for this. First, the SSR requires a small amount of power to operate, derived from whatever voltage source is placed

on the load terminals. A typical multimeter will not supply sufficient voltage to cause the relay to change state. Second, AC SSRs contain zero-voltage turn-on and zero-current turn-off circuits. The SSR will not be able to turn on unless there is AC voltage connected to the output terminals. Most test equipment will supply a DC voltage to the relay, so it will never see the zero-voltage transition it requires to turn on. To test an SSR, it is best to operate it at the actual line voltage it will be used at, driving a load such as a large light bulb.

**Q : I have an SSR driving a load. The load turns on okay, but never seems to turn off, unless I remove power from the relay entirely. What might be happening?**

A: This is normally a problem when using an SSR with a high-impedance load, such as a neon lamp or a small solenoid. Loads like these often have relatively large initial currents, but relatively small "hold in" currents. The result is that the off-state leakage current through the relay (see previous section) is insufficient to cause the load to turn on to start with, but sufficient to keep it on, once started. The solution is to place a power resistor, sized for 8–10 times the rated maximum leakage current for the SSR in parallel with the load. Make sure that this resistor has a high enough power rating for the application. For example, for a 5 mA leakage current at 120 VAC, a resistor drawing 50 mA would be desirable. Using Ohm's Law, the resistor value becomes 2,400 ohms. This resistor will dissipate 6 watts, so a 7.5 or 10-watt size power resistor should be used.

**Q : I have a new AC SSR driving a solenoid. It turns on okay once, but will not turn on again. What is going on?**

A: Some solenoids, some types of halogen lights, and some types of strobe lights incorporate a diode in series with the coil or filament. This causes the light to behave as a half-wave rectifier. Opto 22 SSRs have a built-in R-C snubber circuit in parallel with the output. The capacitor in this circuit charges up but cannot discharge through the series diode, causing a voltage to appear across the SSR terminals. Because the SSR must detect the AC waveform cross through zero volts on the load terminals, it will not be able to turn on again. The solution here would be to put a high-value resistor (several tens of Kohms) across the terminals of the relay, to allow the capacitor to drain its charge.

## PRODUCTS

Opto 22 develops and manufactures reliable, easy-to-use, open standards-based hardware and software products. Industrial automation, process control, remote monitoring, data acquisition, and industrial internet of things (IIoT) applications worldwide all rely on Opto 22.

### groov RIO®

groov RIO edge I/O offers a single, compact, PoE-powered industrial package with web-based configuration and IIoT software built in, support for multiple OT and IT protocols, and security features like a device firewall, data encryption, and user account control.

Standing alone, groov RIO connects to sensors, equipment, and legacy systems, collecting and securely publishing data from field to cloud. Choose a universal I/O model with thousands of possible field I/O configurations, with or without Ignition from Inductive Automation®, or a RIO EMU energy monitoring unit that reports 64 energy data values from 3-phase loads up to 600 VAC, Delta or Wye.

You can even write an IEC 61131-3 compliant control program to run on groov RIO, using CODESYS. You can also use groov RIO with a Modbus/TCP master or as remote I/O for a groov EPIC system.

### groov EPIC® System

Opto 22's groov Edge Programmable Industrial Controller (EPIC) system gives you industrially hardened control with a flexible Linux®-based processor with gateway functions, guaranteed-for-life I/O, and software for your automation and IIoT applications.

### groov EPIC Processor

The heart of the system is the groov EPIC processor. It handles a wide range of digital, analog, and serial functions for data collection, remote monitoring, process control, and discrete and hybrid manufacturing.

In addition, the EPIC provides secure data communications among physical assets, control systems, software applications, and online services, both on premises and in the cloud. No industrial PC needed.

Configuring and troubleshooting I/O and networking is easier with the EPIC's integrated high-resolution color touchscreen. Authorized users can manage the system locally on the touchscreen, on a monitor connected via the HDMI or USB ports, or on a PC or mobile device with a web browser.

### groov EPIC I/O

groov I/O connects locally to sensors and equipment. Modules have a spring-clamp terminal strip, integrated wireway, swing-away cover, and LEDs indicating module health and discrete channel status. groov I/O is hot swappable, UL Hazardous Locations approved, and ATEX compliant.

### groov EPIC Software

The groov EPIC processor comes ready to run the software you need:

- Programming: Choose flowchart-based PAC Control, CODESYS Development System for IEC61131-3 compliant programs, or secure shell access (SSH) to the Linux OS for custom applications
- Node-RED for creating simple IIoT logic flows from pre-built nodes
- Efficient MQTT data communications with string or Sparkplug data formats
- Multiple OPC UA server options
- HMI: groov View to build your own HMI viewable on touchscreen, PCs, and mobile devices; PAC Display for a

Windows HMI; Node-RED dashboard UI

- Ignition or Ignition Edge® from Inductive Automation (requires license purchase) with OPC-UA drivers to Allen-Bradley®, Siemens®, and other control systems, and MQTT communications

### Older products

From solid state relays, to world-famous G4 and SNAP I/O, to SNAP PAC controllers, older Opto 22 products are still supported and working hard at thousands of installations worldwide. You can count on us for the reliability and service you expect, now and in the future.

## QUALITY

Founded in 1974, Opto 22 has established a worldwide reputation for high-quality products. All are made in the U.S.A. at our manufacturing facility in Temecula, California.

Because we test each product twice before it leaves our factory rather than testing a sample of each batch, we can afford to guarantee most solid-state relays and optically isolated I/O modules for life.

## FREE PRODUCT SUPPORT

Opto 22's California-based Product Support Group offers free technical support for Opto 22 products from engineers with decades of training and experience. Support is available in English and Spanish by phone or email, Monday–Friday, 7 a.m. to 5 p.m. PST.

Support is always available on our website, including [free online training](#) at OptoU, how-to [videos](#), [user's guides](#), the Opto 22 KnowledgeBase, and [OptoForums](#).

## PURCHASING OPTO 22 PRODUCTS

Opto 22 products are sold directly and through a worldwide network of distributors, partners, and system integrators. For more information, contact Opto 22 headquarters at **800-321-6786** (toll-free in the U.S. and Canada) or **+1-951-695-3000**, or visit our website at [www.opto22.com](http://www.opto22.com).

