

Style T - Top Entry

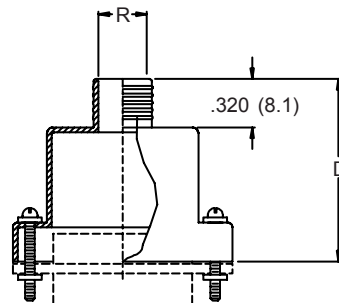

Style S - 90° Entry

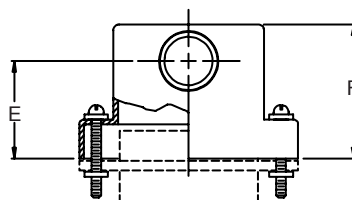

Style E - 45° Entry

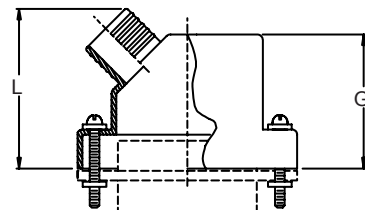

Connector shown for Reference Only

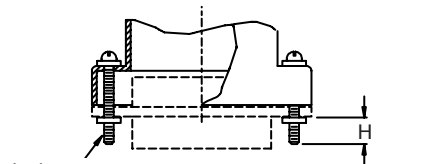

Jackscrew
Fillister Head
Symbol B

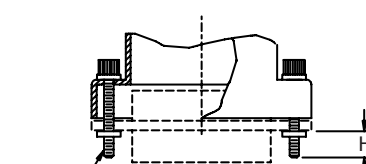
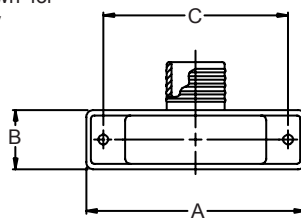

Jackscrew
Hex Socket
Symbol H

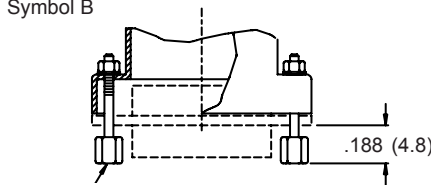

Female Jackpost
J Thread
Symbol F

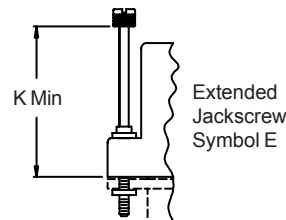

Extended
Jackscrew
Symbol E



Crimp Ring
Supplied on All Styles

Style T and S Only

NOTES:

1. Metric dimensions (mm) are indicated in parentheses.
2. Equivalent to Raytheon H5935-2218551.

507-190
EMI-RFII Crimp-Ring
Micro-D Backshell Assembly



MIL-DTL-83513
Micro-D

TABLE I: BACKSHELL AND CONNECTOR INTERFACE DIMENSIONS

Shell Size	A Max	B ±.005 (0.1)	C ±.005 (0.1)	D ±.020 (0.5)	E ±.0205 (0.5)	F ±.010 (0.3)	G ±.060 (1.5)	H Ref	J Thread
09	.785 (19.9)	.340 (8.6)	.565 (14.4)	.752 (19.1)	.460 (11.7)	.607 (15.4)	.650 (16.5)	.154 (3.9)	2-56 UNC-2A
15	.935 (23.7)	.340 (8.6)	.715 (18.2)	.802 (20.4)	.475 (12.1)	.643 (16.3)	.700 (17.8)	.154 (3.9)	2-56 UNC-2A
21	1.085 (27.6)	.340 (8.6)	.865 (22.0)	.852 (21.6)	.490 (12.4)	.677 (17.2)	.735 (18.7)	.154 (3.9)	2-56 UNC-2A
25	1.185 (30.1)	.360 (9.1)	.965 (24.5)	.902 (22.9)	.510 (13.0)	.718 (18.2)	.800 (20.3)	.154 (3.9)	2-56 UNC-2A
31	1.335 (33.9)	.360 (9.1)	1.115 (28.3)	.942 (23.9)	.518 (13.2)	.726 (18.4)	.860 (21.8)	.154 (3.9)	2-56 UNC-2A
37	1.485 (37.7)	.360 (9.1)	1.265 (32.1)	.982 (24.9)	.523 (13.3)	.744 (18.9)	.925 (23.5)	.154 (3.9)	2-56 UNC-2A
51	1.436 (36.5)	.400 (10.2)	1.215 (30.9)	1.062 (27.0)	.555 (14.1)	.829 (21.1)	.975 (24.8)	.154 (3.9)	2-56 UNC-2A
100	2.175 (55.2)	.450 (11.4)	1.800 (45.7)	1.127 (28.6)	.625 (15.9)	.984 (25.0)	1.050 (26.7)	.184 (4.7)	4-40 UNC-2A

TABLE I (CONTINUED):

Shell Size	K Min	L Max	M ±.005 (0.1)
09	.590 (15.0)	.875 (22.2)	.160 (4.1)
15	.720 (18.3)	.925 (23.5)	.190 (4.8)
21	.830 (21.1)	.975 (24.8)	.220 (5.6)
25	.890 (22.6)	1.025 (26.0)	.260 (6.6)
31	.950 (24.1)	1.065 (27.0)	.275 (7.0)
37	.990 (25.1)	1.105 (28.1)	.285 (7.2)
51	1.020 (25.9)	1.187 (30.1)	.350 (8.9)
100	1.080 (27.4)	1.250 (31.8)	.490 (12.4)

**TABLE II:
JACKSCREWS**

Symbol	Jackscrew Type
B	Fillister Head, Male (2)
H	Hex Socket, Male (2)
E	Extended, Male (2)
F	Jackpost, Female (2)
FB	Jackpost, Female (1)
	Fillister Head, Male (1)
FH	Jackpost, Female (1)
	Hex Socket, Male (1)

**TABLE III:
FINISH OPTIONS**

Symbol	Finish
B	Cadmium Plate/Olive Drab
C*	Black Anodize
G*	Anodic Hard Coat
J	Gold Iridite over Cadmium Plate over Electroless Nickel
LF	Cadmium Plate/Bright over Electroless Nickel
M	Electroless Nickel
N	Cadmium Plate/Olive Drab over Electroless Nickel
NC	Zinc Cobalt/Dark Olive Drab
NF	Cadmium Plate/Olive Drab over Electroless Nickel
T	Cadmium Plate/Bright over Electroless Nickel
U**	Cadmium Plate/Black
ZN	Zinc-Nickel Alloy/Olive Drab

*Anodize finish is not suitable for EMI shielding or grounding applications.

**Applicable to corrosion resisting steel backshells and accessories. Consult factory for other available finishes.

Metric dimensions (mm) are indicated in parentheses