

3.0A PMU For Lithium Battery

Description

The NDP4135DB integrates high-performance 2.4MHz DC-DC step-down converter, linear lithium battery charging, LED status indication, NTC detection, and other functions, serving as a complete solution for simulating alkaline batteries with lithium batteries.

The DC-DC automatically adjusts the output voltage based on the remaining charge of the lithium battery to simulate the discharge curve of an alkaline battery, with a maximum output current of 3.0A. The chip provides two charging modes: adapter port and output port, giving users flexible options. The NTC function detects the battery temperature in real-time to ensure the safety and reliability of the battery.

The NDP4135DB uses the DFN3*2 package, which is small and convenient, facilitating product design.

Features

- 10uA Standby Current
- Up to 3.0A Discharge Current
- Up to 90% Efficiency
- 2.4MHz Switching Frequency
- Simulate the Discharge Curve of the Alkaline Battery
- Detect Battery Temperature in Real-time
- Two Linear Charging Modes
- Three Stage Charging: Trickle Current, Constant Current, and Constant Voltage Charging
- Under Voltage Lock Out Protection
- Over-Current / Short-Circuit Protection
- Over Temperature Protection
- Available in DFN3*2-8L Package

Applications

- Lithium Battery

Typical Application

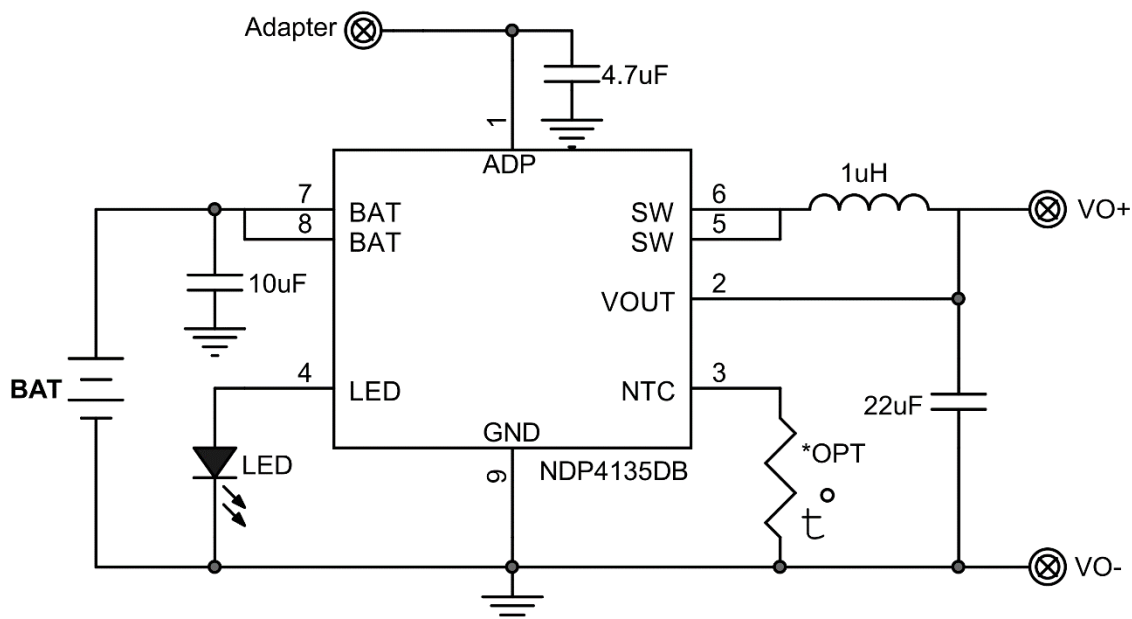

Order Information

Orderable Device	Package Type	Packing Qty/reel	MSL- Peak Temp -Floor Life	Eco Std	Marking Information
NDP4135DB	DFN3*2-8L	3000	MSL3-260°C-168hrs	RoHS & Green	Refer to below

Product Naming

NDP4135 DB - XX

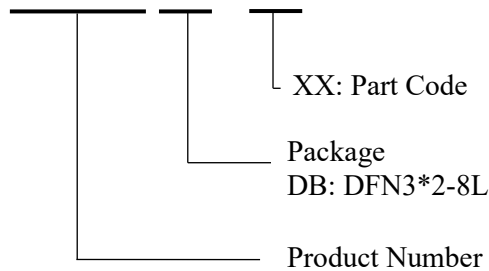

Top Side Marking



Y: Year (23=2023,24=2024,...)
 WW: Weekly (01-53)
 F/N: Internal ID Code
 XX: Part Code

Part Code	Description
NDP4135DB-B4	V _{BAT} =4.20V, I _{CHARG} =450mA
NDP4135DB-E4	V _{BAT} =4.35V, I _{CHARG} =450mA
NDP4135DB-B7	V _{BAT} =4.20V, I _{CHARG} =700mA
NDP4135DB-E7	V _{BAT} =4.35V, I _{CHARG} =700mA

Notes:

- RoHS:** Quoted from **RoHS Detective (EU) 2015/863**, Deep-Pool defines "RoHS" to mean semiconductor products that are compliant with the current EU RoHS requirements. Where designed to be soldered at high temperatures, "RoHS" products are suitable for use in specified lead-free processes. Deep-Pool may reference these types of products as "**Pb-Free**".
- RoHS Exempt:** Deep-Pool defines "RoHS Exempt" to mean products that contain lead but are compliant with EU RoHS pursuant to a specific EU RoHS exemption.
- Green:** Deep-Pool defines "Green" to mean the content of Chlorine (Cl) and Bromine (Br) based flame retardants meet JEDEC (**JS709C**) low halogen requirements of <=1000ppm threshold.
- MSL, Peak Temp. -** The Moisture Sensitivity Level rating according to the JEDEC (**J-STD-020F**) industry standard classifications, as well as the peak solder temperature of SMT and the floor life after unpacking, which customers should pay attention and strictly comply with the standard to use.
- There may be additional marking, which relates to the logo, the lot trace code information, or the environmental category on the device.

The information provided on this page represents **Deep-Pool's** knowledge and belief as of the date that it is provided. **Deep-Pool** bases its knowledge and belief on information provided by third parties and makes no representation or warranty as to the accuracy of such information. Efforts are underway to better integrate information from third parties. **Deep-Pool** has taken and continues to take reasonable steps to provide

representative and accurate information but may not have conducted destructive testing or chemical analysis on incoming materials and chemicals. **Deep-Pool** and **Deep-Pool** suppliers consider certain information to be proprietary, and thus CAS numbers and other limited information may not be available for release.

Pin Function and Definition

Pin	Name	Definition
1	ADP	Charging Power Input Pin
2	VOUT	Output Voltage Feedback Pin
3	NTC	Battery Temperature Detection pin, Connect NTC Resistor to GND
4	LED	Charging Status Indicator Pin, Connected to LED
5,6	SW	Switch Pin
7,8	BAT	Battery Pin, Connected to Lithium Battery
9	GND	Ground

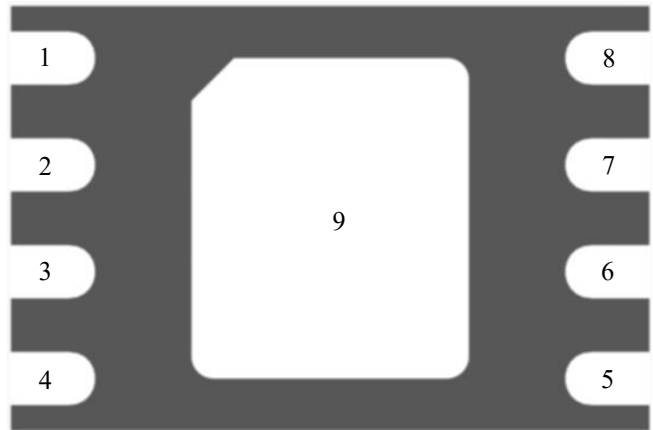

Absolute Maximum Ratings (at T_A= 25°C)

Characteristics	Symbol	Rating	Unit
ADP, SW, BAT to GND		-0.3 to 7	V
VOUT to GND		-0.3 to 7	V
LED, NTC to GND		-0.3 to 5.5	V
Operating Junction Temperature	T _A		°C
Storage Junction Temperature	T _{stg}	-65 to 150	°C
Thermal Resistance from Junction to case	θ _{JC}	45	°C/W

Notes:

Stresses at or above those listed under Absolute Maximum Ratings may cause permanent damage to the product. This is a stress rating only; functional operation of the product at these or any other conditions above those indicated in the operational section of this specification is not implied. Operation beyond the maximum operating conditions for extended periods may affect product reliability.



Electrical Characteristics

$T_J = 25^{\circ}\text{C}$, $V_{IN} = 12\text{V}$, unless otherwise noted.

Characteristics	Symbol	Conditions	Min	Typ	Max	Units
Charging Performance						
ADP Input Voltage	V_{ADP}		4.6		5.5	V
ADP UVLO	V_{ADP_UVLO}			4.6		V
Charge Current	I_{CHG}	Part Code: B4/E4		450		mA
		Part Code: B7/E7		700		mA
VBAT Accuracy in Constant Voltage Charge Mode	V_{BAT}		-1%		1%	V
Trickle Charge Threshold Voltage	V_{TRIKL}			2.9		V
Trickle Charge Current	I_{TRIKL}	Percent of I_{CHG}		10		%
VOUT Input Voltage for Charging BAT	V_{OUT}	V_{OUT} used for charge battery	3.2		5.5	V
LED Driving Current	I_{LED}			1.5		mA
LED Blink Frequency	F_{LED}	Charging		1.2		Hz
Discharging Performance						
BAT Input Current	I_{CC_BAT}	VO+ NO Load		10		uA
BAT UVLO OFF		BAT Decreasing	2.7	2.8	3.0	V
BAT UVLO ON		BAT Rising				
Output Voltage	V_{OUT}		1.47	1.5	1.53	V
Max Output Current	I_{OUT}			3		A
Low Battery Output Voltage	V_{OUT_L}	$V_{BAT} = BAT_{UVLO}$		1.05		V
Frequency	F_{SW}		2.2	2.4		MHz
Output Voltage Regulation	V_{BAT_REG}	BAT Decreasing		3.3		V
NTC Current Source	I_{NTC}	NTC=0V		12.5		uA
NTC Protect Threshold	V_{OTP_NTC}			0.225		V
Internal MOSFET on Resistance	R_{DSON_UP}			60		m Ω
Internal MOSFET on Resistance	R_{DSON_DOWN}			30		m Ω
Hiccups Interval	T_{HICCUP}			500		mS
Internal over Temperature Protect	OTP			140		$^{\circ}\text{C}$
OTP Hysteresis				10		$^{\circ}\text{C}$

Typical Performance Characteristics

T_J = 25°C , V_{IN} = 12V , unless otherwise noted.

Power ON

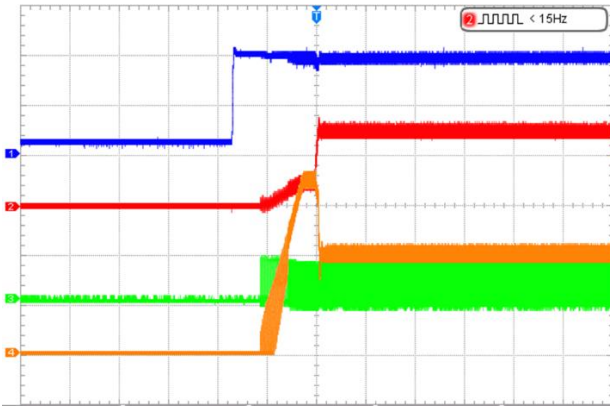

CH1=VBAT,CH2=Vout,CH3=SW,CH4=ISW
CH1=2V/div,CH2=1V/div,CH3=5V/div,CH4=1A/div

Power OFF

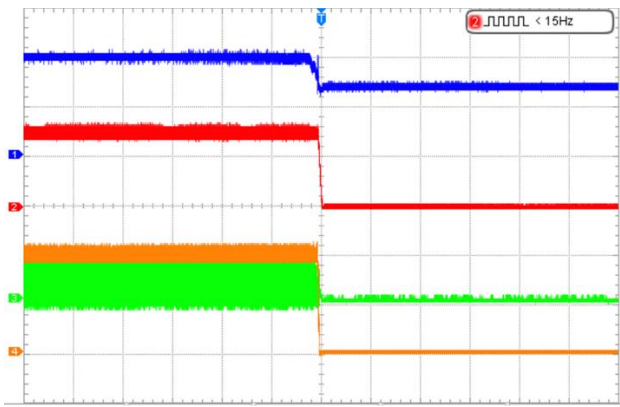

CH1=VBAT,CH2=Vout,CH3=SW,CH4=ISW
CH1=2V/div,CH2=1V/div,CH3=5V/div,CH4=1A/div

I_{OUT}=0.1A

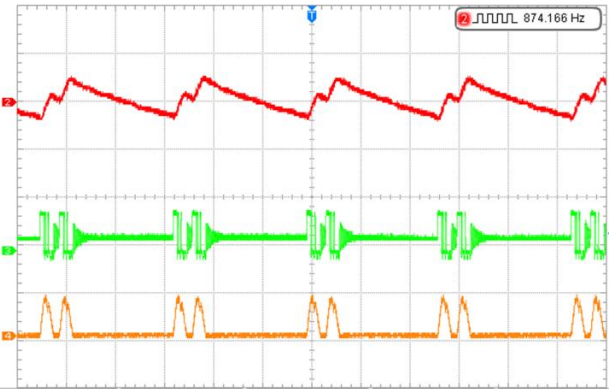

CH2=Vout,CH3=SW,CH4=ISW
CH2=1V/div,CH3=5V/div,CH4=1A/div

I_{OUT}=2.5A

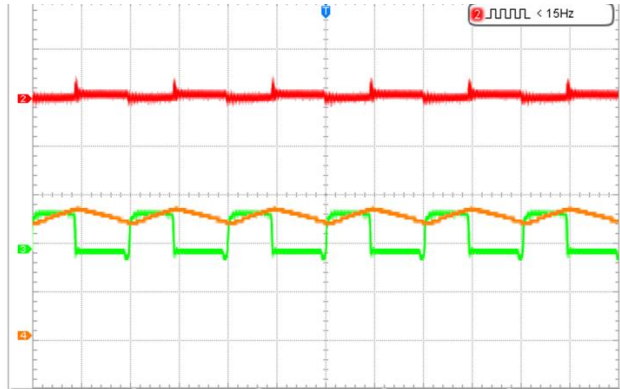

CH2=Vout,CH3=SW,CH4=ISW
CH2=2V/div,CH2=1V/div,CH3=5V/div,CH4=1A/div

Line Regulation

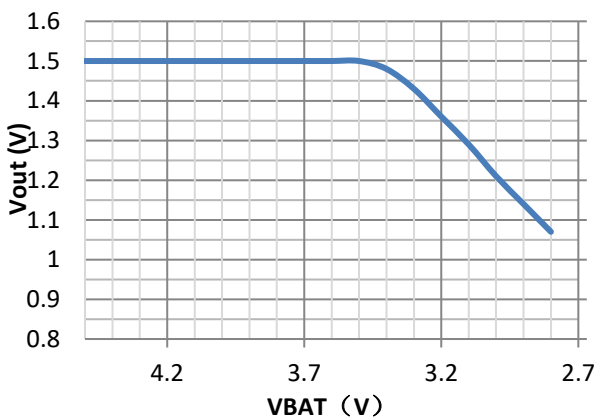

Load Regulation

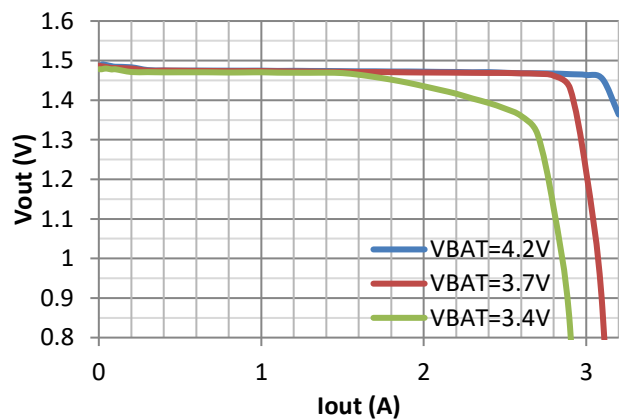

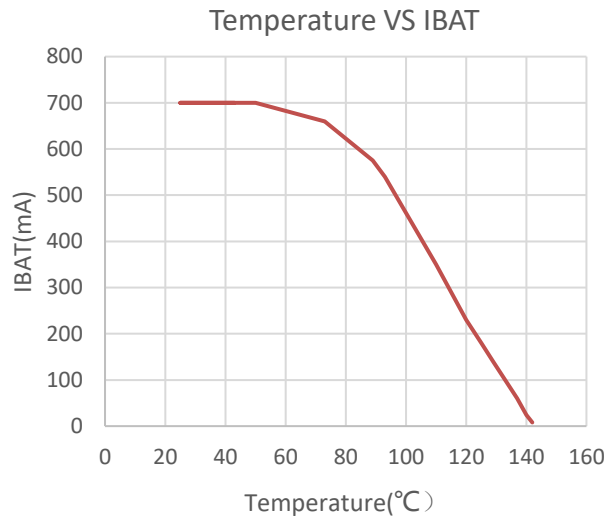
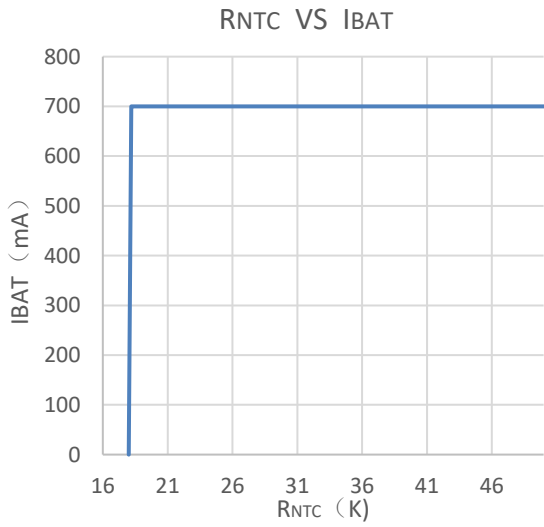
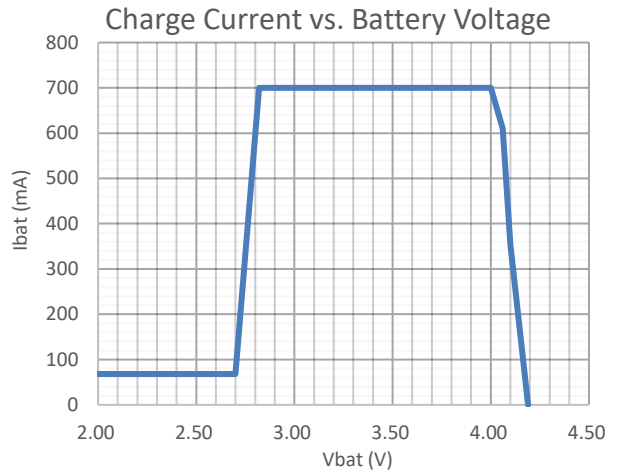
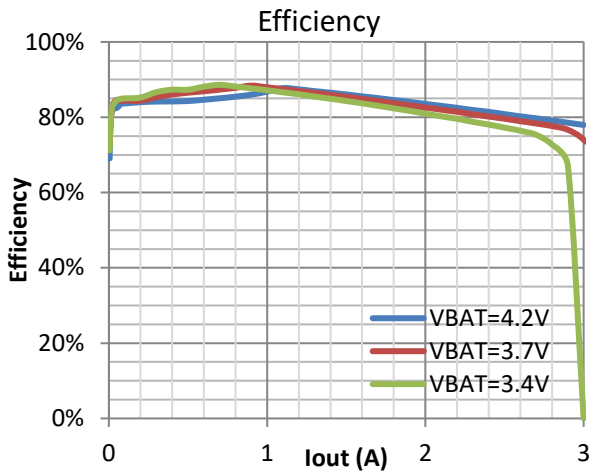

Block Diagram

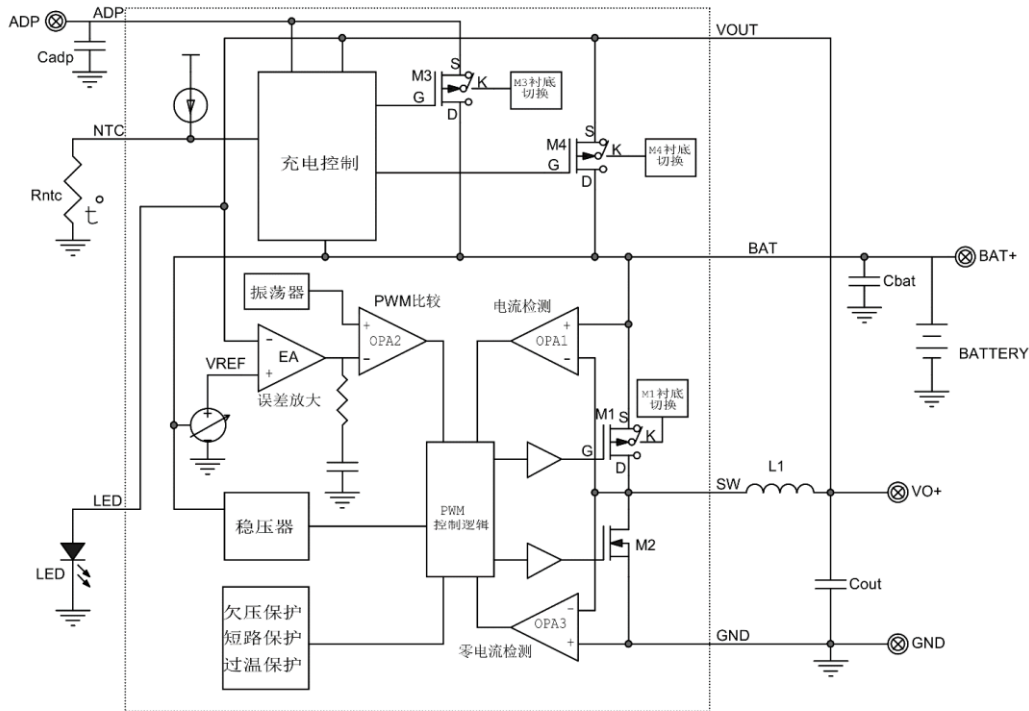

Operational Description

NDP4135DB is a lithium battery power management chip designed for simulating the output of alkaline batteries, internally integrating two linear charging modes for lithium batteries: adapter port and output port, as well as a low-power Buck DC-DC circuit. Flexible selection of two linear charging modes for user-friendly design and maximize use the battery capacity. The DC-DC output voltage mimics the discharge curve of alkaline batteries, and the no-load power consumption is only 10uA, extending the battery life as much as possible. It also features a maximum discharge current of 3.0A.

Linear Charging

NDP4135DB features two linear charging modes: ADP port and VOUT port. When the voltage of ADP or VOUT port is greater than 4.6V, it automatically charges the lithium battery connected to the BAT port. If the voltages of both ADP and VOUT ports are greater than 4.6V, the chip internally

prefers charging through the ADP port. If the ADP function is not used, the pin can be left unconnected or an external 1uF decoupling capacitor can be connected.

BAT terminal adopts a standard three-stage charging mode, including trickle, constant current, and constant voltage charging. When the battery voltage is lower than 2.9V, it automatically enters the trickle charging stage with a current of 10% of the constant current charging. It also supports 0V battery charging. When the battery voltage is greater than 2.9V but less than the full charge voltage, it enters the constant current charging stage, and the charging current value can be referred to the purchase information. When the battery voltage is close to the full charge voltage, the chip automatically switches to the constant voltage charging mode, and the charging current decreases until the battery is fully charged. The full charge voltage value can be referred to the purchase information.

LED Indication

The LED indicates the battery charging status. During charging, the LED flashes at a frequency of 1.2Hz. After the battery is fully charged, the LED remains on constantly. During discharging, the LED remains off and does not light up.

NTC Protection

The NTC pin is externally connected to a thermistor resistor to monitor the battery temperature during charging. An internal constant current source generates a voltage drop on the thermistor resistor as the battery temperature rises. When the battery temperature increases and the NTC resistance drops to around 18K (i.e., when the voltage at the NTC pin drops to less than 0.225V), it automatically cuts off the charging function to prevent further charging that could damage the battery in abnormal situations. If during discharging, the battery temperature rises too high and the NTC resistance drops to around 18K (i.e., when the voltage at the NTC pin drops to less than 0.225V), it automatically cuts off the discharging function.

DC-DC Discharging

NDP4135DB internally integrates a low-power and high-efficiency BUCK circuit that consumes only

10uA current when idle to maximize battery usage time. With a 2.4MHz switching frequency, it provides a maximum peak current output of 3.0A to meet various application environments as much as possible. The DC-DC output current also decreases as the battery voltage decreases. The output voltage completely mimics the discharge curve of alkaline cells. When the battery voltage is greater than 3.3V, the VOUT output is fixed at 1.5V. When the battery voltage is lower than 3.3V, the VOUT voltage decreases linearly with the decrease of battery voltage to notify electrical devices that the battery is in low power condition.

Protection function

NDP4135DB internally integrates comprehensive overcurrent and overtemperature protection functions. During linear charging, if the chip temperature rises too high, it automatically reduces the charging current to prevent overtemperature hazards. After output discharge overcurrent or short circuit, DC-DC enters a hiccup restart state with a hiccup interval of 500mS.

Package Outline Drawing

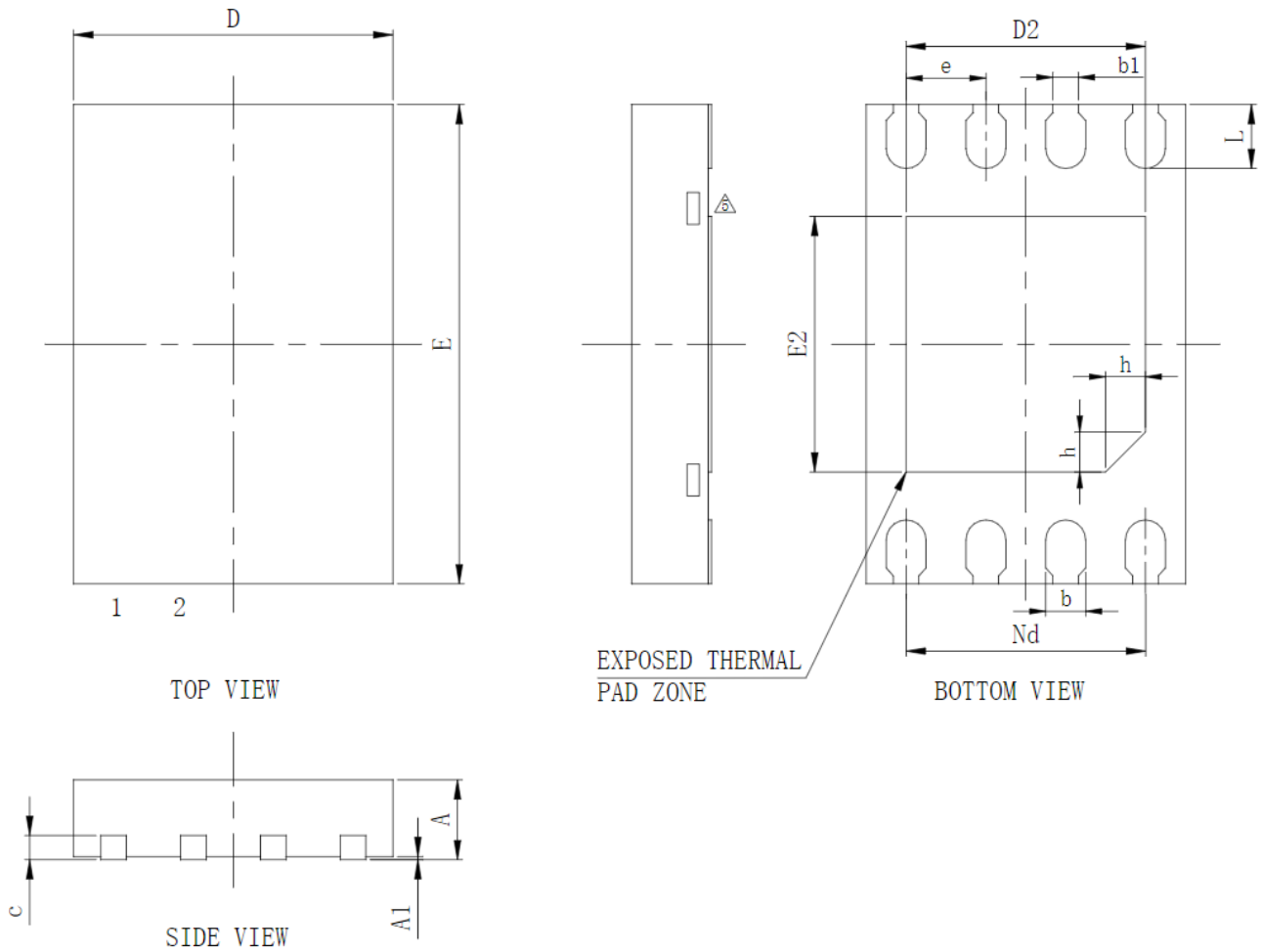

Symbol	Dimensions In Millimeters		
	Min	Normal	Max
A	0.50	0.55	0.60
A1	0.00	0.02	0.05
b	0.18	0.25	0.30
b1	0.16 REF		
c	0.10	0.15	0.20
D	1.90	2.00	2.10
D2	1.40	1.50	1.60
e	0.50 BCS		
Nd	1.50 BCS		
E	2.90	3.00	3.10
E2	1.50	1.60	1.70
L	0.30	0.40	0.50
h	0.20	0.25	0.30

Notes

1. Use millimeters as the primary measurement
2. Dimensioning and tolerances conform to ASME Y14.5M. – 1994
3. These dimensions do not include mold flash or protrusions.
4. Mold flash or protrusions shall not exceed 0.15mm

Disclaimer

ALL PRODUCT, PRODUCT SPECIFICATIONS AND DATA ARE SUBJECT TO CHANGE WITHOUT NOTICE TO IMPROVE RELIABILITY, FUNCTION OR DESIGN OR OTHERWISE.

Jiangsu Deep-Pool Microelectronics Co., Ltd, and its affiliates, agents, employees, as well as all persons acting on its or their behalf (collectively, “**Deep-Pool**”), disclaim any and all liability for any errors, inaccuracies or incompleteness contained in any datasheet or in any other disclosure relating to any product.

Deep-Pool makes no warranty, representation or guarantee regarding the suitability of the products for any particular purpose or the continuing production of any product. To the maximum extent permitted by applicable law, Deep-Pool disclaims (a) any and all liability arising out of the application or use of any product, (b) any and all liability, including without limitation special, consequential or incidental damages, and (c) any and all implied warranties, including warranties of fitness for particular purpose, non-infringement and merchantability.

Statements regarding on the suitability of products for certain types of applications are based on Deep-Pool's knowledge of typical requirements that are often placed on Deep-Pool products in generic applications. Such statements are not binding statements about the suitability of products for a particular application. It is the customer's responsibility to validate that a particular product with the properties described in the product specification is suitable for use in a particular application. Parameters provided in datasheets or specifications may vary in different applications and performance may vary over time. All operating parameters, including typical parameters, must be validated for each customer application by the customer's technical experts. Product specifications should not be expanded or otherwise modify Deep-Pool's terms and conditions of purchase, including but not limited to the warranty announced therein.

Unless expressly stated in writing, Deep-Pool products are not designed for use in medical, life-saving, or life-sustaining applications or for any other application in which the failure of product could result in personal injury or death. Customers who use or sell Deep-Pool products not expressly indicated for use in such applications do so at their own risk. Please contact authorized Deep-Pool personnel to obtain written terms and conditions regarding products designed for such applications.