

TRANSIENT VOLTAGE SUPPRESSOR

Features

- ◆ For surface mounted applications in order to optimize board space.
- ◆ Low profile package
- ◆ Glass passivated junction
- ◆ Low inductance
- ◆ Plastic package has Underwriters Laboratory Flammability

Mechanical Data

Case: JEDEC UOD-123FL molded plastic body
 Terminals: Solderable per MIL-STD-750, Method 2026A
 Polarity: Polarity symbol marking on body
 Mounting Position: Any
 Weight: 0.0048 ounce, 0.015grams
 Marking: Date Code and Marking Code See Page 2

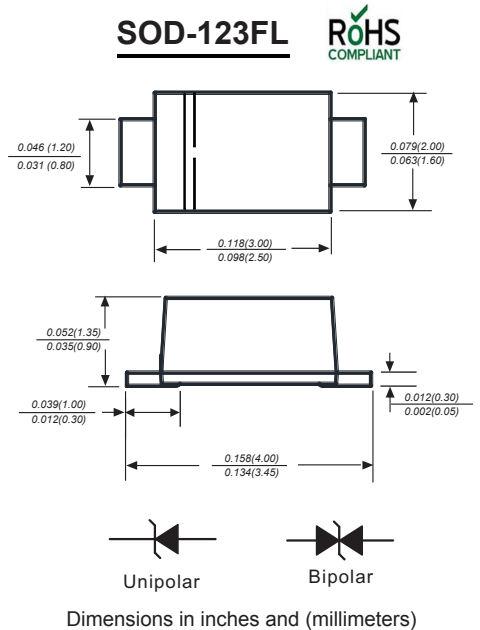

Maximum Ratings and Electrical characteristics

Ratings at 25 °C ambient temperature unless otherwise specified.

Parameter	Symbol	Value	Unit
Peak Pulse Power Dissipation on TA=25°C (Note 1,2,5, Fig1)	P_{PPM}	200	W
Peak Forward Surge Current (Note 3)	I_{FSM} (UNI)	20	A
Peak Pulse Current on 10/1000 us waveform (Note 1) Fig 2	I_{PPM}	see Table 1	A
Steady State Power Dissipation (Note 4)	$P_{M(AV)}$	1.0	W
Operating Junction and Storage Range	T_J, T_{STG}	-55 to +150	°C
Typical Thermal Resistance	$R_{\theta JA}$	180	°C/W

NOTES

1. Non-repetitive current pulse per Fig 3 and derated above $T_a=25^\circ\text{C}$ per Fig 2
2. Mounted on 5mm² copper pads to each terminal
3. 8.3ms single half sinewave, or equivalent square wave duty cycle=4 pulses per minutes maximum
4. lead temperature at $T_l=75^\circ\text{C}$
5. Peak pulse powe. waveform is $t_p=10/1000\mu\text{s}$
6. A transient suppressor is selected according to the working peak reverse voltage(V_{RWM}), Which Should be equal to or greater than the DC or continuous peak operating voltage level



SMF5.0(C)A THRU SMF440(C)A

Stand-off Voltage - 5.0 to 440 Volts Peak Pulse Power: 200 Watts

Characteristics at Ta = 25°C

Table 1

Type		Marking		V _{RWM}	Breakdown Voltage		Test Current	Reverse Leakage	Max. Clamp Voltage	Peak Pulse Current
					V _{BR} @ I _T					
					Min	Max	I _T	I _R @ V _{RWM}	V _C @ I _{PP}	I _{PP}
Uni	Bi	Uni	Bi	V	V	V	mA	µA	V	A
SMF5.0A	SMF5.0CA	5.0A	5.0CA	5	6.4	7	10	400	9.2	21.7
SMF6.0A	SMF6.0CA	6.0A	6.0CA	6	6.67	7.37	10	400	10.3	19.4
SMF6.5A	SMF6.5CA	6.5A	6.5CA	6.5	7.22	7.98	10	250	11.2	17.9
SMF7.0A	SMF7.0CA	7.0A	7.0CA	7	7.78	8.6	10	100	12	16.7
SMF7.5A	SMF7.5CA	7.5A	7.5CA	7.5	8.33	9.21	1	50	12.9	15.5
SMF8.0A	SMF8.0CA	8.0A	8.0CA	8	8.89	9.83	1	25	13.6	14.7
SMF8.5A	SMF8.5CA	8.5A	8.5CA	8.5	9.44	10.4	1	10	14.4	13.9
SMF9.0A	SMF9.0CA	9.0A	9.0CA	9	10	11.1	1	5	15.4	13
SMF10A	SMF10CA	10A	10CA	10	11.1	12.3	1	2.5	17	11.8
SMF11A	SMF11CA	11A	11CA	11	12.2	13.5	1	2.5	18.2	11
SMF12A	SMF12CA	12A	12CA	12	13.3	14.7	1	2.5	19.9	10.1
SMF13A	SMF13CA	13A	13CA	13	14.4	15.9	1	1	21.5	9.3
SMF14A	SMF14CA	14A	14CA	14	15.6	17.2	1	1	23.2	8.6
SMF15A	SMF15CA	15A	15CA	15	16.7	18.5	1	1	24.4	8.2
SMF16A	SMF16CA	16A	16CA	16	17.8	19.7	1	1	26	7.7
SMF17A	SMF17CA	17A	17CA	17	18.9	20.9	1	1	27.6	7.2
SMF18A	SMF18CA	18A	18CA	18	20	22.1	1	1	29.2	6.8
SMF20A	SMF20CA	20A	20CA	20	22.2	24.5	1	1	32.4	6.2
SMF22A	SMF22CA	22A	22CA	22	24.4	26.9	1	1	35.5	5.6
SMF24A	SMF24CA	24A	24CA	24	26.7	29.5	1	1	38.9	5.1
SMF26A	SMF26CA	26A	26CA	26	28.9	31.9	1	1	42.1	4.8
SMF28A	SMF28CA	28A	28CA	28	31.1	34.4	1	1	45.4	4.4
SMF30A	SMF30CA	30A	30CA	30	33.3	36.8	1	1	48.4	4.1
SMF33A	SMF33CA	33A	33CA	33	36.7	40.6	1	1	53.3	3.8
SMF36A	SMF36CA	36A	36CA	36	40	44.2	1	1	58.1	3.4
SMF40A	SMF40CA	40A	40CA	40	44.4	49.1	1	1	64.5	3.1
SMF43A	SMF43CA	43A	43CA	43	47.8	52.8	1	1	69.4	2.9
SMF45A	SMF45CA	45A	45CA	45	50	55.3	1	1	72.7	2.8
SMF48A	SMF48CA	48A	48CA	48	53.3	58.9	1	1	77.4	2.6
SMF51A	SMF51CA	51A	51CA	51	56.7	62.7	1	1	82.4	2.4
SMF54A	SMF54CA	54A	54CA	54	60	66.3	1	1	87.1	2.3
SMF58A	SMF58CA	58A	58CA	58	64.4	71.2	1	1	93.6	2.1
SMF60A	SMF60CA	60A	60CA	60	66.7	73.7	1	1	96.8	1.8
SMF64A	SMF64CA	64A	64CA	64	71.1	78.6	1	1	103	1.7
SMF70A	SMF70CA	70A	70CA	70	77.8	86	1	1	113	1.5
SMF75A	SMF75CA	75A	75CA	75	83.3	92.1	1	1	121	1.4
SMF78A	SMF78CA	78A	78CA	78	86.7	95.8	1	1	126	1.4
SMF85A	SMF85CA	85A	85CA	85	94.4	104	1	1	137	1.3
SMF90A	SMF90CA	90A	90CA	90	100	111	1	1	146	1.2
SMF100A	SMF100CA	100A	100CA	100	111	123	1	1	162	1.1
SMF110A	SMF110CA	110A	110CA	110	122	135	1	1	177	1
SMF120A	SMF120CA	120A	120CA	120	133	147	1	1	193	0.9
SMF130A	SMF130CA	130A	130CA	130	144	159	1	1	209	0.8
SMF150A	SMF150CA	150A	150CA	150	167	185	1	1	243	0.7
SMF160A	SMF160CA	160A	160CA	160	178	197	1	1	259	0.7
SMF170A	SMF170CA	170A	170CA	170	189	209	1	1	275	0.6
SMF180A	SMF180CA	180A	180CA	180	201	222	1	1	292	0.5
SMF190A	SMF190CA	190A	190CA	190	211	232	1	1	308	0.5
SMF200A	SMF200CA	200A	200CA	200	224	247	1	1	324	0.5
SMF220A	SMF220CA	220A	220CA	220	246	272	1	1	356	0.5
SMF250A	SMF250CA	250A	250CA	250	279	309	1	1	405	0.5
SMF300A	SMF300CA	300A	300CA	300	335	371	1	1	486	0.45
SMF350A	SMF350CA	350A	350CA	350	391	432	1	1	567	0.4
SMF400A	SMF400CA	400A	400CA	400	447	494	1	1	648	0.35
SMF440A	SMF440CA	440A	440CA	440	492	543	1	1	713	0.3

Typical Characteristics

Fig.1 Peak Pulse Power Rating Curve

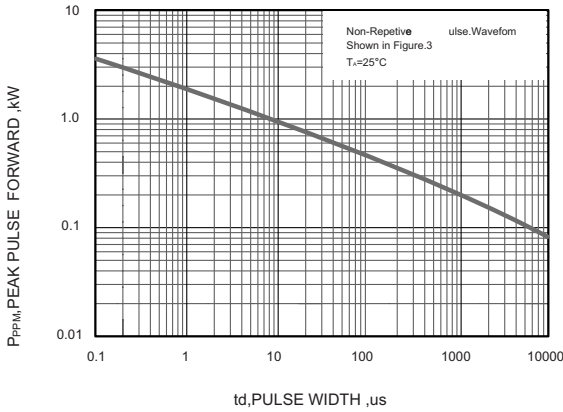

Fig.2 Forward Current Derating Curve

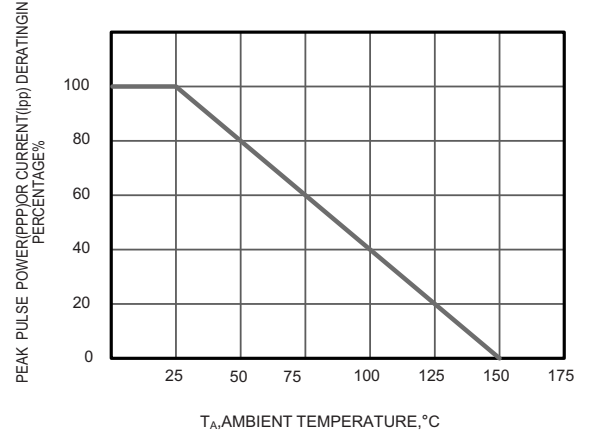

Fig.3 Pulse Waveform

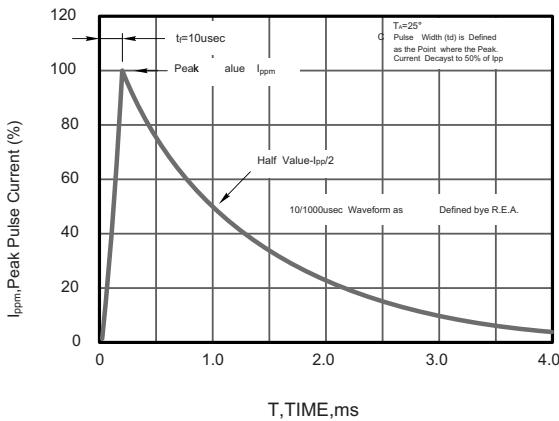
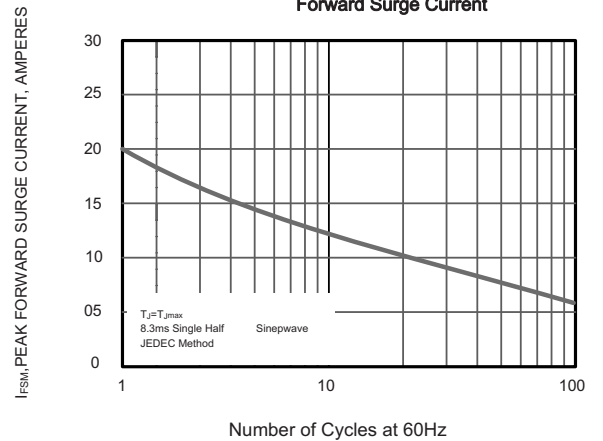
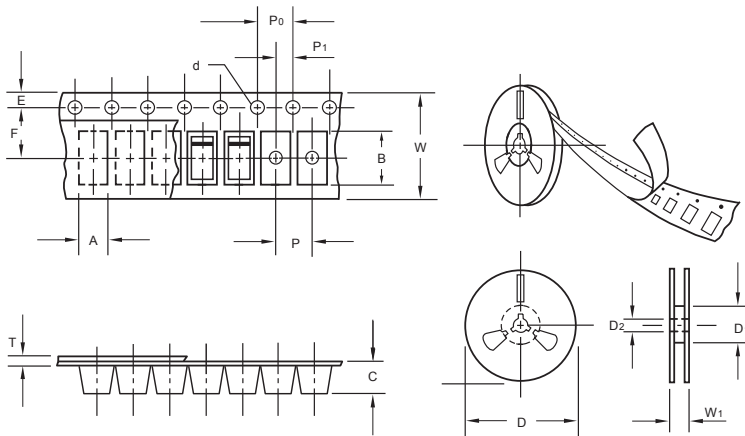

Fig.4 Maximum Non-Repetitive Peak Forward Surge Current



The curve above is for reference only.

Packing information



unit:mm

Item	Symbol	Tolerance	SOD-123FL
Carrier width	A	0.1	2.1
Carrier length	B	0.1	4.0
Carrier depth	C	0.1	1.60
Sprocket hole	d	0.05	1.55
7" Reel outside diameter	D	2.0	178.00
7" Reel inner diameter	D1	min	50.0
Feed hole diameter	D2	0.5	13.00
Sprocket hole position	E	0.1	1.75
Punch hole position	F	0.1	3.50
Punch hole pitch	P	0.1	4.00
Sprocket hole pitch	P0	0.1	4.00
Embossment center	P1	0.1	2.00
Overall tape thickness	T	0.1	0.25
Tape width	W	0.3	8.15
Reel width	W1	1.0	10.5

Note: Devices are packed in accordance with EIA standard RS-481-A and specifications listed above.

Reel packing

PACKAGE	REEL SIZE	REEL (pcs)	COMPONENT SPACING (m/m)	BOX (pcs)	INNER BOX (m/m)	REEL DIA, (m/m)	CARTON SIZE (m/m)	CARTON (pcs)	APPROX. GROSS WEIGHT (kg)
SOD-123FL	7"	3,000	4.0	45,000	210*208*203	178	430*430*235	180,000	9.0

Suggested Pad Layout

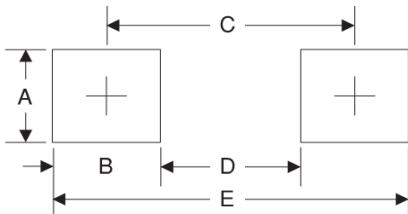

Symbol	Unit (mm)	Unit (inch)
A	1.2	0.047
B	1.2	0.047
C	3.2	0.126
D	2	0.079
E	4.4	0.173