

1. 产品尺寸图Product Dimension Drawing

标识点
Identification points

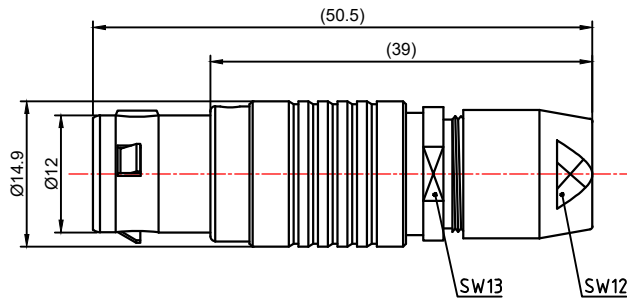

焊接顺序点
Weld sequence points

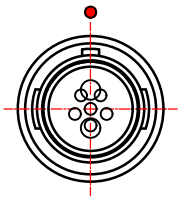
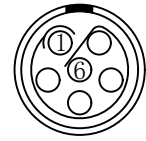

2. 产品电器参数Product electrical parameters

防护等级 (Ingress protection) IP50(头座插合时When the headstand is plugged in)

插拔测试 (Plugging and unplugging test) <5000次

产品耐温 (The product is temperature resistant) -55° C / +150° C

盐雾腐蚀 (Salt Spray Corrosion) >72 hr

测试电压 (kV rms) 针芯-针芯 1.35

测试电压 (kV rms) 针芯-外壳 1.45

额定电流Current rating 12A

导体接触规格 Conductor contact specifications 1.3

最大接触电阻 (mΩ)Maximum Contact Resistance (mΩ) 3.0

绝缘电阻 (Insulation resistance) 5000MΩ (常态)

屏蔽 (分钟) Shielding (min) 100 g (6 ms)

3. 环境及表面处理产品特性Environmental and surface treatment product characteristics

外壳材料 Housing material 金属件铜合金镀镍镀铬
(Metal parts: copper alloy nickel plated and chrome plated)

导体材料 Conductor material 铜合金镀金 (Copper alloy gold-plated)

绝缘体材料 Insulator material PPS (可选PEEK) PPS (optional PEEK)

4. 线缆参数Cable parameters

固定类型 Fixed type 电缆夹头 (Cable chucks)

护套电缆外径 (mm) 7.3-8.2mm
Sheath cable outer diameter (mm)

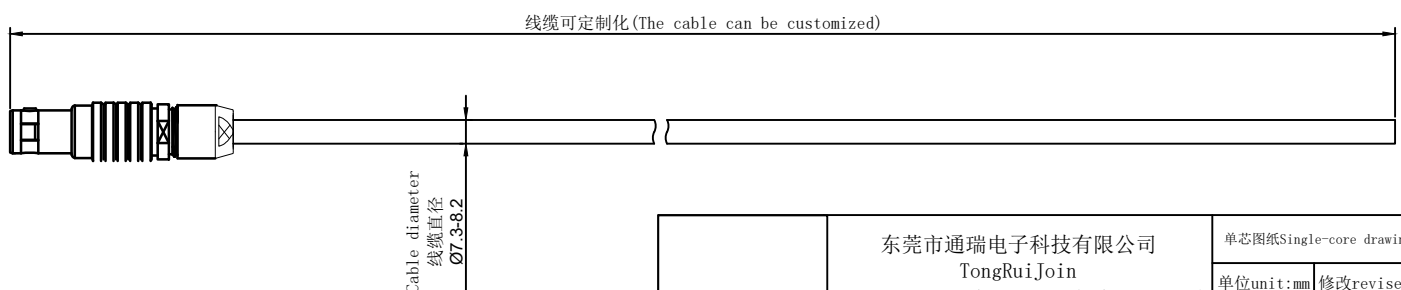

1: 连接器组装生产所有公差通常为0.1mm,2: 插座直接拧入螺纹孔中, 螺纹 +0.05mm
1: All tolerances are usually 0.1mm for connector assembly production, 2: The socket is screwed directly into the threaded hole, the thread is +0.05mm

	东莞市通瑞电子科技有限公司 TongRuiJoin Dongguan Tongrui Electronic Technology Co., Ltd www.Cltfre.com	单芯图纸Single-core drawings 单位unit:mm 修改revise:A0 视图view:
	2B系列直插头2B Series Straight Plug	型号Model BR.FGG.2B.06.CSAD82