

1. 产品尺寸图Product Dimension Drawing

标识点
Identification points

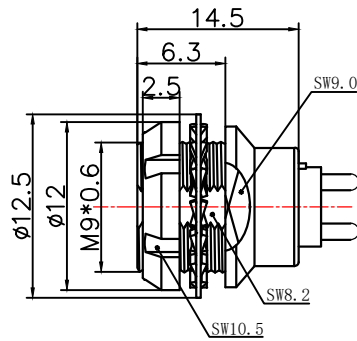

4芯孔位排列
The 3-core hole position is arranged

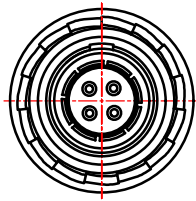
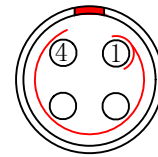

防尘帽需另外购买

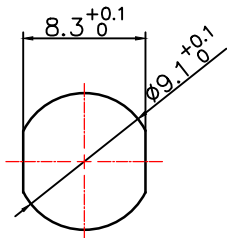

面板开孔尺寸
Panel cut-out size

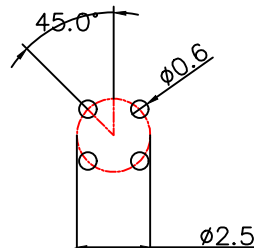

PCB开孔尺寸
PCB cut-out size

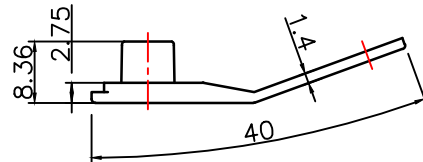

塑料防尘帽型号Model:SJ.0B.U120N1

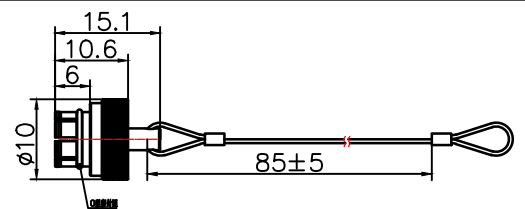

金属防尘帽型号Model:BRE.0B.CSJS.BO.85

2. 产品电器参数Product electrical parameters

防护等级 (Ingress protection) IP50(头座插合时When the headstand is plugged in)

插拔测试 (Plugging and unplugging test) <5000次

产品耐温 (The product is temperature resistant) -55° C / +250° C

盐雾腐蚀 (Salt Spray Corrosion) >72 hr

测试电压 (kV rms) 针芯-针芯 0.85

测试电压 (kV rms) 针芯-外壳 0.7

额定电流Current rating 7A

湿度 (最大值) Humidity (max) <=95 (at 60 deg C/140F)

屏蔽 (分钟) Shielding (min) 75 dB(10MHz)

屏蔽 (分钟) Shielding (min) 100 g (6 ms)

振动 Vibration 15 g (10Hz-1000Hz)

3. 环境及表面处理产品特性Environmental and surface treatment product characteristics

外壳材料 Housing material 金属件铜合金镀镍镀铬
(Metal parts: copper alloy nickel plated and chrome plated)

导体材料 Conductor material 锡青铜镀金(Pewter bronze gilding)

绝缘体材料 Insulator material PPS (可选PEEK) PPS (optional PEEK)

1: 连接器组装生产所有公差通常为0.1mm,2: 插座直接拧入螺纹孔中, 螺纹 +0.05mm
1: All tolerances are usually 0.1mm for connector assembly production, 2: The socket is screwed directly into the threaded hole, the thread is +0.05mm

	东莞市通瑞电子科技有限公司 CN-TRRE CONNECTE Dongguan Tongrui Electronic Technology Co., Ltd www.cntrre.com	单芯图纸Single-core drawings 单位unit:mm 修改revise:A0 视图view:
	0B系列直式插头0B Series Straight Plug	型号Model R.EEG.0B.104.CSN