

1. 产品尺寸图Product Dimension Drawing

标识点
Identification points

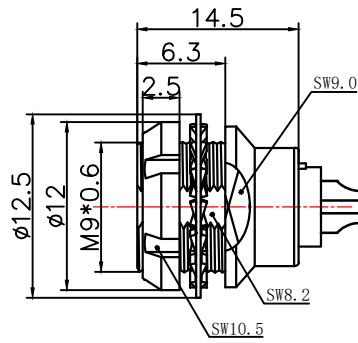

5芯孔位排列
The 5-core hole position is arranged

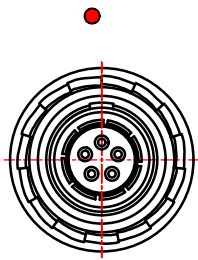
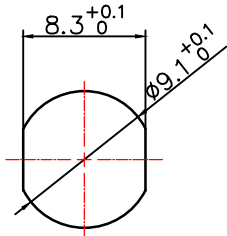
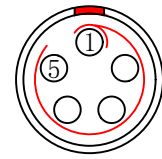

面板开孔尺寸
Panel cut-out size

防尘帽需另外购买

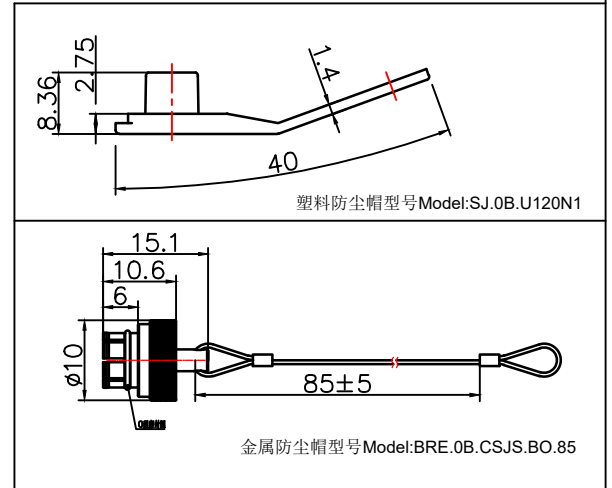

2. 产品电器参数Product electrical parameters

防护等级 (Ingress protection) IP50(头座插合时When the headstand is plugged in)

插拔测试 (Plugging and unplugging test) <math>< 5000</math>次

产品耐温 (The product is temperature resistant)

盐雾腐蚀 (Salt Spray Corrosion)

测试电压 (kV rms) 针芯-针芯 1.0

测试电压 (kV rms) 针芯-外壳 0.7

额定电流Current rating 6A

湿度 (最大值) Humidity (max)

屏蔽 (分钟) Shielding (min) 75 dB(10MHz)

屏蔽 (分钟) Shielding (min) 100 g (6 ms)

振动 Vibration 15 g (10Hz-1000Hz)

3. 环境及表面处理产品特性Environmental and surface treatment product characteristics

外壳材料 Housing material 金属件铜合金镀镍镀铬
(Metal parts: copper alloy nickel plated and chrome plated)

导体材料 Conductor material 锡青铜镀金(Pewter bronze gilding)

绝缘体材料 Insulator material PPS (可选PEEK) PPS (optional PEEK)

1: 连接器组装生产所有公差通常为0.1mm,2: 插座直接拧入螺纹孔中, 螺纹 +0.05mm
1: All tolerances are usually 0.1mm for connector assembly production, 2: The socket is screwed directly into the threaded hole, the thread is +0.05mm

TONGRUIJIAN

东莞市通瑞电子科技有限公司
CN-TRRE CONNECTE
Dongguan Tongrui Electronic Technology Co., Ltd
www.cntfre.com

0B系列直式插头0B Series Straight Plug

单芯图纸Single-core drawings

单位unit:mm 修改revise:A0

视图view:

型号Model
R.EEG.0B.105.CSL