

## SOT-23 Plastic-Encapsulate Transistors

### ● Features

- Complementary to SS8550
- Power dissipation of 300mW
- High stability and high reliability
- Meets MSL level 1, per J-STD-020, LF maximum peak of 260°C

### ● Mechanical Data

- Case: SOT-23  
Molding compound meets UL 94V-0 flammability rating, RoHS-compliant, halogen-free
- Terminals: Solder plated, solderable per MIL-STD-750, Method 2026

### ● Function Diagram

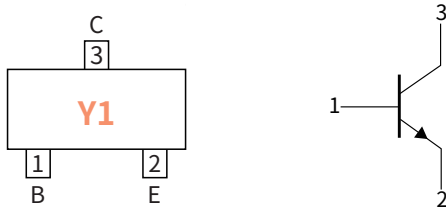

**Collector-Base Voltage**  
VCBO 40V  
**Collector Current**  
1.5 Ampere

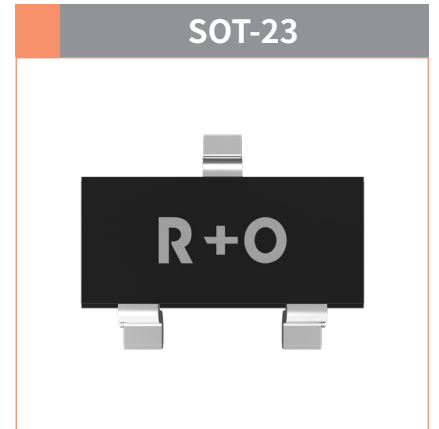

### ● Maximum Ratings (Ta=25°C Unless otherwise specified)

PARAMETER	SYMBOL	UNIT	VALUE
Collector-Base Voltage	$V_{CBO}$	V	40
Collector-Emitter Voltage	$V_{CEO}$		25
Emitter-Base Voltage	$V_{EBO}$		5.0
Collector Current	$I_C$	A	1.5
Collector Power Dissipation	$P_C$	mW	300
Storage temperature	$T_{stg}$	°C	-55 ~+150
Junction temperature	$T_j$	°C	-55 ~+150
Typical Thermal Resistance	$R_{\theta J-A}$	°C /W	417

### ● Electrical Characteristics (Ta=25°C Unless otherwise noted)

PARAMETER	SYMBOL	UNIT	Condition	Min	Max
Collector-Base Breakdown Voltage	$V_{(BR)CBO}$	V	$I_C=100\mu A, I_E=0$	40	—
Collector-Emitter Breakdown Voltage	$V_{(BR)CEO}$		$I_C=100\mu A, I_B=0$	25	—
Emitter-Base Breakdown Voltage	$V_{(BR)EBO}$		$I_E=100\mu A, I_C=0$	5.0	—
Collector-Base cut-off current	$I_{CBO}$	$\mu A$	$V_{CB}=40V, I_E=0$	—	0.1
Collector-Emitter cut-off current	$I_{CEO}$		$V_{CE}=20V, I_B=0$	—	0.1
Emitter-Base cut-off current	$I_{EBO}$		$V_{EB}=5.0V, I_C=0$	—	0.1
DC Current Gain	$h_{FE(1)}$	—	$I_C=100mA, V_{CE}=1.0V$	120	350
	$h_{FE(2)}$		$I_C=800mA, V_{CE}=1.0V$	40	—
Collector-Emitter Saturation Voltage	$V_{CE(sat)}$	V	$I_C=800mA, I_B=80mA$	—	0.5
Base-Emitter Saturation Voltage	$V_{BE(sat)}$	V	$I_C=800mA, I_B=80mA$	—	1.2

## ● Classification Of $h_{FE}$

RANK	L	H	J
Range	120-200	200-350	300-400

## ● Small-signal Characteristics

ITEM	SYMBOL	Condition	UNIT	Min	Max
Transition frequency	$f_T$	$I_C=50mA, V_{CE}=10V, f=30MHz$	MHz	100	—

## ● Ordering Information

PACKAGE	PACKAGE CODE	UNIT WEIGHT(g)	REEL(pcs)	BOX(pcs)	CARTON(pcs)	DELIVERY MODE
SOT-23	R1	0.008	3000	30000	120000	7"

## ● Ratings And Characteristics Curves (Ta=25°C Unless otherwise specified)

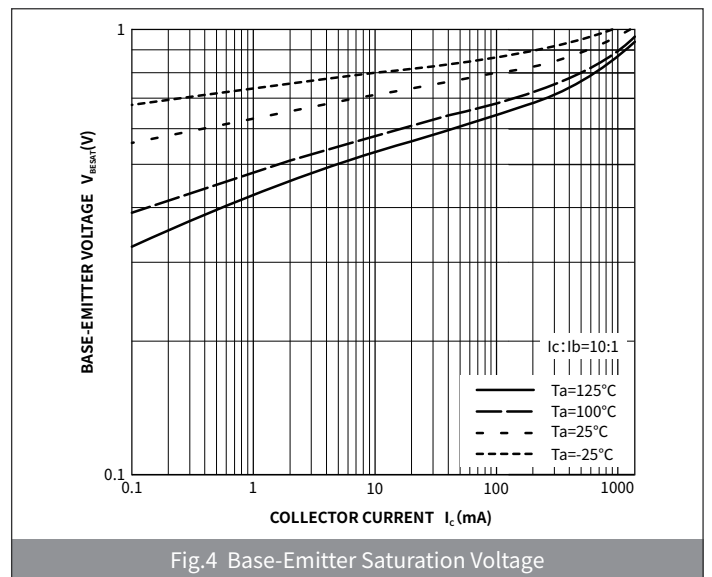
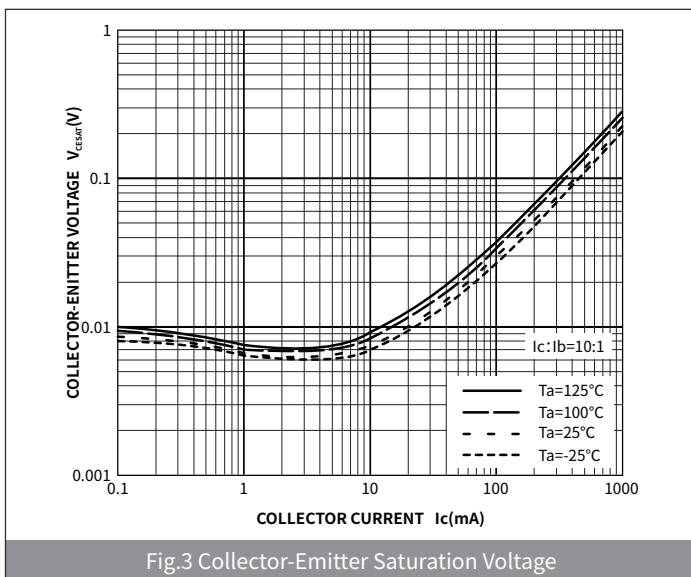
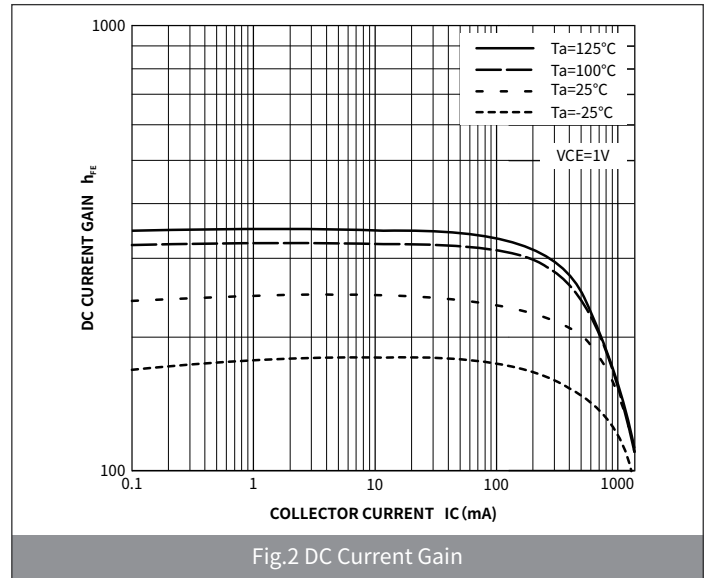
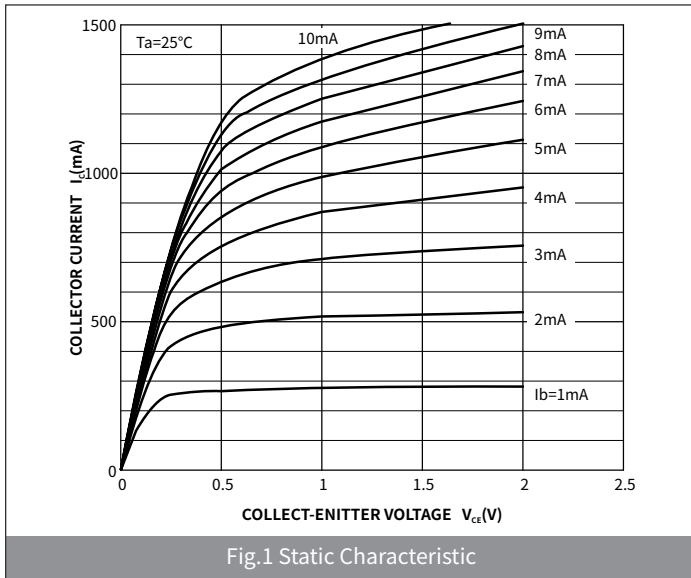

## ● Ratings And Characteristics Curves (Ta=25°C Unless otherwise specified)

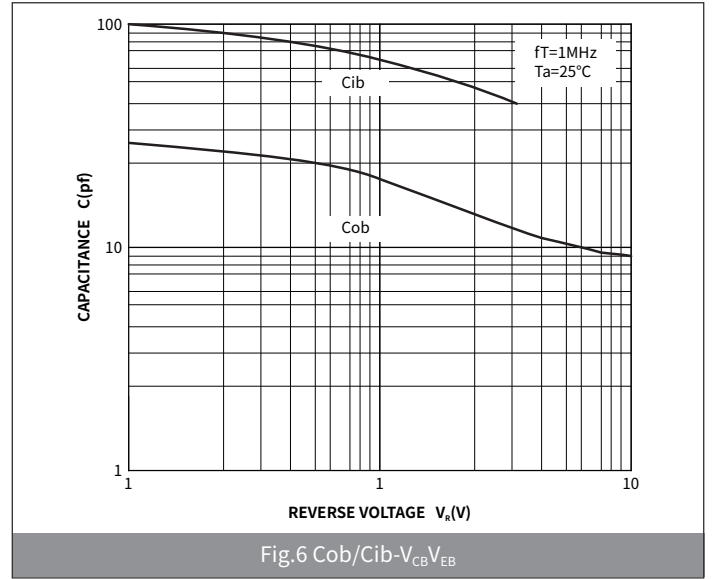
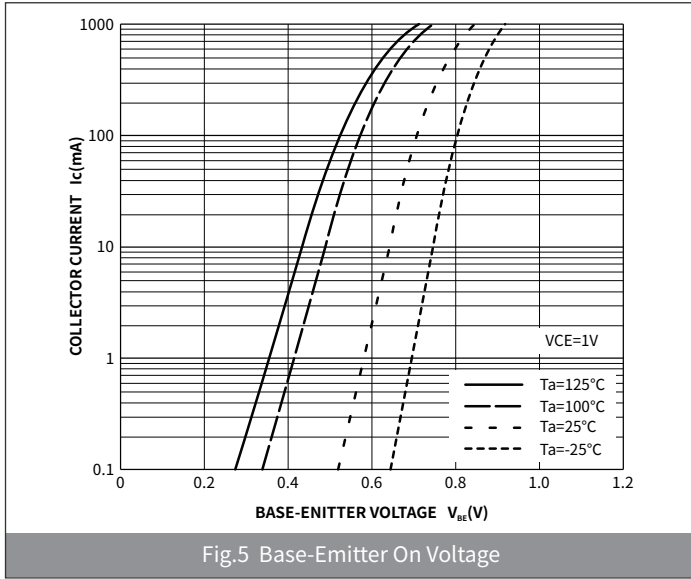

## ● Package Outline Dimensions (SOT-23)

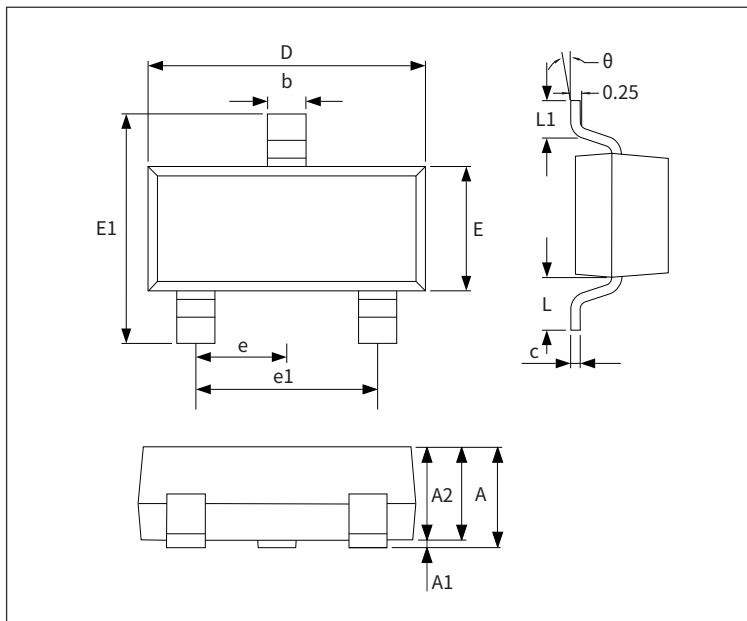

Symbol	Dimensions			
	Millimeters		Inches	
	Min.	Max.	Min.	Max.
A	0.90	1.15	0.035	0.045
A1	-	0.10	-	0.004
A2	0.90	1.05	0.035	0.041
b	0.30	0.50	0.012	0.020
c	0.10	0.20	0.004	0.008
D	2.80	3.00	0.110	0.118
E	1.20	1.40	0.047	0.055
E1	2.25	2.55	0.089	0.100
e	0.950TYP		0.037TYP	
e1	1.80	2.00	0.071	0.079
L	0.550REF		0.022REF	
L1	0.30	0.50	0.012	0.020
θ	-	8°	-	8°

## ● Suggested Pad Layout

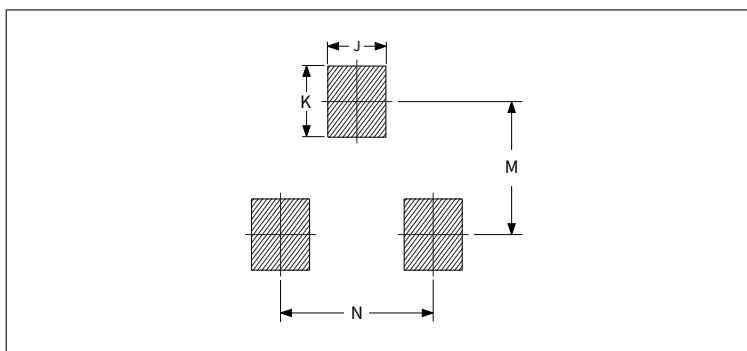

Symbol	Dimensions			
	Millimeters		Inches	
	Min.	Max.	Min.	Max.
J	0.75	0.85	0.030	0.033
K	0.85	0.95	0.033	0.037
M	1.95	2.05	0.077	0.081
N	1.85	1.95	0.073	0.077