

Product Summary

$V_{(BR)DSS}$	$R_{DS(on)TYP}$	I_D
100V	4Ω@10V	170mA
	4.3Ω@4.5V	



合肥矽普半导体

Siliup Semiconductor Technology Co.Ltd

技术 品质 服务

www.siliup.com

Feature

- High power and current handing capability
- Surface mount package
- ESD protected 2KV

Application

- Battery Switch
- DC/DC Converter

Package

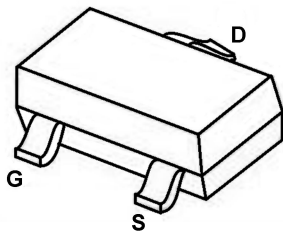

SOT-23

Circuit diagram

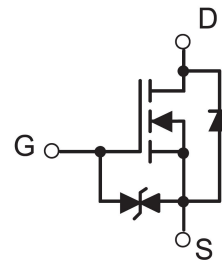

Marking

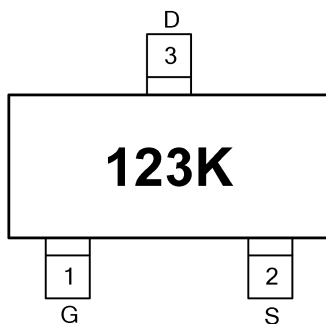

123K

:Device Code

Order Information

Device	Package	Unit/Tape
BSS123K	SOT-23	3000

Absolute maximum ratings (Ta=25°C, unless otherwise noted)

Parameter	Symbol	Value	Unit
Drain-Source Voltage	V _{DSS}	100	V
Gate-Source Voltage	V _{GSS}	±20	V
Continuous Drain Current	I _D	170	mA
Pulse Drain Current Tested	I _{DM}	680	mA
Power Dissipation	P _D	350	mW
Thermal Resistance Junction-to-Ambient	R _{θJA}	357	°C/W
Storage Temperature Range	T _{STG}	-55 to 150	°C
Operating Junction Temperature Range	T _J	-55 to 150	°C

Electrical characteristics (Ta=25°C, unless otherwise noted)

Parameter	Symbol	Conditions	Min.	Typ.	Max.	Unit
Static Characteristics						
Drain-Source Breakdown Voltage	BV _{DSS}	V _{GS} =0V , I _D =250μA	100	-	-	V
Drain-Source Leakage Current	I _{DSS}	V _{DS} =80V , V _{GS} =0V	-	-	1	uA
Gate-Source Leakage Current	I _{GSS}	V _{GS} =±20V , V _{DS} =0V	-	-	±10	uA
Gate Threshold Voltage	V _{GS(th)}	V _{DS} =V _{GS} , I _D =250μA	1.3	1.7	2.5	V
Static Drain-Source On-Resistance	R _{DS(ON)}	V _{GS} =10V, I _D =250mA	-	4	6	Ω
		V _{GS} =4.5V, I _D =200mA	-	4.3	9	
Dynamic characteristics						
Input Capacitance	C _{iss}	V _{DS} =25V , V _{GS} =0V , f=1MHz	-	60	-	pF
Output Capacitance	C _{oss}		-	15	-	
Reverse Transfer Capacitance	C _{rss}		-	6	-	
Total Gate Charge	Q _g	V _{DS} =10V , V _{GS} =10V , I _D =220mA	-	2	-	nC
Gate-Source Charge	Q _{gs}		-	0.25	-	
Gate-Drain Charge	Q _{gd}		-	0.4	-	
Switching Characteristics						
Turn-On Delay Time	t _{d(on)}	V _{DD} =30V V _{GS} =10V , R _G =50Ω , I _D =280mA	-	8	-	nS
Turn-On Rise Time	t _r		-	8	-	
Turn-Off Delay Time	t _{d(off)}		-	13	-	
Turn-Off Fall Time	t _f		-	16	-	
Source-Drain Diode characteristics						
Diode Forward Voltage	V _{SD}	V _{GS} =0V , I _S =1A , T _J =25°C	-	-	1.2	V

Typical Characteristics

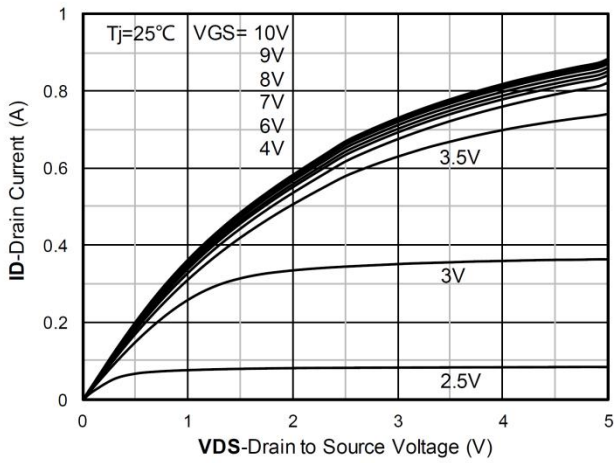

Output Characteristics

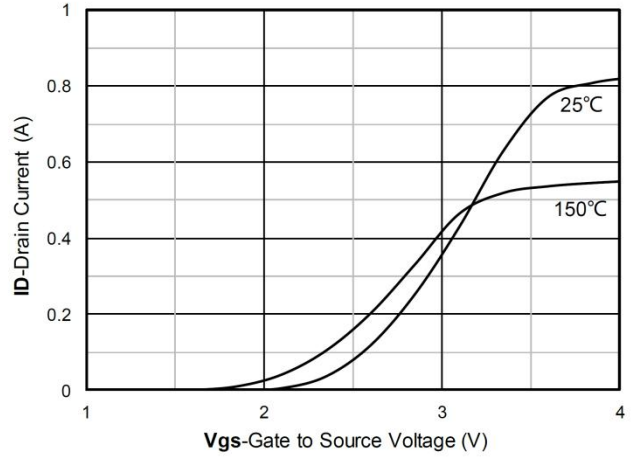

Transfer Characteristics

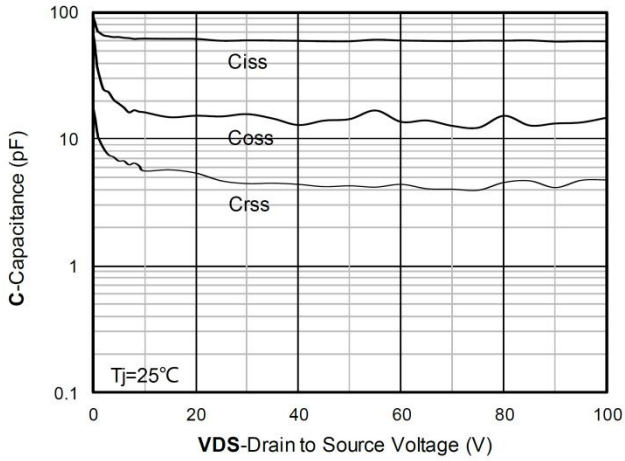

Capacitance Characteristics

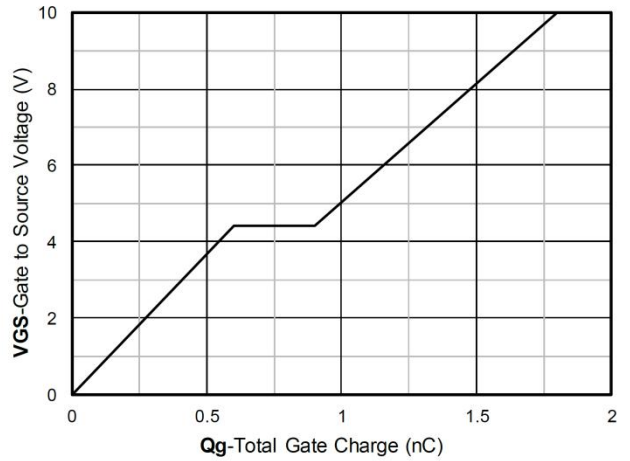

Gate Charge

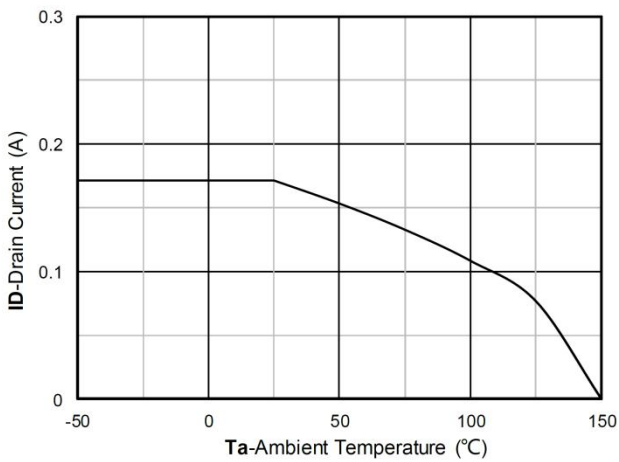

Current dissipation

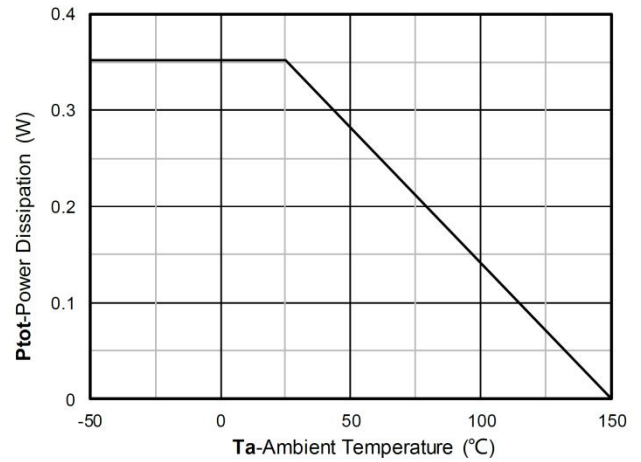

Power dissipation

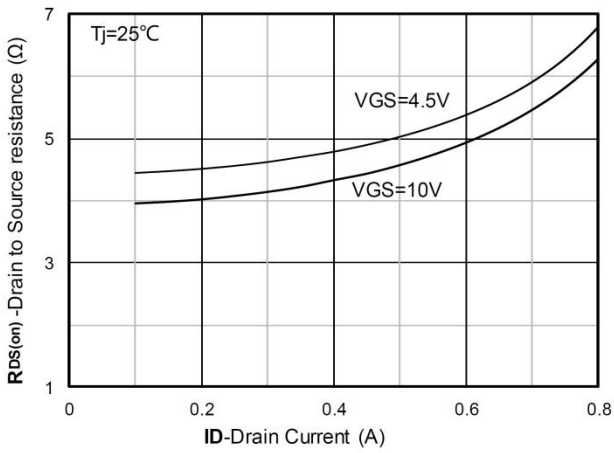

RDS(on) VS Drain Current

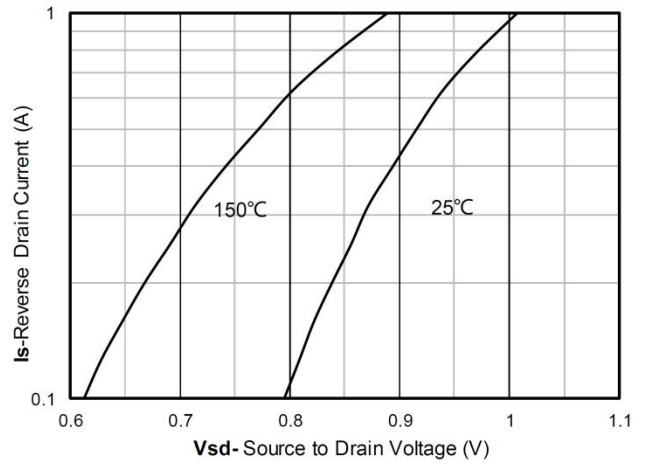

Forward characteristics of reverse diode

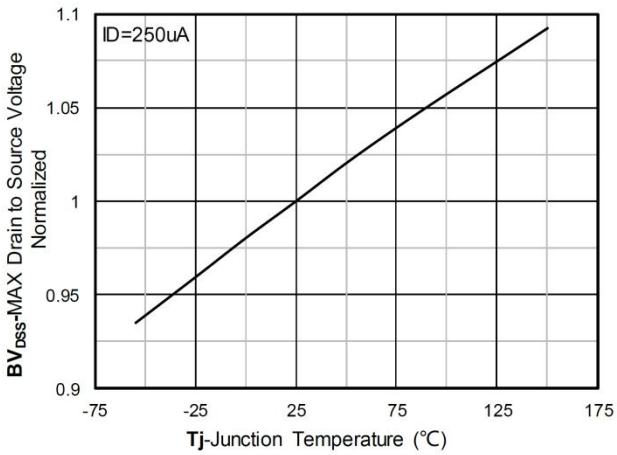

Normalized breakdown voltage

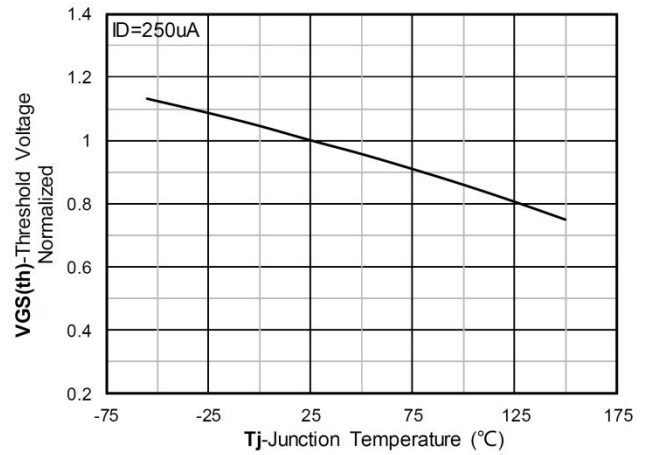

Normalized Threshold voltage

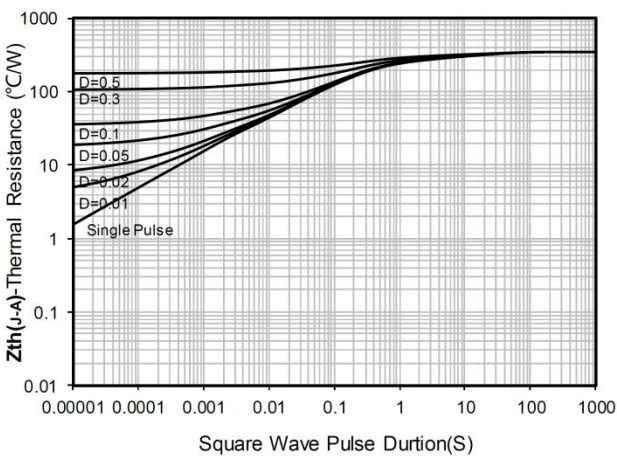

Maximum Transient Thermal Impedance

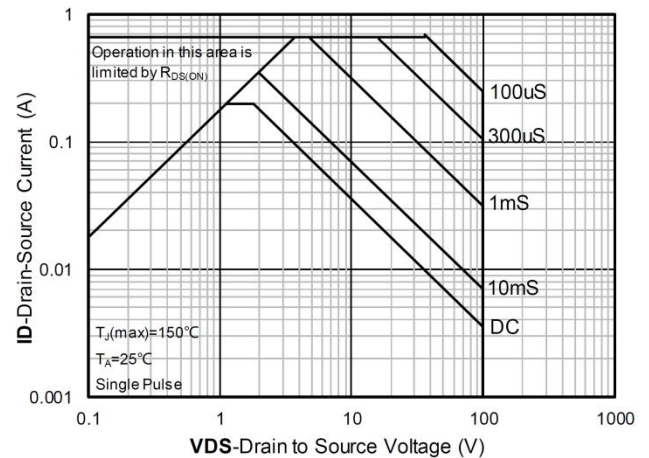

Safe Operation Area

SOT-23 Package Information

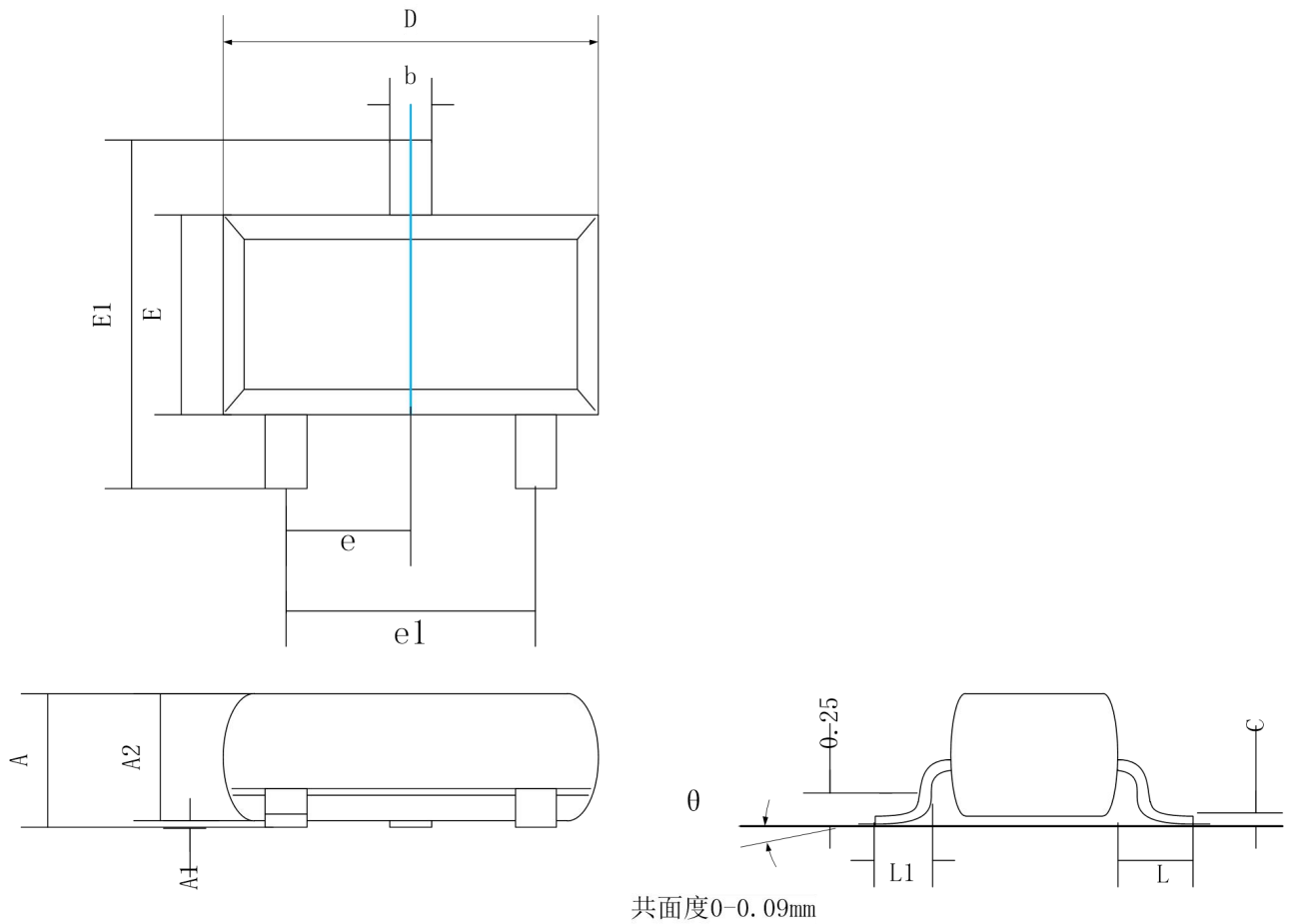

Symbol	Dimensions In Millimeters	
	Min.	Max.
A	0.90	1.15
A1	0.00	0.10
A2	0.90	1.05
b	0.30	0.50
c	0.08	0.15
D	2.80	3.00
E	1.20	1.40
E1	2.25	2.55
e	0.95 REF.	
e1	1.80	2.00
L	0.55 REF.	
L1	0.30	0.50
θ	0°	8°