

ROHS

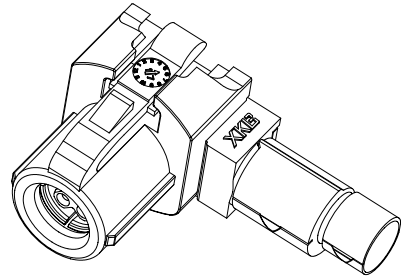

3D View

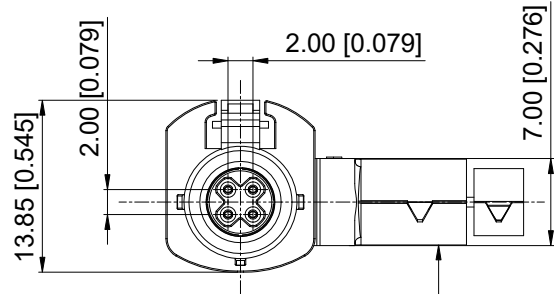
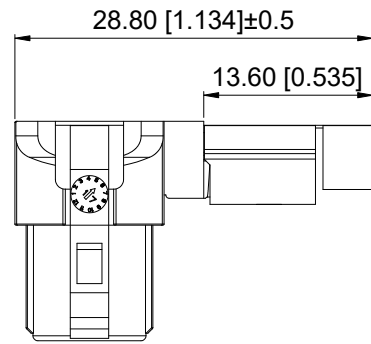

State after crimp

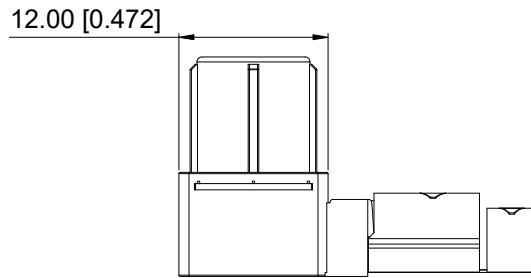
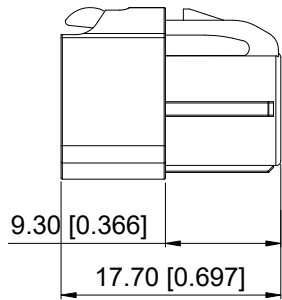

1		2		3		4	
REV.	ECN NO.	LOCATION	REVISIONS		DATE	DESIGN	
A0	N/A		INITIAL RELEASE		2024.09.18		

Specifications(规格):

- 1.Impedance(特性阻抗) : 100Ω;
- 2.Frequency (工作频率) : DC~2GHz;
- 3.Return Loss (回波损耗) : ≥ 20dB @1GHz;
- 4.Insulation resistance(绝缘阻抗) : ≥100MΩ;
- 5.Dielectric withstand voltage (介质耐电压) : 250V AC;
- 6.Mating cycles (耐久性) : ≥25 cycles;
- 7.Engagement force(啮合力) : ≤ 30N;
- 8.Retention force latch(保持力) : ≥110N;
- 9.Temperature range(使用温度): -40℃~+105℃;

PART NO.:

XH4PLF1R5-NL06-X

Code: A~Z

BOM List:

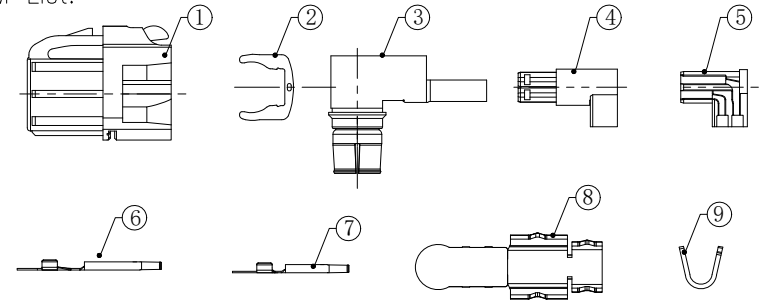

9	Outer Ferrule	Copper Alloy	Ni PLATED	1 PC	2KPCS/R
8	Cover	Copper Alloy	Ni PLATED	1 PC	
7	Center Conductor-2	Copper Alloy	Gold PLATED	2 PCS	5KPCS/R
6	Center Conductor-1	Copper Alloy	Gold PLATED	2 PCS	5KPCS/R
5	Dielectric-2	PA66		1 PC	
4	Dielectric-1	PA66		1 PC	
3	Outer Conductor	Zinc Alloy	Ni PLATED	1 SET	
2	Secondary Lock-1	SUS		1 PC	
1	Housing	PBT		1 PC	
NO.	SPEC.	MATERIAL	FINISH (Contact)	Q'TY	Note

www.helloxkb.com www.helloxkb.cn www.xk-dg.cn



DESIGN	希文	VIEW:	
CHECKED		UNIT:	mm/in
APPROVED		SIZE:	A4

ANGULAR	±5°
X.	±0.50
X.x	±0.30
X.xx	±0.20
X.xxx	±0.10

UNSPECIFIED TOLERANCES

MODEL TYPE:		
HSD 4P Female R/A Connector for 535 Cable		
PART NO.:		
XH4PLF1R5-NL06-X		
DWG NO.:		
X-XH4PLF1R5-NL06-X		

XKB INDUSTRIAL PRECISION CO.,LIMITED

SCALE	PAGE	REVISION
N/A	1/2	A0

1

2

3

4

REVISIONS					
REV.	ECN NO.	LOCATION	DESCRIPTION	DATE	DESIGN
A0	N/A		INITIAL RELEASE	2024.09.18	

## Code List:

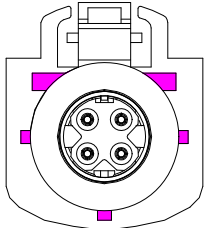
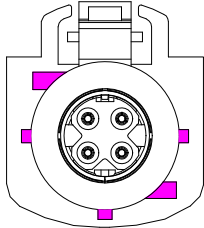
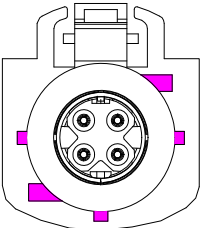
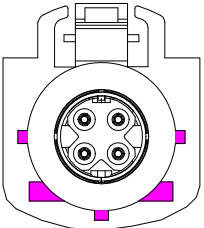
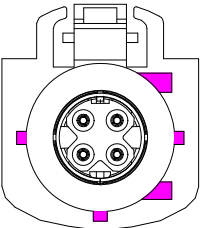
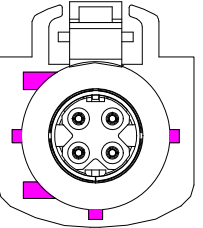
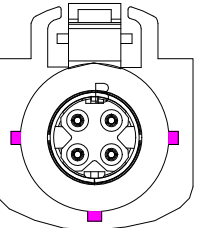
Colde							
	A	B	C	D	E	F	Z
Color/RAL-No.	Black/9005	White/9001	Blue/5005	Bordeaux/4004	Green/6002	Brown/8011	Water Blue/5021
PART NO.	XH4PLF1R5-NL06-A	XH4PLF1R5-NL06-B	XH4PLF1R5-NL06-C	XH4PLF1R5-NL06-D	XH4PLF1R5-NL06-E	XH4PLF1R5-NL06-F	XH4PLF1R5-NL06-Z

ANGULAR	±5°
X.	±0.40
X.x	±0.30
X.xx	±0.20
X.xxx	±0.15
UNSPECIFIED TOLERANCES	



DESIGN	希文
CHECKED	
APPROVED	

VIEW:	
UNIT:	mm/in
SIZE:	A4

MODEL TYPE:	HSD 4P Female R/A Connector for 535 Cable		
PART NO.:	XH4PLF1R5-NL06-X		
DWG NO.:	X-XH4PLF1R5-NL06-X		

NOTE: ALL RIGHTS RESERVED,BANNED COPY!

www.helloxkb.com

www.helloxkb.cn

www.xk-dg.cn

XKB INDUSTRIAL PRECISION CO.,LIMITED

SCALE	PAGE	REVISION
N/A	2/2	A0

1

2

3

4