

# S-SM8SxxCA Series

## Surface Mount Transient Voltage Suppressor

### 1. FEATURES

- Junction passivation optimized design passivated anisotropic rectifier technology
- $T_J=175^{\circ}\text{C}$  capability suitable for high reliability and automotive requirement
- Low leakage current
- Low forward voltage drop
- Meets RoHS2.0 (2011/65/EU)
- Meets MSL level 1, per J-STD-020
- Meet ISO7637-2 surge specification
- AEC-Q101 qualified
- S- prefix for automotive and other applications requiring unique site and control change requirements; AEC-Q101 qualified and PPAP capable

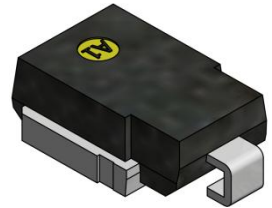

### 2. MECHANICAL DATA

**Case:** DO-218AB

Molding compound meets UL 94V-0 flammability rating

Base P/NHE3-RoHS-compliant, AEC-Q101 qualified

**Terminals:** Matte tin plated leads, solderable per J-STD-002

**Polarity:** Heatsink is anode

**Weight:** 2.7g

### 3. MAXIMUM RATINGS( $T_C=25^{\circ}\text{C}$ )

Parameter	Symbol	Limit	Unit
Peak pulse power dissipation at 10/1000 $\mu\text{s}$ waveform	P <sub>PPM</sub>	6600	W
Peak pulse power dissipation at 10/10000 $\mu\text{s}$ waveform		5200	W
Power dissipation on infinite heat sink at $T_C=25^{\circ}\text{C}$	P <sub>D</sub>	8.0	W
Peak forward surge current, 8.3ms single half sine-wave	I <sub>FSM</sub>	700	A
Operating junction and storage temperature range	T <sub>J</sub> , T <sub>STG</sub>	-55 ~ +175	$^{\circ}\text{C}$
Typical thermal resistance junction to case	R <sub><math>\theta</math>JC</sub>	0.9	$^{\circ}\text{C}/\text{W}$

#### 4. ELECTRICAL CHARACTERISTICS

Bi-directional Part Number	Device Marking Code	Reverse Stand-off Voltage VRWM (V)	Breakdown Voltage VBR (V) Min. @IT	Breakdown Voltage VBR (V) Max. @IT	Test Current IT (mA)	Maximum Clamping Voltage VC(V)@IPP	Peak Pulse Current Ipp (A)	Reverse Leakage @VRWM IR (uA)
S-SM8S10CA	SM8S10CA	10.0	11.1	12.3	5	17.0	388	15
S-SM8S11CA	SM8S11CA	11.0	12.2	13.5	5	18.2	363	10
S-SM8S12CA	SM8S12CA	12.0	13.3	14.7	5	19.9	332	10
S-SM8S13CA	SM8S13CA	13.0	14.4	15.9	5	21.5	307	10
S-SM8S14CA	SM8S14CA	14.0	15.6	17.2	5	23.2	284	10
S-SM8S15CA	SM8S15CA	15.0	16.7	18.5	5	24.4	270	10
S-SM8S16CA	SM8S16CA	16.0	17.8	19.7	5	26.0	253	10
S-SM8S17CA	SM8S17CA	17.0	18.9	20.9	5	27.6	239	10
S-SM8S18CA	SM8S18CA	18.0	20.0	22.1	5	29.2	226	10
S-SM8S20CA	SM8S20CA	20.0	22.2	24.5	5	32.4	204	10
S-SM8S22CA	SM8S22CA	22.0	24.4	26.9	5	35.5	186	10
S-SM8S24CA	SM8S24CA	24.0	26.7	29.5	5	38.9	170	10
S-SM8S26CA	SM8S26CA	26.0	28.9	31.9	5	42.1	157	10
S-SM8S28CA	SM8S28CA	28.0	31.1	34.4	5	45.4	145	10
S-SM8S30CA	SM8S30CA	30.0	33.3	36.8	5	48.4	136	10
S-SM8S32CA	SM8S32CA	32.0	35.5	39.4	5	51.4	128.5	10
S-SM8S33CA	SM8S33CA	33.0	36.7	40.6	5	53.3	124	10
S-SM8S36CA	SM8S36CA	36.0	40.0	44.2	5	58.1	114	10
S-SM8S40CA	SM8S40CA	40.0	44.4	49.1	5	64.5	102	10
S-SM8S43CA	SM8S43CA	43.0	47.8	52.8	5	69.4	95.1	10
S-SM8S48CA	SM8S48CA	48.0	53.2	58.7	5	77.4	85	10

## 5. ELECTRICAL CHARACTERISTICS CURVES

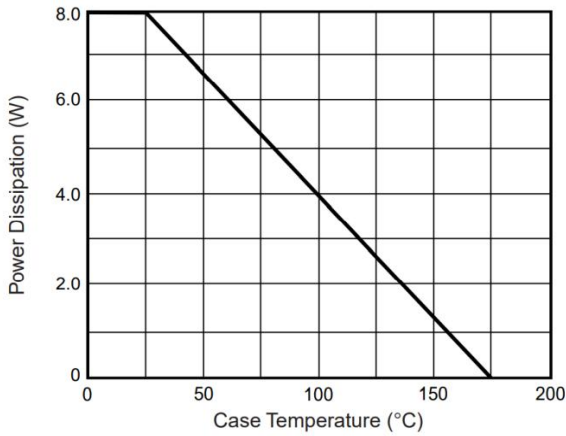

Fig.1: Power Derating Curve

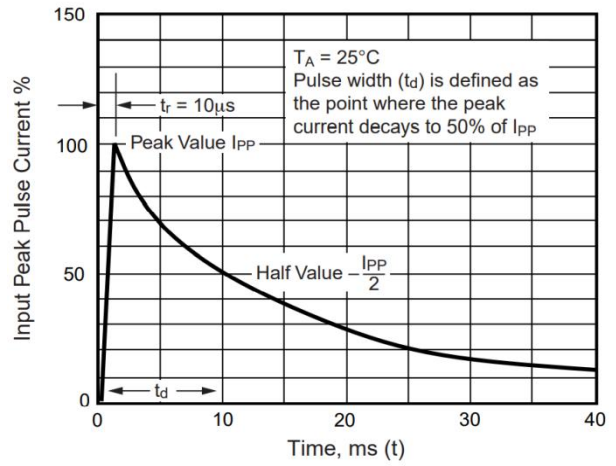

Fig.2: Pulse Waveform

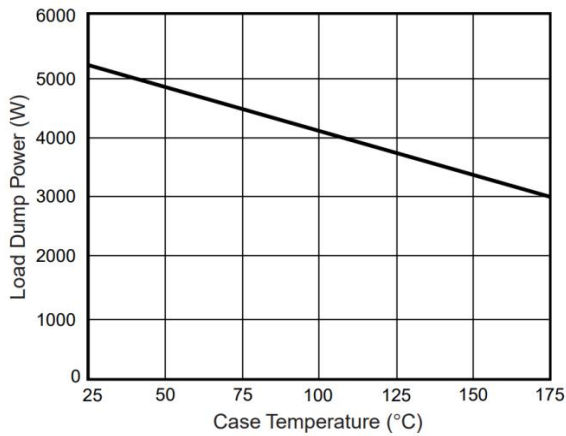

Fig.3: Load Dump Power Characteristics  
(10 ms Exponential Waveform)

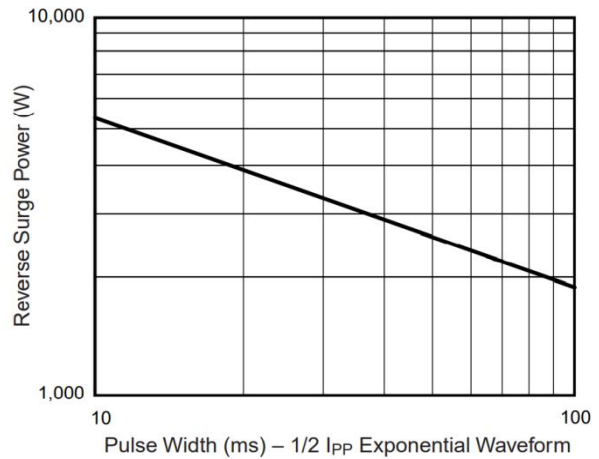
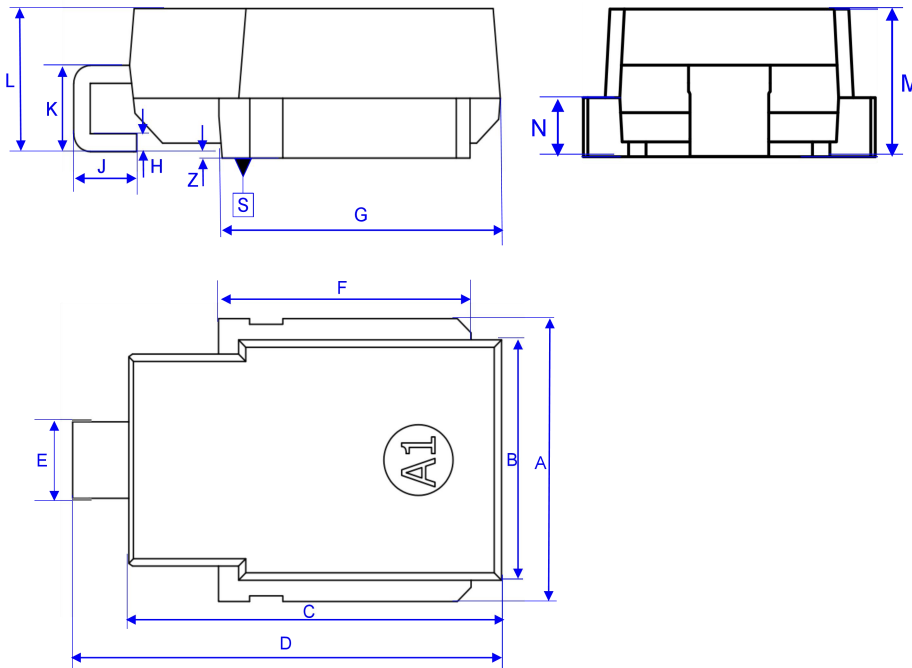

Fig.4: Reverse Power Capability

### 6. OUTLINE AND DIMENSIONS



DO-218AB			
DIM	Min	Max	Typ.
A	9.5	10.5	10.0
B	8.3	8.7	8.5
C	13.3	13.7	13.5
D	15.0	16.0	15.5
E	2.4	3.1	2.7
F	8.7	9.3	9.0
G	9.8	10.4	10.1
H	0.5	0.7	0.6
J	1.6	2.2	2.0
K	2.5	3.5	3.1
L	4.8	5.8	5.0
M	4.9	5.2	5.0
N	1.9	2.1	2.0
Z	-0.15	0.15	0.00
All Dimensions in mm			

### 7. SOLDERING FOOTPRINT

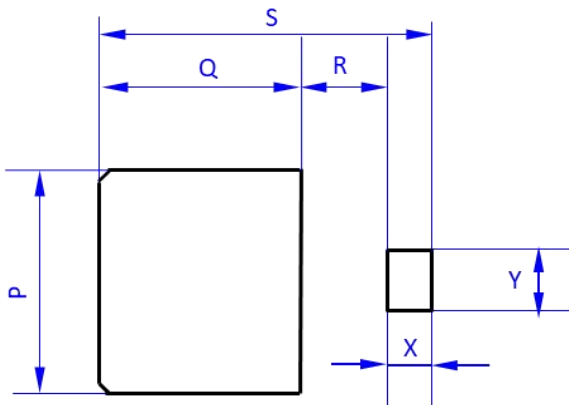

DO-218AB			
DIM	Min	Max	Typ.
P	9.5	10.5	10.0
Q	8.7	9.3	9.0
R	3.2	3.8	3.5
S	14.1	14.9	14.5
X	1.7	2.3	2.0
Y	2.4	3.0	2.7
All Dimensions in mm			

**DISCLAIMER**

- Curve guarantee in the specification. The curve of test items with electric parameter is used as quality guarantee. The curve of test items without electric parameter is used as reference only.
- Before you use our Products for new Project, you are requested to carefully read this document and fully understand its contents. LRC shall not be in any way responsible or liable for failure, malfunction or accident arising from the use of any LRC's Products against warning, caution or note contained in this document.
- All information contained in this document is current as of the issuing date and subject to change without any prior notice. Before purchasing or using LRC's Products, please confirm the latest information with a LRC sales representative.