

# T SF25N50MD

## 500V N-Channel MOSFET

### General Description

This Power MOSFET is produced using Truesemi's advanced planar stripe DMOS technology. This advanced technology has been especially tailored to minimize on-state resistance, provide superior switching performance, and withstand high energy pulse in the avalanche and commutation mode. These devices are well suited for high efficiency switched mode power supplies, active power factor correction based on half bridge topology.

### Features

- 25A,500V,Max. $R_{DS(on)}=0.25\Omega @ V_{GS}=10V$
- Low gate charge(typical 70nC)
- High ruggedness
- Fast switching
- 100% avalanche tested
- Improved dv/dt capability

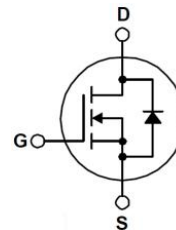

### Absolute Maximum Ratings $T_J=25^\circ\text{C}$ unless otherwise specified

Symbol	Parameter	Value	Units
$V_{DSS}$	Drain-Source Voltage	500	V
$V_{GS}$	Gate-Source Voltage	$\pm 30$	V
$I_D$	Drain Current	$T_C = 25^\circ\text{C}$	25
		$T_C = 100^\circ\text{C}$	13
$I_{DM}$	Pulsed Drain Current	80	A
$E_{AS}$	Single Pulsed Avalanche Energy (L=0.4mH)	900	mJ
$P_D$	Power Dissipation ( $T_C = 25^\circ\text{C}$ )	37	W
$T_J, T_{STG}$	Operating and Storage Temperature Range	-55 to +175	$^\circ\text{C}$

### Thermal Resistance Characteristics

Symbol	Parameter	Typ.	Max.	Units
$R_{\theta JC}$	Thermal Resistance, Junction-to-Case	--	3.4	$^\circ\text{C}/\text{W}$
$R_{\theta JA}$	Thermal Resistance, Junction-to-Ambient	--	62.5	$^\circ\text{C}/\text{W}$

**Electrical Characteristics**  $T_J=25\text{ }^\circ\text{C}$  unless otherwise specified

Symbol	Parameter	Test Conditions	Min	Typ	Max	Units
--------	-----------	-----------------	-----	-----	-----	-------

**On Characteristics**

$V_{GS(th)}$	Gate Threshold Voltage	$V_{DS} = V_{GS}, I_D = 250\text{ }\mu\text{A}$	2.0	--	4.0	V
$R_{DS(ON)}$	Static Drain-Source On-Resistance	$V_{GS} = 10\text{ V}, I_D = 20\text{ A}$	--	0.21	0.25	$\Omega$

**Off Characteristics**

$BV_{DSS}$	Drain-Source Breakdown Voltage	$V_{GS} = 0\text{ V}, I_D = 250\text{ }\mu\text{A}$	500	--	--	V
$I_{DSS}$	Zero Gate Voltage Drain Current	$V_{DS} = 150\text{ V}, V_{GS} = 0\text{ V}$	--	--	1	$\mu\text{A}$
		$V_{DS} = 150\text{ V}, T_J = 100\text{ }^\circ\text{C}$	--	--	100	$\mu\text{A}$
$I_{GSSF}$	Gate-Body Leakage Current, Forward	$V_{GS} = 20\text{ V}, V_{DS} = 0\text{ V}$	--	--	100	nA
$I_{GSSR}$	Gate-Body Leakage Current, Reverse	$V_{GS} = -20\text{ V}, V_{DS} = 0\text{ V}$	--	--	-100	nA

**Dynamic Characteristics**

$C_{iss}$	Input Capacitance	$V_{DS} = 75\text{ V}, V_{GS} = 0\text{ V},$ $f = 1.0\text{ MHz}$	--	3900	--	pF
$C_{oss}$	Output Capacitance		--	400	--	pF
$C_{rss}$	Reverse Transfer Capacitance		--	40	--	pF

**Switching Characteristics**

$t_{d(on)}$	Turn-On Time	$V_{DS} = 75\text{ V}, I_D = 25\text{ A},$ $R_G = 10\text{ }\Omega$	--	100	--	ns
$t_r$	Turn-On Rise Time		--	400	--	ns
$t_{d(off)}$	Turn-Off Delay Time		--	100	--	ns
$t_f$	Turn-Off Fall Time		--	100	--	ns
$Q_g$	Total Gate Charge	$V_{DS} = 75\text{ V}, I_D = 25\text{ A},$ $V_{GS} = 10\text{ V}$	--	70	--	nC
$Q_{gs}$	Gate-Source Charge		--	18	--	nC
$Q_{gd}$	Gate-Drain Charge		--	35	--	nC

**Source-Drain Diode Maximum Ratings and Characteristics**

$I_S$	Continuous Source-Drain Diode Forward Current	--	--	25	A	
$I_{SM}$	Pulsed Source-Drain Diode Forward Current	--	--	80		
$V_{SD}$	Source-Drain Diode Forward Voltage	$I_S = 25\text{ A}, V_{GS} = 0\text{ V}$	--	--	1.5	V
$t_{rr}$	Reverse Recovery Time	$I_S = 25\text{ A}, V_{GS} = 0$	--	500	--	ns
$Q_{rr}$	Reverse Recovery Charge	$V\text{ di}_F/\text{dt} = 100\text{ A}/\mu\text{s}$	--	7.2	--	$\mu\text{C}$

Typical Characteristics

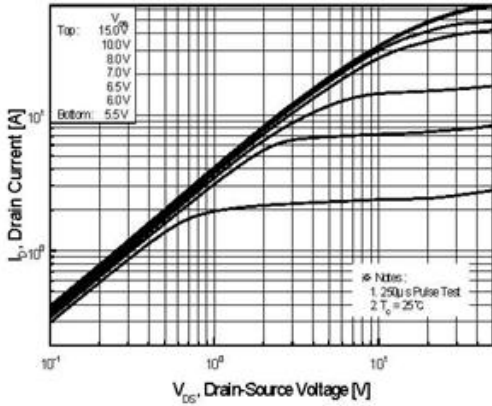

Figure 1. On-Region Characteristics

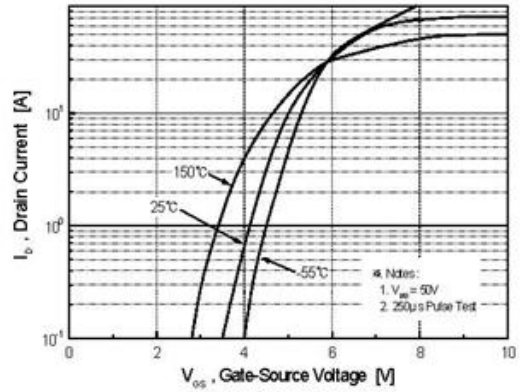

Figure 2. Transfer Characteristics

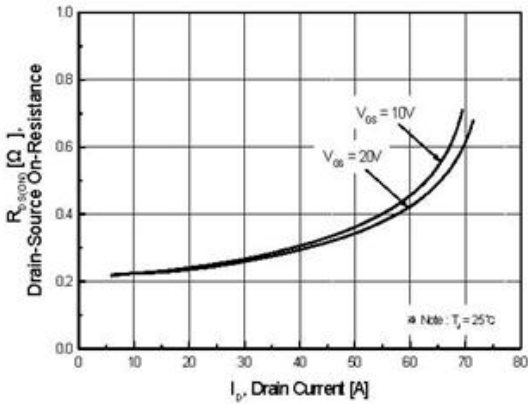

Figure 3. On-Resistance Variation vs

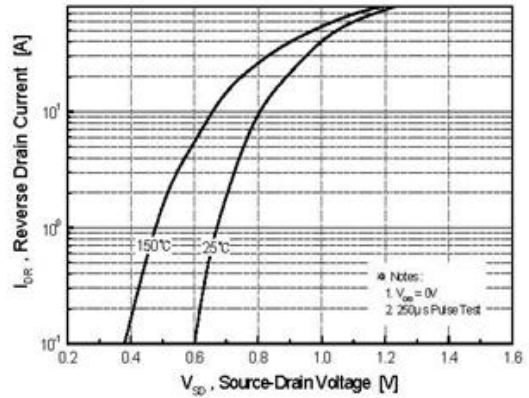

Figure 4. Body Diode Forward Voltage

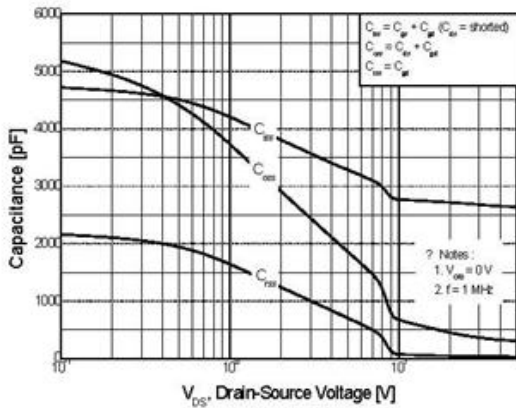

Figure 5. Capacitance Characteristics

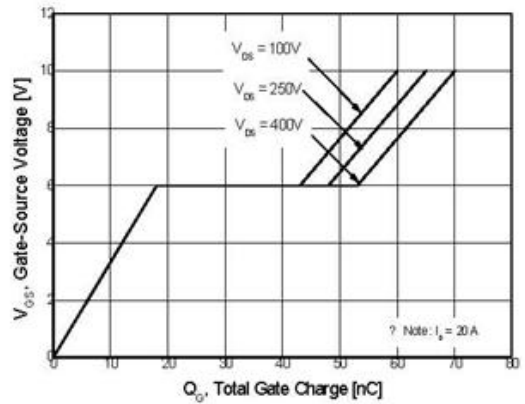

Figure 6. Gate Charge Characteristics

Typical Characteristics

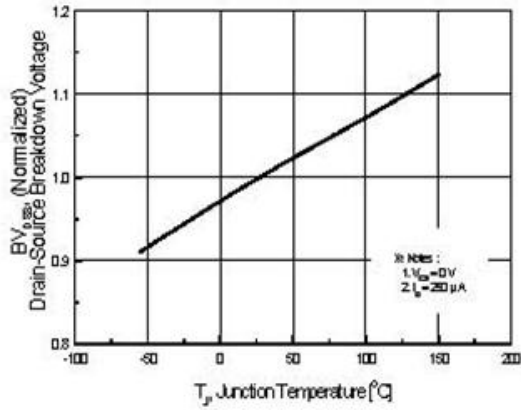

Figure 7. Breakdown Voltage Variation

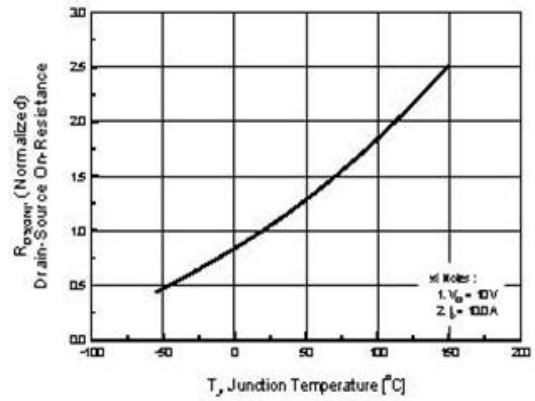

Figure 8. On-Resistance Variation

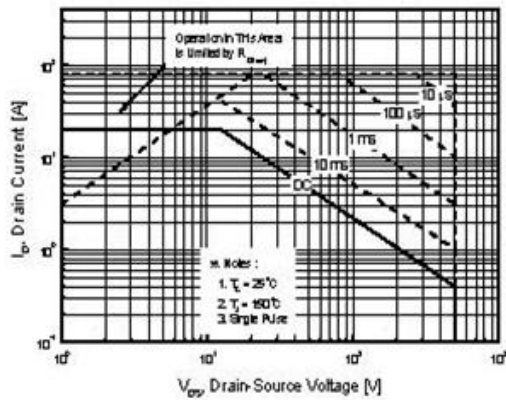

Figure 9. Maximum Safe Operating Area

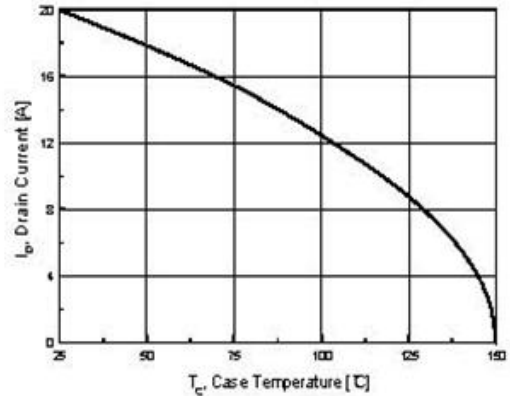

Figure 10. Maximum Drain Current vs Case Temperature

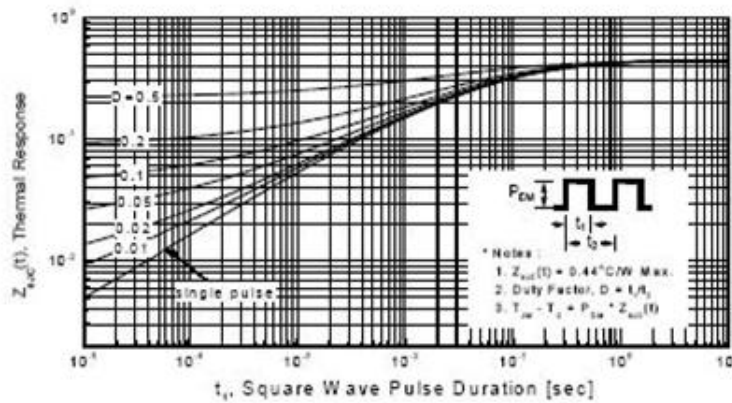

Figure 11. Transient Thermal Response Curve

Fig 12. Gate Charge Test Circuit & Waveform

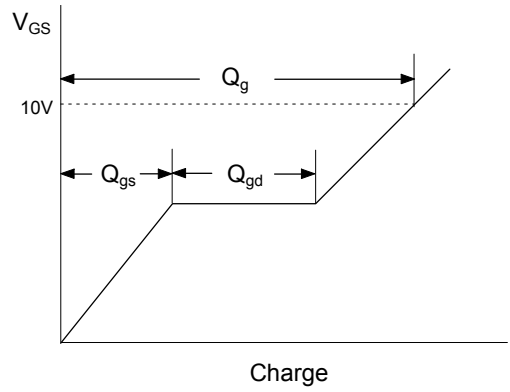
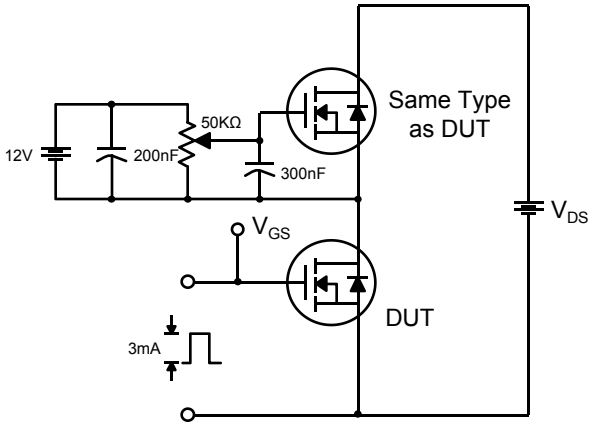

Fig 13. Resistive Switching Test Circuit & Waveforms

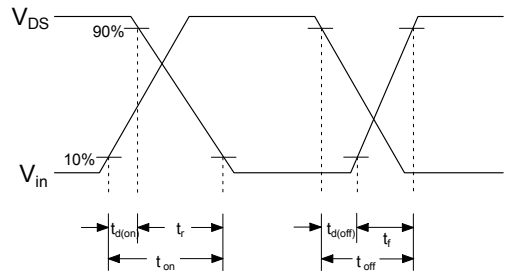
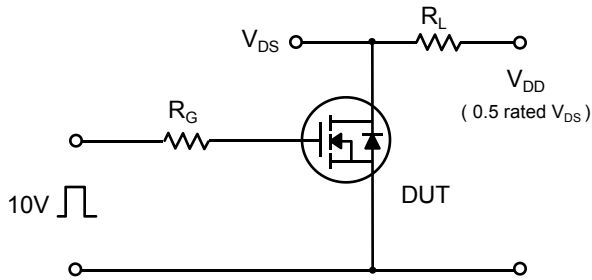

Fig 14. Unclamped Inductive Switching Test Circuit & Waveforms

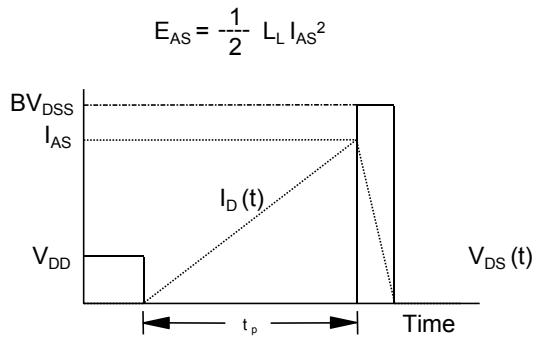
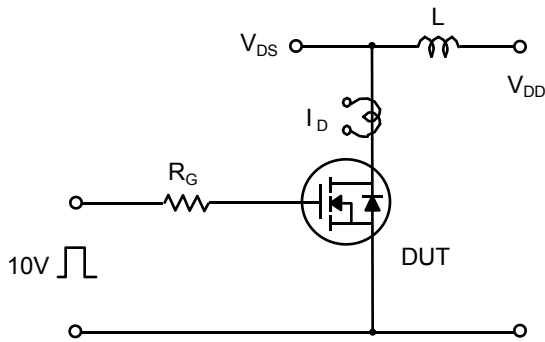

Fig 15. Peak Diode Recovery dv/dt Test Circuit & Waveforms

