

Features

- Advanced high cell density Trench technology
- Super Low Gate Charge
- Excellent CdV/dt effect decline
- 100% EAS Guaranteed
- Green Device Available

Applications

- Power management in half bridge and inverters
- DC-DC Converter
- Load Switch

General Description

The XR4606A is the highest performance trenchN-ch and P-ch MOSFETs with extreme high cell density , which provide excellent RDSON and gate charge for most of the synchronous buck converter applications .

The XR4606A meet the RoHS and Green Product requirement , 100% EAS guaranteedwith full function reliability approved.

Product Summary

BVDSS	RDSON	ID
30V	18mΩ	7A
-30V	36mΩ	-6A

SOP8 Pin Configurations

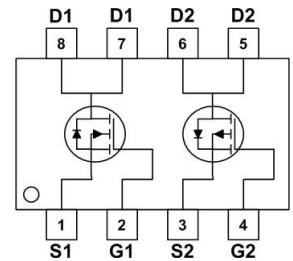
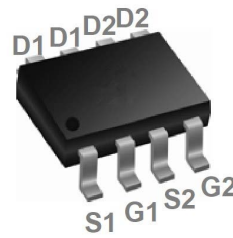

Absolute Maximum Ratings

Symbol	Parameter	Rating		Units
		N-Channel	P-Channel	
V_{DS}	Drain-Source Voltage	30	-30	V
V_{GS}	Gate-Source Voltage	± 20	± 20	V
$I_D@T_C=25^\circ C$	Continuous Drain Current, $V_{GS} @ 10V^1$	7.0	-6	A
$I_D@T_C=100^\circ C$	Continuous Drain Current, $V_{GS} @ 10V^1$	6	-4	A
I_{DM}	Pulsed Drain Current ²	20	-12	A
EAS	Single Pulse Avalanche Energy ³	72	59	mJ
I_{AS}	Avalanche Current	21	-19	A
$P_D@T_C=25^\circ C$	Total Power Dissipation ⁴	2.5	2.08	W
T_{STG}	Storage Temperature Range	-55 to 150	-55 to 150	$^\circ C$
T_J	Operating Junction Temperature Range	-55 to 150	-55 to 150	$^\circ C$

Thermal Data

Symbol	Parameter	Typ.	Max.	Unit
$R_{\theta JA}$	Thermal Resistance Junction-Ambient ¹	---	85	$^\circ C/W$
$R_{\theta JC}$	Thermal Resistance Junction-Case ¹	---	50	$^\circ C/W$

Electrical Characteristics (T_J=25 °C, unless otherwise noted)

Symbol	Parameter	Conditions	Min.	Typ.	Max.	Unit
BV _{DSS}	Drain-Source Breakdown Voltage	V _{GS} =0V, I _D =250uA	30	---	---	V
ΔBV _{DSS} /ΔT _J	BVDSS Temperature Coefficient	Reference to 25°C, I _D =1mA	---	0.034	---	V/°C
R _{DS(ON)}	Static Drain-Source On-Resistance ²	V _{GS} =10V, I _D =6A	---	18	25	mΩ
		V _{GS} =4.5V, I _D =5A	---	25	31	
V _{GS(th)}	Gate Threshold Voltage	V _{GS} =V _{DS} , I _D =250uA	1.0	1.5	2.5	V
ΔV _{GS(th)}	V _{GS(th)} Temperature Coefficient		---	-5.8	---	mV/°C
I _{DSS}	Drain-Source Leakage Current	V _{DS} =30V, V _{GS} =0V, T _J =25°C	---	---	1	uA
		V _{DS} =30V, V _{GS} =0V, T _J =55°C	---	---	5	
I _{GSS}	Gate-Source Leakage Current	V _{GS} =±20V, V _{DS} =0V	---	---	±100	nA
g _{fs}	Forward Transconductance	V _{DS} =15V, I _D =5A	---	10	---	S
R _g	Gate Resistance	V _{DS} =24V, V _{GS} =0V, f=1MHz	---	2.5	---	Ω
Q _g	Total Gate Charge (4.5V)	V _{DS} =20V, V _{GS} =4.5V, I _D =6A	---	7.2	---	nC
Q _{gs}	Gate-Source Charge		---	1.4	---	
Q _{gd}	Gate-Drain Charge		---	2.2	---	
T _{d(on)}	Turn-On Delay Time	V _{DD} =12V, V _{GS} =10V, R _G =3.3Ω I _D =5A	---	3.9	---	ns
T _r	Rise Time		---	9.2	---	
T _{d(off)}	Turn-Off Delay Time		---	14.5	---	
T _f	Fall Time		---	6.0	---	
C _{iss}	Input Capacitance	V _{DS} =25V, V _{GS} =0V, f=1MHz	---	370	---	pF
C _{oss}	Output Capacitance		---	54	---	
C _{rss}	Reverse Transfer Capacitance		---	40	---	

Guaranteed Avalanche Characteristics

Symbol	Parameter	Conditions	Min.	Typ.	Max.	Unit
EAS	Single Pulse Avalanche Energy ⁵	V _{DD} =25V, L=0.1mH, I _{AS} =10A	16	---	---	mJ

Diode Characteristics

Symbol	Parameter	Conditions	Min.	Typ.	Max.	Unit
I _S	Continuous Source Current ^{1,6}	V _G =V _D =0V, Force Current	---	---	7	A
I _{SM}	Pulsed Source Current ^{2,6}		---	---	20	A
V _{SD}	Diode Forward Voltage ²	V _{GS} =0V, I _S =5A, T _J =25°C	---	---	1.2	V

Note :

- 1.The data tested by surface mounted on a 1 inch² FR-4 board with 20Z copper, t<10sec.
- 2.The data tested by pulsed, pulse width ≤ 300us, duty cycle ≤ 2%
- 3.The EAS data shows Max. rating. The test condition is V_{DD}=25V, V_{GS}=10V, L=0.1mH, I_{AS}=10A
- 4.The power dissipation is limited by 150°C junction temperature
- 5.The Min. value is 100% EAS tested guarantee.
- 6.The data is theoretically the same as I_D and I_{DM}, in real applications, should be limited by total power dissipation.

Electrical Characteristics (T_J=25°C unless otherwise noted)

Parameter	Symbol	Conditions	Min.	Typ.	Max.	Unit
Static Characteristics						
Drain-Source Breakdown Voltage	V _{(BR)DSS}	V _{GS} = 0V, I _D = -250μA	-30	-	-	V
Zero Gate Voltage Drain Current	I _{DSS}	V _{DS} = -30V, V _{GS} = 0V	-	-	-1	μA
Gate-Source Leakage	I _{GSS}	V _{DS} = 0V, V _{GS} = ±20V	-	-	±100	nA
Gate-Source Threshold voltage	V _{GS(th)}	V _{DS} = V _{GS} , I _D = -250μA	-1	-1.5	-2.5	V
Drain-Source on-State Resistance ³	R _{DSON}	V _{GS} = -10V, I _D = -4.1A	-	36	60	mΩ
		V _{GS} = -4.5V, I _D = -3A	-	50	85	
Dynamic Characteristics⁴						
Input Capacitance	C _{iss}	V _{GS} = 0V , V _{DS} = -15V, f = 1.0MHz	-	530	-	pF
Output Capacitance	C _{oss}		-	70	-	
Reverse Transfer Capacitance	C _{rss}		-	56	-	
Switching Characteristics⁴						
Total Gate Charge	Q _g	V _{GS} = -10V, V _{DS} = -15V, I _D = -4.1A	-	6.8	-	nC
Gate-Source Charge	Q _{gs}		-	1.0	-	
Gate-Drain Charge	Q _{gd}		-	1.4	-	
Turn-on Delay Time	t _{d(on)}	V _{GS} = -10V, V _{DS} = -15V , R _L = 15Ω,R _{GEN} = 2.5Ω	-	14	-	ns
Rise Time	t _r		-	61	-	
Turn-off Delay time	t _{d(off)}		-	19	-	
Fall Time	t _f		-	10	-	
Source-Drain Body Diode Characteristics						
Diode Forward Voltage ³	V _{SD}	I _S = -4.1A, V _{GS} = 0V	-	-	-1.2	V
Continuous Source Current	I _S		-	-	-6.0	A

Notes:

1. Repetitive rating, pulse width limited by junction temperature T_{J(MAX)}=150°C.
2. The data tested by surface mounted on a 1 inch2 FR-4 board with 2OZ copper, The value in any given application depends on the user's specific board design.
3. Pulse Test: Pulse width≤300μs, duty cycle≤2%.
4. This value is guaranteed by design hence it is not included in the production test.

N-Channel Typical Characteristics

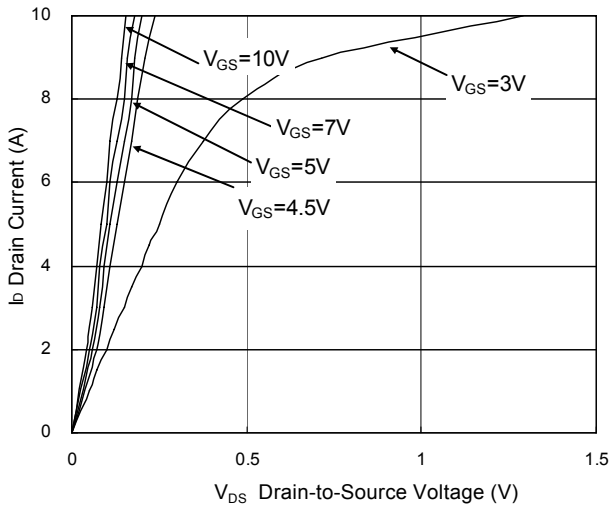

Fig.1 Typical Output Characteristics

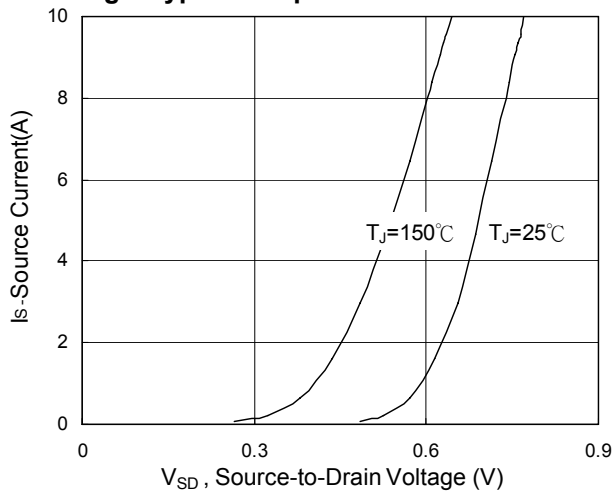
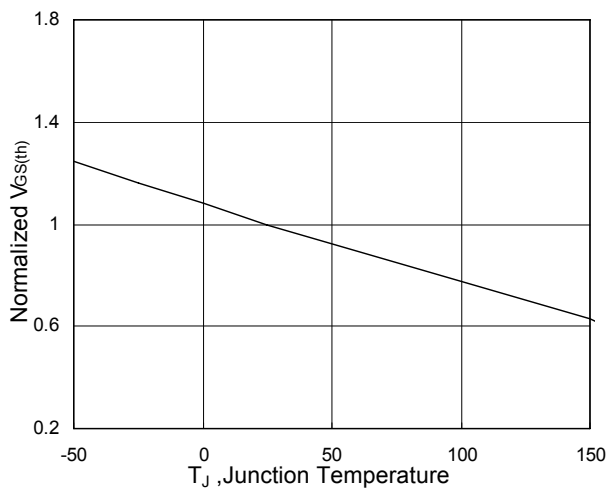

Fig.3 Forward Characteristics of Reverse



(°C) Fig.5 $V_{GS(th)}$ vs. T_J

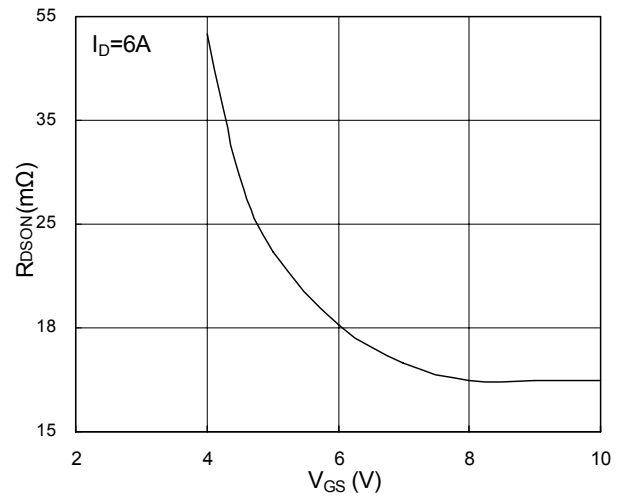

Fig.2 On-Resistance vs. G-S Voltage

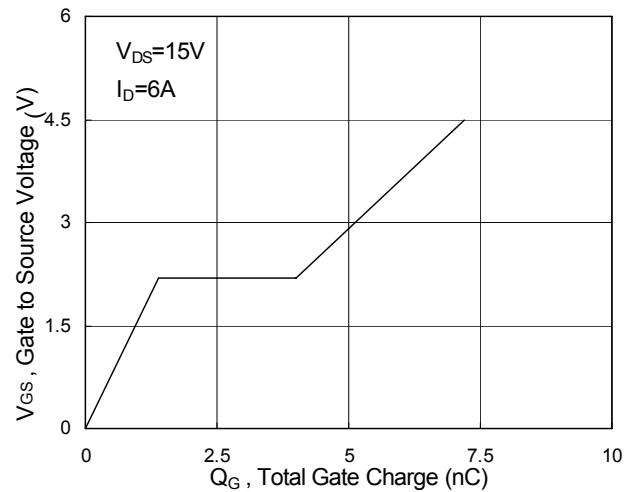

Fig.4 Gate-charge Characteristics

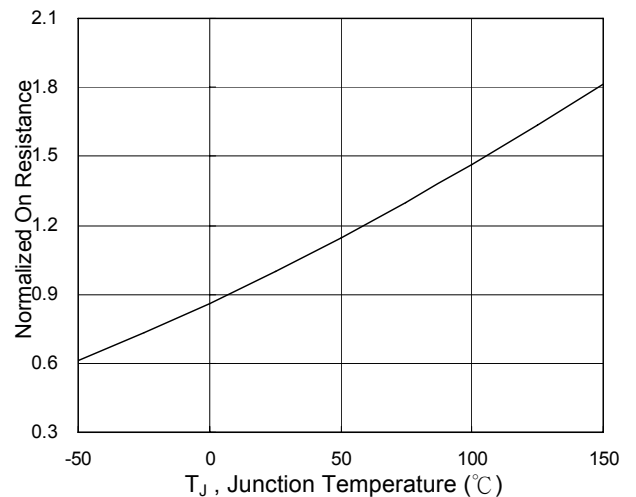

Fig.6 Normalized $R_{DS(on)}$ vs. T_J

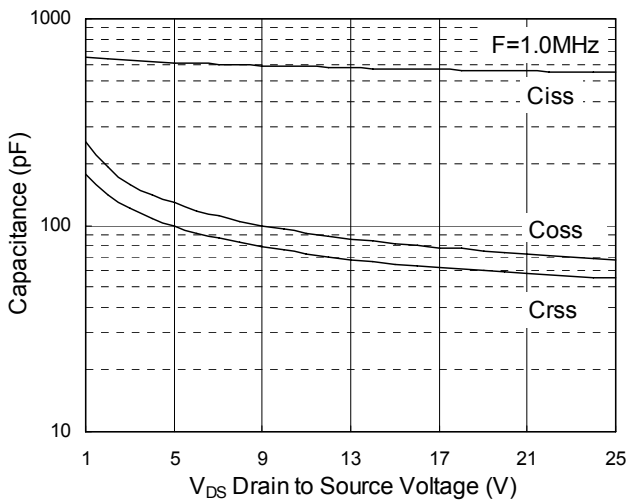

Fig.7 Capacitance

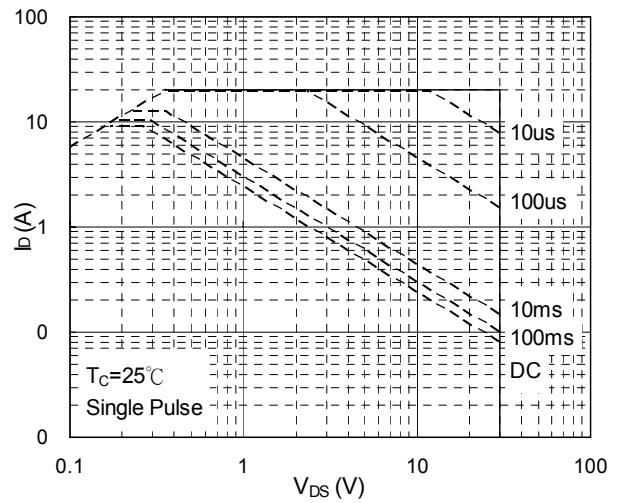

Fig.8 Safe Operating Area

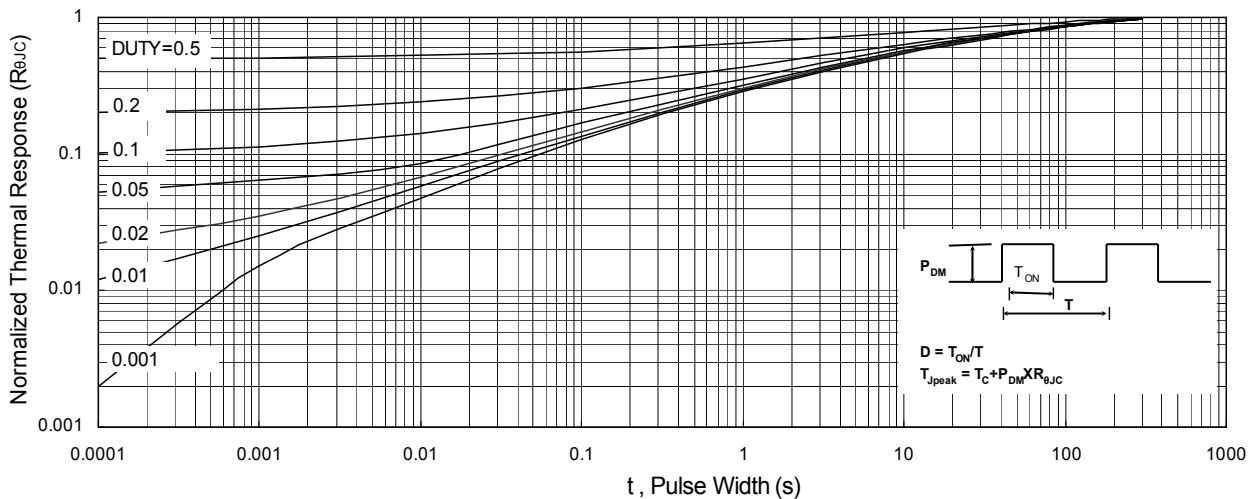

Fig.9 Normalized Maximum Transient Thermal Impedance

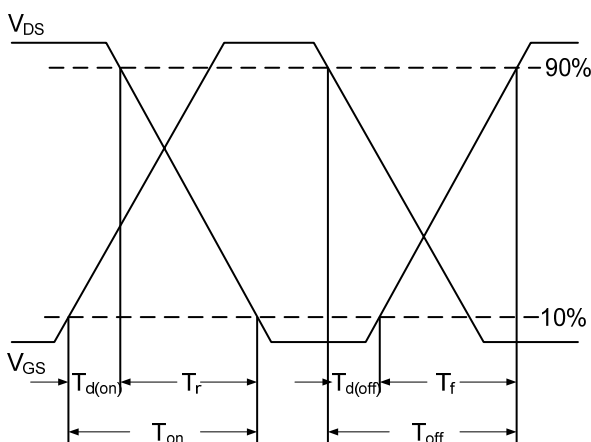

Fig.10 Switching Time Waveform

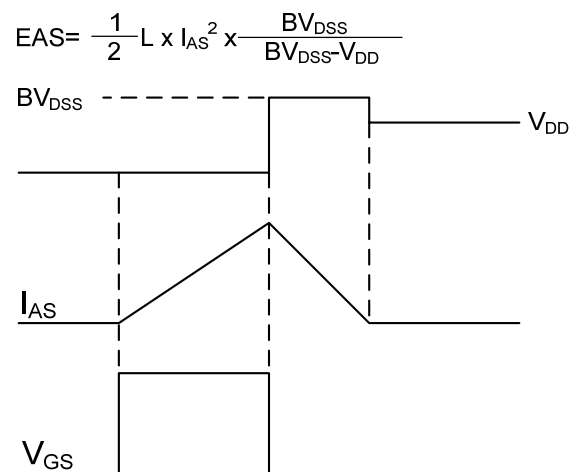

Fig.11 Unclamped Inductive Waveform

P-Channel Typical Characteristics

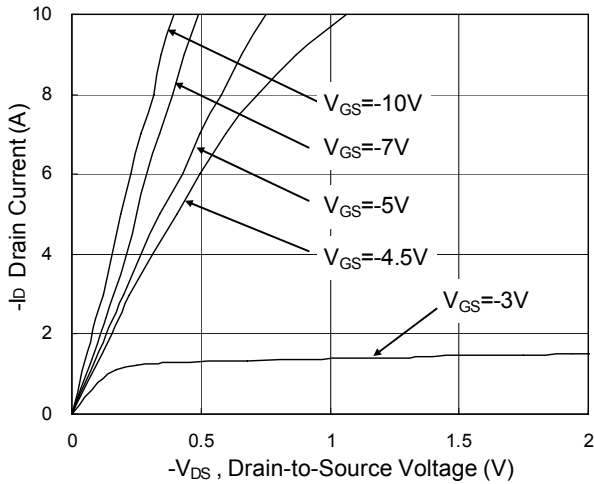

Fig.1 Typical Output Characteristics

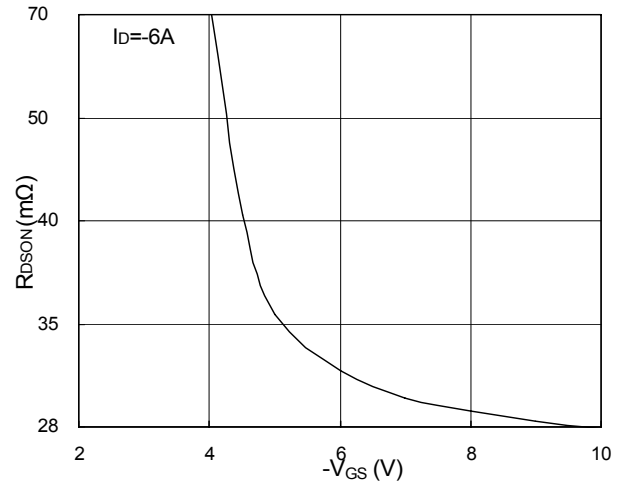

Fig.2 On-Resistance vs. Gate-Source

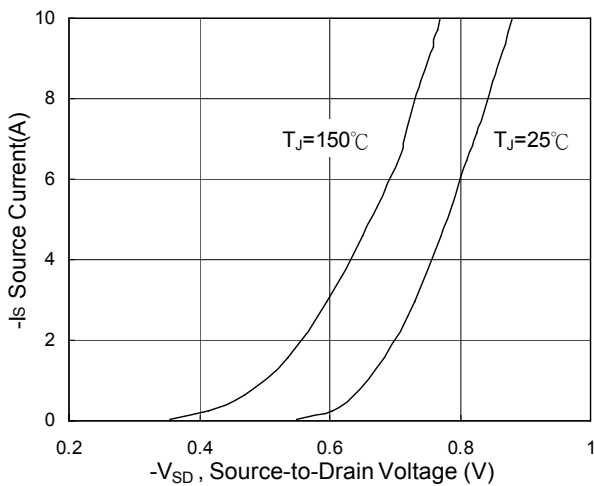
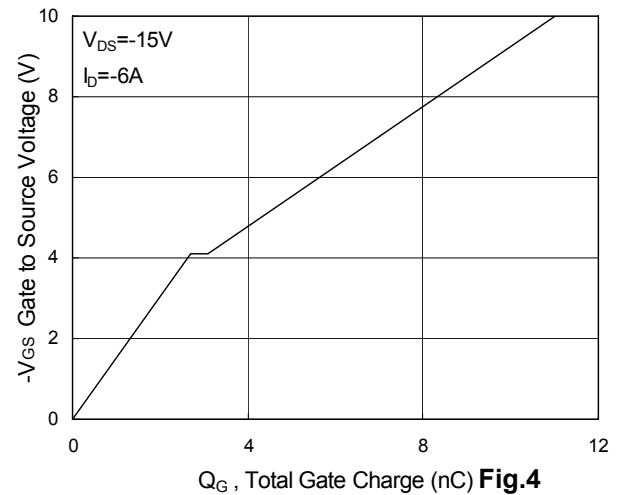

Fig.3 Forward Characteristics of Reverse



Gate-charge Characteristics

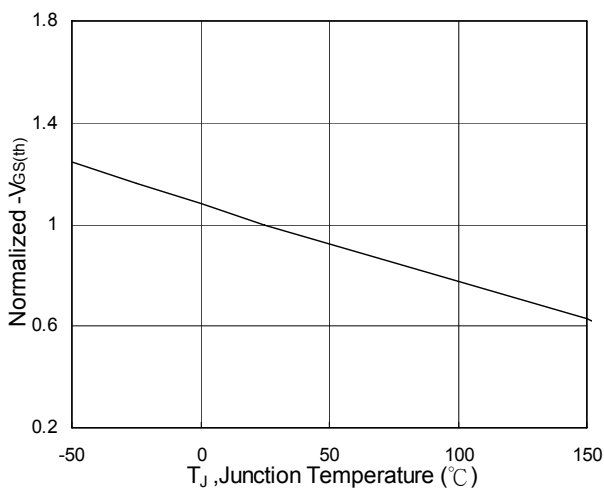

Fig.5 Normalized V_{GS(th)} vs. T_J

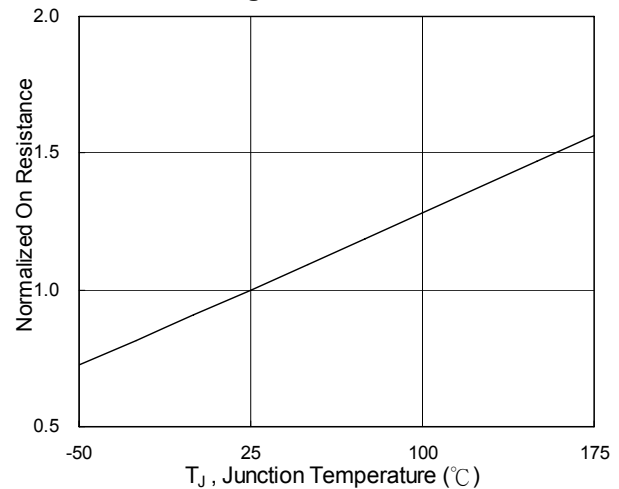

Fig.6 Normalized R_{DS(on)} vs. T_J

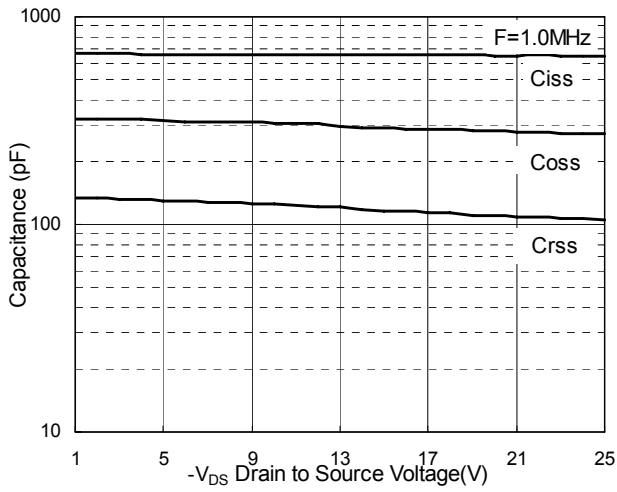

Fig.7 Capacitance

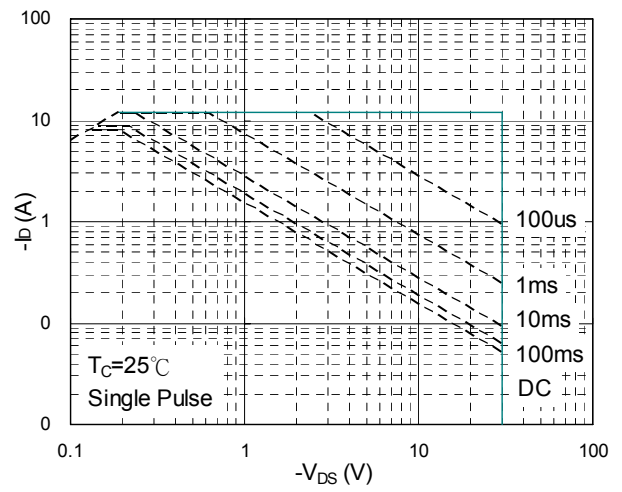

Fig.8 Safe Operating Area

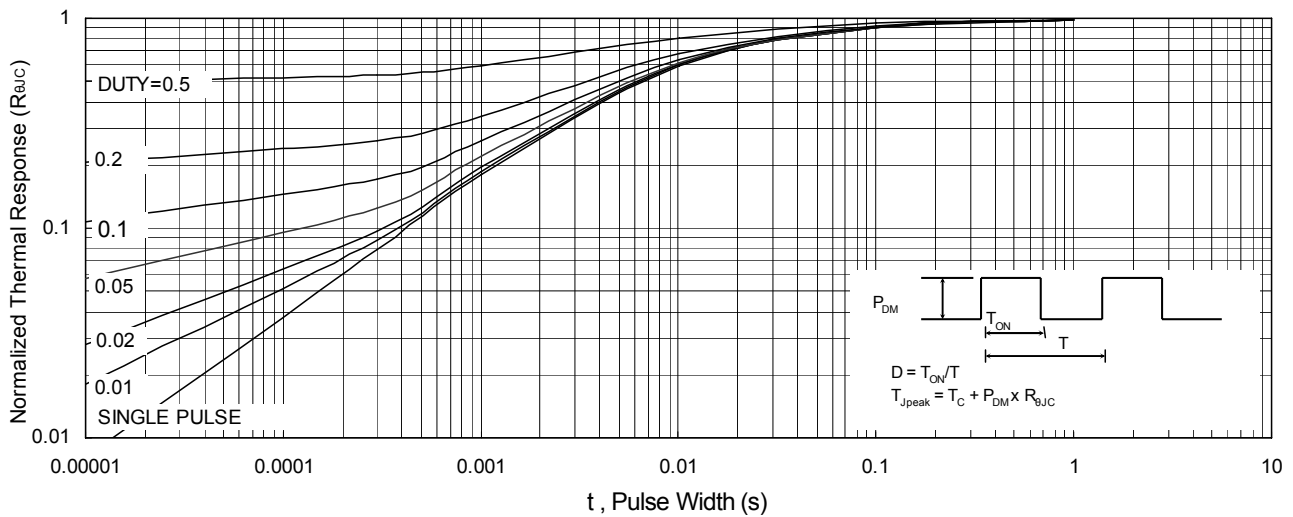

Fig.9 Normalized Maximum Transient Thermal Impedance

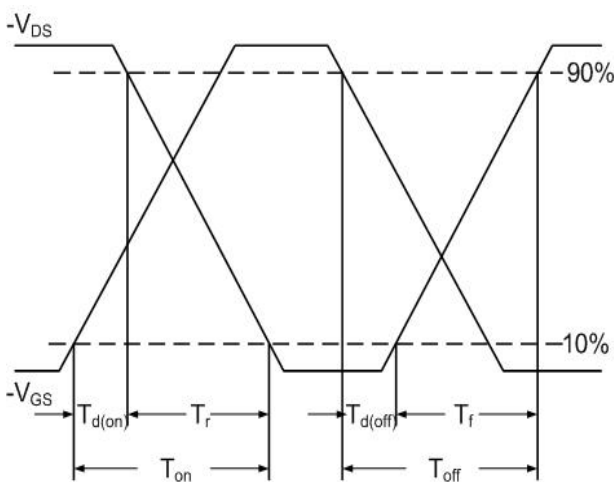

Fig.10 Switching Time Waveform

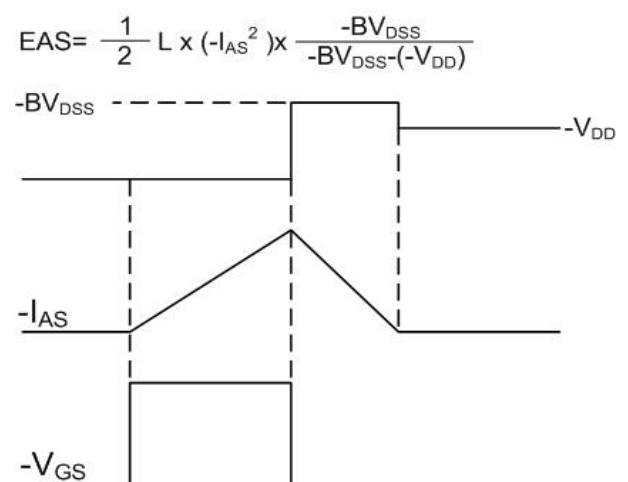
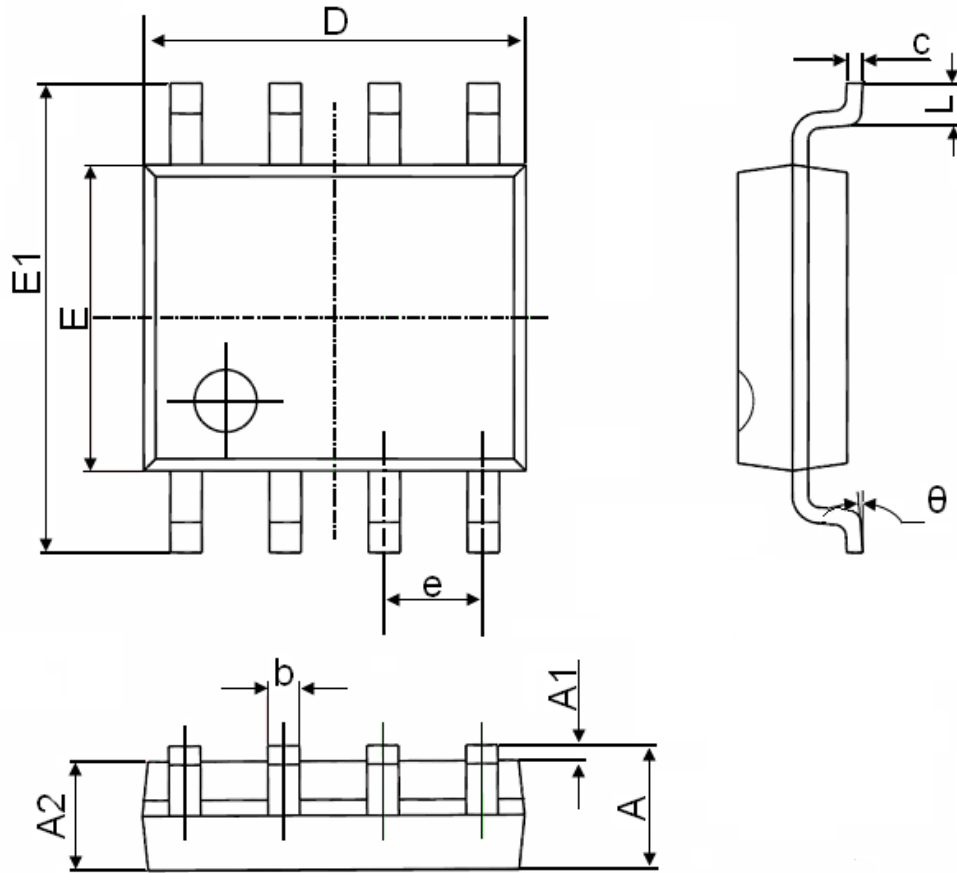

Fig.11 Unclamped Inductive Waveform

$$EAS = \frac{1}{2} L \times (-I_{AS}^2) \times \frac{-BV_{DSS}}{-BV_{DSS} - (-V_{DD})}$$

Package Mechanical Data- SOP-8



Symbol	Dimensions In Millimeters		Dimensions In Inches	
	Min.	Max.	Min.	Max.
A	1.350	1.750	0.053	0.069
A1	0.100	0.250	0.004	0.010
A2	1.350	1.550	0.053	0.061
b	0.330	0.510	0.013	0.020
c	0.170	0.250	0.006	0.010
D	4.700	5.100	0.185	0.200
E	3.800	4.000	0.150	0.157
E1	5.800	6.200	0.228	0.244
e	1.270(BSC)		0.050(BSC)	
L	0.400	1.270	0.016	0.050
θ	0°	8°	0°	8°