



The Future of Analog IC Technology®

MP26029

1A, Standalone, Linear, Li-Ion Battery Charger with Thermal Regulation

DESCRIPTION

The MP26029 is a highly integrated, single-cell Li-ion/Li-polymer battery charger IC with thermal regulation. The MP26029 is able to charge the battery by using either an AC adapter (up to 13V) or USB port. The MP26029 also features pre-charge, high-accuracy constant-current charge (CC, up to 1A) and constant-voltage (CV) regulation, charge termination, and auto-recharge.

The MP26029 has input voltage limit function. In case the CC current exceeds the current rating of input power, the MP26029 will decrease the charge current automatically once the input voltage reaches the input voltage limit.

The MP26029 has a NTC pin to monitor the battery temperature via a negative temperature coefficient (NTC) thermistor, once the battery temperature is out of cold/hot window the charging will be suspended.

The MP26029 also has One-time-program (OTP) function to program the parameters like battery full voltage, termination current, input voltage limit, input OVP threshold, thermal regulation threshold and so on.

The MP26029 is available in 6-pin SOT563, 8-pin SOIC8 EP, and 10-pin QFN (3mmx3mm) packages.

FEATURES

- Fully Autonomous Charger for Single-Cell Li-Ion/Polymer Batteries
- Programmable Charge Current: 30mA to 1A
- $\pm 0.5\%$ Charging Voltage Accuracy
- 13V Maximum Voltage for the Input Source
- Fully Integrated Power Switches and No External Blocking Diode Required
- Input Voltage Limit Regulation
- Built-In Robust Charging Protection, Including Battery Temperature Monitor and Safety Timer
- Thermal Limiting Regulation On-Chip
- Available in SOT563, SOIC8 EP, and QFN-10 (3mmx3mm) Packages

APPLICATIONS

- Smart Handheld Devices
- Digital Cameras, Bluetooth
- Toys

All MPS parts are lead-free, halogen-free, and adhere to the RoHS directive. For MPS green status, please visit the MPS website under Quality Assurance. "MPS" and "The Future of Analog IC Technology" are registered trademarks of Monolithic Power Systems, Inc.

TYPICAL APPLICATION

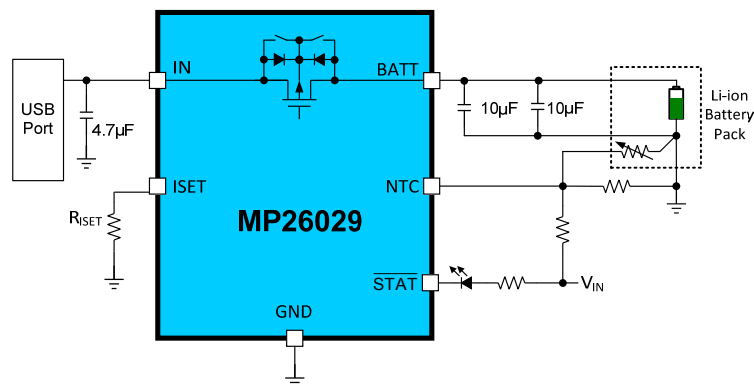

ORDERING INFORMATION

Part Number	Package	Top Marking
MP26029GTF-xxxx**	SOT563*	See Below
MP26029GQ-xxxx***	QFN-10 (3mmx3mm)	See Below
MP26029GN-xxxx****	SOIC8 EP*	See Below

* Check with the factory to ensure that the SOIC8 EP and SOT563 packages are in stock.

** For Tape & Real, add suffix -Z (e.g.: MP26029GTF-xxxx-Z)

*** For Tape & Real, add suffix -Z (e.g.: MP26029GQ-xxxx-Z)

**** For Tape & Real, add suffix -Z (e.g.: MP26029GN-xxxx-Z)

“xxxx” is the register setting option. The factory default is “0000.” This content can be viewed in the OTP map on page 14. Please contact an MPS FAE to obtain an “xxxx” value.

TOP MARKING (MP26029GTF & MP26029GQ)

AXJY

LLL

AXJ: Product code of MP26029GTF and MP26029GQ

Y: Year code

LLL: Lot number

TOP MARKING (MP26029GN)

MP26029

LLLLLLLL

MPSYWW

MP26029: Part number

LLLLLLLL: Lot number

MPS: MPS prefix

Y: Year code

WW: Week code

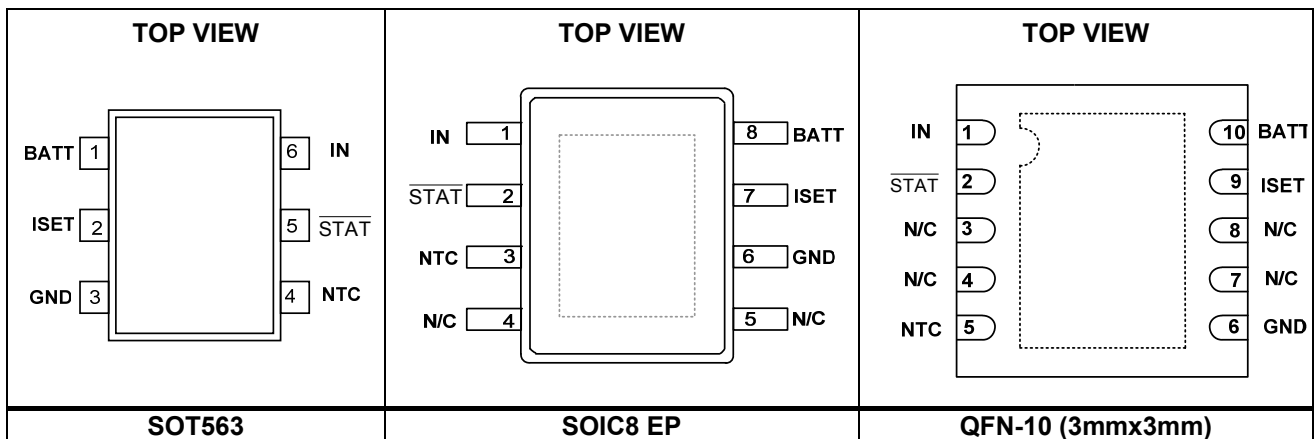
PACKAGE REFERENCE

PIN FUNCTIONS

SOT563 Pin #	SOIC8 Pin #	QFN-10 Pin #	Name	I/O	Description
1	8	10	BATT	Power	Battery positive terminal. Place a ceramic capacitor ($\geq 20\mu\text{F}$) between BATT and GND as close to the IC as possible.
2	7	9	ISET	I	CC charge current setting. Connecting an external resistor between ISET and GND to set the charging current in CC mode. Floating ISET pin will disable charging function.
3	6	6	GND	Power	Ground.
4	3	5	NTC	I	Temperature sense input. Connect a negative temperature coefficient thermistor to NTC. Program the hot and cold temperature window with a resistor divider from IN to NTC to GND. Charging is suspended when NTC is out of its range.
5	2	2	$\overline{\text{STAT}}$	O	Open-drain status indication. $\overline{\text{STAT}}$ is pull down to AGND during charging. $\overline{\text{STAT}}$ stays open-drain state when charging is completed. Need external pull-up voltage source to this pin to deliver logic high signal when it's in open-drain state.
6	1	1	IN	Power	Input power. Place a ceramic capacitor ($\geq 4.7\mu\text{F}$) from IN to GND as close to the IC as possible.
-	4, 5	3, 4, 7, 8	N/C		No connection.

ABSOLUTE MAXIMUM RATINGS ⁽¹⁾

IN, STAT to GND	-0.3V to +13V
ISET, NTC to GND.....	-0.3V to +5.0V
All other pins to GND	-0.3V to +6.0V
ESD Rating (HBM) ⁽²⁾	2kV
ESD Rating (CDM) ⁽³⁾	500V
Continuous power dissipation (T _A = +25°C) ⁽⁴⁾	
SOT563 (1.6x1.6)	0.96W
QFN-10 (3mmx3mm).....	2.5W
SOIC8 EP (4.9x6.0)	2.6W
Junction temperature	150°C
Lead temperature (solder)	260°C
Storage temperature	-65°C to +150°C

Recommended Operating Conditions ⁽⁵⁾

Supply voltage (V _{IN})..	4.35V to 5.5V (USB input)
I _{CC}	up to 1A
V _{BATT}	up to 4.5V
Operating junction temp. (T _J)....	-40°C to +125°C

Thermal Resistance ⁽⁶⁾

	θ_{JA}	θ_{JC}
SOT563 (1.6x1.6)	130	60 ... °C/W
QFN-10 (3x3)	50	12 ... °C/W
SOIC8 EP (4.9x6.0)	48	10 ... °C/W

NOTES:

- 1) Exceeding these ratings may damage the device.
- 2) Per ANSI/ESDA/JEDEC JS-001, all pins
- 3) Per JESD22-C101, all pins
- 4) The maximum allowable power dissipation is a function of the maximum junction temperature T_J (MAX), the junction-to-ambient thermal resistance θ_{JA} , and the ambient temperature T_A. The maximum allowable continuous power dissipation at any ambient temperature is calculated by P_D (MAX) = (T_J (MAX)-T_A)/ θ_{JA} . Exceeding the maximum allowable power dissipation produces an excessive die temperature, causing the regulator to go into thermal shutdown. Internal thermal shutdown circuitry protects the device from permanent damage.
- 5) The device is not guaranteed to function outside of its operating conditions.
- 6) Measured on JESD51-7, 4-layer PCB.

ELECTRICAL CHARACTERISTICS

$V_{IN} = 5.0V$, $V_{BATT} = 3.5V$, $T_A = +25^{\circ}C$, unless otherwise noted.

Parameter	Symbol	Condition	Min	Typ	Max	Units
Input Source and Battery Protection						
Input operation voltage	V_{IN}		4.05	5	6.05	V
Input over-voltage protection trigger threshold	V_{IN_OVLO}	V_{IN} rising	6.05	6.25	6.45	V
Input over-voltage protection recover threshold				405		mV
Input under-voltage lockout threshold	V_{IN_UVLO}	V_{IN} falling	3.6	3.75	3.9	V
Input under-voltage lockout threshold hysteresis				150		mV
Input minimum voltage regulation	V_{IN_MIN}			4.5		V
Input vs. battery voltage headroom threshold	V_{HDRM}	V_{IN} rising	100	125	150	mV
Input vs. battery voltage headroom hysteresis				75		mV
Battery Charger						
IN to BATT switch on resistance	R_{ON_BATT}	$V_{IN} = 5V$, $I_{CC} = 100mA$, SOT563		450		mΩ
		$V_{IN} = 5V$, $I_{CC} = 100mA$, SOIC8 EP		570		
		$V_{IN} = 5V$, $I_{CC} = 100mA$, QFN (3x3)		530		
Input quiescent current	I_{IN_Q}	$I_{CC} = 0A$, ISET pin is float		415		μA
Battery quiescent current	I_{BATT_Q}	$V_{IN} = 0V$, $V_{BATT} = 4.2V$			100	nA
Battery charge voltage regulation	V_{BATT_REG}	$T_A = 25^{\circ}C$	4.179	4.20	4.221	V
Fast charge current	I_{CC}	$V_{IN} = 5V$, $V_{BATT} = 3.8V$, $R_{ISET} = 80.6k\Omega$	20	30	40	mA
		$V_{IN} = 5V$, $V_{BATT} = 3.8V$, $R_{ISET} = 24.9k\Omega$	95	110	125	
		$V_{IN} = 5V$, $V_{BATT} = 3.8V$, $R_{ISET} = 19.02k\Omega$	125	145	165	
		$V_{IN} = 5V$, $V_{BATT} = 3.8V$, $R_{ISET} = 6.04k\Omega$	460	500	540	
		$V_{IN} = 5V$, $V_{BATT} = 3.8V$, $R_{ISET} = 4.58k\Omega$	630	675	720	
		$V_{IN} = 5V$, $V_{BATT} = 3.8V$, $R_{ISET} = 3.3k\Omega$	900	958	1016	
		$V_{IN} = 5V$, $V_{BATT} = 3.8V$, $R_{ISET} = 3k\Omega$	995	1055	1115	
Charge termination current threshold ⁽⁷⁾	I_{TERM}	$V_{IN} = 5V$, $V_{BATT} = 4.2V$		10		% I_{CC}
Termination current accuracy		$I_{TERM} = 100mA$	75	89	125	mA
		$I_{TERM} = 48mA$	36	42	60	
		$I_{TERM} = 10mA$	7	9.6	13	
		$I_{TERM} = 3mA$	1	2.7	5	

ELECTRICAL CHARACTERISTICS (continued)
 $V_{IN} = 5.0V$, $V_{BATT} = 3.5V$, $T_A = +25^{\circ}C$, unless otherwise noted.

Parameter	Symbol	Condition	Min	Typ	Max	Units
Pre-charge current ⁽⁷⁾	I_{PRE}	$V_{IN} = 5V$, $V_{BATT} = 2.0V$		10		% I_{CC}
Pre-charge current Accuracy		$I_{PRE} = 100mA$	70	89	110	mA
		$I_{PRE} = 10mA$	7	9.5	13	
		$I_{PRE} = 3mA$	1.6	2.8	4.0	
Pre-charge to fast charge threshold	V_{BATT_PRE}	V_{BATT} rising		3.0		V
Pre-charge to fast charge threshold hysteresis				250		mV
Auto-recharge battery voltage threshold	V_{RECH}			200		mV
Safety timer for charging cycle	t_{TMR}	$t_{TMR} = 7$ hours	6.25	7	7.75	hours
Safety timer for pre-charging cycle			0.75	0.875	1	hours
Junction temperature regulation	T_{J_REG}	Thermal limit = $120^{\circ}C$		120		$^{\circ}C$
Thermal shutdown threshold ⁽⁷⁾	T_{J_SHDN}			150		$^{\circ}C$
Thermal shutdown hysteresis ⁽⁷⁾				20		$^{\circ}C$
NTC output current	I_{NTC}	Charge disabled	-100	0	100	nA
NTC cold temp rising threshold	V_{COLD}	As a percentage of V_{IN}	59.5%	61.5%	63.5%	
NTC cold temp rising threshold hysteresis		$V_{IN} = 5V$		90		mV
NTC hot temp falling threshold	V_{HOT}	As a percentage of V_{IN}	26.5%	28.5%	30.5%	
NTC hot temp falling threshold hysteresis		$V_{IN} = 5V$		90		mV

NOTE:

7) Guaranteed by design.

TYPICAL PERFORMANCE CHARACTERISTICS

$V_{IN} = 5V$, $T_A = 25^\circ C$, QFN (3x3) package, unless otherwise noted.

Pre-Charge Current vs. Temperature

$R_{ISET} = 3k\Omega$

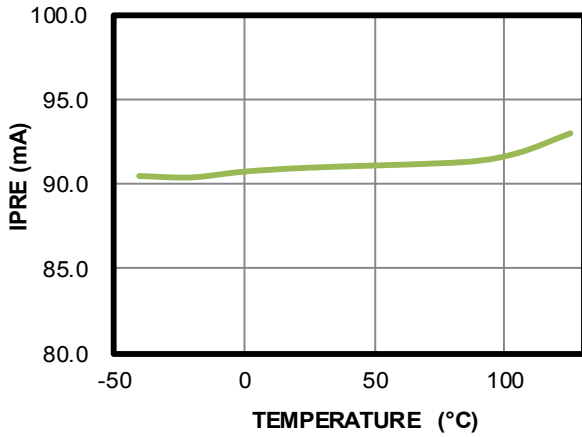

Fast-Charge Current vs. Temperature

$R_{ISET} = 3k\Omega$

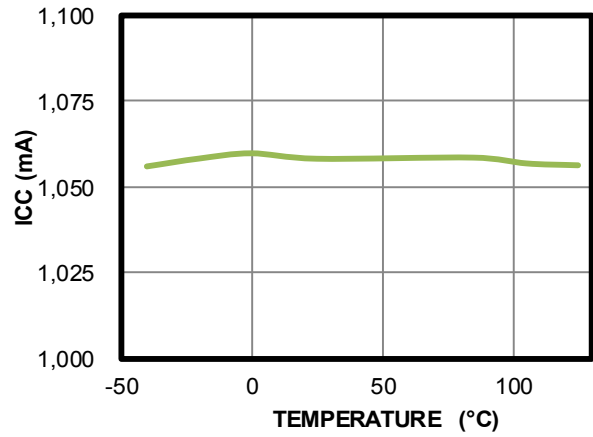

Charge Termination Current vs. Temperature

$R_{ISET} = 3k\Omega$

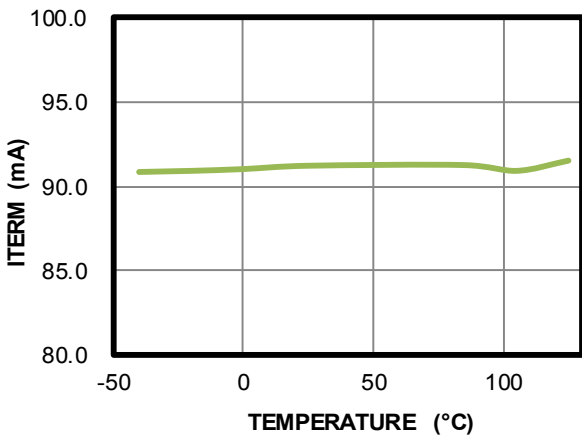

Battery-Charge Voltage Regulation vs. Temperature

$V_{BATT_REG} = 4.2V$

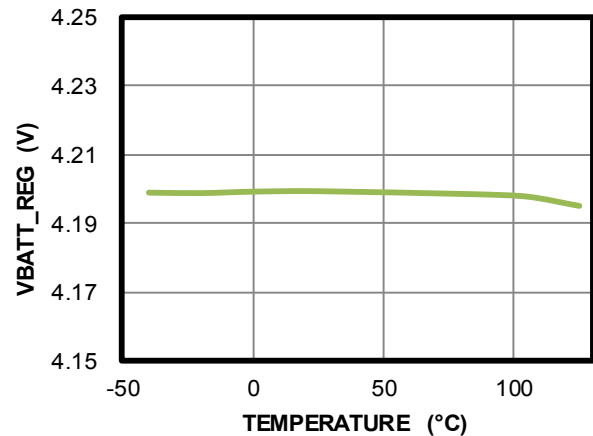

Input Minimum Voltage vs. Temperature

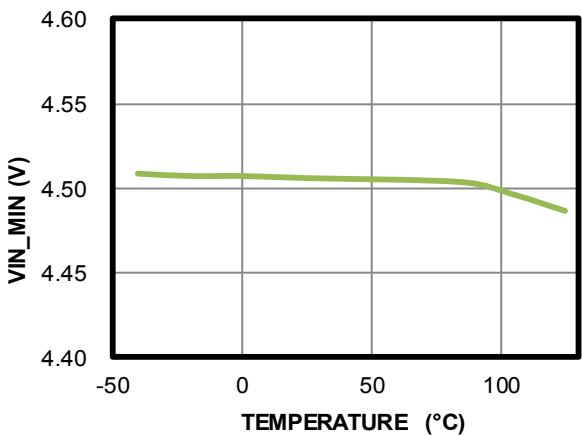

Battery Leakage Current vs. Temperature

$V_{BATT} = 4.2V$

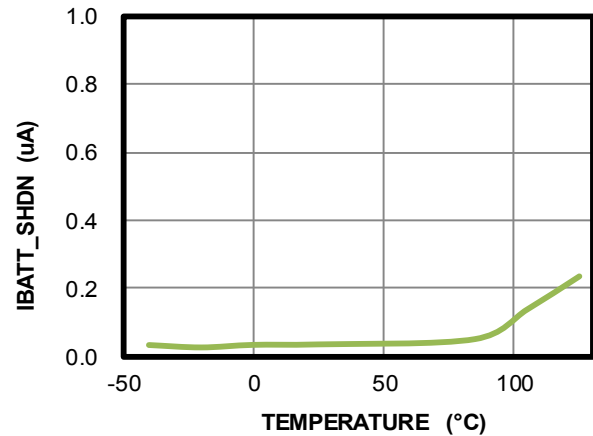

TYPICAL PERFORMANCE CHARACTERISTICS (continued)
 $V_{IN} = 5V$, $T_A = 25^\circ C$, QFN (3x3) package, unless otherwise noted.

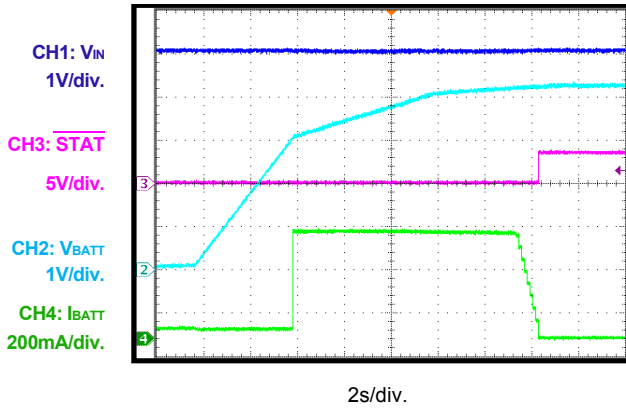
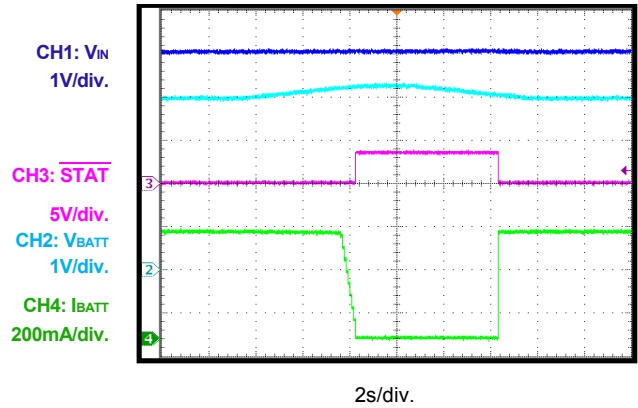
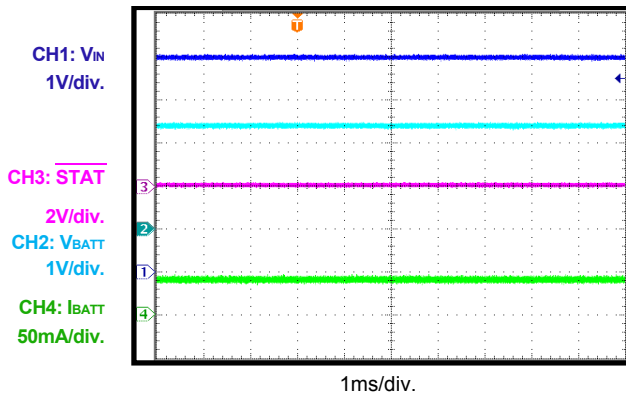
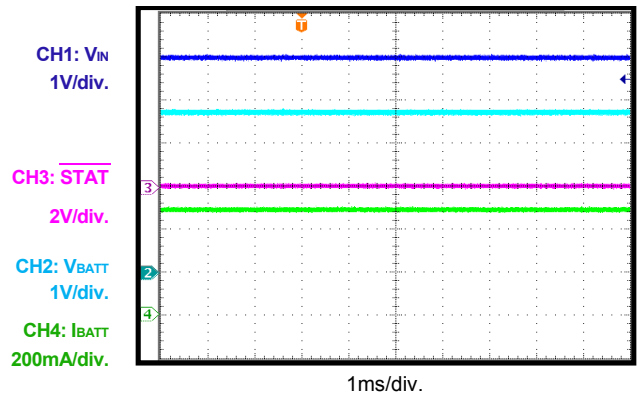
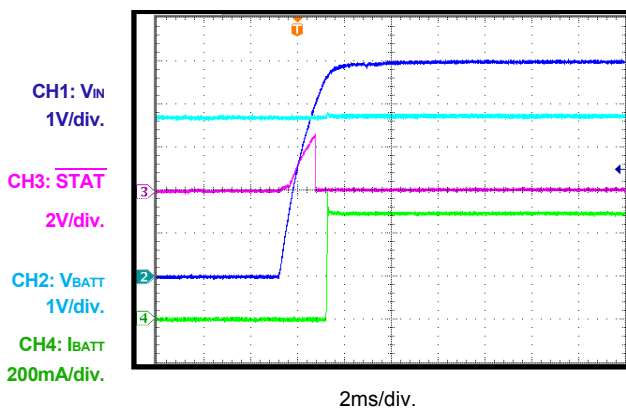
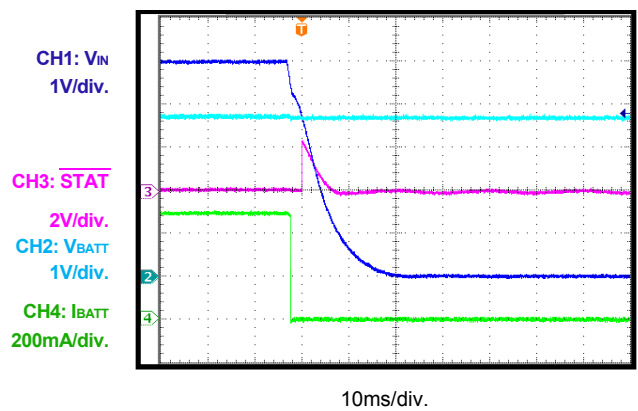
Battery-Charge Curve

Auto-Recharge

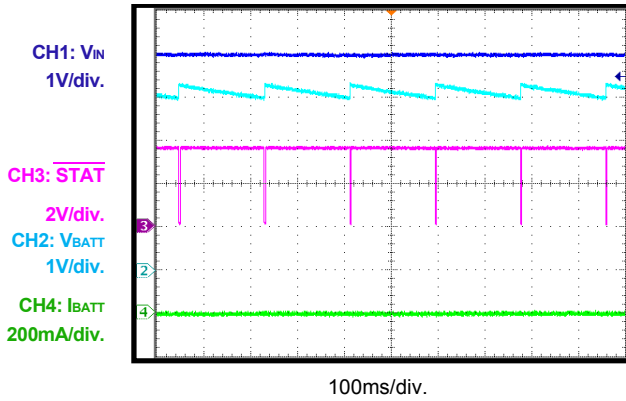
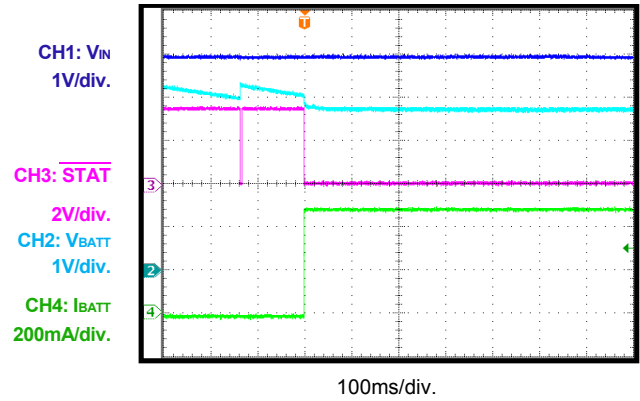
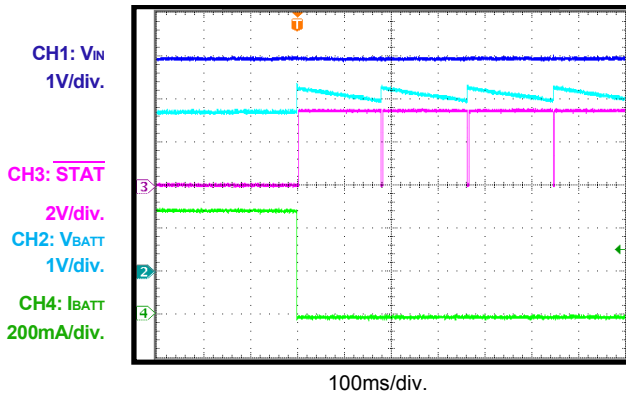
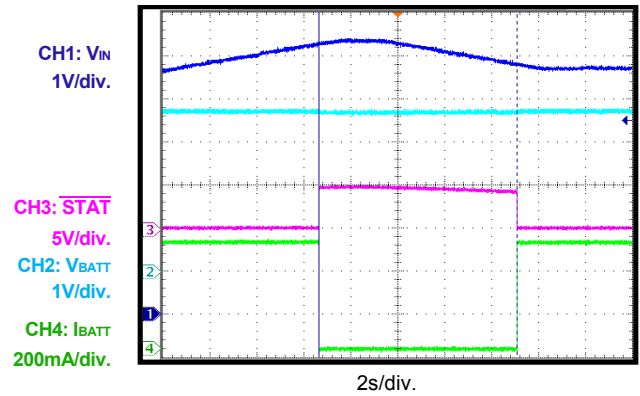
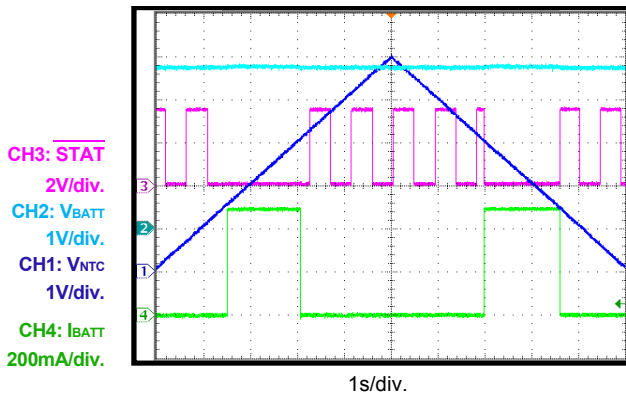
Pre-Charge Steady State
 $V_{BATT} = 2.4V$, $I_{PRE} = 50mA$

CC Steady State
 $V_{BATT} = 3.7V$

Power On
 $V_{BATT} = 3.7V$

Power Off
 $V_{BATT} = 3.7V$

TYPICAL PERFORMANCE CHARACTERISTICS (continued)
 $V_{IN} = 5V$, $T_A = 25^\circ C$, QFN (3x3) package, unless otherwise noted.

BATT Float Operation

BATT Insertion
 $V_{BATT} = 3.7V$

BATT Removal
 $V_{BATT} = 3.7V$

VIN OVP

NTC Protection
 $V_{BATT} = 3.7V$

BLOCK DIAGRAM

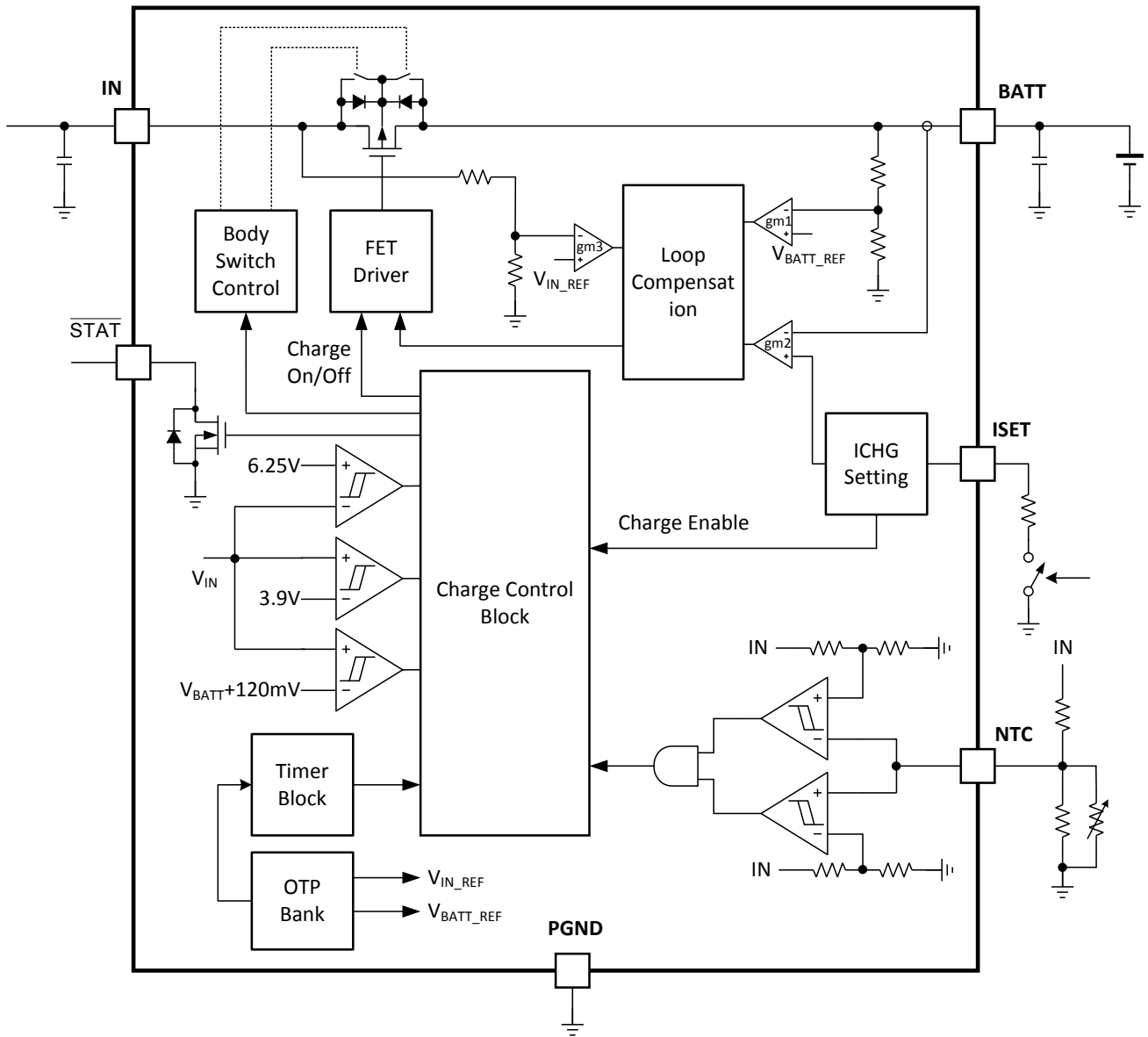

Figure 1: Functional Block Diagram

OPERATION

The MP26029 is a single-cell, Li-ion or Li-polymer battery charger with thermal regulation. The full-function charger features pre-charge (PRE), fast constant-current (CC) and constant-voltage (CV) regulation, charge termination, auto-recharge, and a built-in safety timer.

The IC integrates a charging MOSFET between IN and BATT. See R_{ON_BATT} in the EC table on page 5.

During charging mode, the on-chip charging MOSFET works as a full-featured linear charger with pre-charge, high-accuracy fast constant-current and constant-voltage charge, charge termination, auto-recharge, NTC monitor, safety timer control, and thermal protection. The charge current can be programmed via ISET. The IC limits the charge current when the die temperature exceeds the thermal regulation threshold (120°C).

Power Supply

The internal bias circuit of the IC is powered from the higher voltage of either IN or BATT. When IN or BATT rises above the respective under-voltage lockout (UVLO) threshold, the battery depletion comparator and the charging MOSFET driver are active.

Input Over-Voltage Protection (OVP)

The MP26029 has an input over-voltage protection (OVP) with 6.25V threshold (programmable via OTP). If the input voltage exits the normal input voltage range, the charging MOSFET is turned off immediately.

Battery Charge Profile

The IC provides three main charging phases: pre-charge, fast constant-current charge and constant-voltage charge (see Figure 2).

1. **Phase 1 (pre-charge):** The IC is able to safely pre-charge the deeply depleted battery until the battery voltage reaches the pre-charge to fast-charge threshold (V_{BATT_PRE}). If V_{BATT_PRE} is not reached before the pre-charge timer (1hr) expires, the charge cycle is stopped, and a corresponding timeout fault signal is asserted.
2. **Phase 2 (constant-current charge):** When the battery voltage exceeds V_{BATT_PRE} , the IC enters a fast constant-current charge (fast-charge) phase. The fast charge current is programmed via ISET and can be calculated with Equation (1):

$$I_{CC}(\text{mA}) = 3200 \times R_{ISET}(\text{k}\Omega)^{-1.05} \quad (1)$$

The charge current can be set from 30mA to 1A for various applications. Floating ISET can disable the charge function.
3. **Phase 3 (constant-voltage charge):** When the battery voltage rises to the battery regulation voltage (V_{BATT_REG}), the charge mode changes from CC mode to CV mode, and the charge current begins to taper off.

The charge cycle is considered completed when the battery voltage is above the recharge threshold (V_{RECH}), and the charge current reaches the battery charge termination current threshold (I_{TERM}). If I_{TERM} is not reached before the safety charge timer expires, the charge cycle stops, and a corresponding timeout fault signal is asserted. See the Safety Timer section on page 13.

The battery charge termination current threshold (I_{TERM}) is 10% I_{CC} .

During the entire charging process, the actual charge current may be less than the resistor setting due to the thermal regulation, which reduces the charge current so that the IC junction temperature does not exceed the preset limit.

The following conditions can start a new charge cycle:

 - The input power is recycled.
 - Auto-recharge kicks in.
 - No thermistor fault at NTC.
 - No safety timer fault.
 - No battery over-voltage.

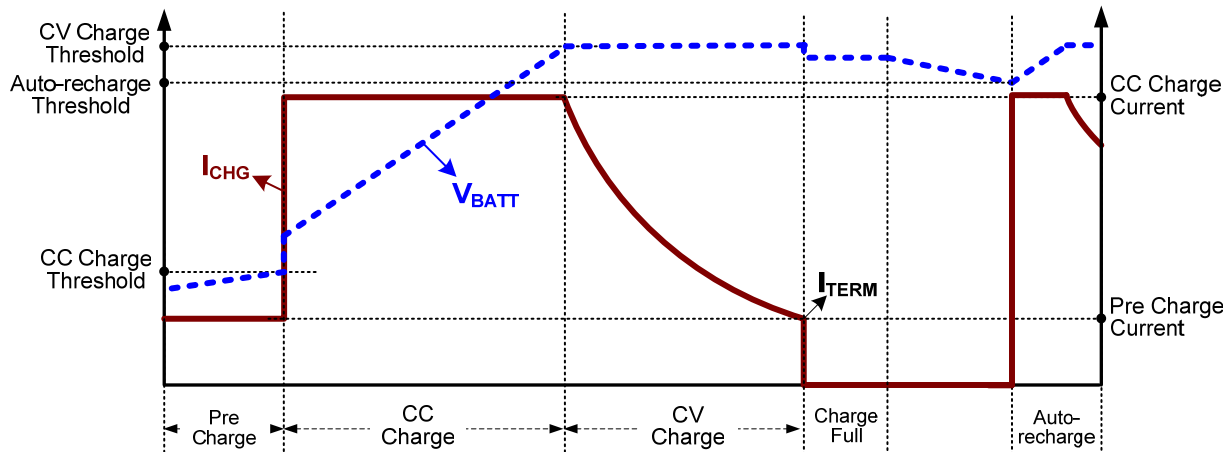
Figure 2: Battery Charge Profile

Automatic Recharge

When the battery is fully charged and charging is terminated, the battery may be discharged due to the system consumption or a self-discharge. When the battery voltage is discharged below the recharge threshold, the IC begins another new charging cycle automatically without having to restart a charging cycle manually.

Battery Over-Voltage Protection (OVP)

The IC is designed with a built-in battery over-voltage limit about 150mV higher than V_{BATT_REG} . When a battery over-voltage event occurs, the IC suspends the charging immediately and asserts a fault indication at \overline{STAT} pin.

Floating Charging Voltage

The floating voltage for the constant voltage regulation phase is V_{BATT_REG} . When $V_{BATT_REG} = 4.2V$, it has a $\pm 0.5\%$ accuracy over the ambient temperature range of $0^{\circ}C$ to $+50^{\circ}C$. When the battery is removed, the BATT voltage is between $V_{BATT_REG} - V_{RECH}$ and V_{BATT_REG} .

Input Voltage Limit Regulation

If the input power source is not sufficient for supporting the charge current, the input voltage decreases. As the input voltage reaches the input voltage limit threshold, the charge current is reduced to prevent the input voltage from dropping further.

Thermal Regulation and Thermal Shutdown

The IC monitors the internal junction temperature continuously to maximize power delivery and prevent the chip from overheating. When the internal junction temperature reaches the preset limit of T_{J_REG} ($120^{\circ}C$), the IC reduces the charge current to prevent higher power dissipation.

When the junction temperature reaches $150^{\circ}C$, the charging MOSFET is turned off.

Negative Temperature Coefficient (NTC) Temperature Sensor

The MP26029 continuously monitors battery's temperature by measuring the voltage at the NTC pin, typically determined by a negative temperature coefficient (NTC) thermistor and external voltage dividers, as shown in Figure 3. Both the external voltage divider and the internal reference voltage divider are pulled up to the same power pin. So actually, the voltage ratios between the internal and external dividers are compared. For the NTC thermistor, the hotter ambient temperature, the lower resistance is, which corresponds to a lower voltage ratio, vice versa.

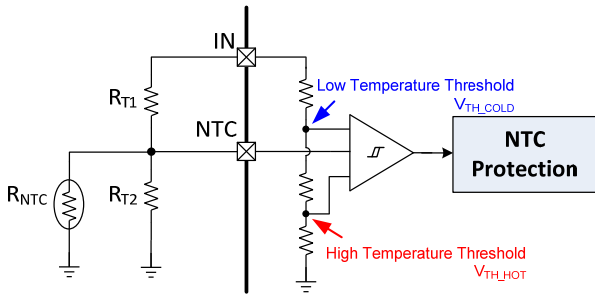

Figure 3: NTC Protection Circuit

$$V_{COLD} = \frac{V_{TH_COLD}}{V_{IN}} = \frac{R_{T2} // R_{NTC_COLD}}{R_{T1} + R_{T2} // R_{NTC_COLD}} \quad (2)$$

$$V_{HOT} = \frac{V_{TH_HOT}}{V_{IN}} = \frac{R_{T2} // R_{NTC_HOT}}{R_{T1} + R_{T2} // R_{NTC_HOT}} \quad (3)$$

Once the external voltage ratio exits the high temperature threshold (V_{HOT}) to low temperature threshold (V_{COLD}) range, it means the battery temperature is out of the COLD to HOT range, the IC suspends charging and reports the NTC fault. Charging resumes automatically after the battery temperature is within the COLD to HOT temperature range again. Figure 4 shows the standard control.

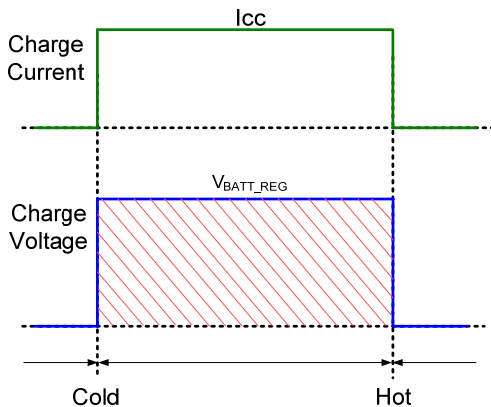

Figure 4: Standard NTC Window

Safety Timer

The IC provides both a pre-charge and a fast-charge safety timer to prevent an extended charging cycle due to abnormal battery conditions. The pre-charge safety timer is one hour when the battery voltage is lower than V_{BATT_PRE} . The fast-charge safety timer (seven hours) begins when the battery enters fast charging.

The safety timer is reset at the beginning of a new charging cycle.

Charge Enable Control

The MP26029 can reuse ISET pin to disable or enable charging by floating ISET pin or not. A recommended circuit is shown in Figure 5. Logic high will enable the charging and logic low will disable the charging.

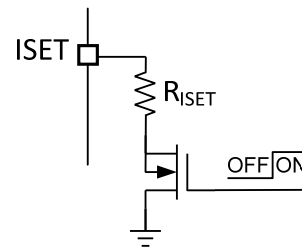

Figure 5: ISET Logic Control

Status Indication (\overline{STAT})

The IC has a hardware status output pin (\overline{STAT}). The status of \overline{STAT} in different cases is shown in Table 1.

Table 1: Operation Indications

Charging State	\overline{STAT}
In charging	Low
Charging complete	High
Charging suspended, fault	Blinking at 1Hz

OTP MAP

Bit	Symbol	Description	Default
Charge Termination Current Threshold			
Bit 13	$I_{TERM}^{(8)}$	0: 5% of I_{CC} 1: 10% of I_{CC}	1 (10% of I_{CC})
Termination Setting (termination control is allowed or not)			
Bit 12	$EN_{I_{TERM}}$	0: enabled 1: disabled	0 (enabled)
Input Minimum Voltage Regulation			
Bit 11	$V_{IN_MIN} [1]$	00: disabled 01: 4.75V	10 (4.5V)
Bit 10	$V_{IN_MIN} [0]$	10: 4.5V 11: 4.25V	
Junction Temperature Regulation Threshold			
Bit 9	$T_{J_REG} [1]$	00: 60°C 01: 80°C	11 (120°C)
Bit 8	$T_{J_REG} [0]$	10: 100°C 11: 120°C	
Battery Charge Voltage Regulation			
Bit 7	$V_{BATT_REG} [2]$	001: 3.6V 010: 3.8V 011: 4.1V	000 (4.2V)
Bit 6	$V_{BATT_REG} [1]$	000/111: 4.2V 100: 4.3V 101: 4.35V	
Bit 5	$V_{BATT_REG} [0]$	110: 4.4V	
Pre-Charge to Fast-Charge Threshold			
Bit 4	V_{BATT_PRE}	0: 2.8V 1: 3.0V	1 (3.0V)
Auto-Recharge Battery Voltage Threshold (below V_{BATT_REG})			
Bit 3	V_{RECH}	0: 100mV 1: 200mV	1 (200mV)
Safety Timer for Charging Cycle			
Bit 2	$CHG_TMR [1]$	00: disabled 01: 4.5 hrs	10 (7 hrs)
Bit 1	$CHG_TMR [0]$	10: 7 hrs 11: 10.5 hrs	
Input Over-Voltage Protection Trigger Threshold			
Bit 0	V_{IN_OVLO}	0: 6.25V 1: 10.6V	0 (6.25V)

NOTE:

8) I_{TERM} is recommended to be 10% when I_{CC} is set lower than 60mA.

CONTROL FLOW CHART

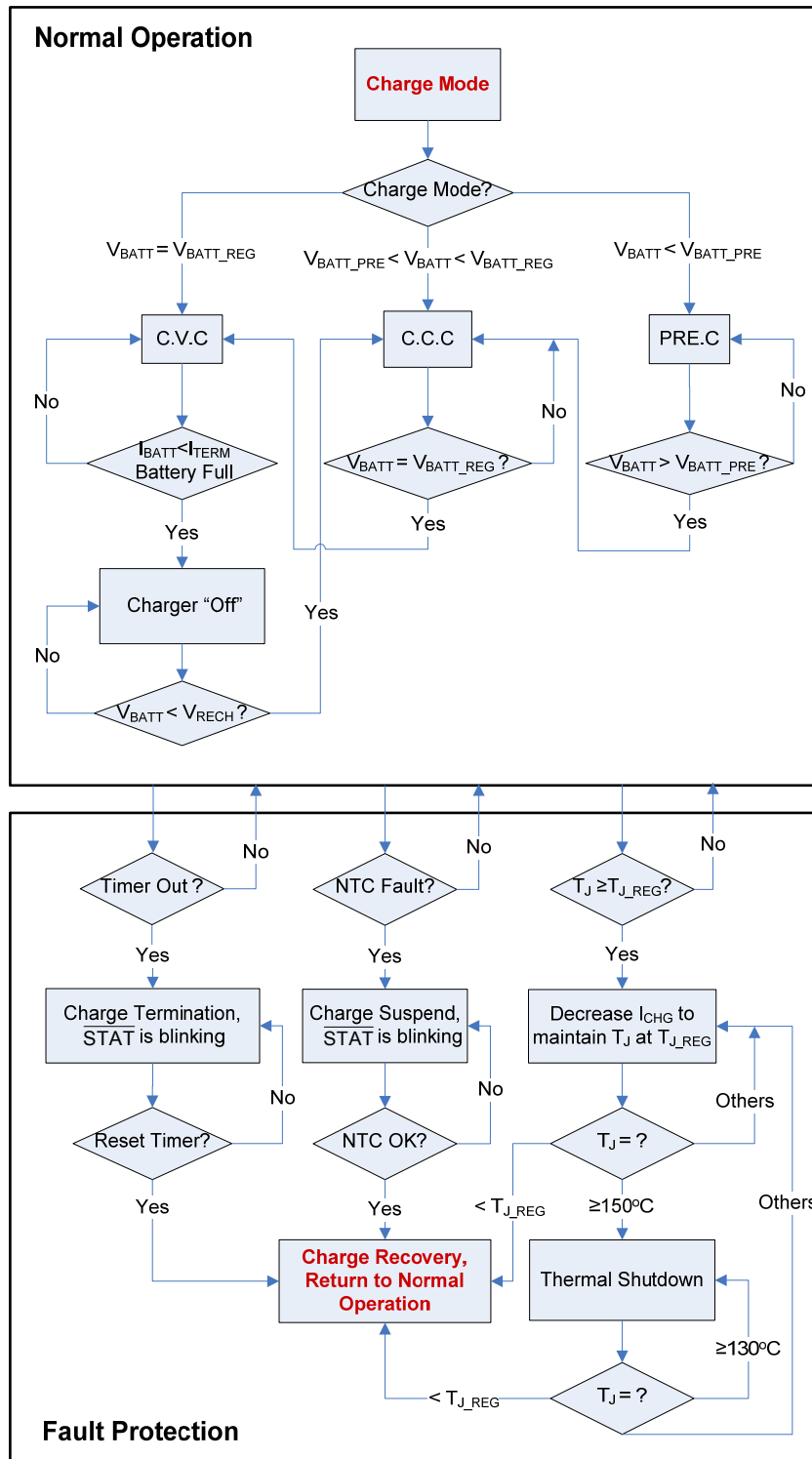

Figure 6: Charging Process

APPLICATION INFORMATION

Setting the Charge Current

A resistor (R_{ISET}) connected from ISET to GND sets the charge current (I_{CC}). The relationship between the charge current and setting resistor is established in Figure 7.

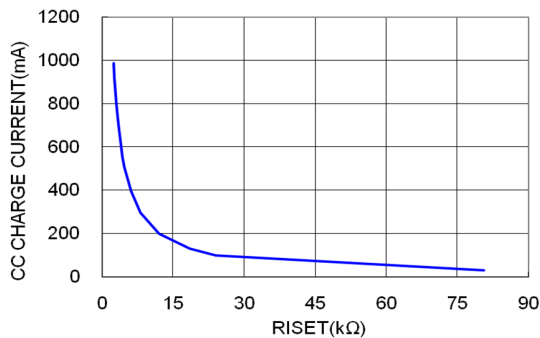

Figure 7: Charge Current vs. R_{ISET} Resistance

For example, if the typical I_{CC} is 1A, then R_{ISET} is calculated as 3.01kΩ. The tolerance of the I_{CC} setting is $\pm 10\%$. If a minimum or maximum charge current is required, first the typical value should be calculated according to the tolerance. Afterward, calculate the resistor according to Equation (1). Table 2 shows the calculated charging current with different resistances.

Table 2: R_{ISET} (1%) and I_{CC} Relationship

R_{ISET} (kΩ)	I_{CC} (mA)
3.01	1006
3.32	908
3.74	801
4.22	706
4.87	607
5.76	509
7.15	406
9.53	300
11.3	251
18.7	148
26.7	102
84.5	30

Selecting the NTC Resistor

As shown in Figure 3, the low temperature threshold (V_{COLD}) and high temperature threshold (V_{HOT}) are preset by the internal voltage divider reference circuit.

For a given NTC thermistor, according to Equation (2) and (3), and the required battery temperature range, the value R_{T1} and R_{T2} can be

determined by using the following equations (4) and (5):

$$R_{T1} = \frac{R_{NTC_HOT} \times R_{NTC_COLD} \times (V_{COLD} - V_{HOT})}{V_{COLD} \times V_{HOT} \times (R_{NTC_COLD} - R_{NTC_HOT})} \quad (4)$$

$$R_{T2} = \frac{R_{NTC_HOT} \times R_{NTC_COLD} \times (V_{COLD} - V_{HOT})}{R_{NTC_COLD} \times V_{HOT} \times (1 - V_{COLD}) - R_{NTC_HOT} \times V_{COLD} \times (1 - V_{HOT})} \quad (5)$$

R_{NTC_HOT} is the value of the NTC resistor at high temperature of the required temperature operation range, and R_{NTC_COLD} is the value of the NTC resistor at low temperature.

The two resistors, R_{T1} and R_{T2} , allow the high temperature limit and low temperature limit to be programmed independently. With this feature, the MP26029 can fit most type of NTC resistor and different temperature operation range requirements.

For example, for the 103AT thermistor, it has the following electrical characteristic:

At 0°C, $R_{NTC_COLD} = 27.28k\Omega$;

At 50°C, $R_{NTC_HOT} = 4.16k\Omega$.

According to the above equations (4) and (5), V_{HOT} and V_{COLD} from the EC table to calculate $R_{T1}=9.24k\Omega$ and $R_{T2}=32.17k\Omega$.

Selecting the Input Capacitor

An input capacitor is required for stability. Connect a minimum 4.7μF capacitor between IN and GND for stable operation. There can be more output capacitance than input as long as the input is at least 4.7μF.

Selecting the BATT to GND Capacitor

A capacitor from BATT to GND is also necessary in the MP26029. A >20μF ceramic capacitor (dielectric types X5R or X7R) is suitable for the MP26029 application circuit.

PCB Layout Guidelines

Place the external capacitors as close to the IC as possible to ensure the smallest input inductance and the ground impedance.

TYPICAL APPLICATION CIRCUIT

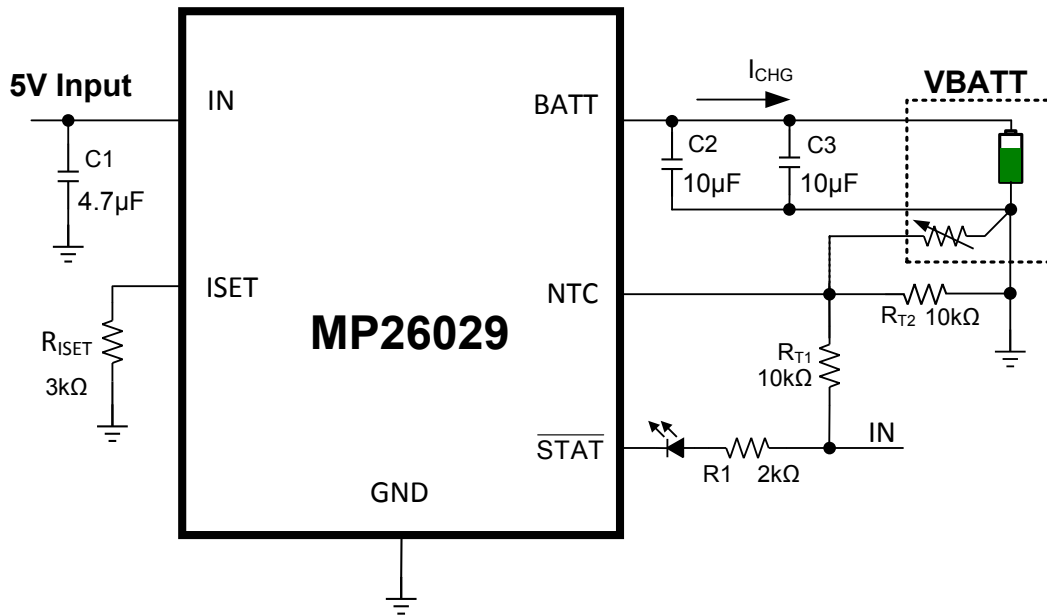
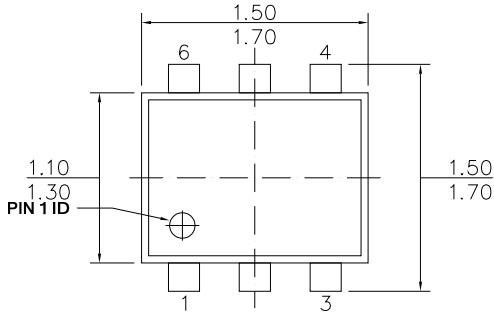
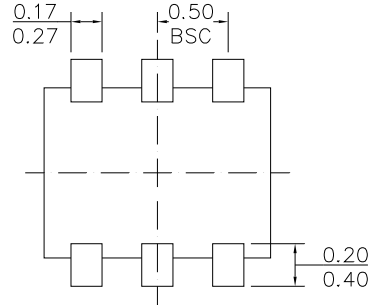
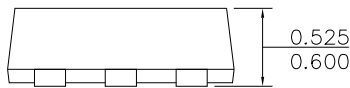
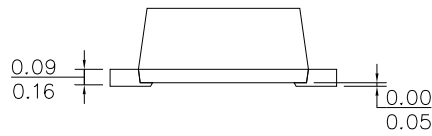
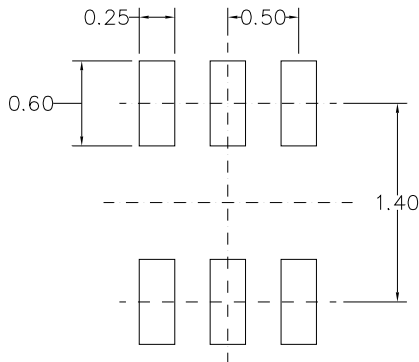

Figure 8: MP26029 Typical Application Circuit with 5V Input

Table 3: Key BOM of Figure 8

Qty	Ref	Value	Description	Package	Manufacture
1	C1	4.7µF	Ceramic Capacitor;16V; X5R or X7R	0603	Any
2	C2, C3	10µF	Ceramic Capacitor;10V; X5R or X7R	0805	Any

PACKAGE INFORMATION
SOT563

TOP VIEW

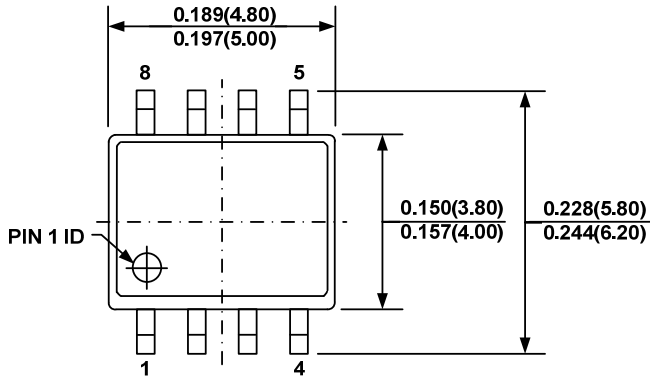
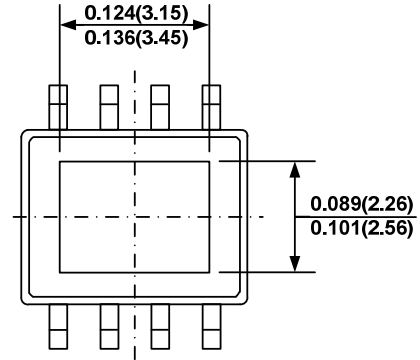
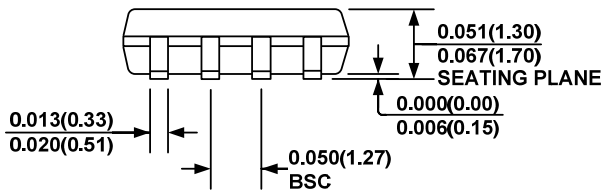
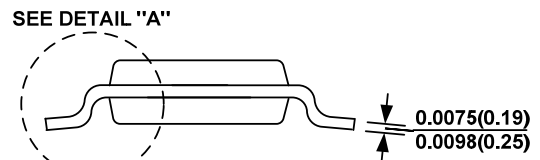
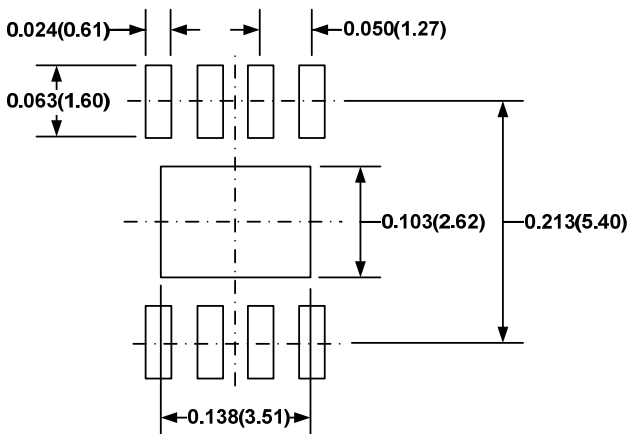
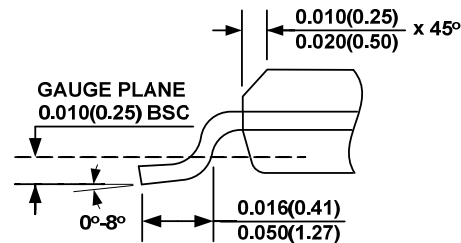
BOTTOM VIEW

FRONT VIEW

SIDE VIEW

RECOMMENDED LAND PATTERN
NOTE:

- 1) ALL DIMENSIONS ARE IN MILLIMETERS.
- 2) PACKAGE LENGTH DOES NOT INCLUDE MOLD FLASH, PROTRUSION OR GATE BURR.
- 3) PACKAGE WIDTH DOES NOT INCLUDE INTERLEAD FLASH OR PROTRUSION.
- 4) LEAD COPLANARITY (BOTTOM OF LEADS AFTER FORMING) SHALL BE 0.10 MILLIMETERS MAX.
- 5) DRAWING CONFORMS TO JEDEC MO-293, VARIATION UAAD.
- 6) DRAWING IS NOT TO SCALE.

PACKAGE INFORMATION *(continued)*
SOIC8 EP

TOP VIEW

BOTTOM VIEW

FRONT VIEW

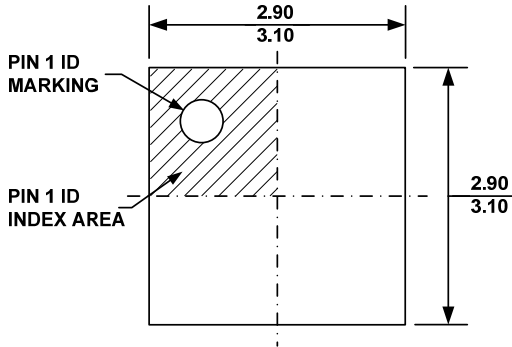
SIDE VIEW

RECOMMENDED LAND PATTERN

DETAIL "A"
NOTE:

- 1) CONTROL DIMENSION IS IN INCHES. DIMENSION IN BRACKET IS IN MILLIMETERS.
- 2) PACKAGE LENGTH DOES NOT INCLUDE MOLD FLASH, PROTRUSIONS OR GATE BURRS.
- 3) PACKAGE WIDTH DOES NOT INCLUDE INTERLEAD FLASH OR PROTRUSIONS.
- 4) LEAD COPLANARITY (BOTTOM OF LEADS AFTER FORMING) SHALL BE 0.004" INCHES MAX.
- 5) DRAWING CONFORMS TO JEDEC MS-012, VARIATION BA.
- 6) DRAWING IS NOT TO SCALE.

PACKAGE INFORMATION *(continued)*

QFN-10 (3mmx3mm)



TOP VIEW

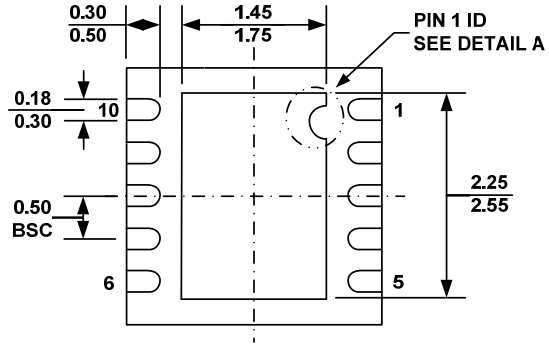

BOTTOM VIEW

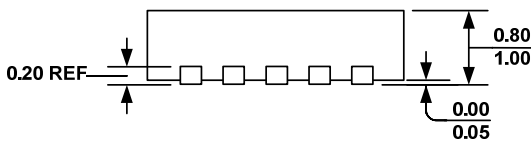

SIDE VIEW

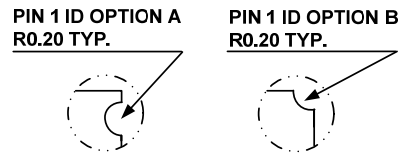

DETAIL A

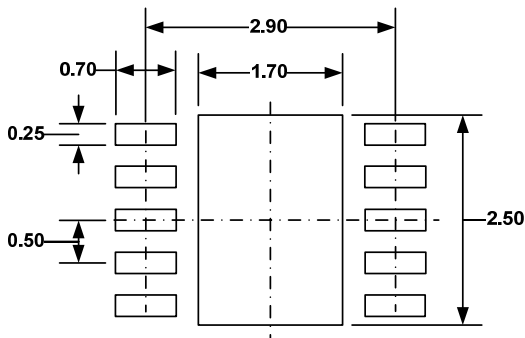

RECOMMENDED LAND PATTERN

NOTE:

- 1) ALL DIMENSIONS ARE IN MILLIMETERS.
- 2) EXPOSED PADDLE SIZE DOES NOT INCLUDE MOLD FLASH.
- 3) LEAD COPLANARITY SHALL BE 0.10 MILLIMETER MAX.
- 4) DRAWING CONFORMS TO JEDEC MO-229, VARIATION VEED-5.
- 5) DRAWING IS NOT TO SCALE.

NOTICE: The information in this document is subject to change without notice. Please contact MPS for current specifications. Users should warrant and guarantee that third party Intellectual Property rights are not infringed upon when integrating MPS products into any application. MPS will not assume any legal responsibility for any said applications.