



40x40x28 mm

San Ace 40W 9WL type   

DC
Splash Proof Fan 40 mm sq.

General Specifications

- Material Frame: Aluminum (Black coating), Impeller: Plastic (Flammability: UL 94V-0)
- Expected life See the table below. (L10 life: 90% survival rate for continuous operation in indoor free air at 60°C, rated voltage)
Expected life at 40°C is for reference only.
- Motor protection function Locked rotor burnout protection, Reverse polarity protection
For details, please refer to p. 573.
- Dielectric strength 50/60 Hz, 500 VAC, for 1 minute (between lead wire conductors and frame)
- Insulation resistance 10 MΩ or more with a 500 VDC megger (between lead wire conductors and frame)
- Sound pressure level (SPL) At 1 m away from the air inlet
- Storage temperature -30 to +70°C (Non-condensing)
- Lead wire ⊕Red ⊖Black Sensor Yellow Control Brown
- Mass 70 g
- Ingress protection IP68

Specifications

The models listed below **have pulse sensors with PWM control function.**

Model no.	Rated voltage [V]	Operating voltage range [V]	PWM duty cycle* [%]	Rated current [A]	Rated input [W]	Rated speed [min ⁻¹]	Max. airflow [m ³ /min] [CFM]	Max. static pressure [Pa] [inchH ₂ O]	SPL [dB (A)]	Operating temperature [°C]	Expected life [h]
9WL0412P3J001	12	10.8 to 13.2	100	0.52	6.24	17500	0.63 22.2	400 1.61	51	-20 to +70	150000/60°C (185000/40°C)
			20	0.06	0.72	3600	0.13 4.6	16.9 0.07	20		
9WL0412P3G001			100	0.4	4.8	15500	0.56 19.7	310 1.24	47		
			20	0.06	0.72	3300	0.12 4.2	14.0 0.06	18		
9WL0424P3J001	24	21.6 to 26.4	100	0.26	6.24	17500	0.63 22.2	400 1.61	51		
			20	0.04	0.96	4000	0.14 5.1	20.9 0.08	22		
9WL0424P3G001			100	0.2	4.8	15500	0.56 19.7	310 1.24	47		
			20	0.04	0.96	3000	0.11 3.8	11.6 0.05	16		

* PWM input frequency is 25 kHz; models without specifications at 0% PWM duty cycle have zero fan speed at 0%.

The following sensor and control options are available for selection.

Available for all models. Without sensor Pulse sensor

Differs according to the model. Refer to the table on p. 611. Lock sensor

Airflow - Static Pressure Characteristics / PWM Duty - Speed Characteristics Example

9WL0412P3J001 With pulse sensor with PWM control function

PWM duty cycle

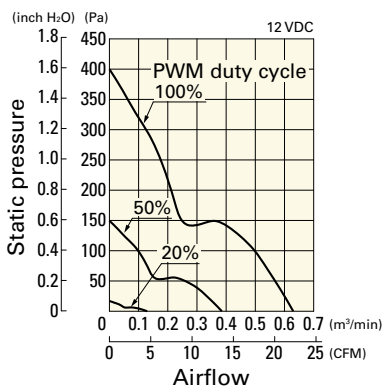

Operating voltage range

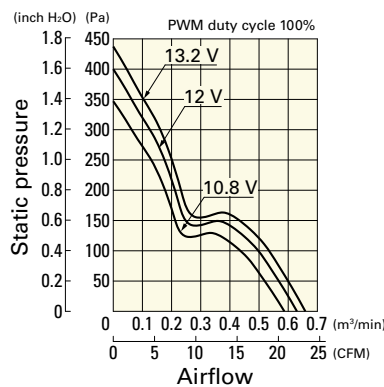

PWM duty - Speed characteristics example

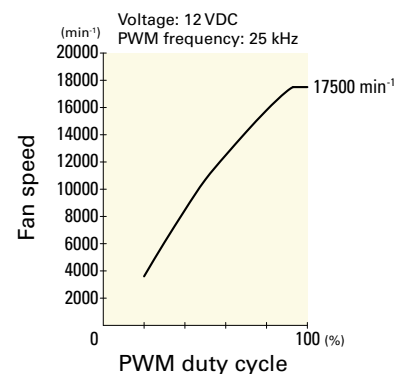

Airflow - Static Pressure Characteristics / PWM Duty - Speed Characteristics Example

9WL0412P3G001 With pulse sensor with PWM control function

PWM duty cycle

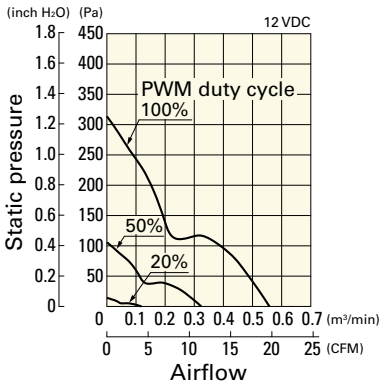

Operating voltage range

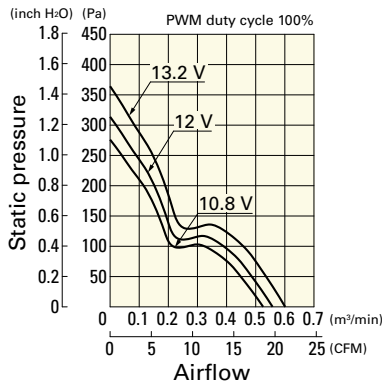

PWM duty - Speed characteristics example

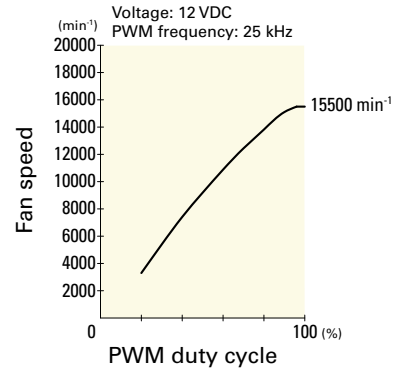

9WL0424P3J001 With pulse sensor with PWM control function

PWM duty cycle

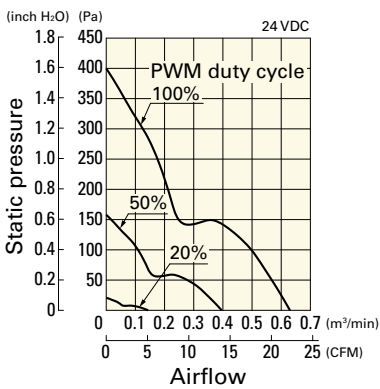

Operating voltage range

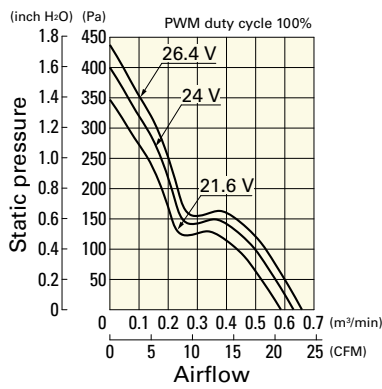

PWM duty - Speed characteristics example

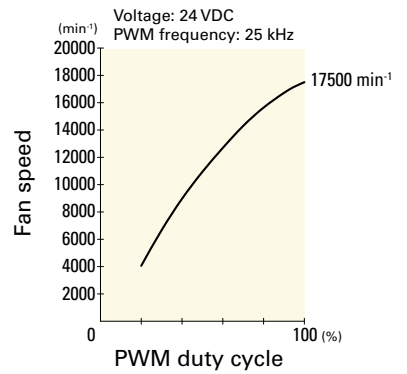

9WL0424P3G001 With pulse sensor with PWM control function

PWM duty cycle

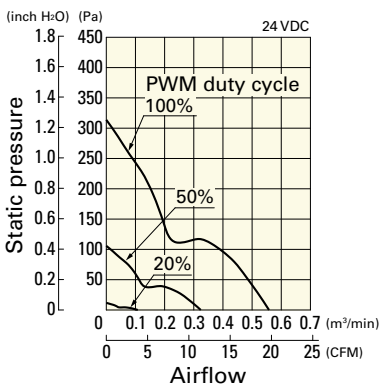

Operating voltage range

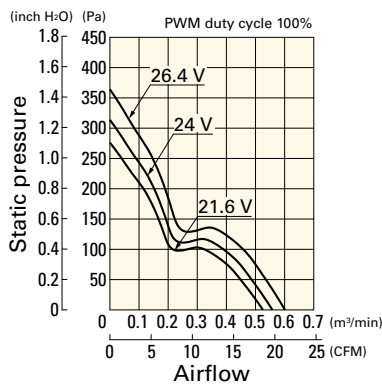

PWM duty - Speed characteristics example

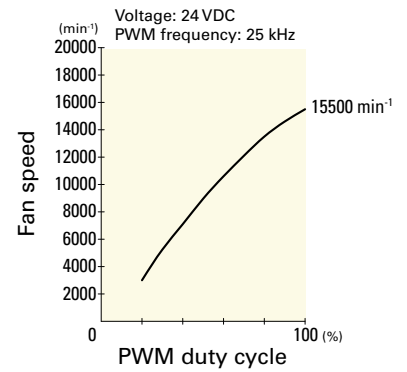

DC
Splash Proof Fan 40 mm sq.

Dimensions (unit: mm)

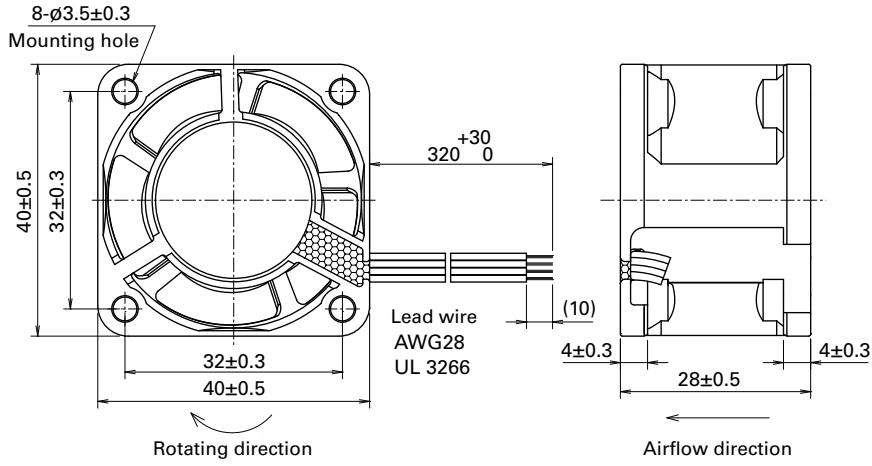

Reference Dimensions of Mounting Holes and Vent Opening (unit: mm)

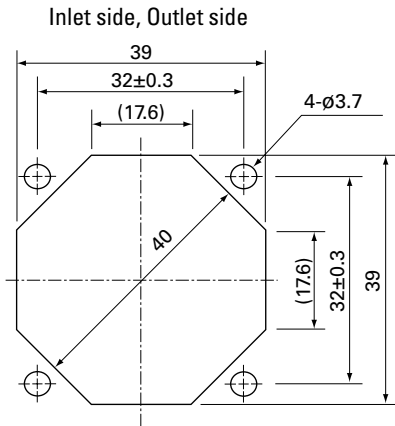

Options

Finger guards

page: p. 558

Model no.: 109-059, 109-059H