

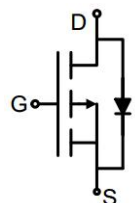
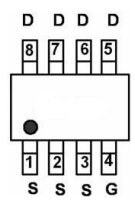

P-Channel Enhancement Mode Power MOSFET

<p>Description</p> <p>The GT2K6P15S uses advanced trench technology to provide excellent $R_{DS(ON)}$, low gate charge. It can be used in a wide variety of applications.</p> <p>General Features</p> <ul style="list-style-type: none"> ● V_{DS} -150V ● I_D (at $V_{GS} = -10V$) -2A ● $R_{DS(ON)}$ (at $V_{GS} = -10V$) < 250mΩ ● 100% Avalanche Tested ● RoHS Compliant <p>Application</p> <ul style="list-style-type: none"> ● Power switch ● DC/DC converters 	 <p>Schematic diagram</p>  <p>pin assignment</p>  <p>SOP-8</p>
--	---

Ordering Information

Device	Package	Marking	Packaging
GT2K6P15S	SOP-8	GT2K6P15	4000pcs/Reel

Absolute Maximum Ratings $T_C = 25^\circ\text{C}$, unless otherwise noted

Parameter	Symbol	Value	Unit
Drain-Source Voltage	V_{DS}	-150	V
Continuous Drain Current	I_D	$T_C = 25^\circ\text{C}$	-2
		$T_C = 100^\circ\text{C}$	-1.3
Pulsed Drain Current (note1)	I_{DM}	-8	A
Gate-Source Voltage	V_{GS}	± 20	V
Power Dissipation	P_D	1.8	W
Single pulse avalanche energy (note2)	E_{AS}	56	mJ
Operating Junction and Storage Temperature Range	T_J, T_{stg}	-55 To 150	$^\circ\text{C}$

Thermal Resistance

Parameter	Symbol	Value	Unit
Thermal Resistance, Junction-to-Ambient	R_{thJA}	69	$^\circ\text{C/W}$

Specifications $T_J = 25^\circ\text{C}$, unless otherwise noted						
Parameter	Symbol	Test Conditions	Value			Unit
			Min.	Typ.	Max.	
Static Parameters						
Drain-Source Breakdown Voltage	$V_{(BR)DSS}$	$V_{GS} = 0V, I_D = -250\mu A$	-150	--	--	V
Zero Gate Voltage Drain Current	I_{DSS}	$V_{DS} = -150V, V_{GS} = 0V$	--	--	-1	μA
Gate-Source Leakage	I_{GSS}	$V_{GS} = \pm 20V$	--	--	± 100	nA
Gate-Source Threshold Voltage	$V_{GS(th)}$	$V_{DS} = V_{GS}, I_D = -250\mu A$	-1.0	-2.5	-3.0	V
Drain-Source On-Resistance	$R_{DS(on)}$	$V_{GS} = -10V, I_D = -2A$	--	210	250	m Ω
Forward Transconductance	g_{FS}	$V_{DS} = -5V, I_D = -2A$	--	14	--	S
Dynamic Parameters						
Input Capacitance	C_{iss}	$V_{GS} = 0V,$ $V_{DS} = -75V,$ $f = 1.0MHz$	--	1400	--	pF
Output Capacitance	C_{oss}		--	60	--	
Reverse Transfer Capacitance	C_{rss}		--	1	--	
Total Gate Charge	Q_g	$V_{DD} = -75V,$ $I_D = -2A,$ $V_{GS} = -10V$	--	36	--	nC
Gate-Source Charge	Q_{gs}		--	4	--	
Gate-Drain Charge	Q_{gd}		--	8	--	
Turn-on Delay Time	$t_{d(on)}$	$V_{DD} = -75V,$ $I_D = -2A,$ $R_G = 1.6\Omega$	--	26	--	ns
Turn-on Rise Time	t_r		--	7	--	
Turn-off Delay Time	$t_{d(off)}$		--	28	--	
Turn-off Fall Time	t_f		--	12	--	
Drain-Source Body Diode Characteristics						
Continuous Body Diode Current	I_S	$T_C = 25^\circ\text{C}$	--	--	-2	A
Body Diode Voltage	V_{SD}	$T_J = 25^\circ\text{C}, I_{SD} = -2A, V_{GS} = 0V$	--	--	-1.2	V
Reverse Recovery Charge	Q_{rr}	$I_F = -2A, V_{GS} = 0V$ $di/dt = -100A/\mu s$	--	150	--	nC
Reverse Recovery Time	T_{rr}		--	37	--	ns

Notes

1. Repetitive Rating: Pulse width limited by maximum junction temperature
2. EAS condition : $T_J = 25^\circ\text{C}, V_{DD} = -50V, V_{GS} = -10V, L = 0.5mH, R_g = 25\Omega$

The table shows the minimum avalanche energy, which is 156mJ when the device is tested until failure

3. Identical low side and high side switch with identical R_G

Gate Charge Test Circuit



Switch Time Test Circuit



EAS Test Circuit



Typical Characteristics $T_J = 25^\circ\text{C}$, unless otherwise noted

Figure 1. Output Characteristics

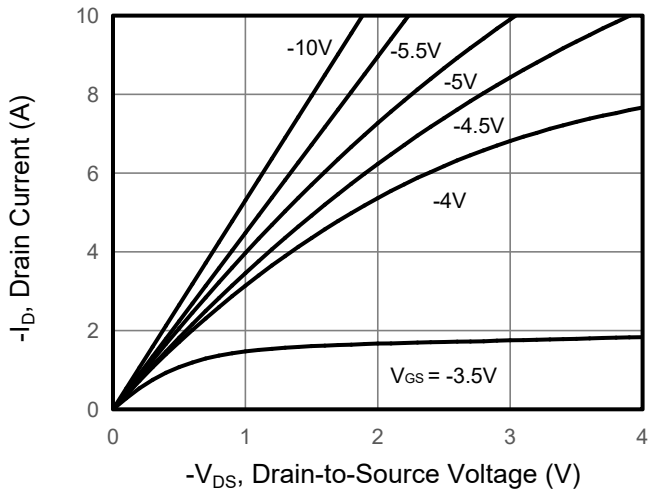

Figure 2. Transfer Characteristics

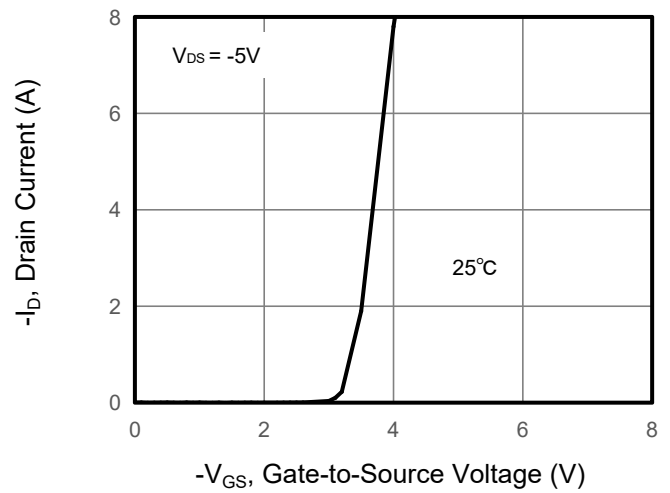

Figure 3. Drain Source On Resistance

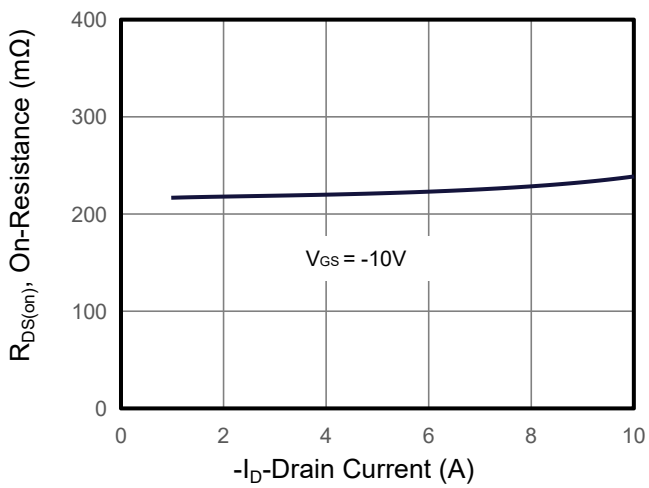

Figure 4. Gate Charge

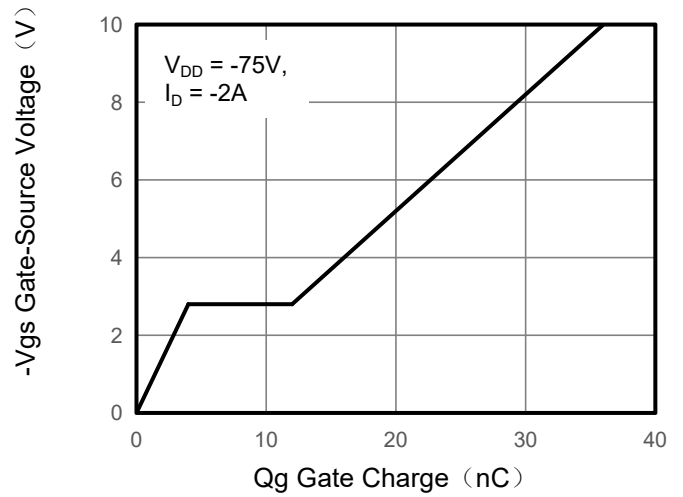

Figure 5. Capacitance

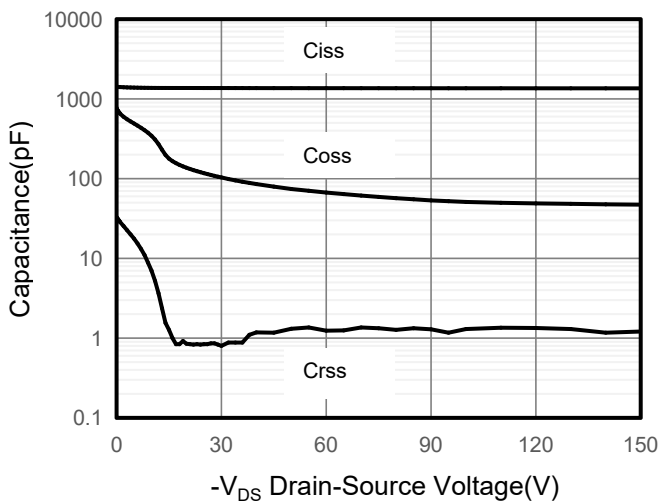
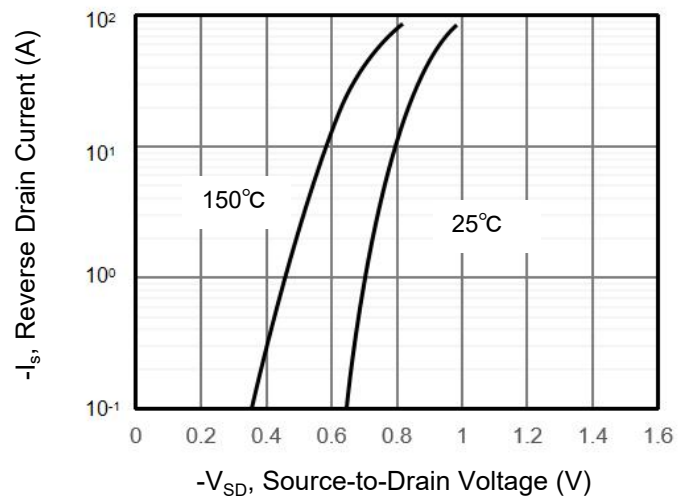

Figure 6. Source-Drain Diode Forward



Typical Characteristics $T_J = 25^\circ\text{C}$, unless otherwise noted

Figure 7. Drain-Source On-Resistance

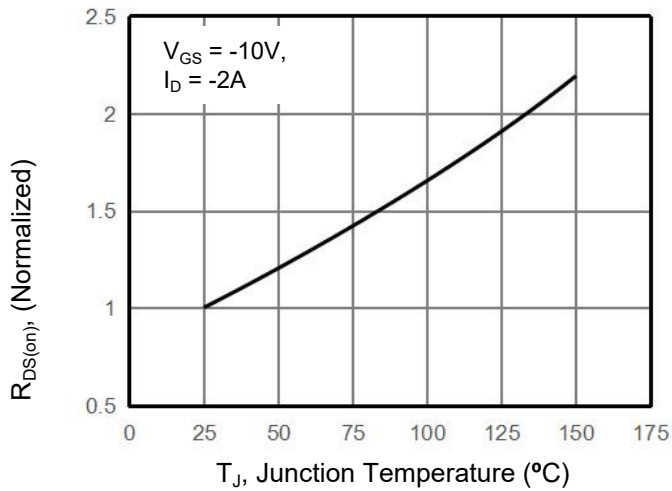

Figure 8. Safe Operation Area

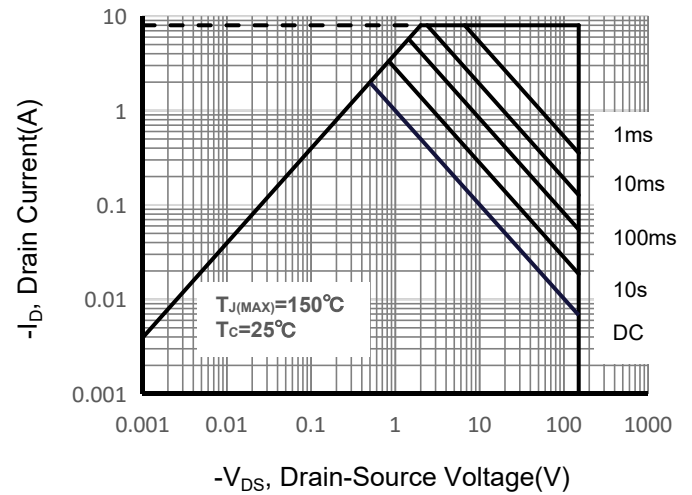

Figure 9. Maximum Continuous Drain Current vs Case Temperature

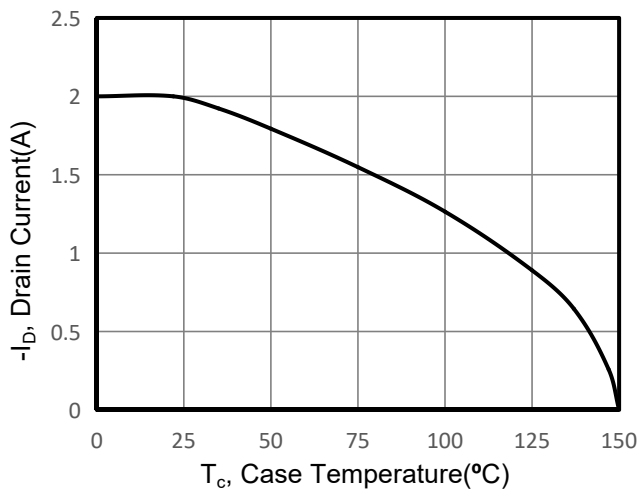
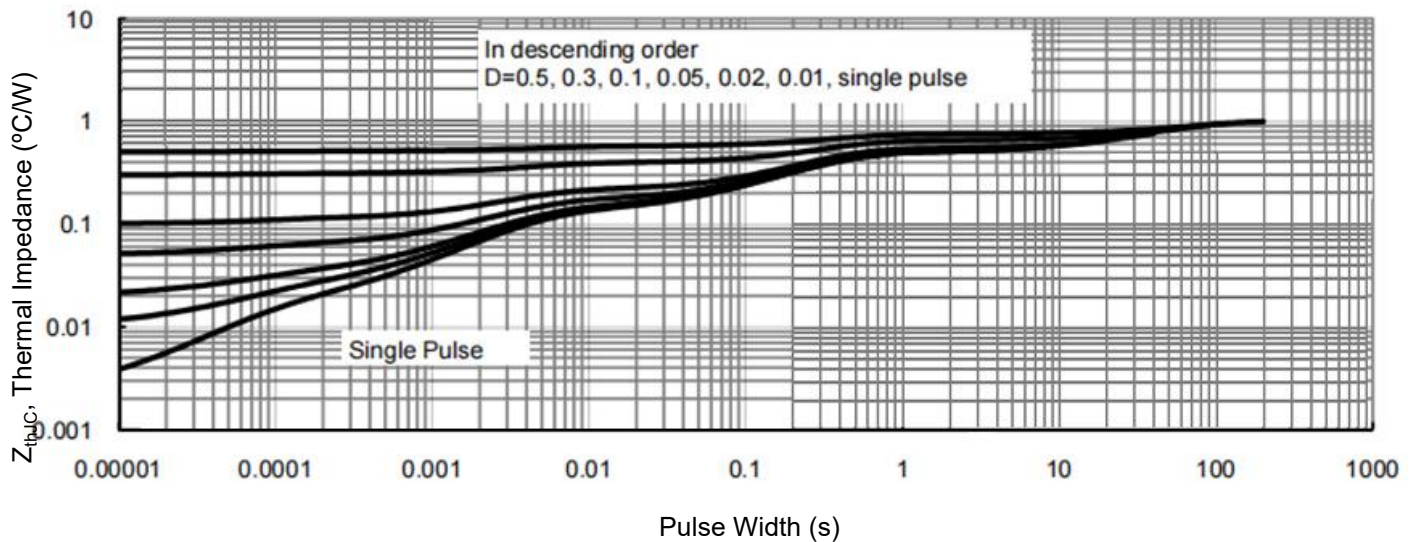
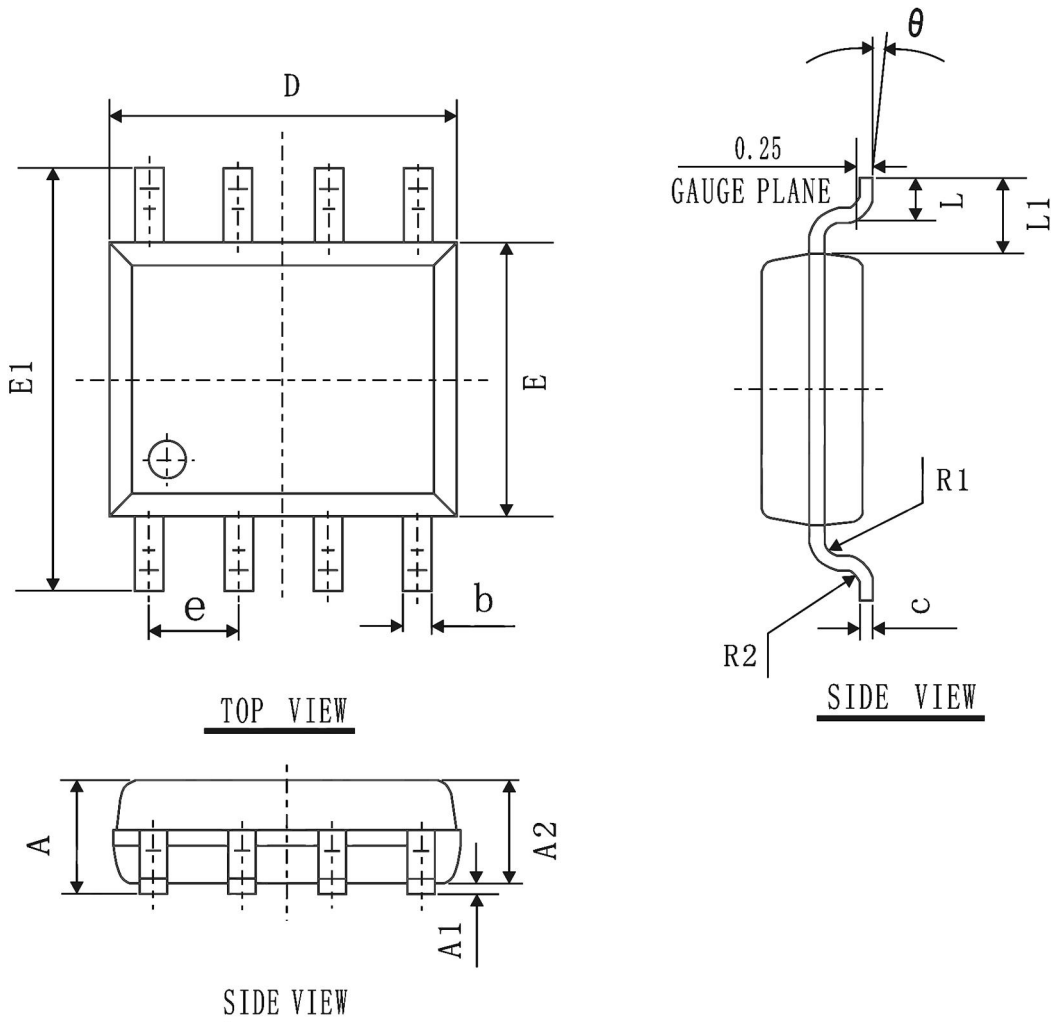

Figure 10. Normalized Maximum Transient Thermal Impedance



SOP-8 Package Information



COMMON DIMENSIONS
(UNITS OF MEASURE=mm)

SYMBOL	MIN	NOM	MAX
A	1.40	1.60	1.80
A1	0.05	0.15	0.25
A2	1.35	1.45	1.55
b	0.30	0.40	0.50
c	0.153	0.203	0.253
D	4.80	4.90	5.00
E	3.80	3.90	4.00
E1	5.80	6.00	6.20
L	0.45	0.70	1.00
θ	2°	4°	6°
L1	1.04 REF		
e	1.27 BSC		
R1	0.07 TYP		
R2	0.07 TYP		