

SUMMARY



Image is for illustrative purpose only

Wires

Low voltage 2

Series 0S
Termination type Male solder
IP rating 50
AWG wire size 30.00 - 22.00
Cable Ø 3.80 - 4.40 mm
Status active
Matching parts [ERA.0S.302.CLL](#)

Download

[Request a quote](#)
[Eplan](#)
[Catalog](#)

TECHNICAL DETAILS

Mechanics

Shell Style/Model FFA*: Straight plug, cable collet
Keying Hermaphroditic keying (half moon insert) with male pin 1
Housing Material Brass (chrome plated [SAE AMS 2460]) shell and collet nut, nickel plated [SAE AMS QQ N 290] brass latch sleeve and mid pieces
Weight 7.77 g

Performance

Configuration 0S.302 : 2 Low Voltage
Insulator L: PEEK (UL 94 / V-0/1.5)
Rated Current 10 Amps

Specifications

Contact Type: Solder
Contact Dia.: 0.9 mm (0.0354in)
Bucket Dia.: 0.8 mm (0.031in)
Max. Solid Conductor: 0.34 mm² (AWG 22)
R (max): 4.8 mOhm
Vtest: 1500 V (AC), 2100 V (DC)

Others

LEMO products and services are provided "as is". LEMO makes no warranties or representations with regard to LEMO product & services or use of them, express, implied or statutory, including for accuracy, completeness, or security. The user is fully responsible for his products and applications using LEMO components.

Endurance (Shell): 5000 mating cycles
 Temp (min / max): -55°C / +250°C
 Humidity (max): <=95% [at 60 deg C / 140 F]
 Vibration: 15 g [10 Hz - 2000 Hz]
 Shock Resistance: 100 g [6 ms]
 Climatical Category: 50/175/21
 Shielding (min): 75 dB (10 MHz)
 Shielding (min): 40 dB (1 GHz)
 Salt Spray Corrosion: >144 hr

DRAWINGS

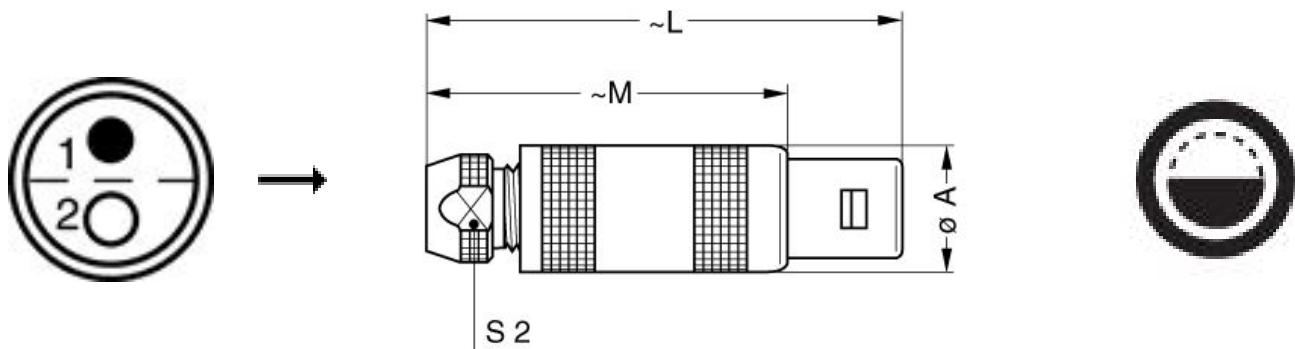

Dimensions

| | A | L | M | S2 |
|-----|------|------|------|------|
| mm. | 9 | 34.5 | 24.5 | 6.5 |
| in. | 0,35 | 1,36 | 0,96 | 0,26 |











RECOMMENDED BY LEMO

Tools

Spanner wrench: [DCD.05.005.PA065](#)

LEMO products and services are provided "as is". LEMO makes no warranties or representations with regard to LEMO product & services or use of them, express, implied or statutory, including for accuracy, completeness, or security. The user is fully responsible for his products and applications using LEMO components.

Cables

| | | | |
|--------|-----|--------|--|
| 120250 | PVC | Grey |  |
| 20140 | PVC | Grey |  |
| 20140 | PVC | Grey |  |
| 20142 | PVC | Red |  |
| 20143 | PVC | Green |  |
| 20144 | PVC | Black |  |
| 20145 | PVC | Yellow |  |
| 20146 | PVC | Black |  |
| 20260 | PVC | Black |  |
| 20264 | PVC | Black |  |
| 20266 | PVC | Violet |  |
| 2280 | PVC | Black |  |

LEMO products and services are provided "as is". LEMO makes no warranties or representations with regard to LEMO product & services or use of them, express, implied or statutory, including for accuracy, completeness, or security. The user is fully responsible for his products and applications using LEMO components.