

REVISION X

DO NOT SCALE FROM THIS PRINT

NOTES:

1. Ⓢ REPRESENTS A CRITICAL DIMENSION.
2. ASSEMBLE GOLD PLATED END AS SHOWN.
3. TERMINAL PUSHOUT FORCE: 2 lbf BEFORE HEAT.
4. TERMINALS TO BE FLUSH TO .010[.25] BELOW TOP OF SHROUD.

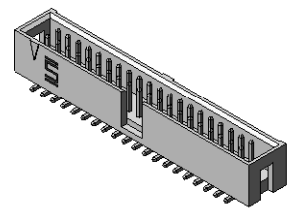

HTST-1XX-01-XX-DV-XX-XX

- PACKAGING OPTION**
-TR: TAPE & REEL (POSITIONS -02 THRU -25 ONLY)
- OPTION**
-A: ALIGNMENT PIN (* ASO OPTION) (SEE FIG. 3 SHT. 2)
-P: PICK & PLACE PAD (USE PPP-22)
-XX: POLARIZATION OPTION (INDICATES POSITION OMITTED)
- ROW SPECIFICATION**
-DV: DOUBLE VERTICAL (USE HTST-XX-D)
- LEAD STYLE**
-01: SURFACE MOUNT (USE T-1S6-08-X-2)
- No OF POSITIONS**
-02 THRU -36 (PER ROW)
- PLATING SPECIFICATION**
-T: MATTE TIN, CONTACT AND TAIL
-S: SELECTIVE, 30 Au / 50 Ni MIN ON CONTACT, MATTE TIN TAIL
-L: LIGHT SELECTIVE, 10 Au / 50 Ni MIN ON CONTACT, MATTE TIN TAIL
-H: HEAVY GOLD, 30 Au / 50 Ni MIN ON CONTACT, 3 Au / 50 Ni MIN ON TAIL
-F: FLASH SELECTIVE, 3 Au / 50 Ni MIN ON CONTACT, MATTE TIN TAIL
-TM: MATTE TIN CONTACT AND TAIL
-SM: SELECTIVE, 30 Au / 50 Ni MIN ON CONTACT, MATTE TIN TAIL
-FM: FLASH SELECTIVE, 3 Au / 50 Ni MIN ON CONTACT, MATTE TIN TAIL
-LM: LIGHT SELECTIVE, 10 Au / 50 Ni MIN ON CONTACT, MATTE TIN TAIL

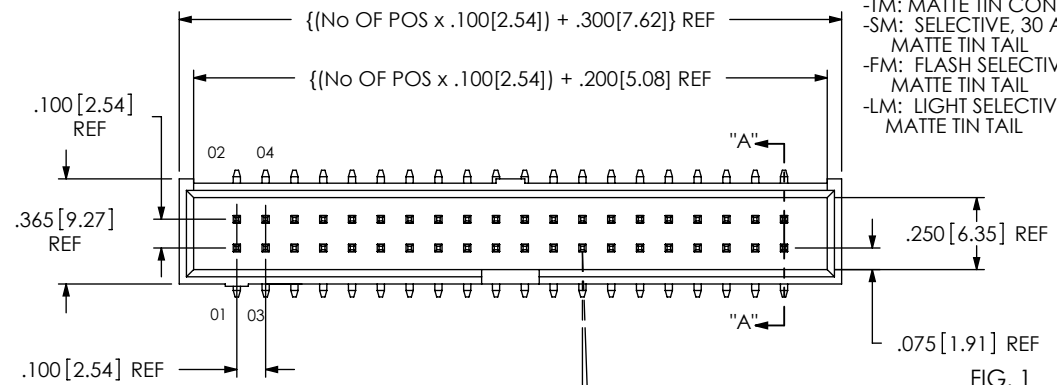
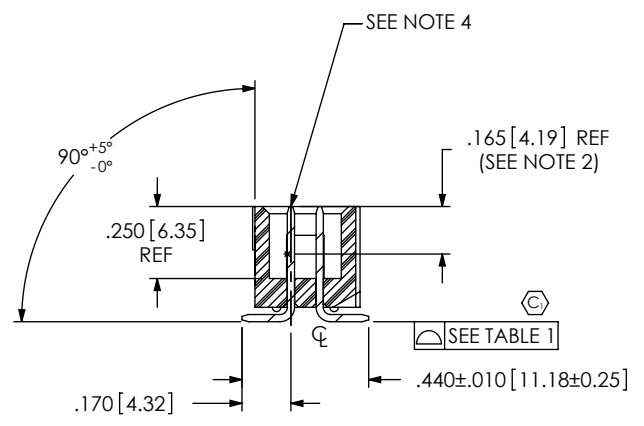
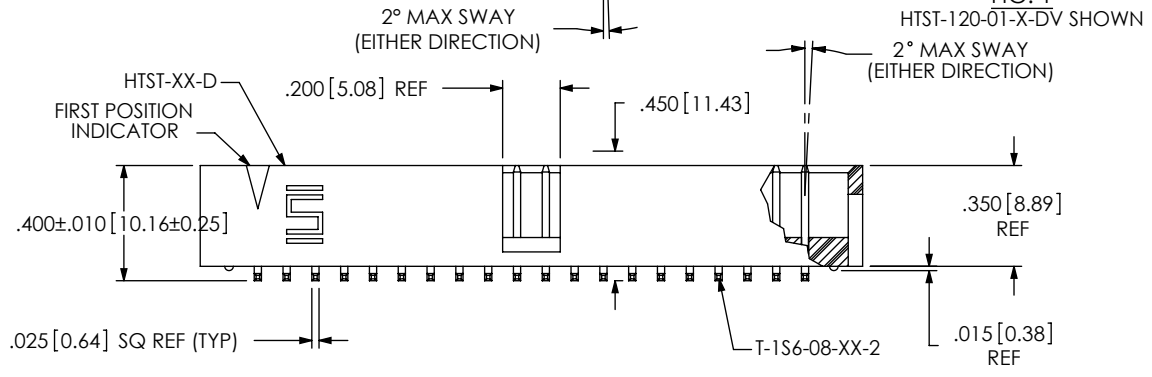

TABLE 1

POSITIONS	COPLANARITY
-02 THRU -15	.0040[.102]
-16 THRU -36	.0060[.152]



UNLESS OTHERWISE SPECIFIED, DIMENSIONS ARE IN INCHES. TOLERANCES ARE:
DECIMALS ANGLES
.XX: ±.01 [.3] 2°
.XXX: ±.005 [.13]
.XXXX: ±.0020 [.051]

PROPRIETARY NOTE
THIS DOCUMENT CONTAINS INFORMATION CONFIDENTIAL AND PROPRIETARY TO SAMTEC, INC. AND SHALL NOT BE REPRODUCED OR TRANSFERRED TO OTHER DOCUMENTS OR DISCLOSED TO OTHERS OR USED FOR ANY PURPOSE OTHER THAN THAT WHICH IT WAS OBTAINED WITHOUT THE EXPRESSED WRITTEN CONSENT OF SAMTEC, INC.

SECTION "A"- "A"

520 PARK EAST BLVD, NEW ALBANY, IN 47150
PHONE: 812-944-6733 FAX: 812-948-5047
e-Mail: info@SAMTEC.com code: 55322

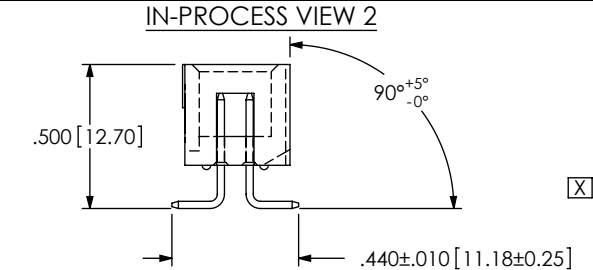
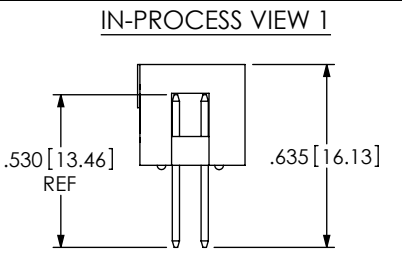

MATERIAL: DO NOT SCALE DRAWING SHEET SCALE: 1.5:1
INSULATOR: LCP, UL 94 VO COLOR: NATURAL
TERMINAL: PHOS BRONZE
F:\DWG\MISC\MKTG\HTST-1XX-01-XX-DV-XX-XX-MKT.SLDDRW

DESCRIPTION: HIGH TEMP TOP SHROUD
DWG. NO.: HTST-1XX-01-XX-DV-XX-XX
BY: T. WERNE 07/11/2001 **SHEET 1 OF 3**

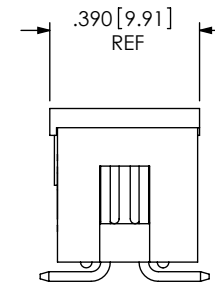
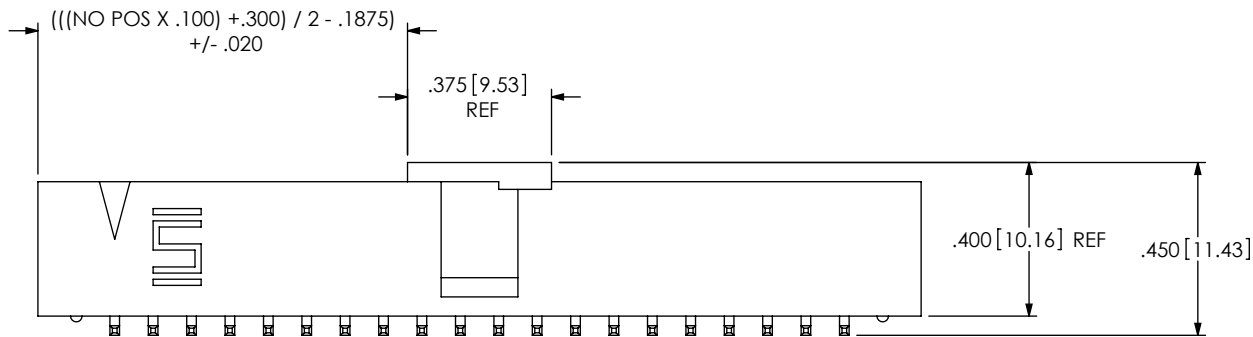

FIG. 2

-P: PICK & PLACE PAD OPTION
(SAME AS FIG. 1 UNLESS OTHERWISE STATED)

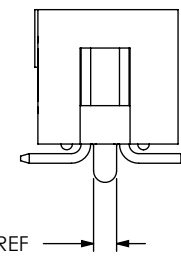
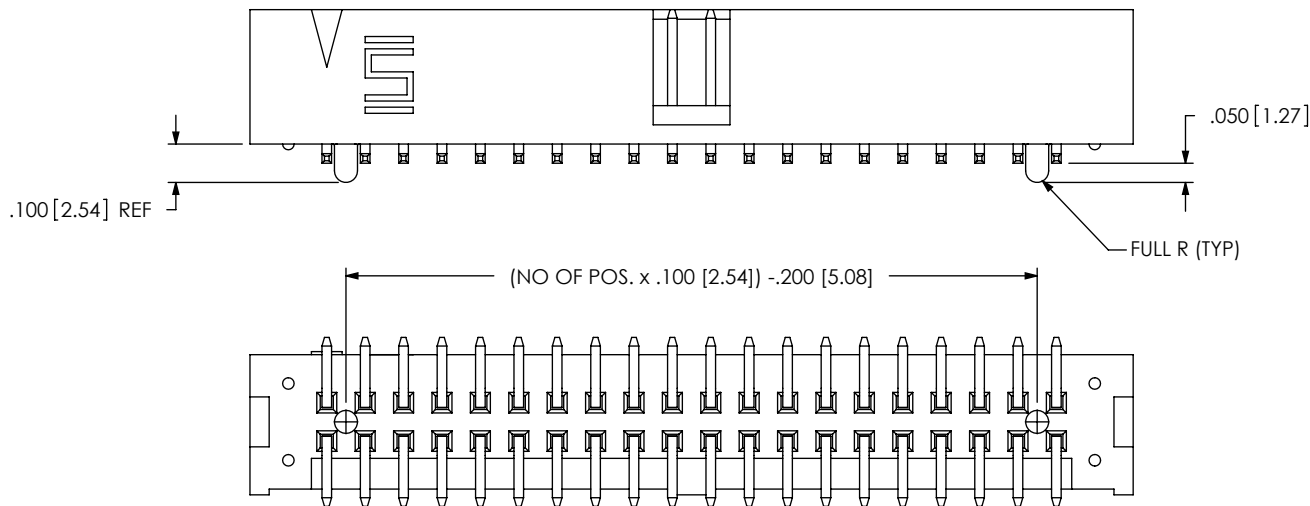

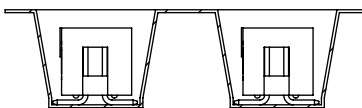
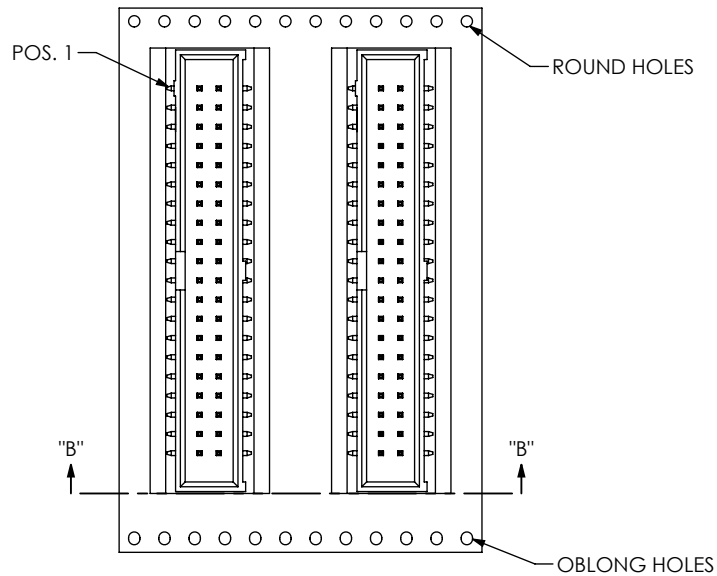

FIG. 3

-A: ALIGNMENT PIN OPTION
(SAME AS FIG. 1 UNLESS OTHERWISE STATED)

<p>PROPRIETARY NOTE THIS DOCUMENT CONTAINS INFORMATION CONFIDENTIAL AND PROPRIETARY TO SAMTEC, INC. AND SHALL NOT BE REPRODUCED OR TRANSFERRED TO OTHER DOCUMENTS OR DISCLOSED TO OTHERS OR USED FOR ANY PURPOSE OTHER THAN THAT WHICH IT WAS OBTAINED WITHOUT THE EXPRESSED WRITTEN CONSENT OF SAMTEC, INC.</p> <p>DO NOT SCALE DRAWING</p> <p>SHEET SCALE: 2:1</p>	
	<p>520 PARK EAST BLVD., NEW ALBANY, IN 47150 PHONE: 812-944-6733 FAX: 812-948-5047 e-Mail: info@SAMTEC.com code: 55322</p>
	<p>DESCRIPTION: HIGH TEMP TOP SHROUD</p>
	<p>DWG. NO. HTST-1XX-01-XX-DV-XX-XX</p>
<p>BY: T. WERNE 07/11/2001 SHEET 2 OF 3</p>	



SECTION "B"-"B"
SCALE 1 : 1

USER DIRECTION OF REELING →
POCKET NOT DETAILED

TAPE & REEL VIEW

TUBE VIEW

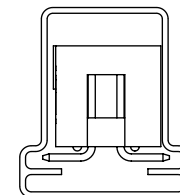

TUBE: PT-1-24-02-08
PLUG: TP-13

PROPRIETARY NOTE

THIS DOCUMENT CONTAINS INFORMATION CONFIDENTIAL AND PROPRIETARY TO SAMTEC, INC. AND SHALL NOT BE REPRODUCED OR TRANSFERRED TO OTHER DOCUMENTS OR DISCLOSED TO OTHERS OR USED FOR ANY PURPOSE OTHER THAN THAT WHICH IT WAS OBTAINED WITHOUT THE EXPRESSED WRITTEN CONSENT OF SAMTEC, INC.

DO NOT SCALE DRAWING

SHEET SCALE: 2:1

samtec

520 PARK EAST BLVD, NEW ALBANY, IN 47150
PHONE: 812-944-6733 FAX: 812-948-5047
e-Mail: info@SAMTEC.com code: 55322

DESCRIPTION:
HIGH TEMP TOP SHROUD

DWG. NO.
HTST-1XX-01-XX-DV-XX-XX

BY: T. WERNE 07/11/2001 SHEET 3 OF 3