

MLA Varistor Series

Surface Mount Multilayer Varistors (MLVs)



Description

The MLA Series family of transient voltage surge suppression devices is based on the Littelfuse Multilayer fabrication technology. These components are designed to suppress a variety of transient events, including those specified in IEC 61000-4-2 or other standards used for Electromagnetic Compliance (EMC). The MLA Series is typically applied to protect integrated circuits and other components at the circuit board level.

The wide operating voltage and energy range make the MLA Series suitable for numerous applications on power supply, control and signal lines.

The MLA Series is manufactured from semiconducting ceramics, and is supplied in a leadless, surface mount package. The MLA Series is compatible with modern reflow and wave soldering procedures.

It can operate over a wider temperature range than Zener diodes, and has a much smaller footprint than plastic-housed components.

Littelfuse Inc. manufactures other multilayer series products. See the MLE Series data sheet for ESD applications, MHS Series data sheet for high-speed ESD applications, the MLN Series for multiline protection and the AUML Series for automotive applications.

Additional Information



Resources



Accessories



Samples

Size Table

Metric	EIA
1005	0402
1608	0603
2012	0805
3216	1206
3225	1210

Absolute Maximum Ratings

• For ratings of individual members of a series, see device ratings and specifications table.

Continuous	ML Series	Units
Steady State Applied Voltage		
DC Voltage Range (V_{MDC})	3.5 to 120	V
AC Voltage Range ($V_{MIACRMS}$)	2.5 to 107	V
Transient		
Non-Repetitive Surge Current, 8/20 μ s Waveform, (I_{TM})	4 to 500	A
Non-Repetitive Surge Energy, 10/1000 μ s Waveform, (W_{TM})	0.02 to 2.5	J
Operating Ambient Temperature Range (T_A)	-40 to +125	°C
Storage Temperature Range (T_{STG})	-40 to +150	°C
Temperature Coefficient (αV) of Clamping Voltage (V_C) at Specified Test Current	<0.01	%/°C

Features

- Halogen-Free and RoHS compliant
- Leadless 0402, 0603, 0805, 1206 and 1210 chip sizes
- Multilayer ceramic construction technology
- -40°C to +125°C operating temp. range
- Operating voltage range VM(DC) = 3.5V to 120v
- Rated for surge current (8 x 20 μ s)
- Rated for energy (10 x 1000 μ s)
- Inherent bi-directional clamping
- Standard low capacitance types available

Applications

- Suppression of inductive switching or other transient events such as EFT and surge voltage at the circuit board level
- ESD protection for IEC 61000-4-2, MIL-STD-883 method 3015.7, and other industry specifications (see also the MLE or MLN Series)
- Provides on-board transient voltage protection for ICS and transistors
- Used to help achieve electromagnetic compliance of end products
- Replace larger surface mount TVS Zeners in many applications

MLA Varistor Series

Surface Mount Multilayer Varistors (MLVs)

Device Ratings and Specifications

Part Number	Maximum Ratings (125°C)					Specifications (25°C)		
	Maximum Continuous Working Voltage		Maximum Non-repetitive Surge Current (8/20 μ s)	Maximum Non-repetitive Surge Energy(10/1000 μ s)	Maximum Clamping Voltage(8/20 μ s)	Nominal Voltage Test Current@ 1mA DC		Typical Capacitance@ 1MHz
	VM (DC)	VM (AC)	I _{TM}	WTM	VC @ 1A	VN (DC)	VN (DC)	C
	(V)	(V)	(A)	(J)	(V)	Min (V)	Max (V)	(pF)
V3.5MLA0603N ⁵	3.5	2.5	30	0.100	13.0	3.7	7.0	1270
V3.5MLA0805N	3.5	2.5	60	0.300	13.0	3.7	7.0	1760
V3.5MLA0805LN	3.5	2.5	40	0.100	13.0	3.7	7.0	1380
V3.5MLA1206N	3.5	2.5	100	0.300	13.0	3.7	7.0	5800
V5.5MLA0402N ⁸	5.5	4.0	20	0.050	21.0	7.1	10.8	220
V5.5MLA0402LN ⁸	5.5	4.0	20	0.05	39	15.9	21.5	70
V5.5MLA0603N ⁵	5.5	4.0	30	0.100	17.5	7.1	9.3	960
V5.5MLA0603LN ⁴	5.5	4.0	30	0.100	17.5	7.1	9.3	450
V5.5MLA0805N	5.5	4.0	120	0.300	17.5	7.1	9.3	1200
V5.5MLA0805LN	5.5	4.0	40	0.100	17.5	7.1	9.3	660
V5.5MLA1206N	5.5	4.0	150	0.400	17.5	7.1	9.3	2800
V9MLA0402N ⁸	9.0	6.5	20	0.050	30.0	11.0	16.0	120
V9MLA0402LN ⁸	9.0	6.5	4	0.020	35.0	11.0	16.0	33
V9MLA0603N ^{5 8}	9.0	6.5	30	0.100	25.5	11.0	16.0	490
V9MLA0603LN ^{4 8}	9.0	6.5	30	0.100	25.5	11.0	16.0	360
V9MLA0805LN ⁸	9.0	6.5	40	0.100	25.5	11.0	16.0	320
V12MLA0805LN ⁸	12.0	9.0	40	0.100	29.0	14.0	18.5	220
V14MLA0402N ⁸	14.0	10.0	20	0.050	39.0	15.9	21.5	70
V14MLA0603N ⁸	14.0	10.0	30	0.100	34.5	15.9	21.5	180
V14MLA0805N ⁸	14.0	10.0	120	0.300	32.0	15.9	20.3	360
V14MLA0805LN ⁸	14.0	10.0	40	0.100	32.0	15.9	20.3	200
V14MLA1206N ⁸	14.0	10.0	150	0.400	32.0	15.9	20.3	800
V18MLA0402N ⁸	18.0	14.0	20	0.050	50.0	22.0	28.0	40
V18MLA0603N ⁸	18.0	14.0	30	0.100	50.0	22.0	28.0	120
V18MLA0805N ⁸	18.0	14.0	120	0.300	44.0	22.0	28.0	260
V18MLA0805LN ⁸	18.0	14.0	40	0.100	44.0	22.0	28.0	170
V18MLA1206N ⁸	18.0	14.0	150	0.400	44.0	22.0	28.0	1030
V18MLA1210N ⁸	18.0	14.0	500	2.500	44.0 at 2.5	22.0	28.0	2500
V18MLA1812N ^{7 8}	18.0	14.0	1000	2.900	44.0 at 5	22.0	28.0	4050
V26MLA0603N ⁸	26.0	20.0	30	0.100	60.0	31.0	38.0	110
V26MLA0805N ⁸	26.0	20.0	100	0.300	60.0	29.5	38.5	110
V26MLA0805LN ⁸	26.0	20.0	40	0.100	60.0	29.5	38.5	90
V26MLA1206N ⁸	26.0	20.0	150	0.600	60.0	29.5	38.5	630
V26MLA1210N ⁸	26.0	20.0	300	1.200	60.0 at 2.5	29.5	38.5	1250
V30MLA0603N ⁸	30.0	25.0	30	0.100	74.0	37.0	46.0	90
V30MLA0805LN ⁸	30.0	25.0	30	0.100	72.0	37.0	46.0	85
V30MLA1206N ⁸	30.0	25.0	180	1.000	67.0	35.0	43.0	400
V30MLA1210N ⁸	30.0	25.0	280	1.200	68.0 at 2.5	35.0	43.0	685
V30MLA1210LN ⁸	30.0	25.0	220	0.900	68.0 at 2.5	35.0	43.0	500

MLA Varistor Series

Surface Mount Multilayer Varistors (MLVs)

Device Ratings and Specifications (Continue...)

Part Number	Maximum Ratings (125°C)					Specifications (25°C)		
	Maximum Continuous Working Voltage		Maximum Non-repetitive Surge Current (8/20 μ s)	Maximum Non-repetitive Surge Energy(10/1000 μ s)	Maximum Clamping Voltage(8/20 μ s)	Nominal Voltage Test Current@ 1mA DC		Typical Capacitance@ 1MHz
	VM (DC)	VM (AC)	I _{TM}	WTM	VC @ 1A	VN (DC)	VN (DC)	C
	(V)	(V)	(A)	(J)	(V)	Min (V)	Max (V)	(pF)
V30MLA1812N ^{7,8}	30.0	25.0	800	3.700	65.0 at 5	35.0	43.0	1900
V33MLA1206N ⁸	33.0	26.0	180	0.800	75.0	38.0	49.0	390
V38MLA1812N ^{7,8}	38.0	30.0	800	4.500	77.0 at 5	43.0	52.0	1450
V42MLA1206N ⁸	42.0	30.0	180	0.800	92.0	46.0	60.0	345
V45MLA1812N ^{7,8}	45.0	35.0	500	4.000	90.0 at 5	50.4	61.6	1200
V48MLA1206N ⁸	48.0	40.0	180	0.900	100.0	54.5	66.5	185
V48MLA1210N ⁸	48.0	40.0	250	1.200	105.0 at 2.5	54.5	66.5	400
V48MLA1210LN ⁸	48.0	40.0	220	0.900	105.0 at 2.5	54.5	66.5	380
V56MLA1206N ⁸	56.0	40.0	180	1.000	120.0	61.0	77.0	180
V60MLA1210N ⁸	60.0	50.0	250	1.500	130.0 at 2.5	67.0	83.0	230
V68MLA1206N ⁸	68.0	50.0	180	1.000	140.0	76.0	90.0	130
V85MLA1210N ⁸	85.0	67.0	250	2.500	180.0 at 2.5	95.0	115.0	160
V120MLA1210N ⁸	120.0	107.0	125	2.000	260.0 at 2.5	135.0	165.0	70

Notes:

- 'L' suffix is a low capacitance and energy version; Contact your Littelfuse sales representative for custom capacitance requirements.
- Typical leakage at 25°C < 25 μ A, maximum leakage 100 μ A at V_{MIDDC}; for 0402 size, typical leakage < 5 μ A, maximum leakage < 20 μ A at V_{MIDDC}.
- Average power dissipation of transients for 0402, 0603, 0805, 1206 and 1210 sizes not to exceed 0.03W, 0.05W, 0.1W, 0.1W and 0.15W respectively.
- Item is available as 'R' packing option only. All 0402 size items available as 'R' packaging option only. See Packaging section for additional information.
- Item is available in 'H', 'T' and 'A' packing option only. All 0805, 1206 and 1210 parts come as 'H', 'T' and 'A' packing option only. See Packaging section for additional information.
- The typical capacitance rating is the discrete component test result.
- Item is available in 'T' packing option only.
- ESD rated to IEC61000-4-2 level 4: air discharge 15KV, contact 8KV
- ESD higher rating than IEC61000-4-2(level 4), please contact littelfuse

MLA Varistor Series

Surface Mount Multilayer Varistors (MLVs)

Peak Current and Energy Derating Curve

When transients occur in rapid succession, the average power dissipation is the energy (watt-seconds) per pulse times the number of pulses per second. The power so developed must be within the specifications shown on the Device Ratings and Specifications Table for the specific device. For applications exceeding 125°C ambient temperature, the peak surge current and energy ratings must be derated as shown below.

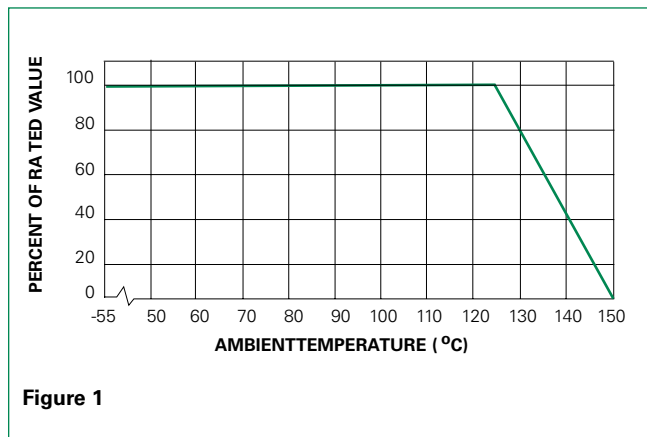

Figure 1

Peak Pulse Current Test Waveform for Clamping Voltage

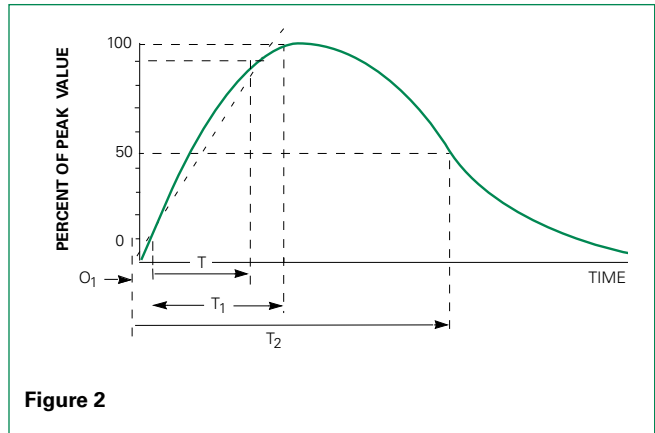

Figure 2

O_1 = Virtual Origin of Wave

T = Time from 10% to 90% of Peak

T_1 = Rise Time = $1.25 \times T$

T_2 = Decay Time

Example - For an $8/20 \mu s$ Current Waveform:

$8 \mu s = T_1$ = Rise Time

$20 \mu s = T_2$ = Decay Time

Limit V-I Characteristic for V5.5MLA0402 to V18MLA0402

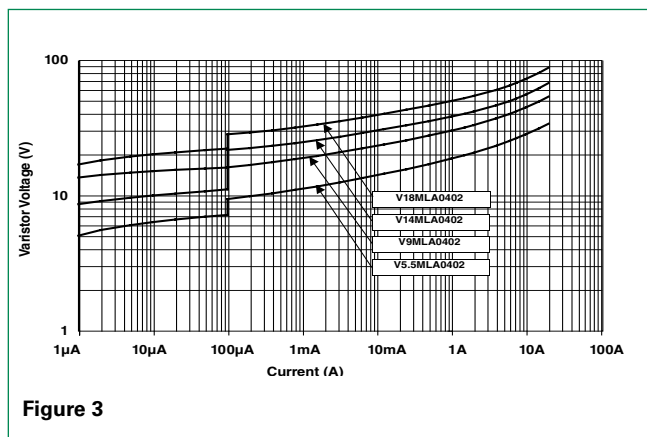

Figure 3

Limit V-I Characteristic for V9MLA0402L

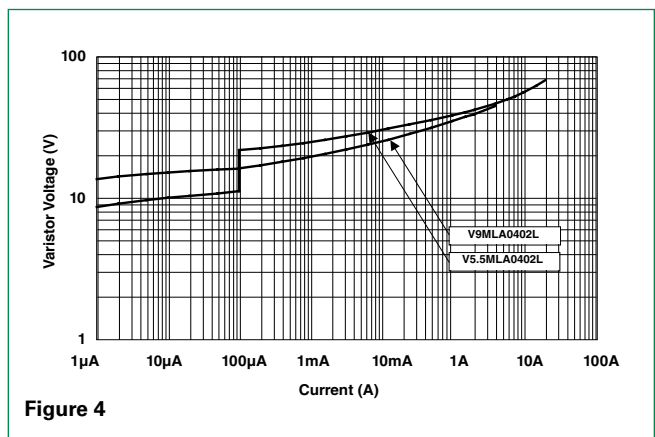

Figure 4

MLA Varistor Series

Surface Mount Multilayer Varistors (MLVs)

Limit V-I Characteristic for V3.5MLA0603 to V30MLA0603

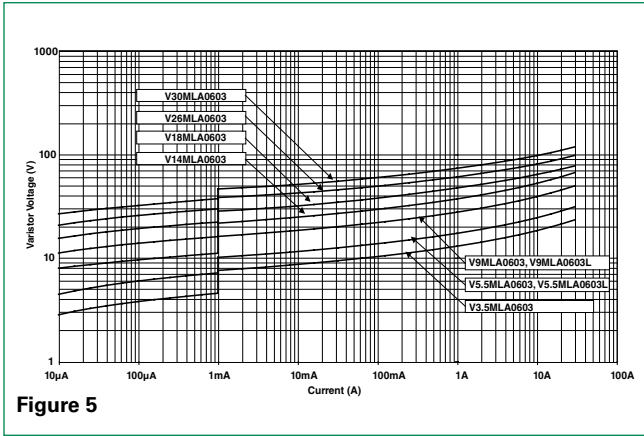

Figure 5

Limit V-I Characteristic for V3.5MLA0805L to V30MLA0805L

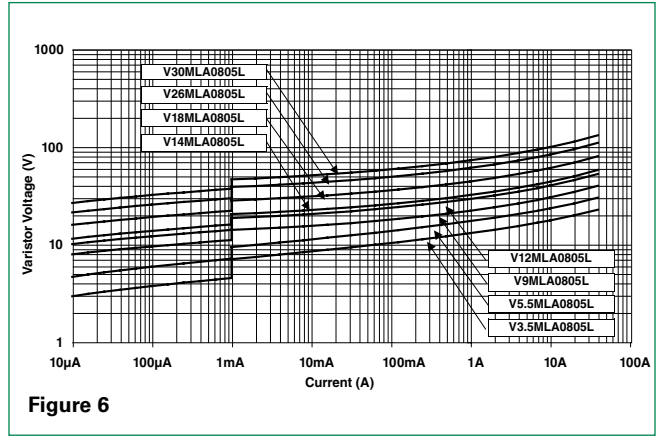

Figure 6

Limit V-I Characteristic for V3.5MLA0805 to V26MLA0805

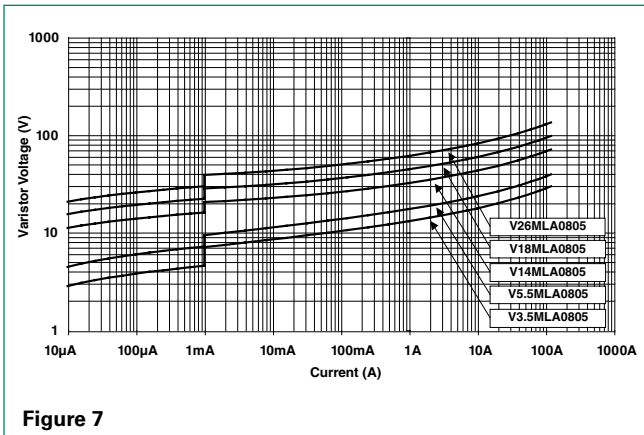

Figure 7

Limit V-I Characteristic for V3.5MLA1206 to V68MLA1206

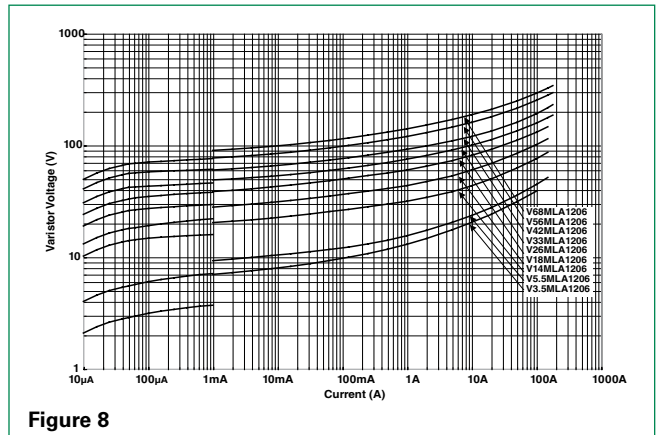

Figure 8

Limit V-I Characteristic for V18MLA1210 to V120MLA1210

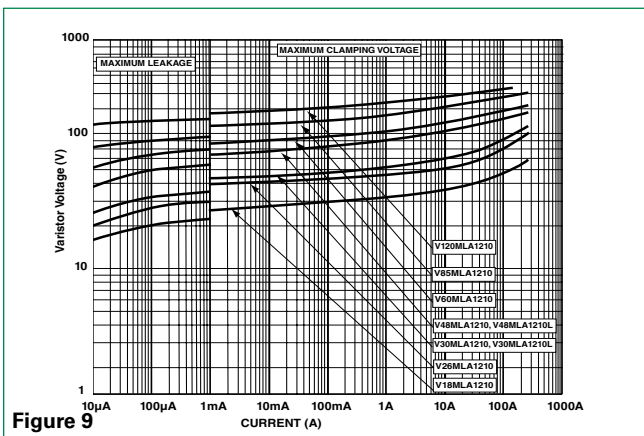

Figure 9

MLA Varistor Series

Surface Mount Multilayer Varistors (MLVs)

Device Characteristics

At low current levels, the V-I curve of the multilayer transient voltage suppressor approaches a linear (ohmic) relationship and shows a temperature dependent effect. At or below the maximum working voltage, the suppressor is in a high resistance mode (approaching 106Ω at its maximum rated working voltage). Leakage currents at maximum rated voltage are below 100μA, typically 25μA; for 0402 size below 20μA, typically 5μA.

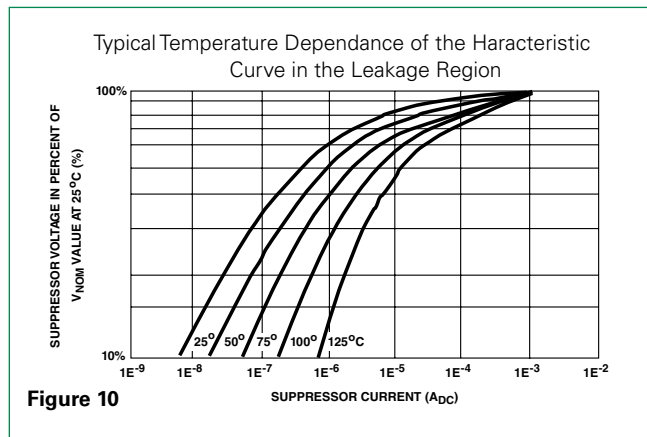

Figure 10

Speed of Response

The Multilayer Suppressor is a leadless device. Its response time is not limited by the parasitic lead inductances found in other surface mount packages. The response time of the ZNO dielectric material is less than 1ns and the MLA can clamp very fast dV/dT events such as ESD. Additionally, in "real world" applications, the associated circuit wiring is often the greatest factor effecting speed of response. Therefore, transient suppressor placement within a circuit can be considered important in certain instances.

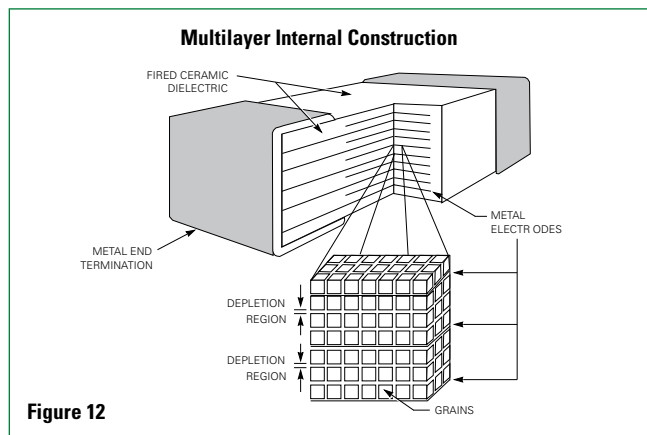

Figure 12

Clamping Voltage Over Temperature (VC at 10A)

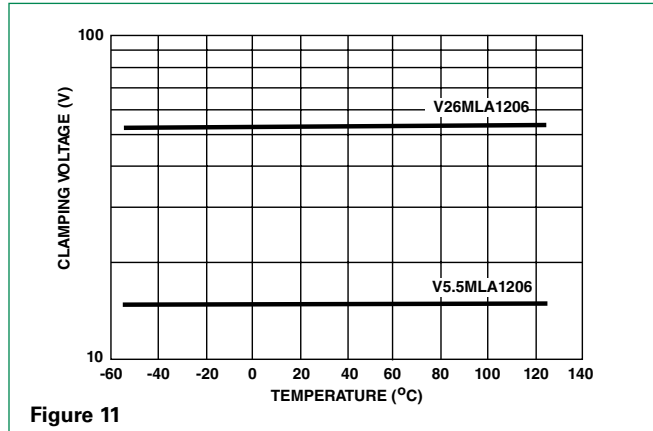

Figure 11

Energy Absorption/Peak Current Capability

Energy dissipated within the MLA Series is calculated by multiplying the clamping voltage, transient current and transient duration. An important advantage of the multilayer is its interdigitated electrode construction within the mass of dielectric material. This results in excellent current distribution and the peak temperature per energy absorbed is very low. The matrix of semiconducting grains combine to absorb and distribute transient energy (heat) (see Speed of Response). This dramatically reduces peak temperature; thermal stresses and enhances device reliability. As a measure of the device capability in energy and peak current handling, the V26MLA1206A part was tested with multiple pulses at its peak current rating (3A, 8/20μs). At the end of the test, 10,000 pulses later, the device voltage characteristics are still well within specification.

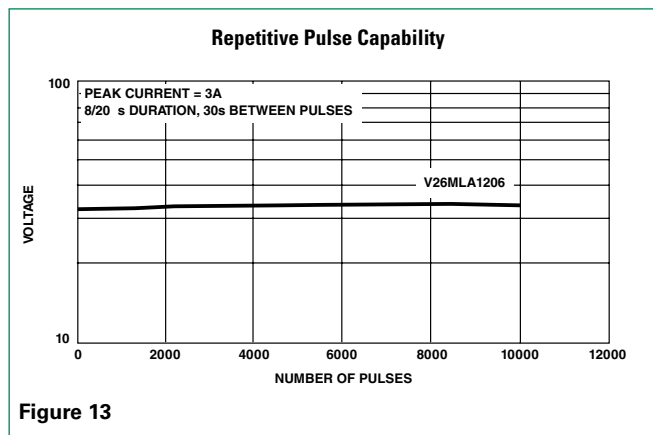

Figure 13

MLA Varistor Series

Surface Mount Multilayer Varistors (MLVs)

Lead (Pb) Soldering Recommendations

The principal techniques used for the soldering of components in surface mount technology are IR Re-flow and Wave soldering. Typical profiles are shown on the right.

The recommended solder for the MLA suppressor is a 62/36/2 (Sn/Pb/Ag), 60/40 (Sn/Pb) or 63/37 (Sn/Pb). Littelfuse also recommends an RMA solder flux.

Wave soldering is the most strenuous of the processes. To avoid the possibility of generating stresses due to thermal shock, a preheat stage in the soldering process is recommended, and the peak temperature of the solder process should be rigidly controlled.

When using a reflow process, care should be taken to ensure that the MLA chip is not subjected to a thermal gradient steeper than 4 degrees per second; the ideal gradient being 2 degrees per second. During the soldering process, preheating to within 100 degrees of the solder's peak temperature is essential to minimize thermal shock.

Once the soldering process has been completed, it is still necessary to ensure that any further thermal shocks are avoided. One possible cause of thermal shock is hot printed circuit boards being removed from the solder process and subjected to cleaning solvents at room temperature. The boards must be allowed to cool gradually to less than 50° C before cleaning.

Reflow Solder Profile

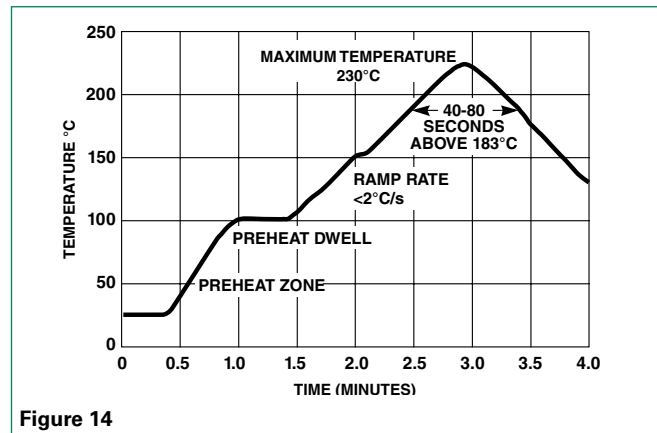

Figure 14

Wave Solder Profile

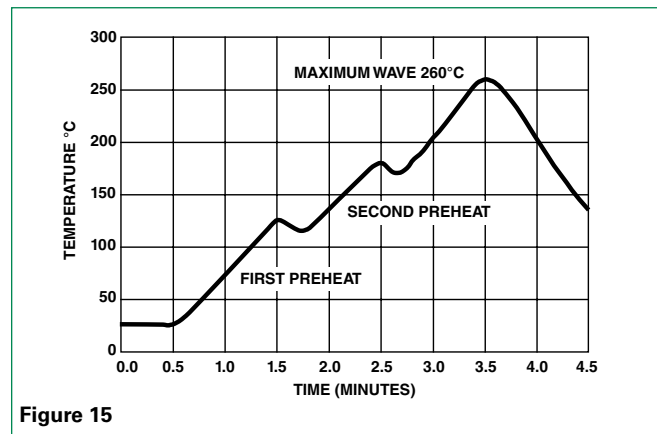

Figure 15

Lead-free (Pb-free) Soldering Recommendations

Littelfuse offers the Nickel Barrier Termination option (see "N" suffix in Part Numbering System for ordering) for the optimum Lead-free solder performance, consisting of a Matte Tin outer surface plated on Nickel underlayer, plated on Silver base metal. The preferred solder is 96.5/3.5 (SnAgCu) with an RMA flux, but there is a wide selection of pastes and fluxes available with which the Nickel Barrier parts should be compatible.

The reflow profile must be constrained by the maximums in the Lead-free Reflow Profile. For Lead-free wave soldering, the Wave Solder Profile still applies.

Note: the Lead-free paste, flux and profile were used for evaluation purposes by Littelfuse, based upon industry standards and practices. There are multiple choices of all three available, it is advised that the customer explores the optimum combination for their process as processes vary considerably from site to site.

Lead-free Re-flow Solder Profile

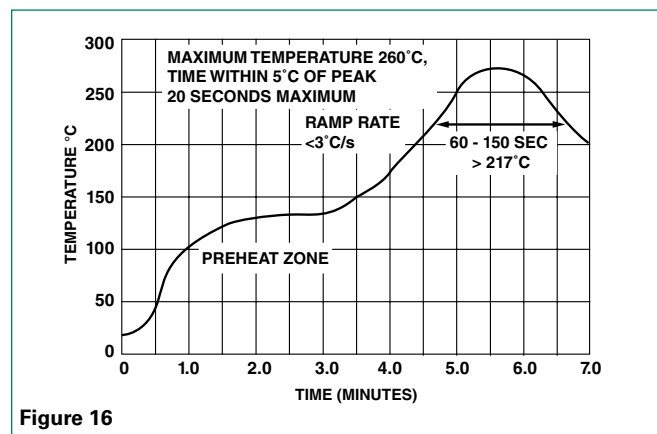
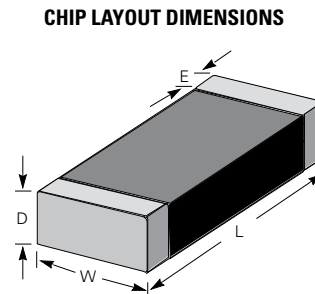
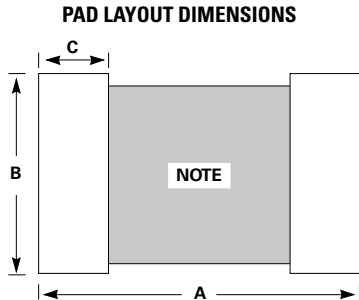

Figure 16

MLA Varistor Series

Surface Mount Multilayer Varistors (MLVs)

Product Dimensions (mm)



Note: Avoid metal runs in this area, parts not recommended for use in applications using Silver (Ag) epoxy paste.

Dimension	1210 Size		1206 Size		0805 Size		0603 Size		0402 Size	
	IN	MM	IN	MM	IN	MM	IN	MM	IN	MM
A	0.160	4.06	0.160	4.06	0.120	3.05	0.100	2.54	0.067	1.70
B	0.100	2.54	0.065	1.65	0.050	1.27	0.030	0.76	0.020	0.51
C	0.040	1.02	0.040	1.02	0.040	1.02	0.035	0.89	0.024	0.61
D (max.)	0.113	2.87	0.071	1.80	0.043	1.10	0.040	1.00	0.024	0.60
E	0.020 -/+0.010	0.50 +/-0.25	0.020 -/+0.010	0.50 +/-0.25	0.020 +/- 0.010	0.50 +/- 0.25	0.015 -/+0.008	0.4 +/-0.20	0.010 -/+0.006	0.25 +/-0.15
L	0.125 -/+0.012	3.20 +/-0.30	0.125 -/+0.012	3.20 +/-0.30	0.079 -/+0.008	2.01 +/-0.20	0.063 -/+0.006	1.6 +/-0.15	0.039 -/+0.004	1.00 +/-0.10
W	0.100 -/+0.012	2.54 +/-0.30	0.060 -/+0.011	1.60 +/-0.28	0.049 -/+0.008	1.25 +/-0.20	0.032 -/+0.060	0.8 +/-0.15	0.020 -/+0.004	0.50 +/-0.10

Part Numbering System

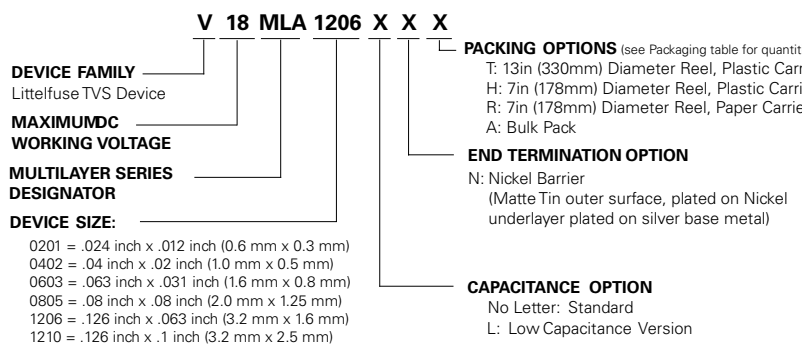

***Notes:**
1 V120MLA1210 standard shipping quantities are 1000 pieces per reel for the "H" option and 4000 pieces per reel for "T" option.
2 V3.5 MLA0603, V5.5MLA0603 and V9MLA0603 only available in "H," "T" and "A" packing options.

Packaging*

Device Size	Quantity			
	13" Inch Reel ("T" Option)	7" Inch Reel ("H" Option)	7" Inch Reel ("R" Option)	Bulk Pack ("A" Option)
1812	4,000	N/A	N/A	N/A
1210	8,000	2,000	N/A	2,000
1206	10,000	2,500	N/A	2,500
0805	10,000	2,500	N/A	2,500
0603	10,000	2,500	4,000	2,500
0402	N/A	N/A	10,000	N/A

*(Packaging) It is recommended that parts be kept in the sealed bag provided and that parts be used as soon as possible when removed from bags.

MLA Varistor Series

Surface Mount Multilayer Varistors (MLVs)

Tape and Reel Specifications

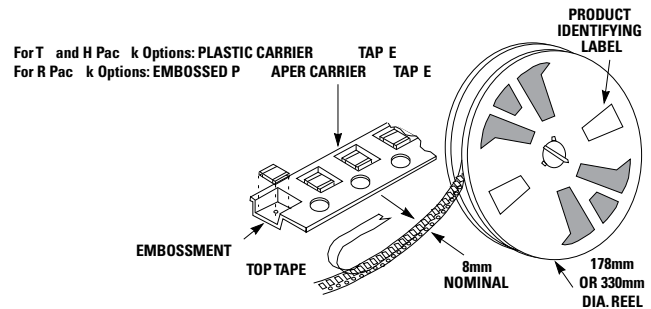
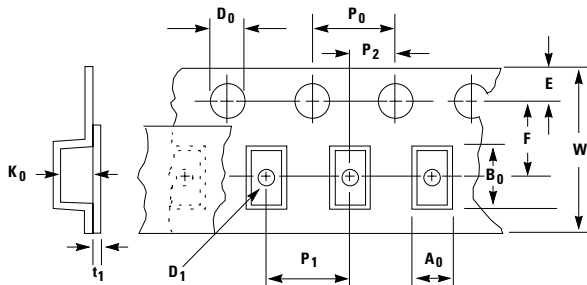

Symbol	Description	Dimensions in Millimeters	
		0402 Size	0603, 0805, 1206 & 1210 Sizes
A_0	Width of Cavity	Dependent on Chip Size to Minimize Rotation.	
B_0	Length of Cavity	Dependent on Chip Size to Minimize Rotation.	
K_0	Depth of Cavity	Dependent on Chip Size to Minimize Rotation.	
W	Width of Tape	8 +/-0.2	8 +/-0.3
F	Distance Between Drive Hole Centers and Cavity Centers	3.5 +/-0.05	3.5 +/-0.05
E	Distance Between Drive Hole Centers and Tape Edge	1.75 +/-0.1	1.75 +/-0.1
P_1	Distance Between Cavity Centers	2 +/-0.05	4 +/-0.1
P_2	Axial Drive Distance Between Drive Hole Centers & Cavity Centers	2 +/-0.1	2 +/-0.1
P_0	Axial Drive Distance Between Drive Hole Centers	4 +/-0.1	4 +/-0.1
D_0	Drive Hole Diameter	1.55 +/-0.05	1.55 +/-0.05
D_1	Diameter of Cavity Piercing	N/A	1.05 +/-0.05
T_1	Top Tape Thickness	0.1 Max	0.1 Max

Notes:

- Conforms to EIA-481-1, Revision A
- Can be supplied to IEC publication 286-3

Disclaimer Notice - Information furnished is believed to be accurate and reliable. However, users should independently evaluate the suitability of and test each product selected for their own applications. Littelfuse products are not designed for, and may not be used in, all applications. Read complete Disclaimer Notice at www.littelfuse.com/disclaimer-electronics.