

P	LTR	DESCRIPTION	DATE	DMN	APVD
-	-	SEE SHEET 1	-	-	-

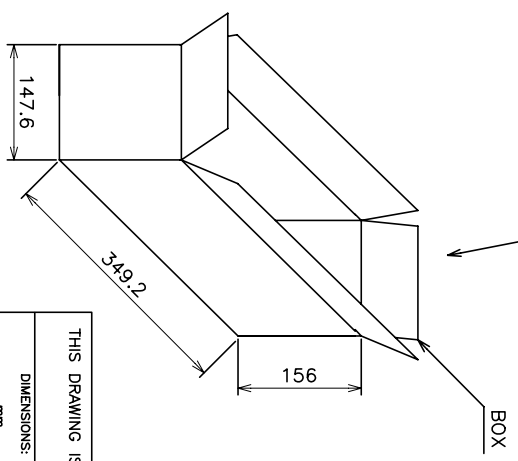
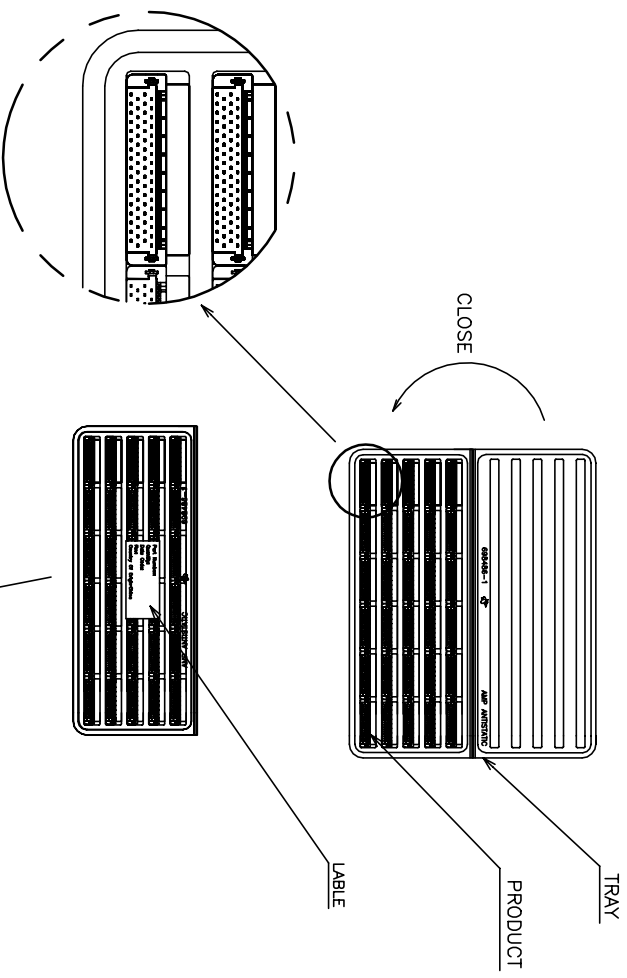

POS.	QTY/ TRAY	TRAY/ BOX	QTY/ BOX	N/W (KG)	G/W (KG)	PART NUMBER
40	45	10	450	1.71	2.66	5-1734099-4
						6-1734099-8
						3-1734099-8
						1-1734099-8
						5-1734099-6
						3-1734099-6
						1-1734099-6
						3-1734099-4
						1-1734099-4
						5-1734099-2
						3-1734099-2
						1-1734099-2
						4-1734099-7
						2-1734099-7
						1734099-7
						4-1734099-6
						2-1734099-6
						1734099-6
						4-1734099-5
						2-1734099-5
						1734099-5
						4-1734099-4
						2-1734099-4
						1734099-4

THIS DRAWING IS A CONTROLLED DOCUMENT.

DIMENSIONS:	TOLERANCES UNLESS OTHERWISE SPECIFIED:
0 P/C	±
1 P/C	±
2 P/C	±
3 P/C	±
4 P/C	±
ANGLES	±

DMN	CHK	APVD	PRODUCT SPEC	APPLICATION SPEC	WEIGHT
-	-	-	-	-	-

STE TE Connectivity

PLUG ASSEMBLY, R/A,
BTB, CHAMP .050, SERIES I

NAME	SIZE	QAGE CODE	DRAWING NO	RESTRICTED TO
A3	00779	1734099		

REVISIONS					
P	LTR	DESCRIPTION	DATE	DMN	APVD
-	-	SEE SHEET 1	-	-	-

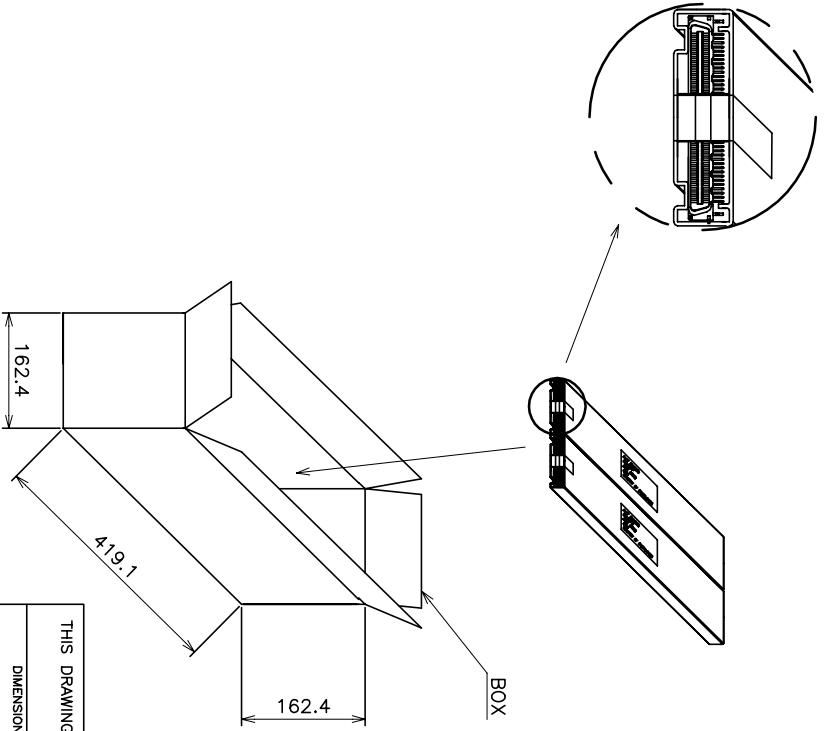
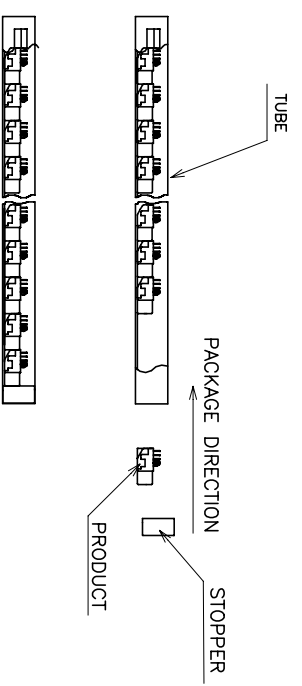

QTY/ TUBE	TUBE/ BOX	QTY/ BOX	N/W (KG)	G/W (KG)	PART NUMBER	
100	21	16	3.36	2.60	3.44	5-1734099-0
80	21	16	3.36	2.15	3.00	3-1734099-0
						1-1734099-0
						4-1734099-8
						2-1734099-8
						1734099-8

THIS DRAWING IS A CONTROLLED DOCUMENT.

DIMENSIONS:	mm	0 P/C	±
		1 P/C	±
		2 P/C	±
		3 P/C	±
		4 P/C	±
ANGLES			±
FINISH			
MATERIAL			

DMN	-
CHK	-
APVD	-
PRODUCT SPEC	-
APPLICATION SPEC	-
WEIGHT	-
CUSTOMER DRAWING	-

STE TE Connectivity

PLUG ASSEMBLY, R/A,
BTB, CHAMP .050, SERIES I

NAME: _____

SIZE: A3

CAGE CODE: 00779

DRAWING NO: 1734099

RESTRICTED FOR: _____

SCALE: _____ SHEET: 4 OF 5 REV: H1

REVOLUTIONS		DATE	DMN	APVD
P	LIR			
		SEE SHEET 1		

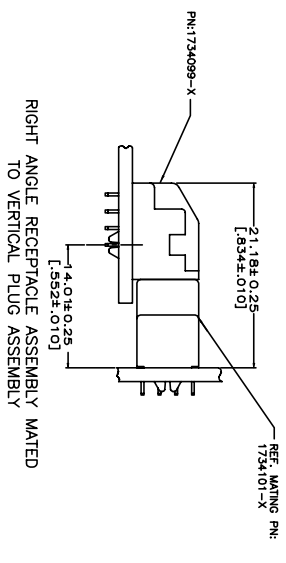
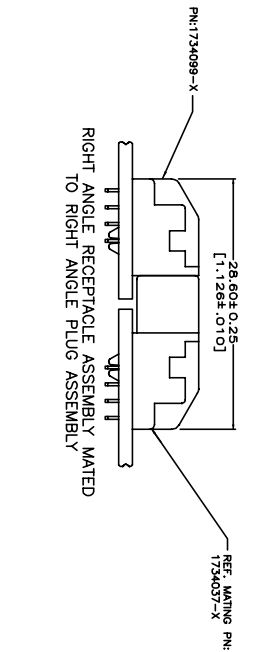
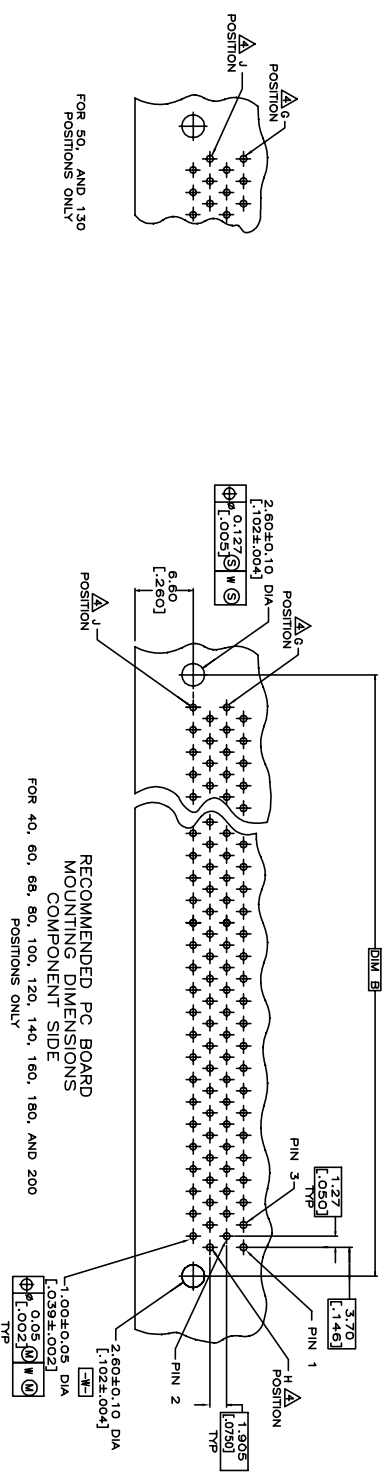

THIS DRAWING IS A CONTROLLED DOCUMENT.		DMN	
DIMENSIONS: mm		CHK	
TOLERANCES UNLESS OTHERWISE SPECIFIED:		APVD	
0 P/C	±	PRODUCT SPEC	
1 P/C	±		
2 P/C	±	APPLICATION SPEC	
3 P/C	±		
4 P/C	±	WEIGHT	
ANGLES	±		
FINISH			
MATERIAL			
NAME		SIZE	QAGE CODE
STE TE Connectivity		A3	00779
PLUG ASSEMBLY, R/A,		DRAWING NO	1734099
BTB, CHAMP .050, SERIES I		RESTRICTED TO	
CUSTOMER DRAWING		SCALE	SHEET
			3 OF 5
		REV	H1