

Standard Fixed Output LDO Regulator Series

Standard Fixed Output LDO Regulators



BA□□DD0 Series, BA□□CC0 Series

Standard Fixed Output LDO Regulators with Shutdown Switch

BA□□DD0W and,BA□□CC0W Series

No.10021EBT01

●General Description

Standard Fixed Output LDO Regulators are low-saturation regulators, available for output s up to 2A/1A. ROHM has a wide output voltage range and package lineup with and without shutdown switches. This IC has a built-in over-current protection circuit that prevents the destruction of the IC due to output short circuits, a thermal shut-down circuit that protects the IC from damage due to overloading and an over-voltage protection circuit that protects the IC from surges generated in the power supply line of the IC.

●Features

- 1) Maximum output current : 2A (BA□□DD0),1A(BA□□CC0)
- 2) ±1% highly accurate output voltage (BA□□DD0)
- 3) Low saturation with PNP output
- 4) Built-in over-current protection circuit that prevents the destruction of the IC due to output short circuits
- 5) Built-in thermal shutdown circuit for protecting the IC from damage due to overloading
- 6) Built-in over- voltage protection circuit that prevents the destruction of the IC due to power supply surges
- 7) TO220FP and HRP5 packaging (BA□□DD0) ,TO220FP and TO252 packaging(BA□□CC0)

●Applications

Used in DSP power supplies for DVD and CD players, FPDs, televisions, personal computers or any other consumer device

●Line up

1A BA□□CC0 Series

Part Number	3.0	3.3	5.0	6.0	7.0	8.0	9.0	10	12	15	Package
BA□□CC0WT	○	○	○	—	○	○	○	○	○	—	TO220FP-5
BA□□CC0WT-V5	—	○	○	—	—	○	○	—	○	—	TO220FP-5(V5)
BA□□CC0WFP	—	○	○	○	○	○	○	—	○	—	TO252-5
BA□□CC0T	○	○	○	○	○	○	○	○	○	○	TO220FP-3
BA□□CC0FP	○	○	○	○	○	○	○	○	○	○	TO252-3

2A BA□□DD0 Series

Part Number	1.5	1.8	2.5	3.0	3.3	5.0	9.0	12	16	Package
BA□□DD0WT	○	○	○	○	○	○	○	○	○	TO220FP-5
BA□□DD0WHFP	○	○	○	○	○	○	○	○	○	HRP5
BA□□DD0T	○	○	○	○	○	○	○	○	○	TO220FP-3

Part Number : BA□□CC0□□
a b c

Part Number : BA□□DD0□□
a b c

Symbol	Details			
a	Output Voltage Designation			
	□□	Output Voltage(V)	□□	Output Voltage(V)
	03	3.0V(Typ.)	08	8.0V(Typ.)
	033	3.3V(Typ.)	09	9.0V(Typ.)
	05	5.0V(Typ.)	J0	10.0V(Typ.)
	06	6.0V(Typ.)	J2	12.0V(Typ.)
	07	7.0V(Typ.)	J5	15.0V(Typ.)
b	Switch:"With W" :Shutdown switch included "Without W" :Shutdown switch not included			
c	Package T : TO220FP-5(V5),TO220FP-3 FP : TO252-5,TO252-3			

Symbol	Details			
a	Output Voltage Designation			
	□□	Output Voltage(V)	□□	Output Voltage(V)
	15	1.5V(Typ.)	50	5.0V(Typ.)
	18	1.8V(Typ.)	90	9.0V(Typ.)
	25	2.5V(Typ.)	J2	12.0V(Typ.)
	30	3.0V(Typ.)	J6	16.0V(Typ.)
	33	3.3V(Typ.)		
b	Switch:"With W" :Shutdown switch included "Without W" :Shutdown switch not included			
c	Package T : TO220FP-5,TO220FP-3 HFP: HRP5			

●Absolute Maximum Ratings(Ta=25°C)

Parameter	Symbol	Limits	Unit
Input Power Supply Voltage	Vcc	-0.3~+35	V
Power Dissipation	Pd	2300(HRP5)	mW
		1300(TO252-5)	
		1200(TO252-3)	
		2000(TO220FP-3,5)	
Operating Temperature Range	Topr	-40~+125	°C
Ambient Storage Temperature	Tstg	-55~+150	°C
Junction Temperature	Tjmax	+150	°C
Output Control Terminal Voltage	VCTL	-0.3~+Vcc	V
Voltage Applied to the Tip	Vcc peak	+50	V

*1 Must not exceed Pd

*2 HRP5 : In cases in which Ta≥25°C when a 70mm×70mm×1.6mm glass epoxy board is used, the power is reduced by 18.4 mW/°C.

TO252FP-3 : In cases in which Ta≥25°C when a 70mm×70mm×1.6mm glass epoxy board is used, the power is reduced by 9.6 mW/°C.

TO252FP-5 : In cases in which Ta≥25°C when a 70mm×70mm×1.6mm glass epoxy board is used, the power is reduced by 10.4 mW/°C.

TO220FP-5 : No heat sink. When Ta≥25°C, the power is reduced by 16 mW/°C.

*3 Only for models with shutdown switches.

*4 Applied voltage : 200msec or less (tr≥1msec)

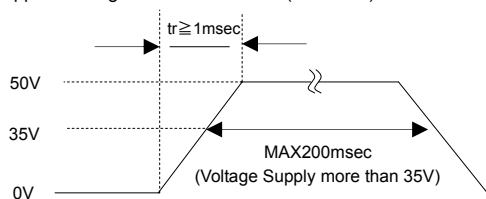

●Recommended Operating Range (Ta=25°C)

Parameter	Symbol	Min.	Max.	Unit
Input PowerSupply Voltage	Vcc	4.0	25.0	V
		3.0	25.0	
Output Current	Io	—	1	A
		—	2	
Output Control Terminal Voltage	VCTL	0	Vcc	V

●Electrical Characteristics(ABRIDGED)

BA□□CC0 Series (unless specified otherwise, Ta=25°C, VCTL=5.0V(only with switch), Io=500mA,and Vcc= VccD^{*5})

Parameter	Symbol	Min.	Typ.	Max.	Unit	Conditions
Output Voltage	Vo	Vo × 0.98	Vo	Vo × 1.02	V	Refer to the lineup for Vo
Circuit Current at Shutdown	Isd	—	0	10	μA	VCTL=0V
Minimum I/O Difference	Vd	—	0.3	0.5	V	Vcc= 0.95 × Vo
Output Current Capacity	Io	1.0	—	—	A	
Input Stability	Reg.I	—	20	100	mV	Vcc= (Vo+1)V → 25V
Load Stability	Reg.L	—	50	100	mV	Io=5mA→1A
Output Voltage Temperature Coefficient ^{*6}	Tcvo	—	±0.02	—	%/°C	Io=5mA ,Tj=0~125°C

BA00DD0□□ series (unless specified otherwise, Ta=25°C, VCTL=3V(only with switch), Io=500mA,and Vcc=VccD^{*7})

Parameter	Symbol	Min.	Typ.	Max.	Unit	Conditions
Output Voltage	Vo	Vo × 0.99	Vo	Vo × 1.01	V	Io=200mA
Circuit Current at Shutdown	Isd	—	0	10	μA	VCTL=0V
Minimum I/O Difference	Vd	—	0.45	0.7	V	Vcc= 0.95 × Vo, Io=2A
Output Current Capacity	Io	2.0	—	—	A	
Input Stability	Reg.I	—	15	50	mV	Vcc= VccD ^{*7} →25V, Io=200mA
Load Stability	Reg.L	—	50	200	mV	Io=5mA→2A
Output Voltage Temperature Coefficient ^{*6}	Tcvo	—	±0.02	—	%/°C	Io=5mA ,Tj=0~125°C

*5 Vo=3.0V : Vcc= 8.0V , Vo=3.3V : Vcc=8.3V , Vo=5.0V : Vcc=10.0V , Vo=6.0V : Vcc=11.0V , Vo=7.0V : Vcc=12.0V,

Vo=8.0V : Vcc= 13.0V , Vo=9.0V : Vcc=14.0V , Vo=10.0V : Vcc=15.0V , Vo=12.0V : Vcc=17.0V , Vo=15.0V : Vcc=20.0V

*6 Design guarantee(100% shipping inspection not performed)

*7 Vo=1.5V , 1.8V , 2.5V , 3.0V : Vcc=4.0V , Vo=3.3V , 5.0V : Vcc=7.0V , Vo=9.0V : Vcc=12.0V ,Vo=12V : Vcc=14V , Vo=16V : Vcc=18V

●Reference Data

BA□□CC0□□(BA33CC0WT)(Unless specified otherwise, Vcc=8.3V, Vo=3.3V, VCTL=5.0V, and Io=0mA)

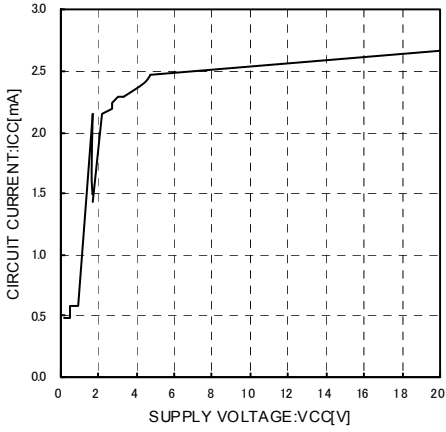

Fig.1 Circuit current

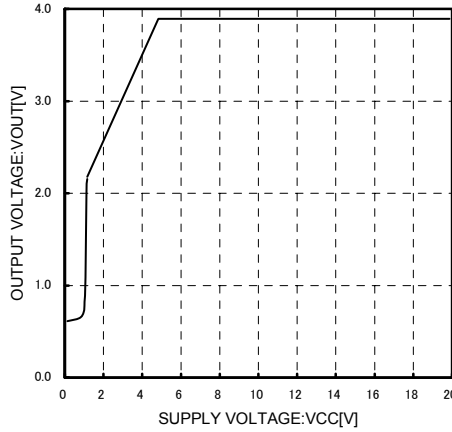

Fig.2 Input Stability

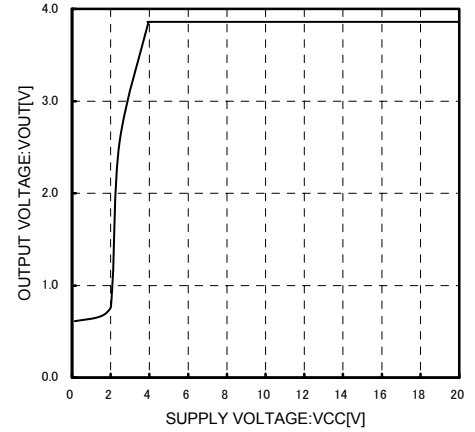

Fig.3 Input Stability(Io=500mA)

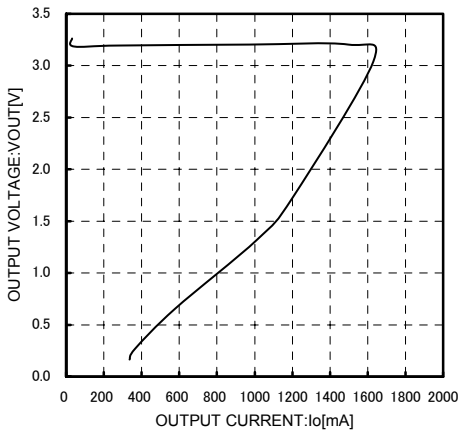

Fig.4 Load Stability

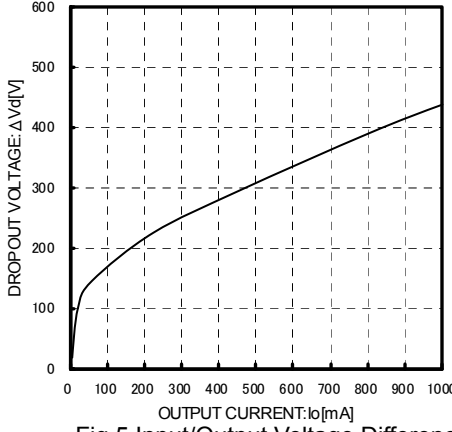

Fig.5 Input/Output Voltage Difference
IOUT (0V=1A)

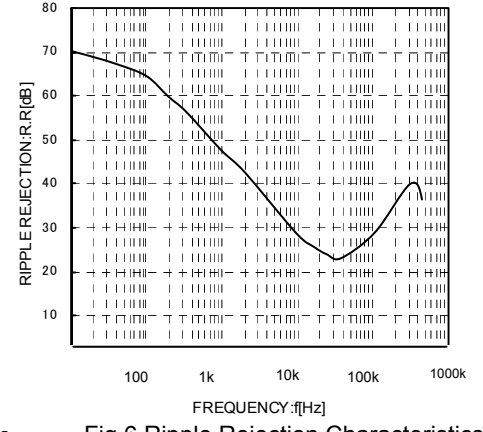

Fig.6 Ripple Rejection Characteristics
(Io=100mA)

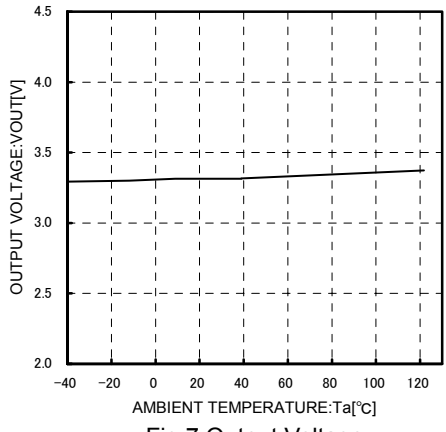

Fig.7 Output Voltage
Temperature Characteristics

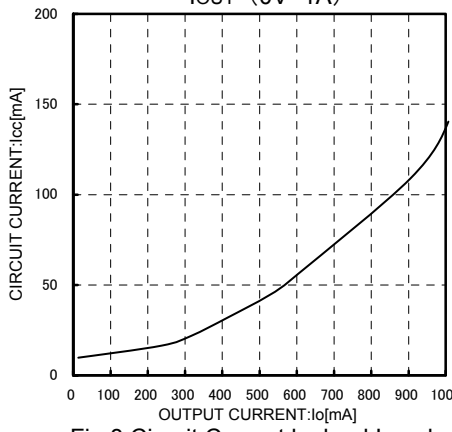

Fig.8 Circuit Current by load Level
(IOUT=0mA→1A)

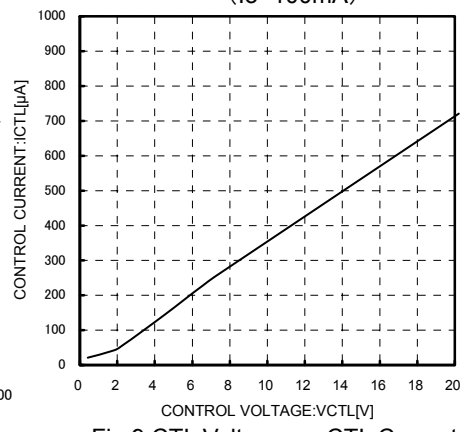

Fig.9 CTL Voltage vs. CTL Current

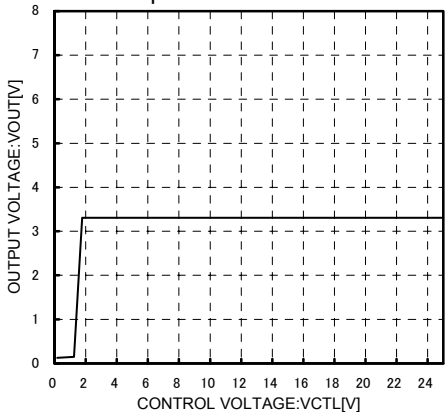

Fig.10 CTL Voltage vs. Output Voltage

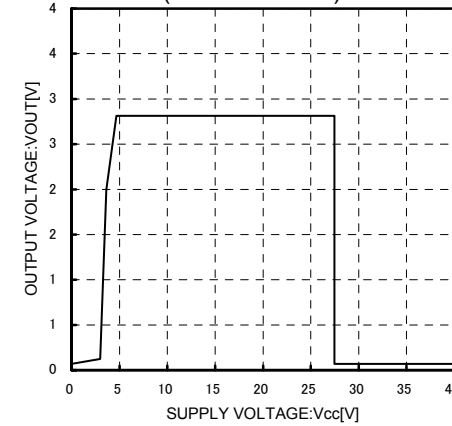

Fig.11 Overvoltage Operating
Characteristics(Io=200mA)

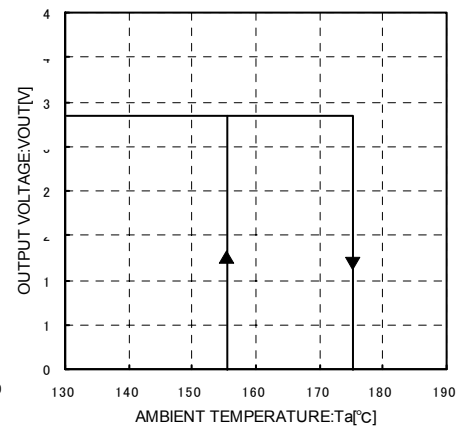

Fig.12 Thermal Shutdown
Circuit Characteristics

●Reference Data

BA□□DD0□□(BA50DD0WT) (Unless specified otherwise, $V_{CC}=7.0V$, $V_o=5.0V$, $V_{CTL}=3.0V$, and $I_o=0mA$)

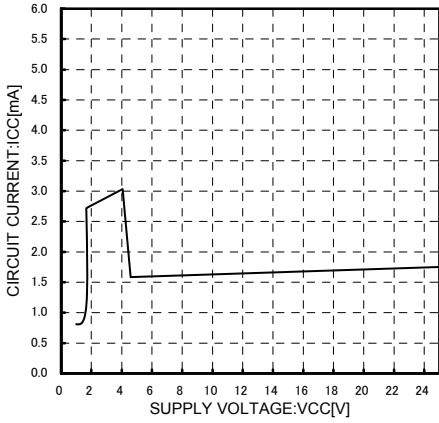

Fig.13 Circuit Current

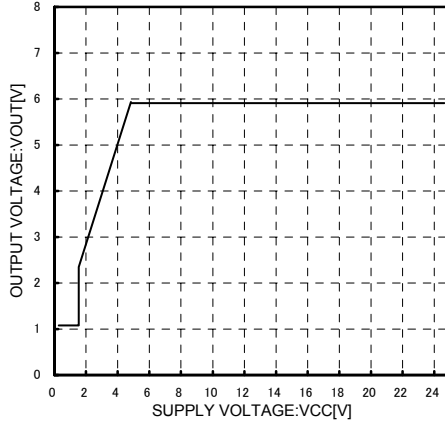

Fig.14 Input Stability

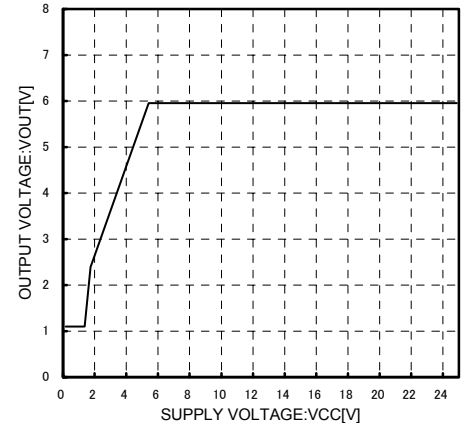

Fig.15 Input Stability ($I_o=2A$)

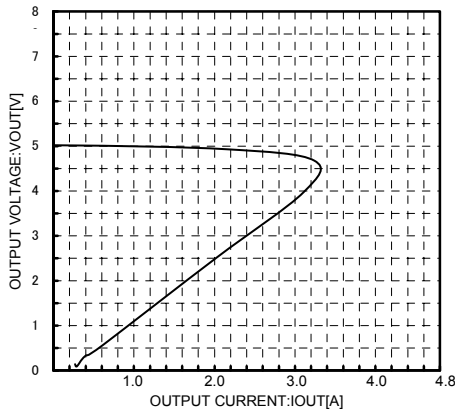

Fig.16 Load Stability

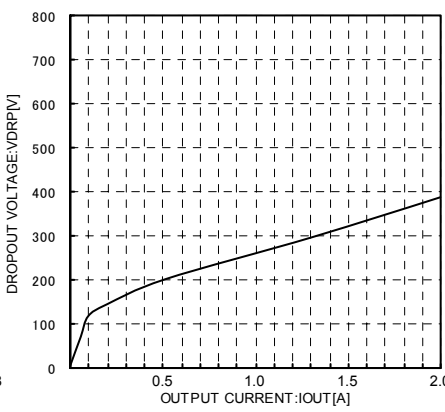

Fig.17 Input/Output Voltage Difference ($V_{CC}=4.75V$)

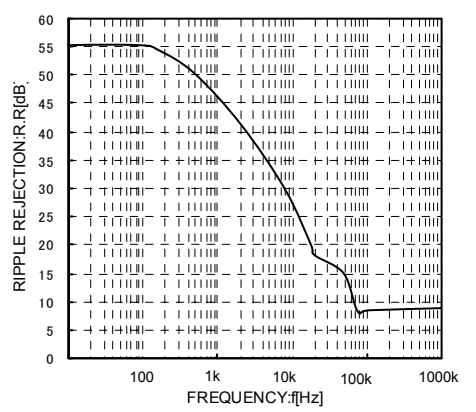

Fig.18 Ripple Rejection Characteristics ($I_o=100mA$)

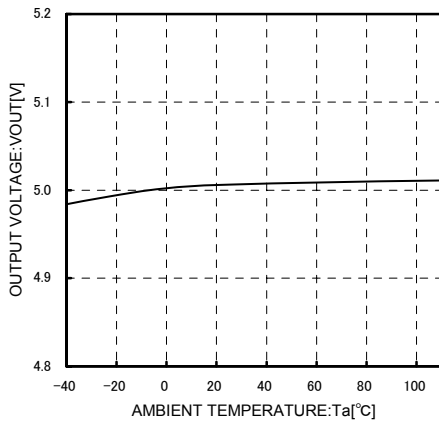

Fig.19 Output Voltage Temperature Characteristics

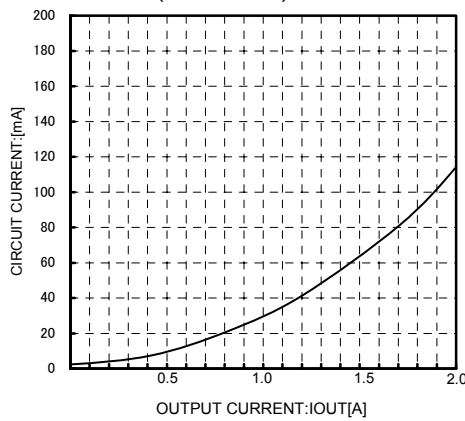

Fig.20 Circuit Current by Load Level ($I_o=0mA \rightarrow 2A$)

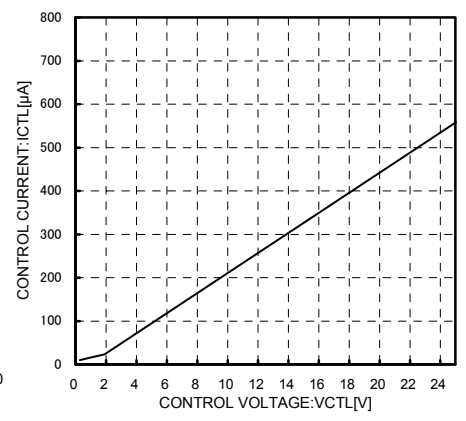

Fig.21 CTL Voltage vs. CTL Current

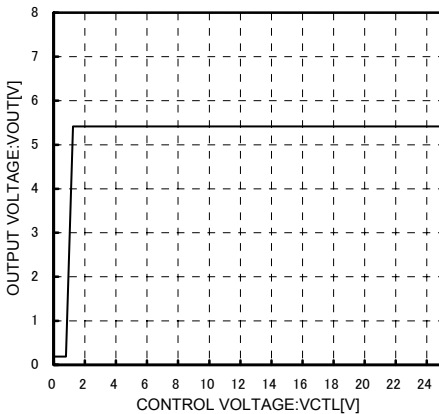

Fig.22 CTL Voltage vs. Output Voltage

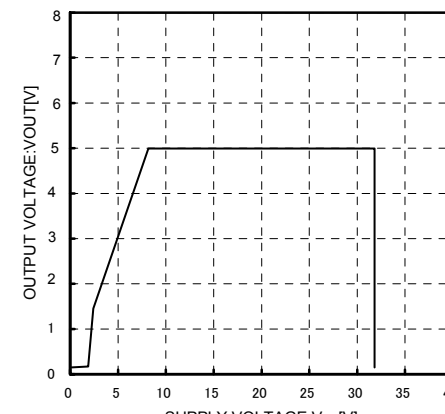

Fig.23 Overvoltage Operating

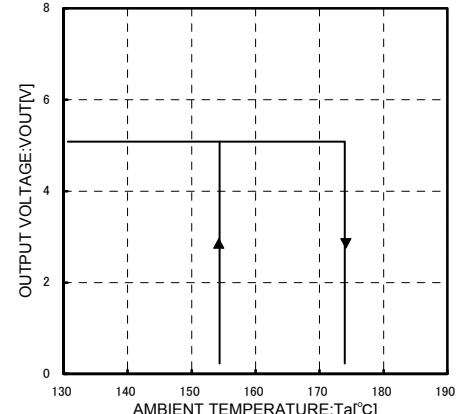
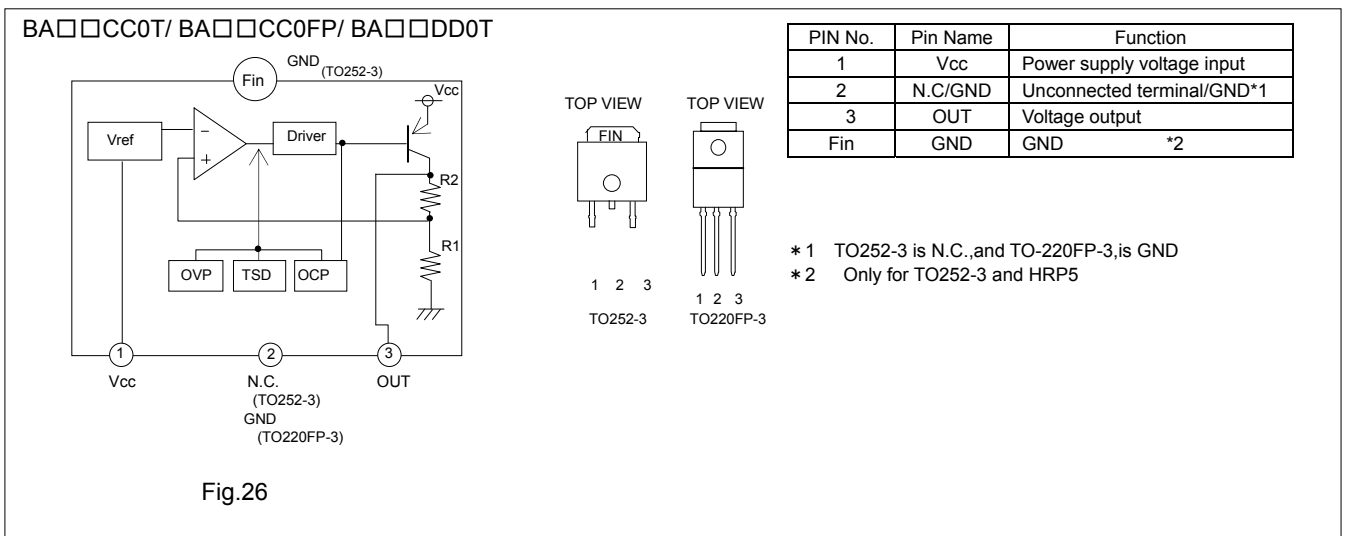
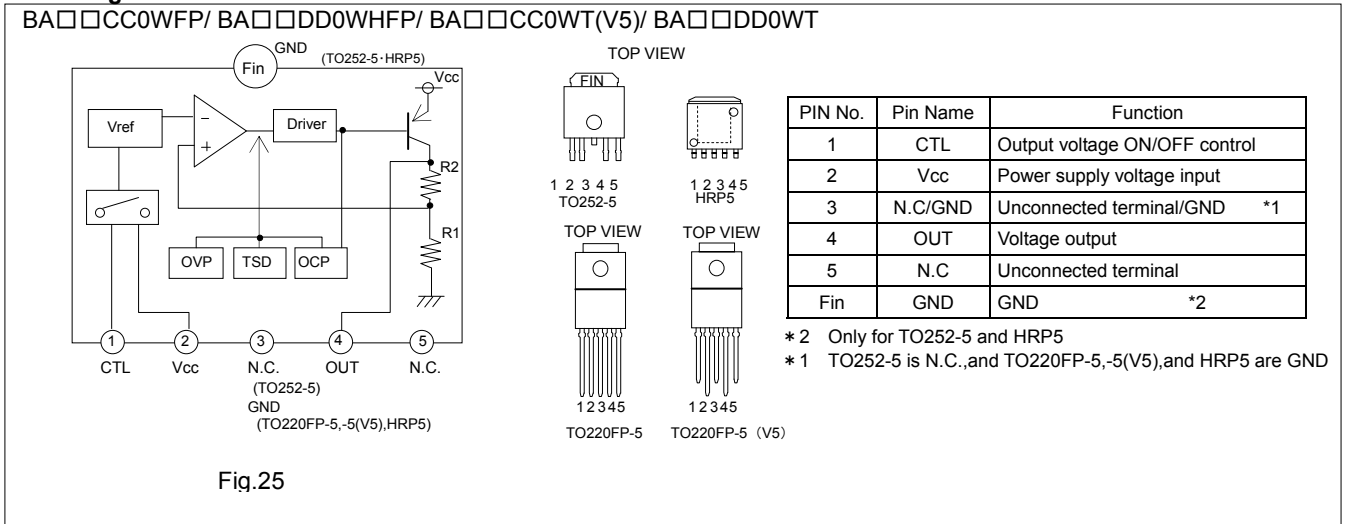

Fig.24 Thermal Shutdown Circuit Characteristics

●Block Diagrams



●Input / Output Equivalent Circuit Diagrams

< BA□□DD0 Series >

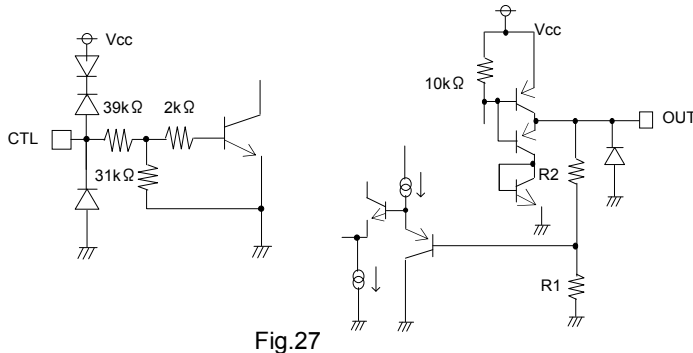

< BA□□CC0 Series >

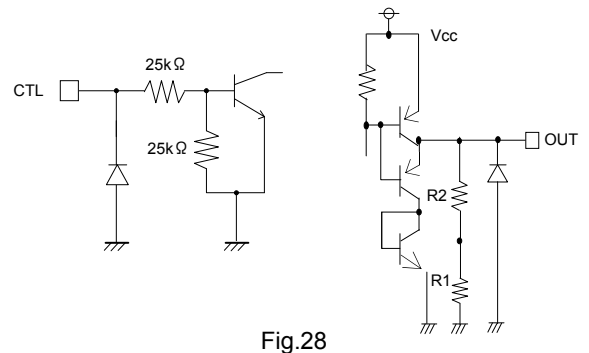

● Thermal Design

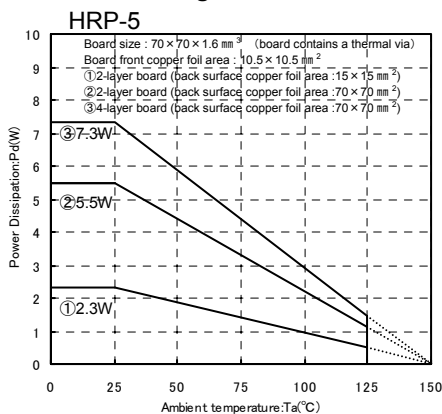

Fig.29

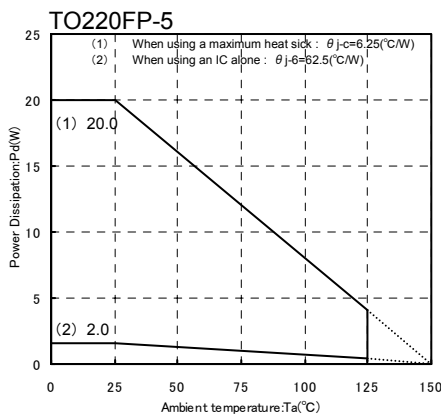

Fig.30

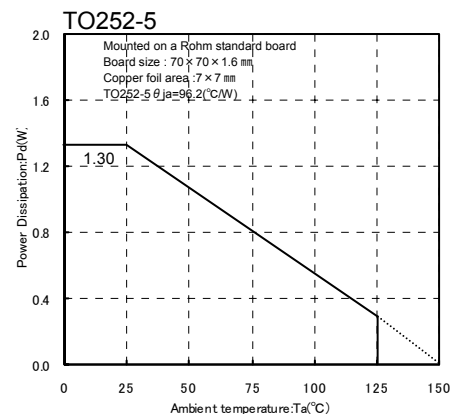

Fig.31

When using at temperatures over $T_a=25^{\circ}\text{C}$, please refer to the heat reducing characteristics shown in Fig.29 through 31. The IC characteristics are closely related to the temperature at which the IC is used and if the temperature exceeds the maximum junction temperature $T_{j\text{MAX}}$, the elements may be damaged or destroyed. From the standpoints of instantaneous destruction and long-term operating reliability, it is necessary give sufficient consideration to IC heat. In order to protect the IC from thermal damage, it is necessary to operate it at temperatures lower than the maximum junction temperature $T_{j\text{MAX}}$ of the IC.

Fig.30 shows the acceptable loss and heat reducing characteristics of the TO220FP package. The portion shown by the diagonal line is the acceptable loss range that can be used with the IC alone. Even when the ambient temperature T_a is a normal temperature (25°C), the chip (junction) temperature T_j may be quite high so please operate the IC at temperatures less than the acceptable loss P_d .

The method of calculating the power consumption $P_c(\text{W})$ is as follows.

$$P_c = (V_{cc}-V_o) \times I_o + V_{cc} \times I_{cca}$$

Acceptable loss $P_d \leq P_c$

V_{cc} : Input voltage
 V_o : Output voltage
 I_o : Load current
 I_{cca} : Circuit current

Solving this for load current I_o in order to operate within the acceptable loss:

$$I_o \leq \frac{P_d - V_{cc} \times I_{cca}}{V_{cc} - V_o}$$

(Please refer to Figs.8 and 20 for I_{cca} .)

It is then possible to find the maximum load current $I_{o\text{MAX}}$ with respect to the applied voltage V_{cc} at the time of thermal design.

• Calculation Example

Example 1) When $T_a=85^{\circ}\text{C}$, $V_{cc}=8.3\text{V}$, $V_o=3.3\text{V}$, BA33DD0WT

$$I_o \leq \frac{1.04 - 8.3 \times I_{cca}}{5}$$

$I_o \leq 200\text{mA}$ ($I_{cca} : 2\text{mA}$)

With the IC alone : $\theta_{ja}=62.5^{\circ}\text{C/W} \rightarrow -16\text{mW}/^{\circ}\text{C}$
 $25^{\circ}\text{C} \rightarrow 2000\text{mW} \rightarrow 85^{\circ}\text{C} \rightarrow 1040\text{mW}$

Please refer to the above information and keep thermal designs within the scope of acceptable loss for all operating temperature ranges.

The power consumption P_c of the IC when there is a short circuit (short between V_o and GND) is :

$$P_c = V_{cc} \times (I_{cca} + I_{short})$$

* I_{short} : Short circuit current

● Peripheral Circuit Considerations

• Vcc Terminal

Please attach a capacitor (greater than $0.33 \mu\text{F}$) between the V_{cc} and GND.

The capacitance values will differ depending on the application, so please take this into account when configuring the terminal.

• GND Terminal

Please be sure to keep the set ground and IC ground at the same potential level so that a potential difference does not arise between them.

If a potential difference arises between the set ground and the IC ground, the preset voltage will not be outputted, causing the system to become unstable. Therefore, please reduce the impedance by making the ground patterns as wide as possible and by reducing the distance between the set ground and the IC ground as much as possible.

• CTL Terminal

The CTL terminal is turned ON at 2.0V and higher and OFF at 0.8V and lower within the operating power supply voltage range. The power supply and the CTL terminal may be started up and shut down in any order without problems.

●Vo Terminal

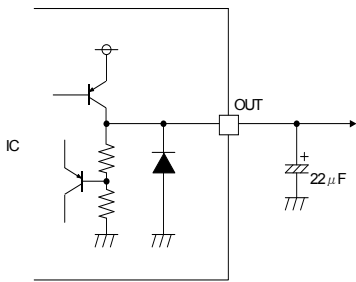

Fig.32 Output Equivalent Circuit

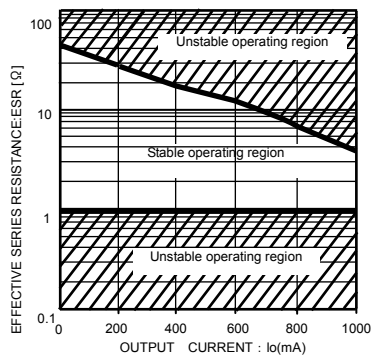

Fig.33 ESR-Io Characteristics
(BA□□CC0)

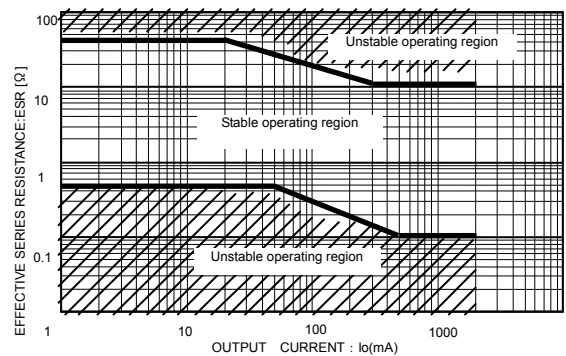

Fig.34 ESR vs Io Characteristics
(BA□□DD0)

Please attach an anti-oscillation capacitor between Vcc and GND. The capacitance of the capacitor may significantly change due to factors such as temperature changes, making it impossible to completely stop oscillations. Please use a tantalum capacitor or aluminum electrolysis capacitor with favorable characteristics and small internal series resistance (ESR) even at low temperatures. The output fluctuates regardless of whether the ESR is large or small. Please use the IC within the stable operating region while referring to the ESR characteristics reference data shown in Figs.32 through 34. In applications where there are sudden load fluctuations, the use of a capacitor with large capacitance is recommended.

●Other Points of Caution

1)Protection Circuits

Over-current Protection Circuit

A built-in over-current protection circuit corresponding to the current capacity prevents the destruction of the IC when there are load shorts. This protection circuit is a “7”-shaped current control circuit that is designed such that the current is restricted and does not latch even when a large current momentarily flows through the system with a high-capacitance capacitor. However, while this protection circuit is effective for the prevention of destruction due to unexpected accidents, it is not suitable for continuous operation or transient use. Please be aware when creating thermal designs that the overcurrent protection circuit has negative current capacity characteristics with regard to temperature (Refer to Figs.4 and 16).

Thermal Shutdown Circuit (Thermal Protection)

This system has a built-in temperature protection circuit for the purpose of protecting the IC from thermal damage.

As shown above, this must be used within the range of acceptable loss, but if the acceptable loss happens to be continuously exceeded, the chip temperature Tj increases, causing the temperature protection circuit to operate.

When the thermal shutdown circuit operates, the operation of the circuit is suspended. The circuit resumes operation immediately after the chip temperature Tj decreases, so the output repeats the ON and OFF states (Please refer to Figs.12 and 24 for the temperatures at which the temperature protection circuit operates).

There are cases in which the IC is destroyed due to thermal runaway when it is left in the overloaded state. Be sure to avoid leaving the IC in the overloaded state.

Reverse Current

In order to prevent the destruction of the IC when a reverse current flows through the IC, it is recommended that a diode be placed between the Vcc and Vo and a pathway be created so that the current can escape (Refer to Fig.35).

2) This IC is bipolar IC that has a P-board (substrate) and P+ isolation layer between each device, as shown in Fig.36. A P-N junction is formed between this P-layer and the N-layer of each device, and the P-N junction operates as a parasitic diode when the electric potential relationship is GND> Terminal A, GND> Terminal B, while it operates as a parasitic transistor when the electric potential relationship is Terminal B GND> Terminal A. Parasitic devices are structurally inevitable in the IC. The operation of parasitic devices induces mutual interference between circuits, causing malfunctions and eventually the destruction of the IC. It is necessary to be careful not to use the IC in ways that would cause parasitic elements to operate. For example, applying a voltage that is lower than the GND (P-board) to the input terminal.

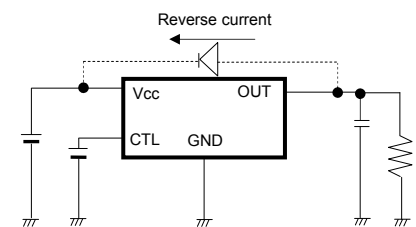

Fig. 36: Bypass diode

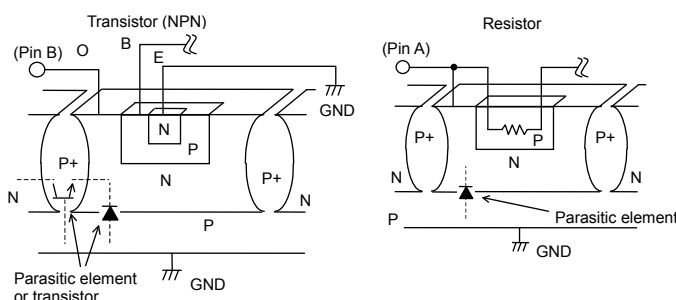
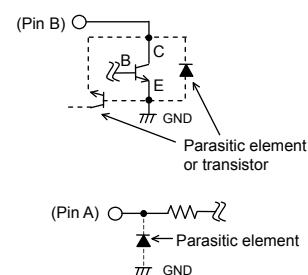

Fig. 37: Example of the basic structure of a bipolar IC



●Ordering part number

B	A	3	3	C	C	0	W	H	F	P	-	T	R
Part No.		Output voltage		Series CC0 : 1A DD0 : 2A			Shutdown switch W : Includes switch	Package HFP : HRP5 FP : TO252-3 TO252-5 T : TO220FP-3 TO220FP-5			Packaging and forming specification TR: Embossed tape and reel (HRP5) E2: Embossed tape and reel (TO252-3, TO252-5) None : Container Tube V5 :Foaming(V5 only)		

HRP5

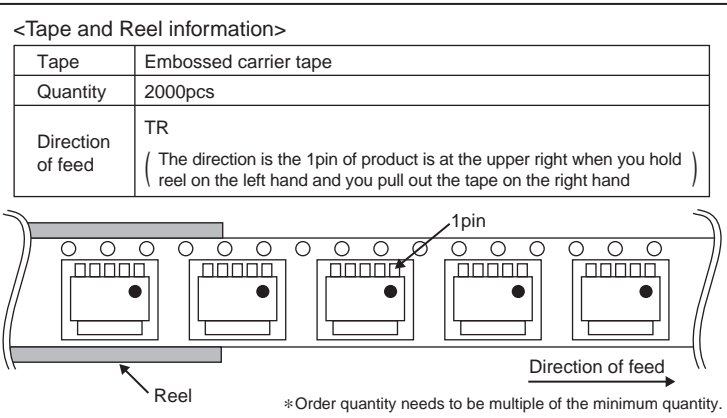
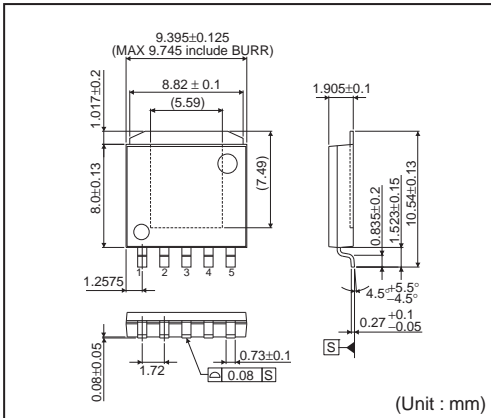

TO252-3

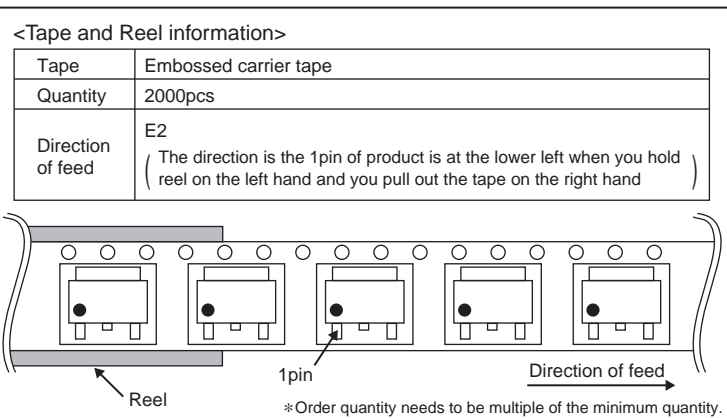
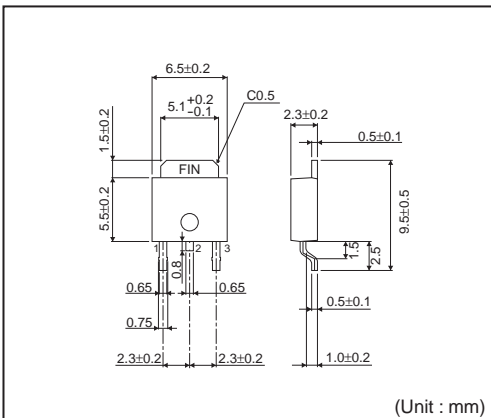

TO252-5

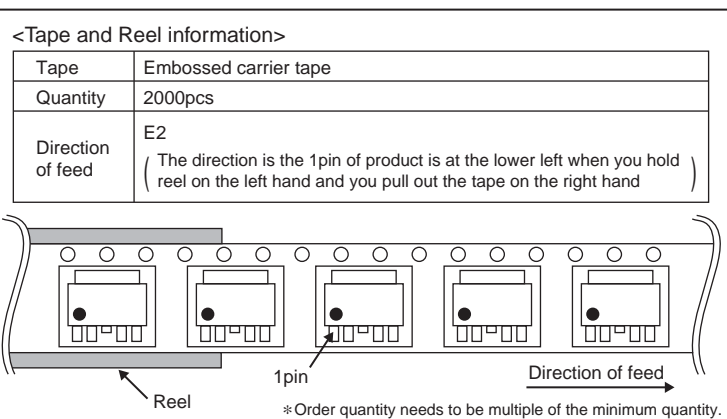
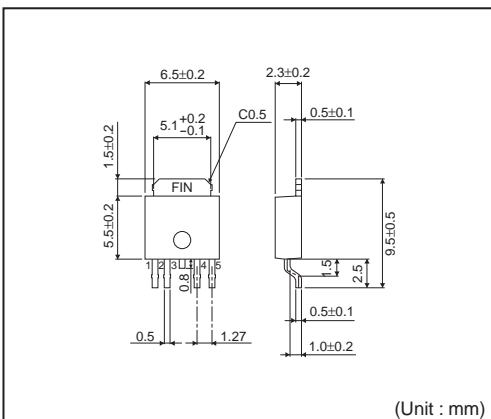

TO220FP-3

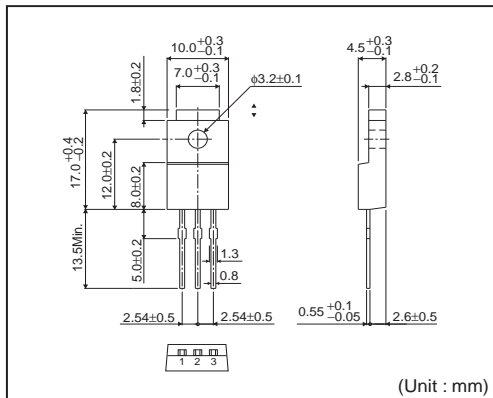

<Tape and Reel information>

Container	Tube
Quantity	500pcs
Direction of feed	Direction of products is fixed in a container tube

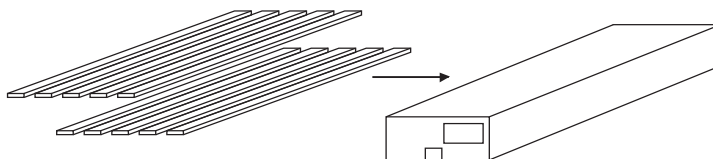

* Order quantity needs to be multiple of the minimum quantity.

TO220FP-5

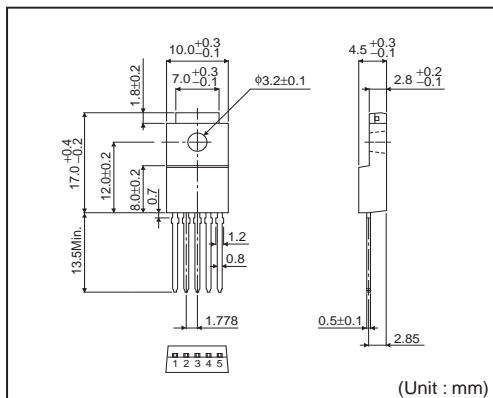

<Tape and Reel information>

Container	Tube
Quantity	500pcs
Direction of feed	Direction of products is fixed in a container tube

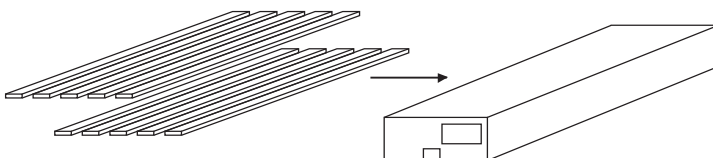

* Order quantity needs to be multiple of the minimum quantity.

TO220FP-5(V5)

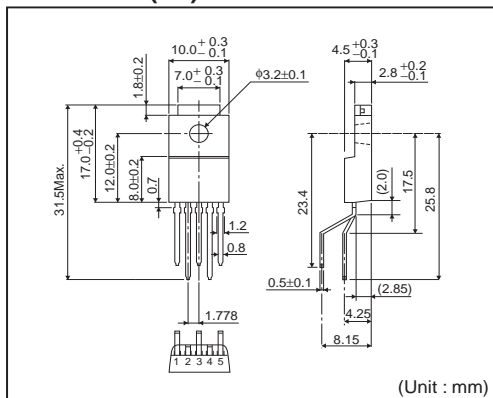

<Tape and Reel information>

Container	Tube
Quantity	500pcs
Direction of feed	Direction of products is fixed in a container tube

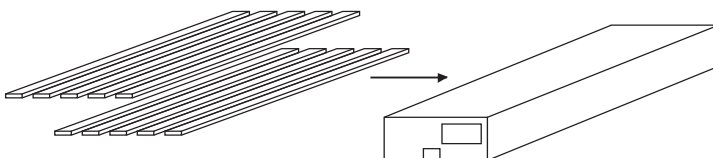

* Order quantity needs to be multiple of the minimum quantity.

Notes

No copying or reproduction of this document, in part or in whole, is permitted without the consent of ROHM Co.,Ltd.

The content specified herein is subject to change for improvement without notice.

The content specified herein is for the purpose of introducing ROHM's products (hereinafter "Products"). If you wish to use any such Product, please be sure to refer to the specifications, which can be obtained from ROHM upon request.

Examples of application circuits, circuit constants and any other information contained herein illustrate the standard usage and operations of the Products. The peripheral conditions must be taken into account when designing circuits for mass production.

Great care was taken in ensuring the accuracy of the information specified in this document. However, should you incur any damage arising from any inaccuracy or misprint of such information, ROHM shall bear no responsibility for such damage.

The technical information specified herein is intended only to show the typical functions of and examples of application circuits for the Products. ROHM does not grant you, explicitly or implicitly, any license to use or exercise intellectual property or other rights held by ROHM and other parties. ROHM shall bear no responsibility whatsoever for any dispute arising from the use of such technical information.

The Products specified in this document are intended to be used with general-use electronic equipment or devices (such as audio visual equipment, office-automation equipment, communication devices, electronic appliances and amusement devices).

The Products specified in this document are not designed to be radiation tolerant.

While ROHM always makes efforts to enhance the quality and reliability of its Products, a Product may fail or malfunction for a variety of reasons.

Please be sure to implement in your equipment using the Products safety measures to guard against the possibility of physical injury, fire or any other damage caused in the event of the failure of any Product, such as derating, redundancy, fire control and fail-safe designs. ROHM shall bear no responsibility whatsoever for your use of any Product outside of the prescribed scope or not in accordance with the instruction manual.

The Products are not designed or manufactured to be used with any equipment, device or system which requires an extremely high level of reliability the failure or malfunction of which may result in a direct threat to human life or create a risk of human injury (such as a medical instrument, transportation equipment, aerospace machinery, nuclear-reactor controller, fuel-controller or other safety device). ROHM shall bear no responsibility in any way for use of any of the Products for the above special purposes. If a Product is intended to be used for any such special purpose, please contact a ROHM sales representative before purchasing.

If you intend to export or ship overseas any Product or technology specified herein that may be controlled under the Foreign Exchange and the Foreign Trade Law, you will be required to obtain a license or permit under the Law.



Thank you for your accessing to ROHM product informations.
More detail product informations and catalogs are available, please contact us.

ROHM Customer Support System

<http://www.rohm.com/contact/>