

APPROVAL SHEET

MODEL NO.: SMD1206R200SF16V

CUSTOMER:

CUSTOMER'S APPROVAL:

AUTHORIZED SIGNATURE/STAMP

DATE

MANUFACTURER:

The Fourth Industrial Zone, Luokeng Village, Xiaotie District, Xiaojinkou Town, Huizhou City, Guangdong Province, China

Tel: 0752-7213069/7213070

Fax: 0752-7213065

Submitted by:

Approved by:

Date:

Performance Specification

Model	Marketing	V _{max} (V dc)	I _{max} (A)	I _{hold} @25°C (A)	I _{trip} @25°C (A)	P _d Typ. (W)	Maximum Time To Trip		Resistance		认证
							Current (A)	Time (Sec)	R _{i min} (Ω)	R _{1max} (Ω)	UL
SMD1206R200SF16V	RY	16.0	35	2.00	3.50	0.8	8.00	1.50	0.015	0.100	

V_{max} = Maximum operating voltage device can withstand without damage at rated current (I_{max}).

I_{max} = Maximum fault current device can withstand without damage at rated voltage (V_{max}).

I_{hold} = Hold Current. Maximum current device will not trip in 25°C still air.

I_{trip} = Trip Current. Minimum current at which the device will always trip in 25°C still air.

P_d = Power dissipation when device is in the tripped state in 25°C still air environment at rated voltage.

R_{i min}/max = Minimum/Maximum device resistance prior to tripping at 25°C.



R_{1max} = Maximum device resistance is measured one hour post reflow.

CAUTION : Operation beyond the specified ratings may result in damage and possible arcing and flame.

Environmental Specifications

Test	Conditions	Resistance change
Passive aging	+85°C, 1000 hrs.	I HOLD/I TRIP PASS
Humidity aging	+85°C, 85% R.H. , 168 hours	I HOLD/I TRIP PASS
Thermal shock	+85°C to -40°C, 20 times	I HOLD/I TRIP PASS
Resistance to solvent	MIL-STD-202,Method 215	No change
Vibration	MIL-STD-202,Method 201	No change
Ambient operating conditions : - 40 °C to +85 °C		
Maximum surface temperature of the device in the tripped state is 125 °C		

Agency Approval and Environmental Compliance

Agency	File Number	Regulation	Standard
UL	pending		2002/95/EC
TUV	pending		EN14582

Thermal Derating Chart

Recommended Hold Current(A) at Ambient Temperature(°C)

Model	Ambient Operation Temperature								
	-40°C	-20°C	0°C	25°C	40°C	50°C	60°C	70°C	85°C
SMD1206R200SF16V	2.88	2.63	2.34	2.00	1.74	1.58	1.42	1.17	0.93

Thermal Derating Curve

Average Time-Current Curve

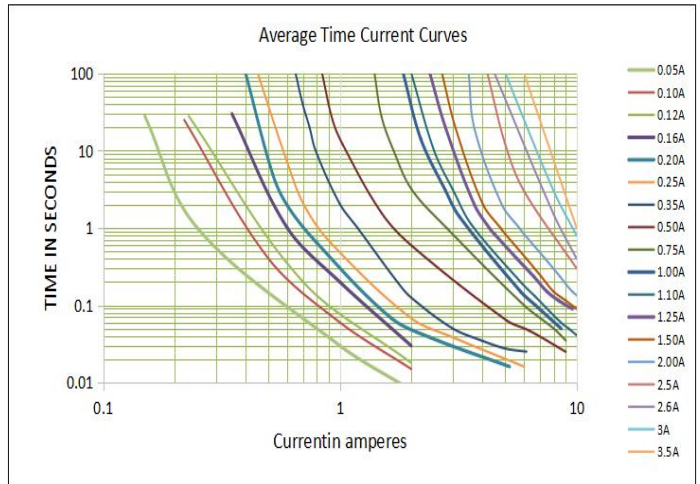
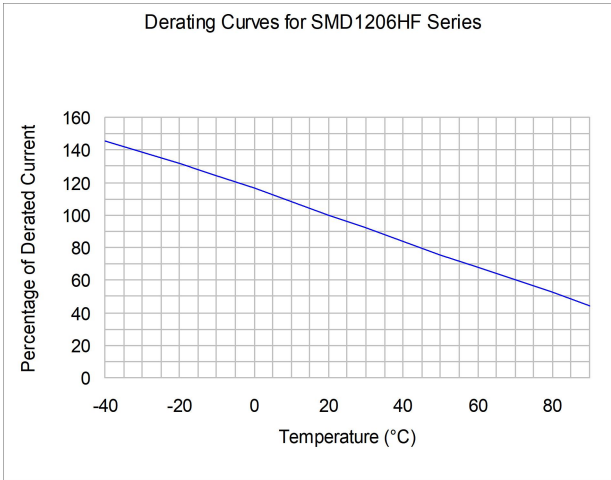

Soldering Parameters

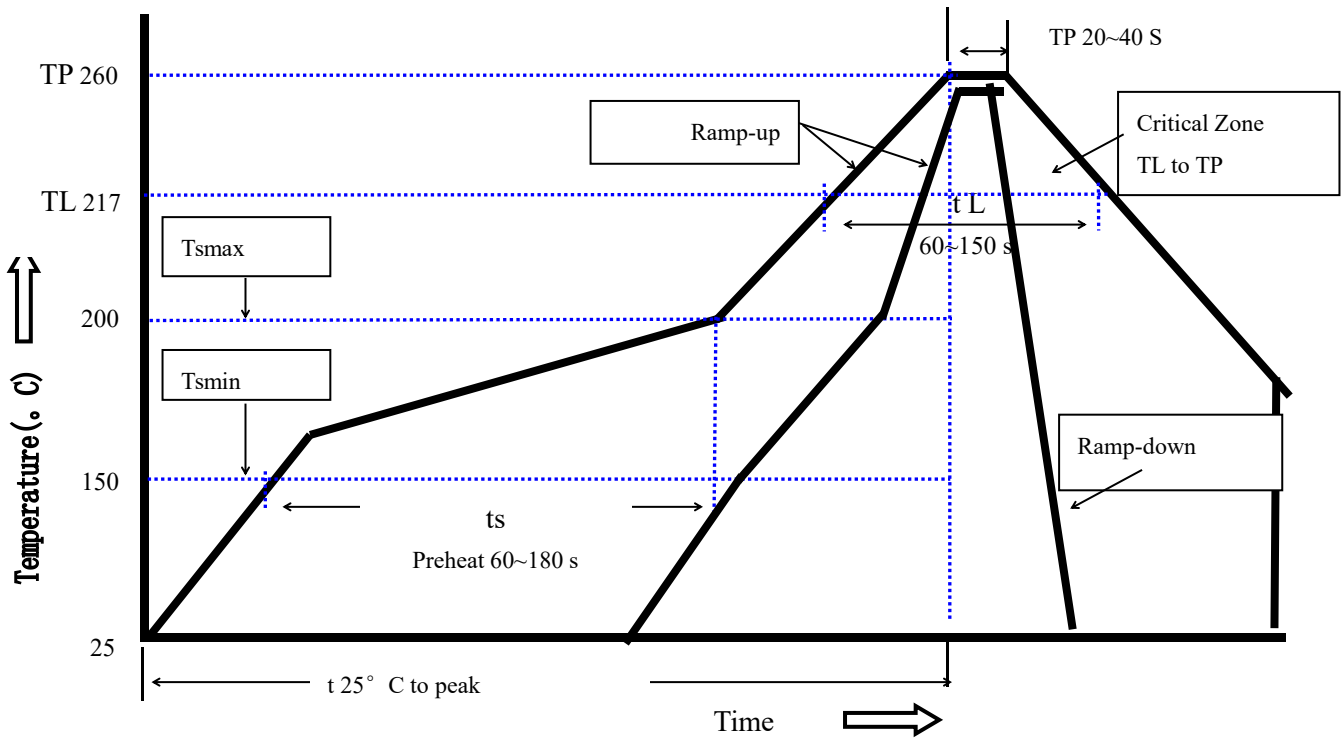

Profile Feature	Pb-Free Assembly
Average Ramp-Up Rate(Ts max to T p)	3°C/second max.
Preheat	
-Temperature Min(Ts min)	150°C
-Temperature Max(Ts max)	200°C
-Time(Ts min to Ts max)	60~180 seconds
Time maintained above:	
-Temperature(TL)	217°C
-Time(tL)	60~150 seconds
Peak Temperature(Tp)	260°C
Ramp-Down Rate	6°C/second max.

HuiZhou DaRong Electronic Technology CO.,LTD

SMD1206R200SF16V Surface Mount PTC Devices

Time 25°C to Peak Temperature	8 minutes max
Storage Condition	遮光密封

Recommended reflow methods: IR, vapor phase oven, hot air oven, N2 environment for lead-free

Recommended maximum paste thickness is 0.25mm

Devices can be cleaned using standard industry methods and solvents.

Note 1: All temperature refer to topside of the package, measured on the package body surface.

Note 2: If reflow temperatures exceed the recommended profile, devices may not meet the performance requirements.

Physical Dimensions(mm.)

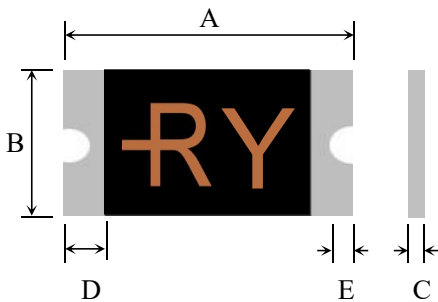

Model	A		B		C		D	E
	Min.	Max.	Min.	Max.	Min.	Max.	Min.	Min.
SMD1206R200SF16V	3.00	3.60	1.50	1.90	1.00	1.60	0.15	0.10

Termination Pad Characteristics

Terminal pad materials: Tin-plated Nickel-Copper

Terminal pad solder ability: Meets EIA specification RS186-9E and ANSI/J-STD-002 Category 3.

Recommended Pad Layout (mm.)

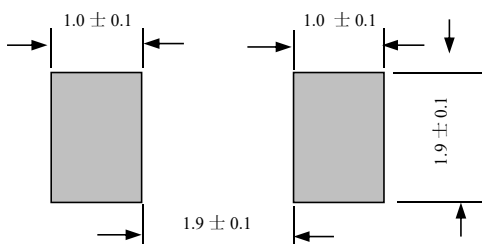

注：在此印锡面积条件下，推荐钢网厚度为 ≥ 0.12 MM(钢网厚度不够要增大刷锡面积)

Packaging Quantity

Part Number	Quantity
SMD1206R200SF16V	3500 pcs/reel

Tape & reel packaging per EIA481-1

Tape And Reel Specifications (mm)

Governing Specifications		EIA 481-1
W	8.15 ± 0.3	
P0	4.0 ± 0.10	
P1	4.0 ± 0.10	
P2	2.0 ± 0.05	
A0	1.95 ± 0.10	
B0	3.40 ± 0.10	
B1max.	4.35	
D0	1.50 + 0.1, -0	
F	3.5 ± 0.05	
E1	1.75 ± 0.10	
E2min.	6.25	
T	0.6	
T1max.	0.1	
K0	1.04 ± 0.1	
Leader min.	390	
Trailer min.	160	
Reel Dimensions		
A max.	178	
N min.	60	
W1	9 ± 0.5	
W2	12.6 ± 0.5	

EIA Tape Component Dimensions

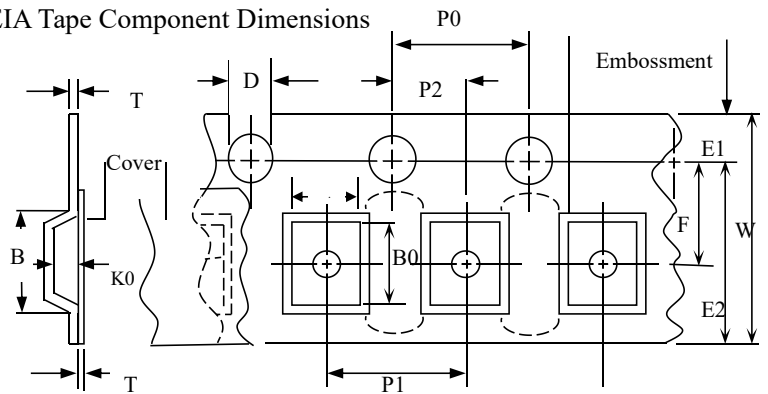

EIA Reel Dimensions

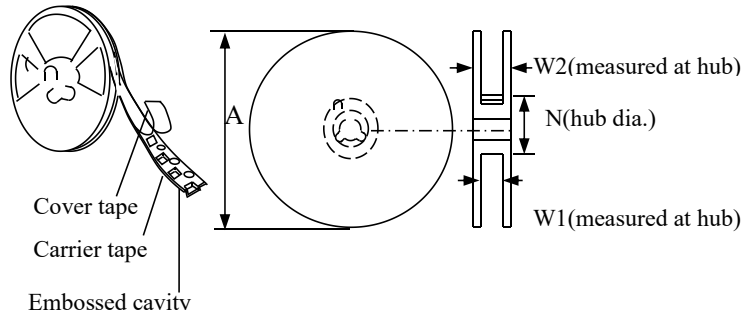

Storage And Handling

- Storage conditions: 遮光密封
- Devices may not meet specified performance if storage conditions are exceeded.

Part Number System

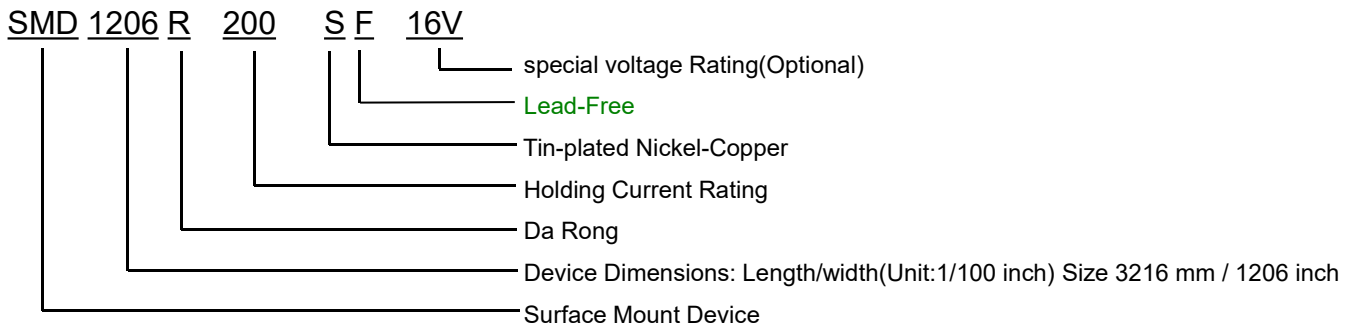

注意事项

PPTC 使用注意事项:

- PPTC 为热敏元件，对环境温度比较敏感，建议在 PPTC 周围不要设计热源元件，环境温度最高控制在 85℃ 以下，尽量减少外部热源的影响，否则会影响产品性能导致焊后电阻大于规格。
- 请在规格书规定的参数下 (<10%) 使用，超出电压电流规格值，会导致 PPTC 出现电弧，阻值升高，甚至烧片。
- 规格书的电气特性，均是基于在大容指定测试板经过一次回流焊之后的测试；如果客户有二次回流焊或者注塑点胶等其他热工序，会对上述参数有一定程度的衰减，需要验证其适用性。
 - PPTC 设备在故障状态下会发生热膨胀。如果 PPTC 装置安装或放置在 PPTC 装置与周围材料（如覆盖材料、包装材料、封装材料等）之间的空间不足的应用中，将对热膨胀产生抑制作用。挤压、扭曲、弯曲和其他类型的机械应力也会对 PPTC 设备的性能产生不利影响，不得使用或施加。
 - PPTC 贴片产品是为 SMT 工艺设计的封装形式，焊接工艺为回流焊；要求客户遵守我们推荐的焊盘布局和回流焊配置文件。不正确的电路板布局或回流配置可能会对 PPTC 的可焊性性能产生负面影响。焊接工艺可参考大容推荐的回流焊曲线。如果回流焊温度超过推荐的值，PPTC 将有可能受到损伤。使用手工焊及波峰焊接 PPTC 可能会导致产品焊后电阻超出规格。
 - 某些注塑料、单组份、双组份固化胶粘剂、硅胶、特种润滑理基脂、侵蚀性溶剂、石蜡污染 PPTC 材料破坏芯片，需要对注塑胶料、石蜡等材料牌号以及应用参数（如温度、时间等）进行验证，以确保产品及工艺的匹配性，确认不会影响 PPTC 性能之后方可使用。PPTC 在充电线端应用中，建议使用 PP 类材料做内膜，禁止使用 TPE 类与 PVC 类等材料做内膜。
 - PPTC 贴装或使用过程中，不建议使用洗板水或其他清洗剂进行清洗。如必须使用，需要验证各类清洗剂、洗板水以及溶剂的适用性，确认不会影响 PPTC 性能之后方可使用。已知对 PPTC 有影响的化学药品包括但不限于醚类、苯类、酮类以及脂类等较强溶解性、破坏性的有机化合物，清洗后将产品放置于敞开的环境中至少 24 小时，将残留的溶剂进行充分的挥发。
 - 装配过程中，避免用暴力砸、挤、压、拉、扭、刺等方式作用 PPTC 本体，以免引起 PPTC 性能衰减。
 - PPTC 元件是为电路中偶尔出现的过流而设计的，不建议用在连续且持续过流、重复故障的电路中（此类故障情况可能是由连接器的错误引脚连接引起的），或过大范围跳闸事件可能发生时，不得使用。
 - 大容 SMD PPTC 产品为遮光密封包装。客户如在库存中发现有包装破损的，立即将产品隔离处理；使用时如有余料，需恢复之前包装状态，做遮光密封保存，否则会影响产品性能导致焊后电阻大于规格。
 - 产品废弃时，可按照一般电子废弃物处理，具体材料组成可参见 MSDS

如果以上注意事项的任何项目未得到遵守，则免除所有的责任。