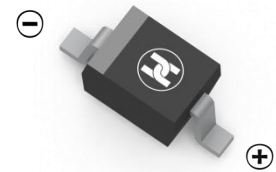
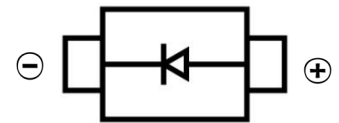

SCHOTTKY BARRIER DIODE
FEATURES

- Low Forward Voltage
- Low Inductance
- Surface Mount device
- For Low Current Rectifier Circuits Applications

SOD-323
MECHANICAL DATA

- Case: SOD-323
- Case Material: Molded Plastic. UL flammability
- Classification Rating: 94V-0
- Weight: 0.005 grams (approximate)

MARKING:5
MAXIMUM RATINGS (T_A = 25°C unless otherwise noted)

Parameter	Symbol	Value	Unit
Peak Reverse Voltage	V _{RM}	40	V
DC Reverse Voltage	V _R	30	V
Mean Rectifying Current	I _o	30	mA
Non-Repetitive Peak Forward Surge Current @ t = 8.3 ms	I _{FSM}	0.2	A
Power Dissipation	P _D	200	mW
Thermal Resistance From Junction To Ambient	R _{θJA}	500	°C/W
Junction Temperature	T _J	125	°C
Storage Temperature	T _{STG}	-55 ~+150	°C

ELECTRICAL CHARACTERISTICS (T_A = 25°C unless otherwise specified)

Parameter	Symbol	Min	Typ	Max	Unit	Conditions
Forward voltage	V _F			0.37	mV	I _F =1mA
Reverse voltage leakage current	I _R			0.5	μA	V _R =30V
Diode capacitance	C _D		2		pF	V _R =1V,f=1MHz

SCHOTTKY BARRIER DIODE

Typical Characteristics

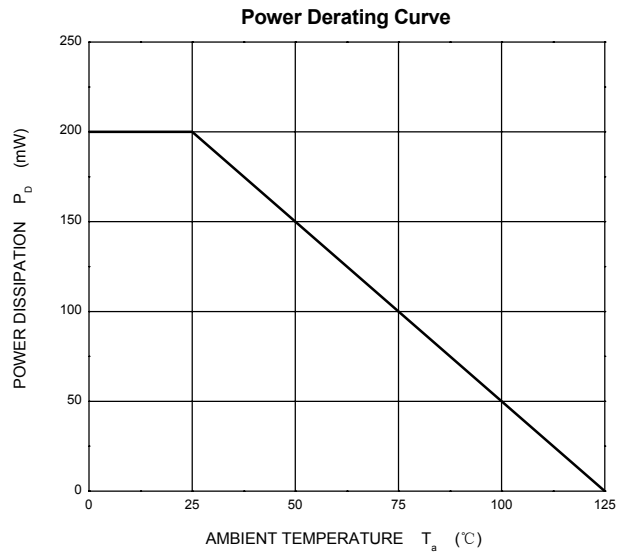
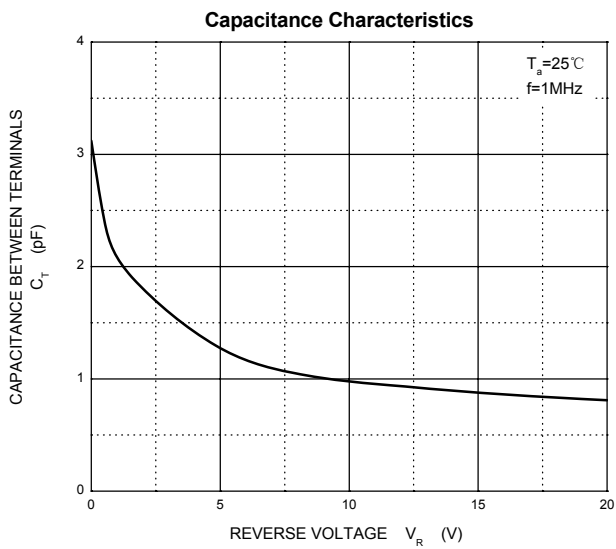
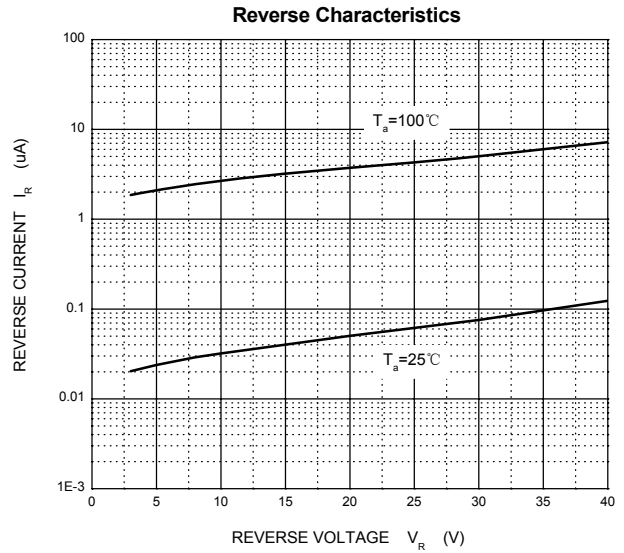
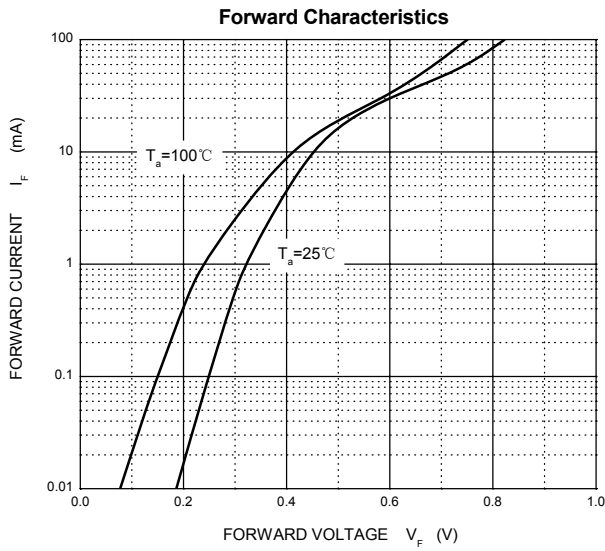

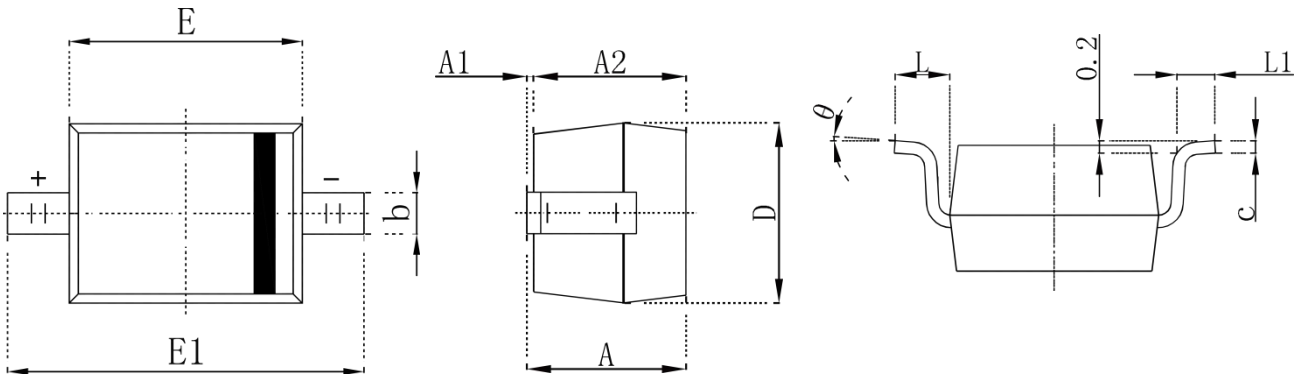
SCHOTTKY BARRIER DIODE
SOD-323 Package Outline Dimensions

Symbol	Dimensions In Millimeters		Dimensions In Inches	
	Min.	Max.	Min.	Max.
A		1.000		0.039
A1	0.000	0.100	0.000	0.004
A2	0.800	0.900	0.031	0.035
b	0.250	0.350	0.010	0.014
c	0.080	0.150	0.003	0.006
D	1.200	1.400	0.047	0.055
E	1.600	1.800	0.063	0.071
E1	2.250	2.750	0.100	0.108
L	0.475 REF		0.019 REF	
L1	0.250	0.400	0.010	0.016
θ	0°	8°	0°	8°

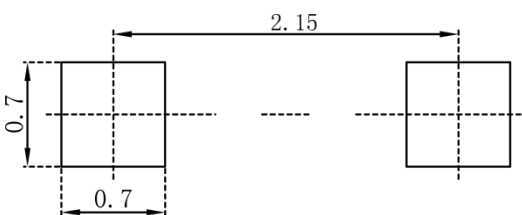
SOD-323 Suggested Pad Layout

Note:

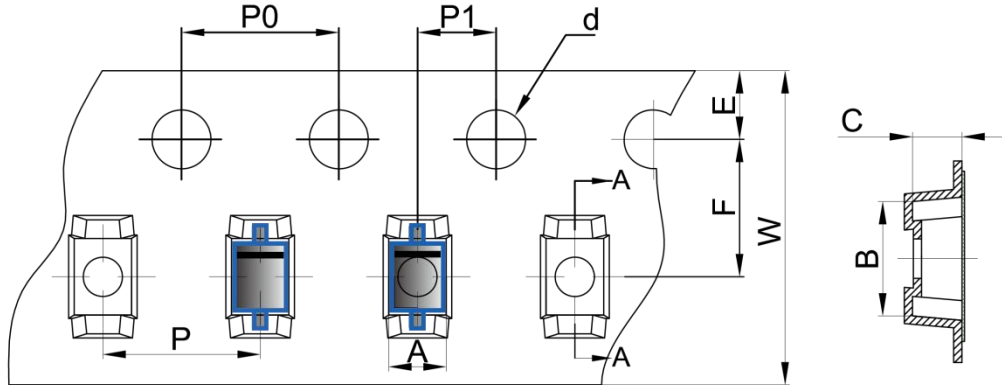
1. Controlling dimension: in millimeters
2. General tolerance: $\pm 0.05\text{mm}$
3. The pad layout is for reference purposes only

SCHOTTKY BARRIER DIODE
SOD-323 Tape and Reel
SOD-323 Embossed Carrier Tape

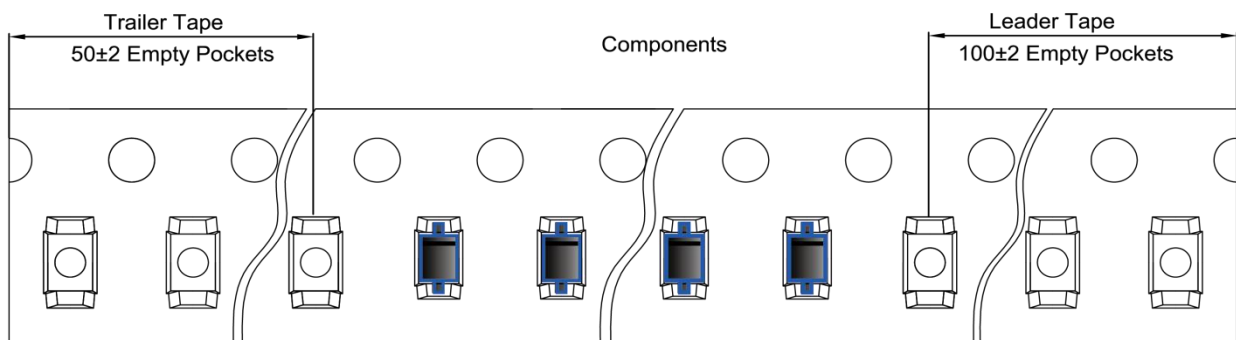
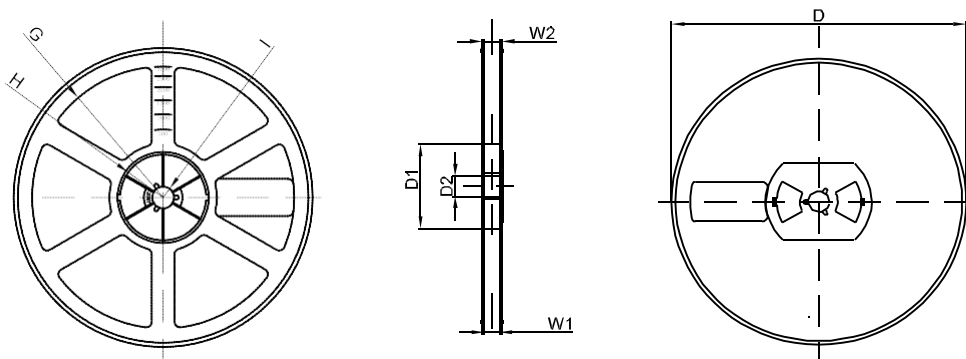
DIMENSIONS ARE IN MILLIMETER										
TYPE	A	B	C	d	E	F	P0	P	P1	W
SOD-323	1.48	3.3	1.25	Ø1.50	1.75	3.50	4.00	4.00	2.00	8.00
TOLERANCE	±0.1	±0.1	±0.1	±0.1	±0.1	±0.1	±0.1	±0.1	±0.1	±0.1

SOD-323 Tape Leader and Trailer

SOD-323 Reel

DIMENSIONS ARE IN MILLIMETER								
REEL OPTION	D	D1	D2	G	H	I	W1	W2
7" DIA	Ø178	54.40	13.00	R78	R25.60	R6.50	9.50	12.30
TOLERANCE	±2	±1	±1	±1	±1	±1	±1	±1