

7	8	9
标记 MARK	ECN编号/变更内容 ECN_NO/DEFINITION	修改 REVISE
		日期 DATE
		核准 APPROVE

PIN	尺寸 (mm)		
	A	B	C
02	1.25	4.25	3.05
03	2.50	5.50	4.30
04	3.75	6.75	5.55
05	5.00	8.00	6.80
06	6.25	9.25	8.05
07	7.50	10.50	9.30
08	8.75	11.75	10.55
09	10.00	13.00	11.80
10	11.25	14.25	13.05
11	12.50	15.50	14.30
12	13.75	16.75	15.55
13	15.00	18.00	16.80
14	16.25	19.25	18.05
15	17.50	20.50	19.30
16	18.75	21.75	20.55

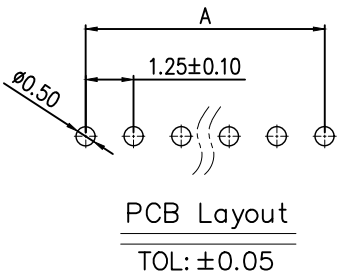
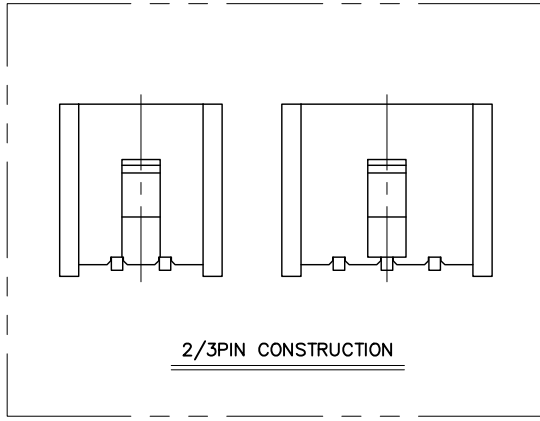
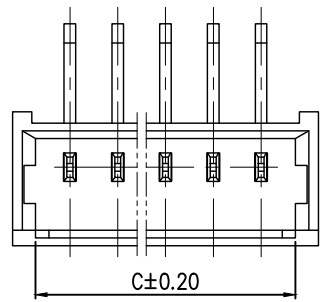
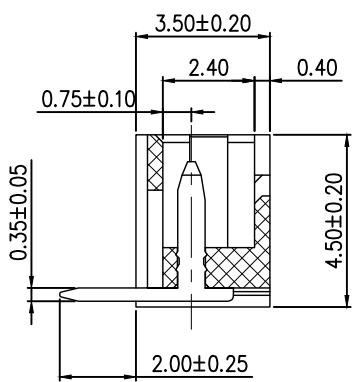
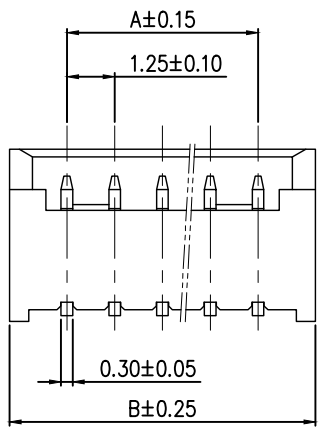

技术要求:

- 额定电流: 1.0A AC, DC  
(注: AWG32# 0.8A)
- 额定电压: 125V AC
- 温度范围: -30° C~85° C
- 接触电阻: ≤0.02 Ω
- 绝缘电阻: ≥500M Ω
- 耐压: 250V/min
- 适用导线规格: AWG26#~32#
- 适用印制板厚度: 0.8mm~1.6mm

2	接触	铜	镀锡	
1	基座	PA66	米色	
序号	品名	材质	电镀/颜色	备注

	深圳市虹成电子有限公司		品名 TITLE	针座
			料号 PART NO	HC-MX1.25-4AW
GENERAL TOLERANCES (UNLESS SPECIFIED)		比列 SCALE	1:1	
X.±0.30	X.±5'	单位 UNIT	MM	制图 DRAW
.X±0.25	.X±3'	张数 PART NO	1 OF 1	审核 CHECKED
.XX±0.20	.XX±1'	版本 REV	A	批准 APPROVE
			夏操云	赵亮亮

