

X3-Class HiPerFET™ Power MOSFET

IXFT150N30X3HV IXFH150N30X3 IXFK150N30X3

$V_{DSS} = 300V$
 $I_{D25} = 150A$
 $R_{DS(on)} \leq 8.3m\Omega$

N-Channel Enhancement Mode
Avalanche Rated

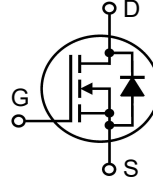

TO-268HV
(IXFT..HV)

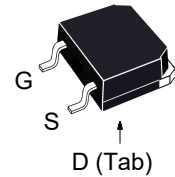

TO-247
(IXFH)

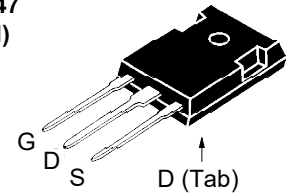

TO-264K
(IXFK)

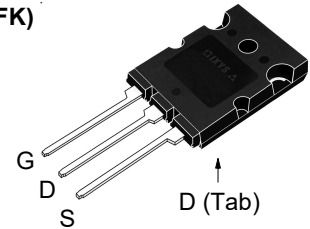

G = Gate D = Drain
S = Source Tab = Drain

Symbol	Test Conditions	Maximum Ratings	
V_{DSS}	$T_J = 25^\circ C$ to $150^\circ C$	300	V
V_{DGR}	$T_J = 25^\circ C$ to $150^\circ C$, $R_{GS} = 1M\Omega$	300	V
V_{GSS}	Continuous	± 20	V
V_{GSM}	Transient	± 30	V
I_{D25}	$T_C = 25^\circ C$	150	A
I_{DM}	$T_C = 25^\circ C$, Pulse Width Limited by T_{JM}	400	A
I_A	$T_C = 25^\circ C$	75	A
E_{AS}	$T_C = 25^\circ C$	2	J
dv/dt	$I_S \leq I_{DM}$, $V_{DD} \leq V_{DSS}$, $T_J \leq 150^\circ C$	20	V/ns
P_D	$T_C = 25^\circ C$	890	W
T_J		-55 ... +150	$^\circ C$
T_{JM}		150	$^\circ C$
T_{stg}		-55 ... +150	$^\circ C$
T_L	Maximum Lead Temperature for Soldering	300	$^\circ C$
T_{SOLD}	1.6 mm (0.062 in.) from Case for 10s	260	$^\circ C$
M_d	Mounting Torque (TO-247 & TO-264K)	1.13 / 10	Nm/lb.in
Weight	TO-268HV	4	g
	TO-247	6	g
	TO-264K	10	g

Symbol	Test Conditions ($T_J = 25^\circ C$, Unless Otherwise Specified)	Characteristic Values		
		Min.	Typ.	Max.
BV_{DSS}	$V_{GS} = 0V$, $I_D = 1mA$	300		V
$V_{GS(th)}$	$V_{DS} = V_{GS}$, $I_D = 4mA$	2.5		4.5 V
I_{GSS}	$V_{GS} = \pm 20V$, $V_{DS} = 0V$			± 100 nA
I_{DSS}	$V_{DS} = V_{DSS}$, $V_{GS} = 0V$ $T_J = 125^\circ C$			25 μA 1 mA
$R_{DS(on)}$	$V_{GS} = 10V$, $I_D = 0.5 \cdot I_{D25}$, Note 1	6.6	8.3	m Ω

Features

- International Standard Packages
- Low $R_{DS(ON)}$ and Q_G
- Avalanche Rated
- Low Package Inductance

Advantages

- High Power Density
- Easy to Mount
- Space Savings

Applications

- Switch-Mode and Resonant-Mode Power Supplies
- DC-DC Converters
- PFC Circuits
- AC and DC Motor Drives
- Robotics and Servo Controls

Symbol	Test Conditions ($T_J = 25^\circ\text{C}$, Unless Otherwise Specified)	Characteristic Values		
		Min.	Typ.	Max
g_{fs}	$V_{DS} = 10\text{V}$, $I_D = 60\text{A}$, Note 1	70	120	S
R_{Gi}	Gate Input Resistance		1.2	Ω
C_{iss}	$V_{GS} = 0\text{V}$, $V_{DS} = 25\text{V}$, $f = 1\text{MHz}$		13.1	nF
C_{oss}			2.0	nF
C_{rss}			1.7	pF
Effective Output Capacitance				
$C_{o(er)}$	Energy related	$V_{GS} = 0\text{V}$ $V_{DS} = 0.8 \cdot V_{DSS}$	700	pF
$C_{o(tr)}$	Time related		2700	pF
$t_{d(on)}$	Resistive Switching Times $V_{GS} = 10\text{V}$, $V_{DS} = 0.5 \cdot V_{DSS}$, $I_D = 0.5 \cdot I_{D25}$ $R_G = 5\Omega$ (External)		40	ns
t_r			32	ns
$t_{d(off)}$			187	ns
t_f			14	ns
$Q_{g(on)}$	$V_{GS} = 10\text{V}$, $V_{DS} = 0.5 \cdot V_{DSS}$, $I_D = 0.5 \cdot I_{D25}$		177	nC
Q_{gs}			63	nC
Q_{gd}			49	nC
R_{thJC}				0.14 $^\circ\text{C/W}$
R_{thCS}	TO-247		0.21	$^\circ\text{C/W}$
	TO-264K		0.15	$^\circ\text{C/W}$

Source-Drain Diode

Symbol	Test Conditions ($T_J = 25^\circ\text{C}$, Unless Otherwise Specified)	Characteristic Values		
		Min.	Typ.	Max
I_S	$V_{GS} = 0\text{V}$			150 A
I_{SM}	Repetitive, pulse Width Limited by T_{JM}			600 A
V_{SD}	$I_F = I_S$, $V_{GS} = 0\text{V}$, Note 1			1.4 V
t_{rr}	$I_F = 75\text{A}$, $-di/dt = 100\text{A}/\mu\text{s}$ $V_R = 100\text{V}$		167	ns
Q_{RM}			1100	nC
I_{RM}			13	A

Note 1. Pulse test, $t \leq 300\mu\text{s}$, duty cycle, $d \leq 2\%$.

Littelfuse reserves the right to change limits, test conditions, and dimensions.

LFMOSFETs and IGBTs are covered by one or more of the following U.S. patents:	4,835,592	4,931,844	5,049,961	5,237,481	6,162,665	6,404,065B1	6,683,344	6,727,585	7,005,734B2	7,157,338B2
	4,860,072	5,017,508	5,063,307	5,381,025	6,259,123B1	6,534,343	6,710,405B2	6,759,692	7,063,975B2	
	4,881,106	5,034,796	5,187,117	5,486,715	6,306,728B1	6,583,505	6,710,463	6,771,478B2	7,071,537	

Fig. 1. Output Characteristics @ $T_J = 25^\circ\text{C}$

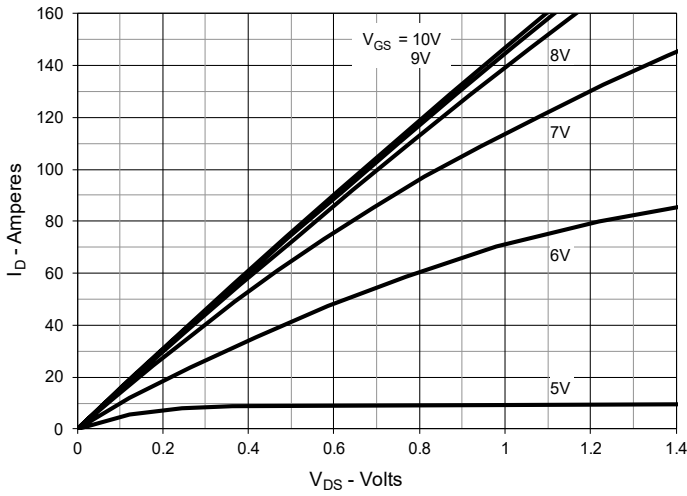

Fig. 2. Extended Output Characteristics @ $T_J = 25^\circ\text{C}$

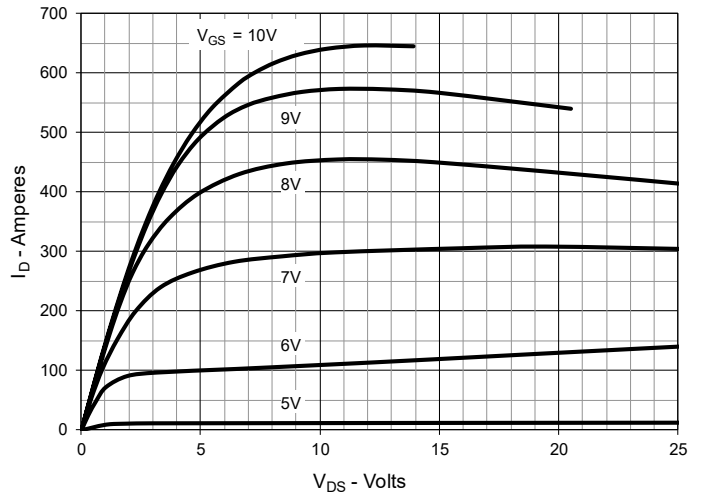

Fig. 3. Output Characteristics @ $T_J = 125^\circ\text{C}$

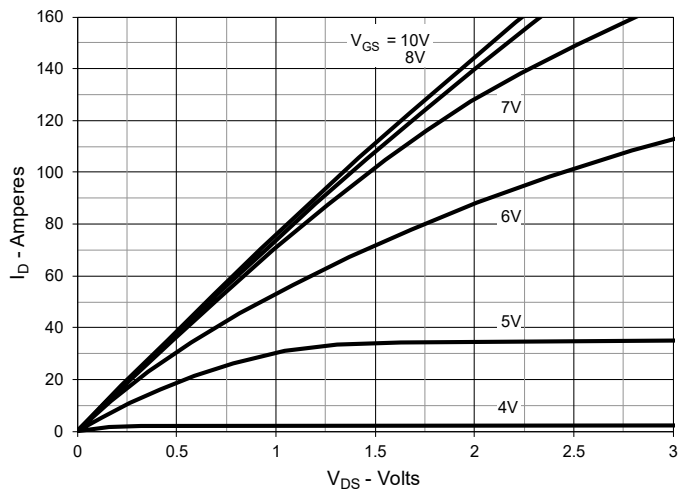

Fig. 4. $R_{DS(on)}$ Normalized to $I_D = 75\text{A}$ Value vs. Junction Temperature

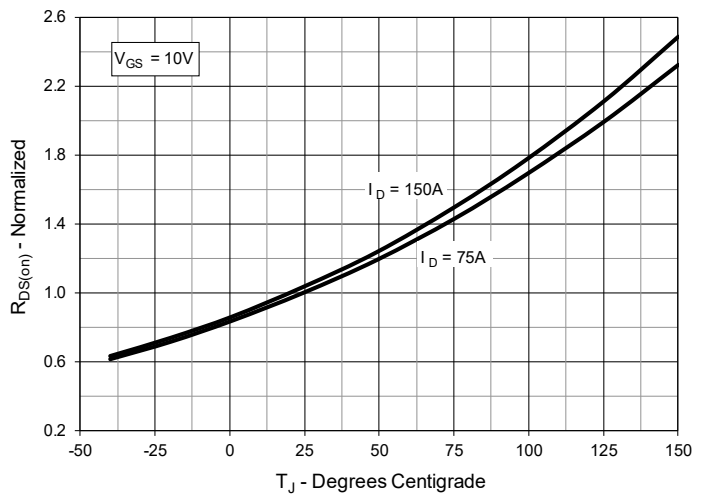

Fig. 5. $R_{DS(on)}$ Normalized to $I_D = 75\text{A}$ Value vs. Drain Current

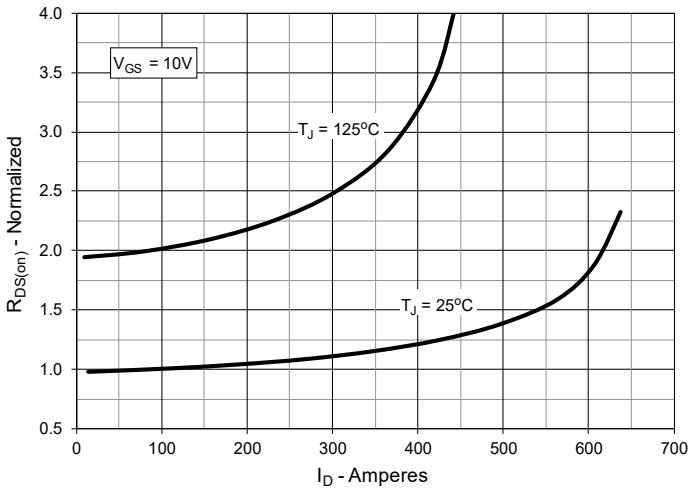

Fig. 6. Normalized Breakdown & Threshold Voltages vs. Junction Temperature

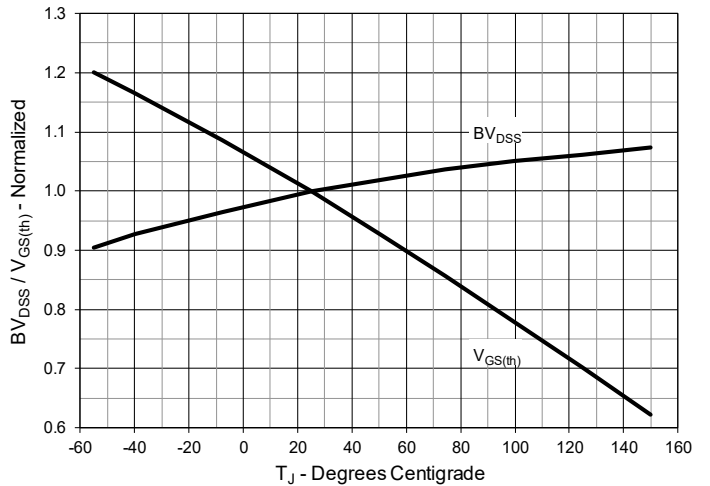

Fig. 7. Maximum Drain Current vs. Case Temperature

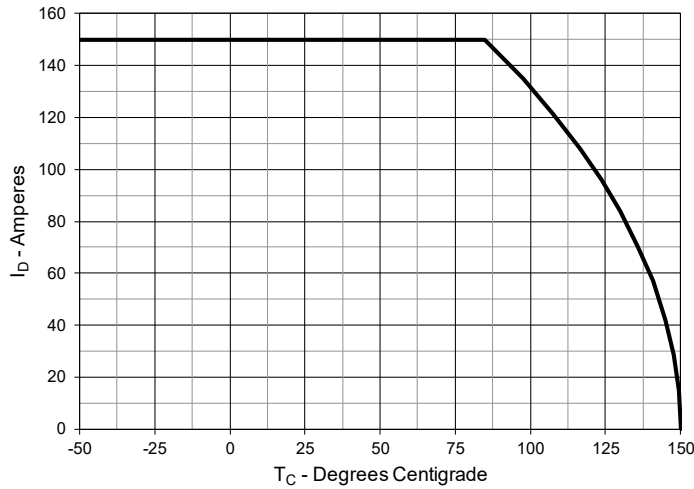

Fig. 8. Input Admittance

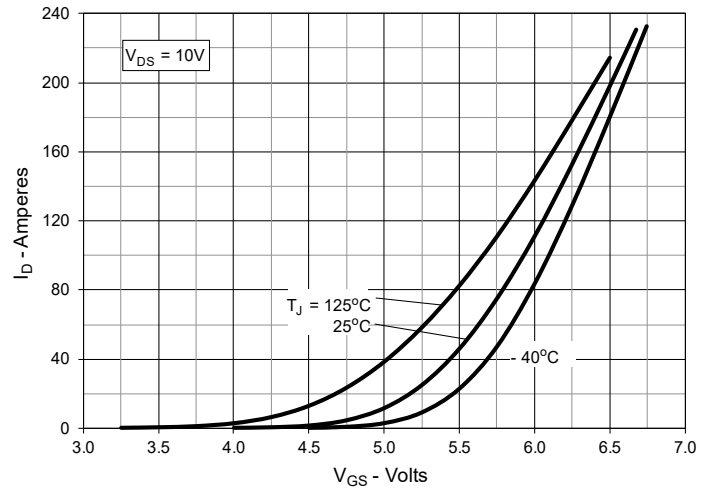

Fig. 9. Transconductance

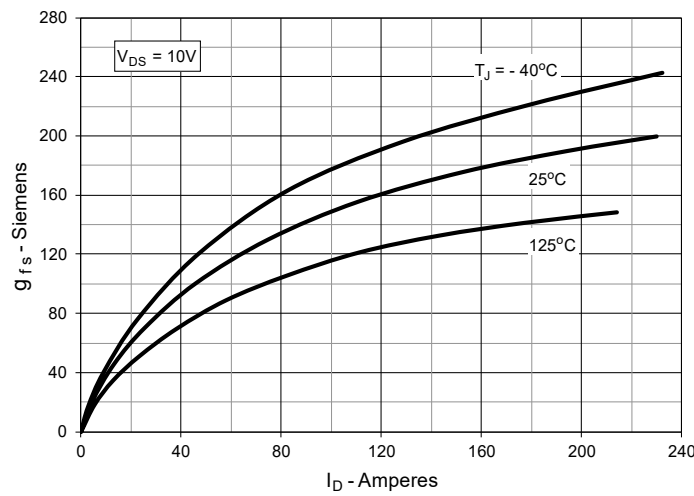

Fig. 10. Forward Voltage Drop of Intrinsic Diode

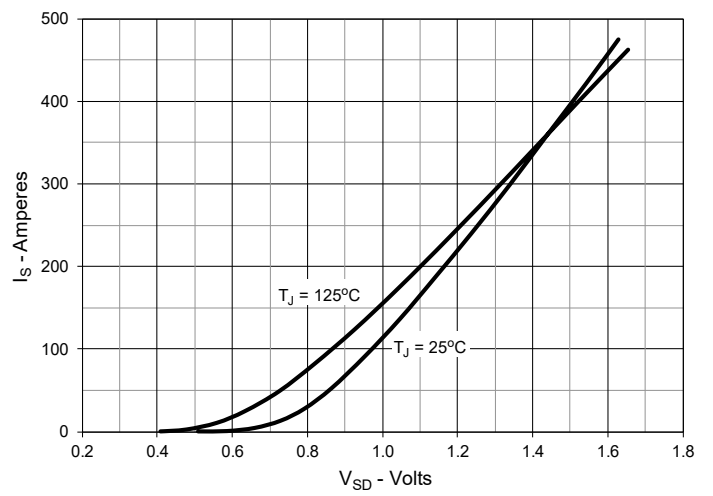

Fig. 11. Gate Charge

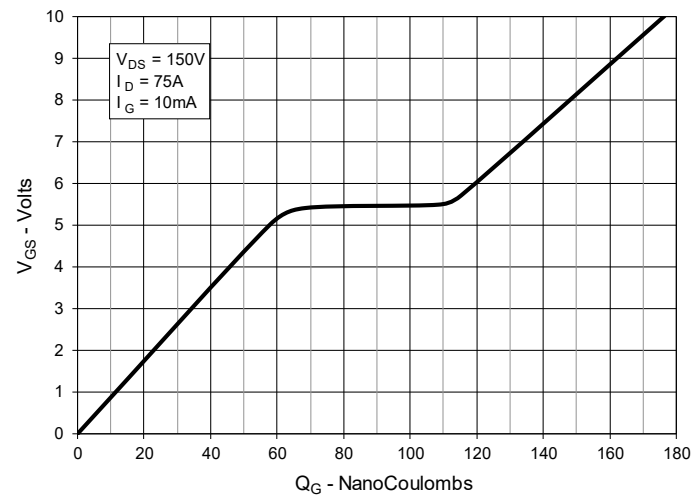

Fig. 12. Capacitance

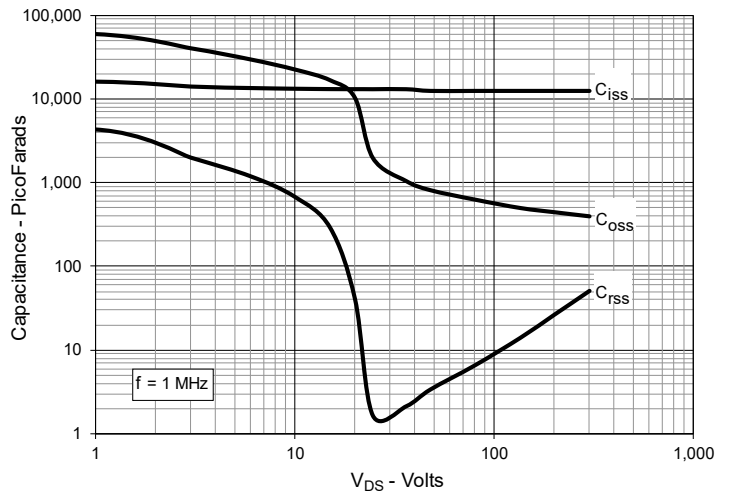

Fig. 13. Output Capacitance Stored Energy

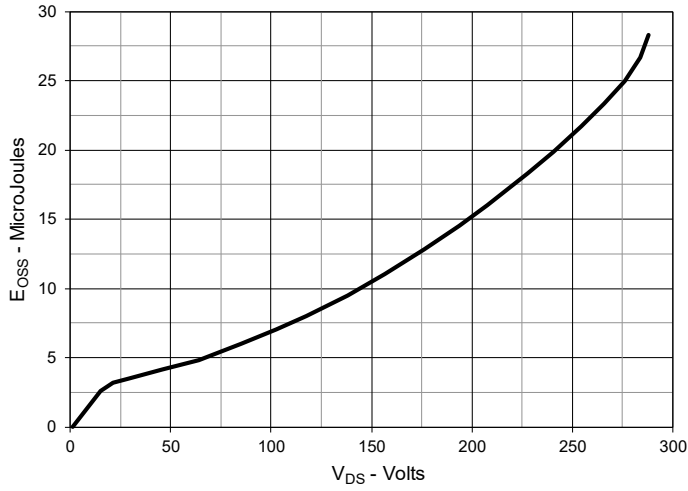

Fig. 14. Forward-Bias Safe Operating Area

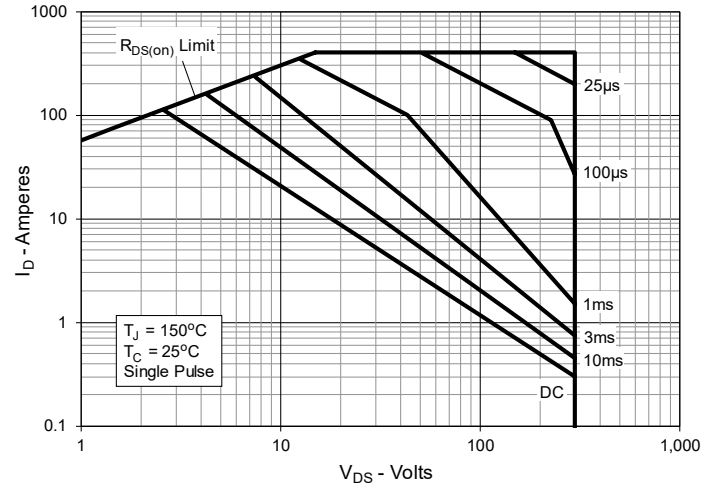
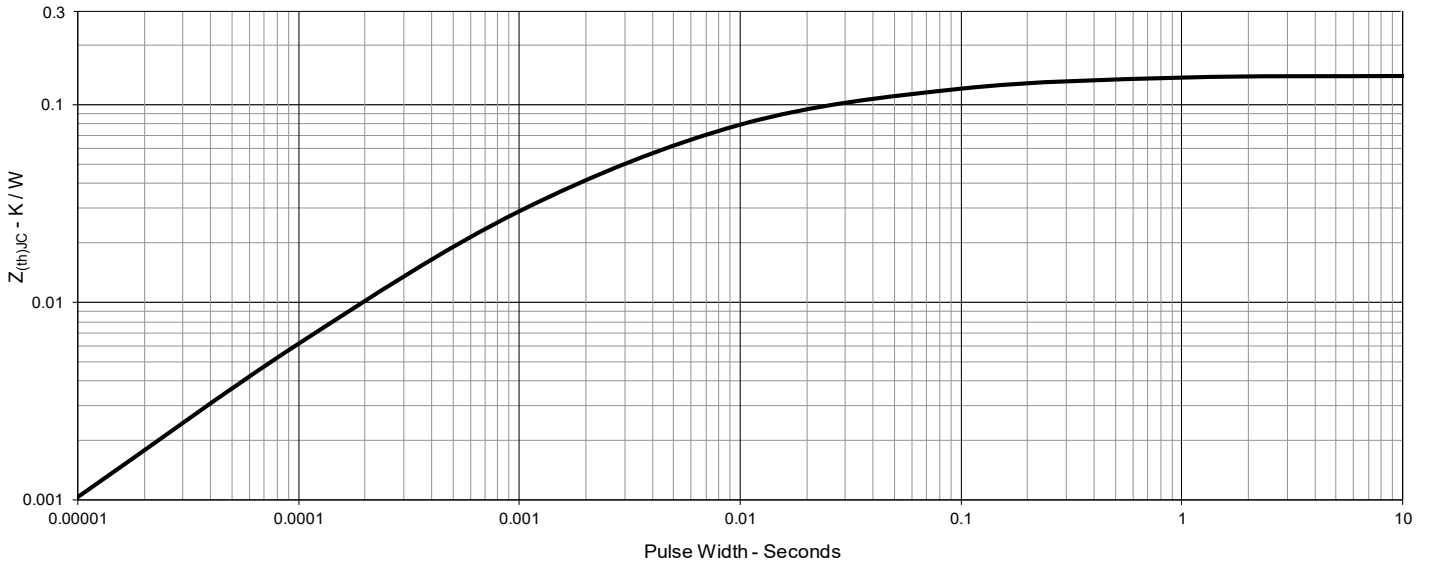
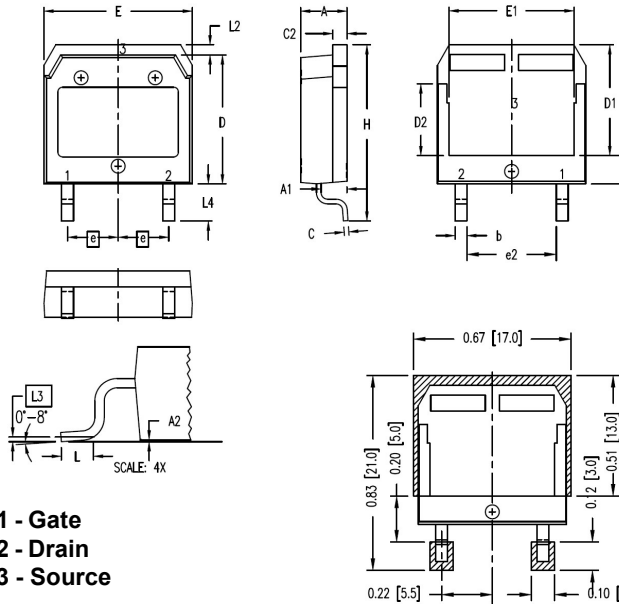

Fig. 15. Maximum Transient Thermal Impedance



TO-268HV Outline



SYM	INCHES		MILLIMETER	
	MIN	MAX	MIN	MAX
A	.193	.201	4.90	5.10
A1	.106	.114	2.70	2.90
A2	.001	.010	0.02	0.25
b	.045	.057	1.15	1.45
C	.016	.026	0.40	0.65
C2	.057	.063	1.45	1.60
D	.543	.551	13.80	14.00
D1	.465	.476	11.80	12.10
D2	.295	.307	7.50	7.80
D3	.114	.126	2.90	3.20
E	.624	.632	15.85	16.05
E1	.524	.535	13.30	13.60
e	.215 BSC		5.45 BSC	
(e2)	.374	.386	9.50	9.80
H	.736	.752	18.70	19.10
L	.067	.079	1.70	2.00
L2	.039	.045	1.00	1.15
L3	.010 BSC		0.25 BSC	
L4	.150	.161	3.80	4.10

TO-247 Outline

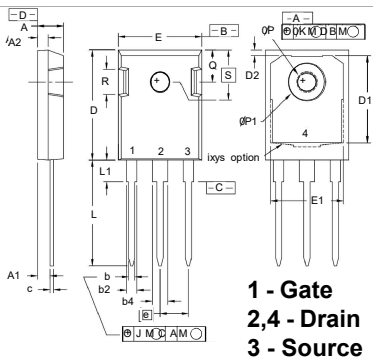

SYM	INCHES		MILLIMETERS	
	MIN	MAX	MIN	MAX
A	.190	.205	4.83	5.21
A1	.090	.100	2.29	2.54
A2	.075	.085	1.91	2.16
b	.045	.055	1.14	1.40
b2	.075	.087	1.91	2.20
b4	.115	.126	2.92	3.20
C	.024	.031	0.61	0.80
D	.819	.840	20.80	21.34
D1	.650	.690	16.51	17.53
D2	.035	.050	0.89	1.27
E	.620	.635	15.75	16.13
E1	.545	.565	13.84	14.35
e	.215 BSC		5.45 BSC	
J	--	.010	--	0.25
K	--	.025	--	0.64
L	.780	.810	19.81	20.57
L1	.150	.170	3.81	4.32
øP	.140	.144	3.55	3.65
øP1	.275	.290	6.99	7.37
Q	.220	.244	5.59	6.20
R	.170	.190	4.32	4.83
S	.242 BSC		6.15 BSC	

TO-264K Outline

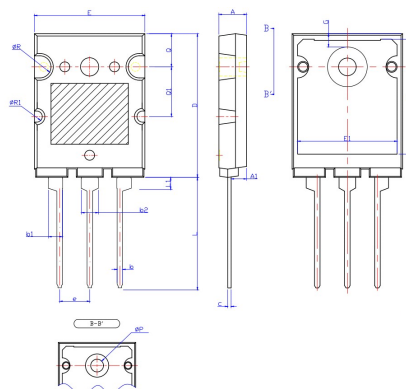

SYM	INCHES		MILLIMETERS	
	MIN	MAX	MIN	MAX
A	0.189	0.205	4.80	5.20
A1	0.098	0.122	2.50	3.10
b	0.035	0.049	0.90	1.25
b1	0.091	0.106	2.30	2.70
b2	0.110	0.126	2.80	3.20
c	0.020	0.033	0.50	0.85
D	1.016	1.031	25.80	26.20
E	0.780	0.795	19.80	20.20
e	0.203	0.226	5.15	5.75
L	0.768	0.807	19.50	20.50
L1	0.094	0.102	2.40	2.60
øP	0.118	0.134	3.00	3.40
Q	0.228	0.244	5.80	6.20
Q1	0.346	0.362	8.80	9.20
E1	0.701	0.717	17.80	18.20
D1	0.811	0.827	20.60	21.00
G	0.087	0.102	2.20	2.60
øR	0.079		2.00	
øR1	0.039		1.00	



Disclaimer Notice - Information furnished is believed to be accurate and reliable. However, users should independently evaluate the suitability of and test each product selected for their own applications. Littelfuse products are not designed for, and may not be used in, all applications. Read complete Disclaimer Notice at www.littelfuse.com/disclaimer-electronics.
