



SSCE24V12N1

1-line Bidirectional Micro Packaged TVS Diodes for ESD Protection

● Description

The SSCE24V12N1 is 24V bi-direction TVS technology to protect voltage sensitive components from ESD. Excellent clamping capability, low leakage, and fast response time provide best in class protection on designs that are exposed to ESD. Because of its small size, it is suited for use in cellular phones, MP3 players, digital cameras and many other portable applications where board space comes at a premium.

The SSCE24V12N1 has been specifically designed to protect sensitive components which are connected to data and transmission lines from overvoltage caused by ESD(electrostatic discharge), and EFT (electrical fast transients).

◇ Feature

- ◇ 300W peak pulse power ($t_P = 8/20\mu s$)
- ◇ DFN1006-2L Package
- ◇ Working voltage: 24V
- ◇ Low capacitance
- ◇ Low leakage current
- ◇ RoHS compliant
- ◇ Complies with following standards:
 - IEC 61000-4-2 (ESD) immunity test
Air discharge: $\pm 30kV$
Contact discharge: $\pm 30kV$
 - IEC61000-4-5 (Surge) 5A (8/20 μs)

● PIN configuration

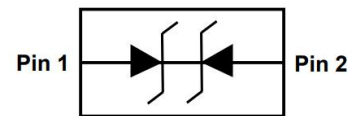

Top view

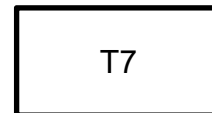

Marking

● Applications

- ◇ Serial and Parallel Ports
- ◇ Notebooks, Desktops, Servers
- ◇ Projection TV
- ◇ Cellular handsets and accessories
- ◇ Portable instrumentation
- ◇ Peripherals
- ◇ MP3 Players

● Mechanical data

- ◇ Lead finish: 100% matte Sn(Tin)
- ◇ Mounting position: Any
- ◇ Qualified max reflow temperature: 260°C
- ◇ Device meets MSL 3 requirements
- ◇ Pure tin plating: 7 ~ 17 μm
- ◇ Pin flatness: $\leq 3mil$



● Electronic Parameter

Symbol	Parameter
V_{RWM}	Peak Reverse Working Voltage
I_R	Reverse Leakage Current @ V_{RWM}
V_{BR}	Breakdown Voltage @ I_T
I_T	Test Current
I_{PP}	Maximum Reverse Peak Pulse Current
V_C	Clamping Voltage @ I_{PP}
P_{PP}	Peak Pulse Power
C_J	Junction Capacitance

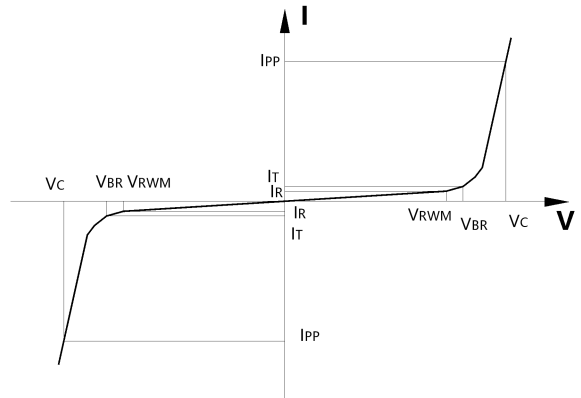

● Absolute maximum rating @ $T_A=25^{\circ}C$

Parameter	Symbol	Value	Unit
Peak Pulse Power (8/20us)	P_{PP}	300	W
Peak Pulse Current (8/20us)	I_{PP}	5	A
ESD Rating per IEC61000-4-2:	Contact	30	kV
	Air	30	
Storage Temperature	T_{STG}	-55/+150	$^{\circ}C$
Operating Temperature	T_J	-55/+125	$^{\circ}C$

● Electrical Characteristics @ $T_A=25^{\circ}C$

Parameter	Symbol	Conditions	Min.	Typ.	Max.	Unit
Peak Reverse Working Voltage	V_{RWM}				24	V
Breakdown Voltage	V_{BR}	$I_T = 1mA$	26.7			V
Reverse Leakage Current	I_R	$V_{RWM} = 24V$			0.2	μA
Clamping Voltage	V_C	$I_{PP} = 1A, t_P = 8/20us$		36	40	V
Clamping Voltage	V_C	$I_{PP} = 5A, t_P = 8/20us$			60	V
Junction Capacitance	C_J	$V_R = 0V, f = 1MHz$		16	20	pF



● Typical Performance Characteristics

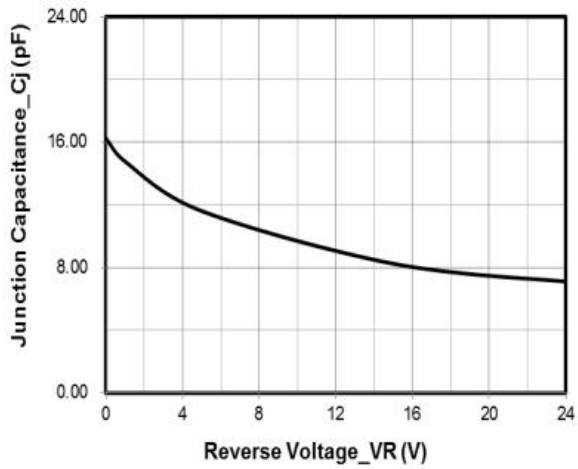

Junction Capacitance vs. Reverse Voltage

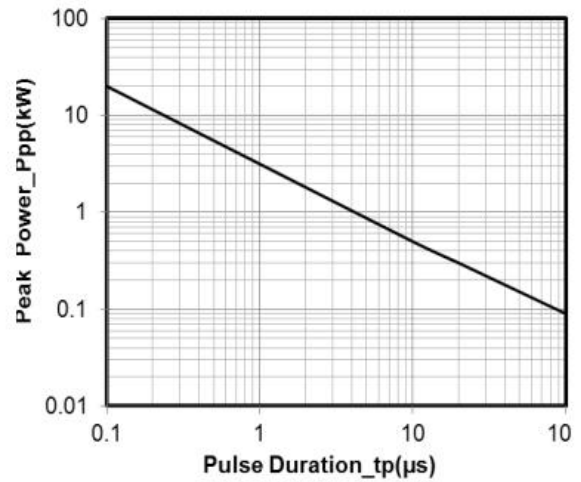

Peak Pulse Power vs. Pulse Time

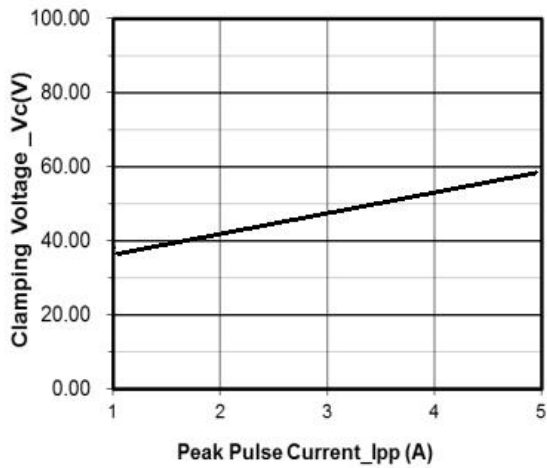

Clamping Voltage vs. Peak Pulse Current

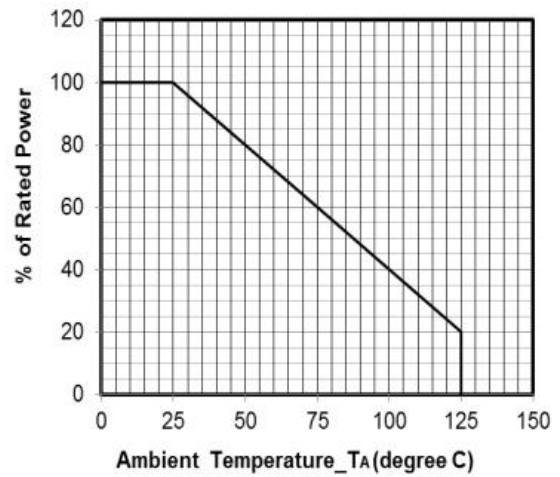

Power Derating Curve

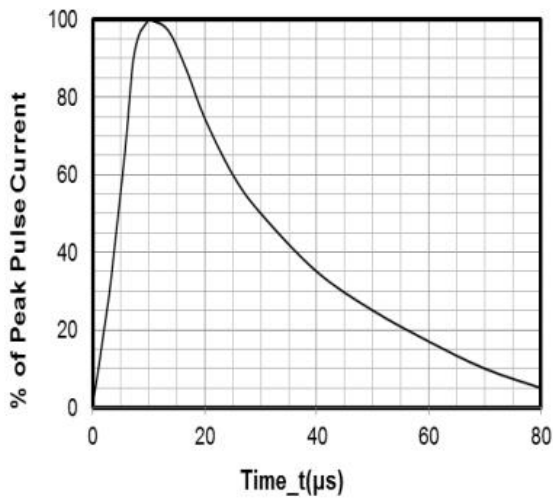

8 X 20μs Pulse Waveform

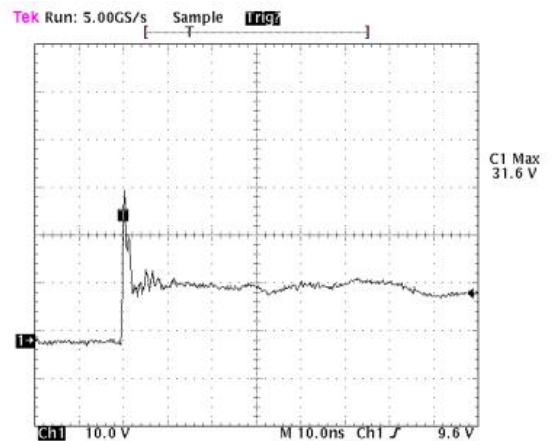

Note: Data is taken with a 10x attenuator
ESD Clamping Voltage
8 kV Contact per IEC61000-4-2



● Package Information

Ordering Information

Device	Package	Qty per Reel	Reel Size
SSCE24V12N1	DFN1006-2L	10000	7 Inch

Mechanical Data

Case:DFN1006-2L

Case Material: Molded Plastic. UL Flammability

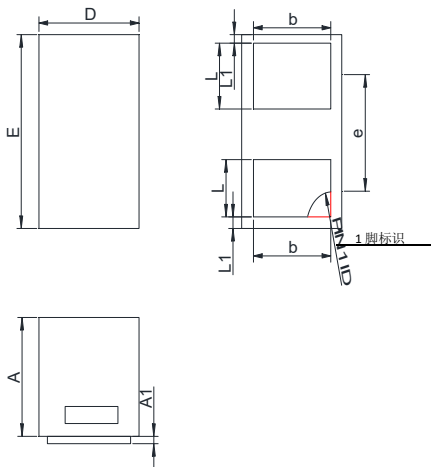

DIM	Millimeters	
	Min	Max
A	0.45	0.55
A1	0.00	0.05
D	0.55	0.65
E	0.95	1.05
b	0.45	0.60
e	0.65TYP	
L	0.2	0.3
L1	0.05REF	

Recommended Pad outline

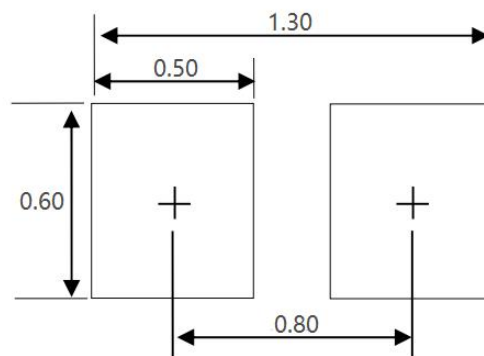

Unit:mm



● Type and Reel Information-DFN1006-2L

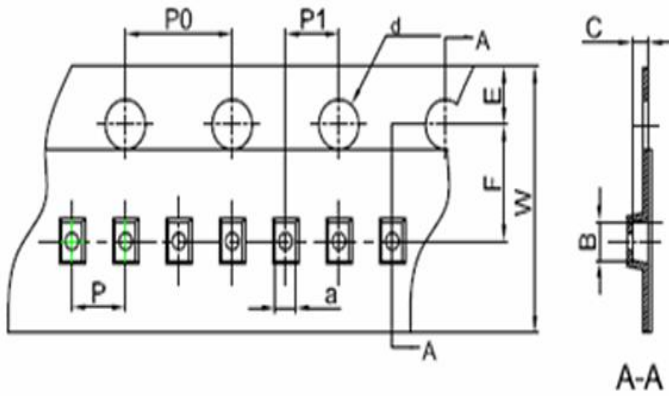

DIM	Millimeters
	Typ
a	0.68
B	1.14
C	0.58
d	Φ 1.55
E	1.75
F	3.50
P0	4.00
P	2.00
P1	2.00
W	8.00

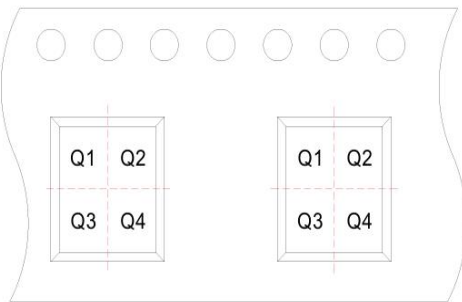

User direction of feed



Pin 1 Quadrant: Q1&Q2

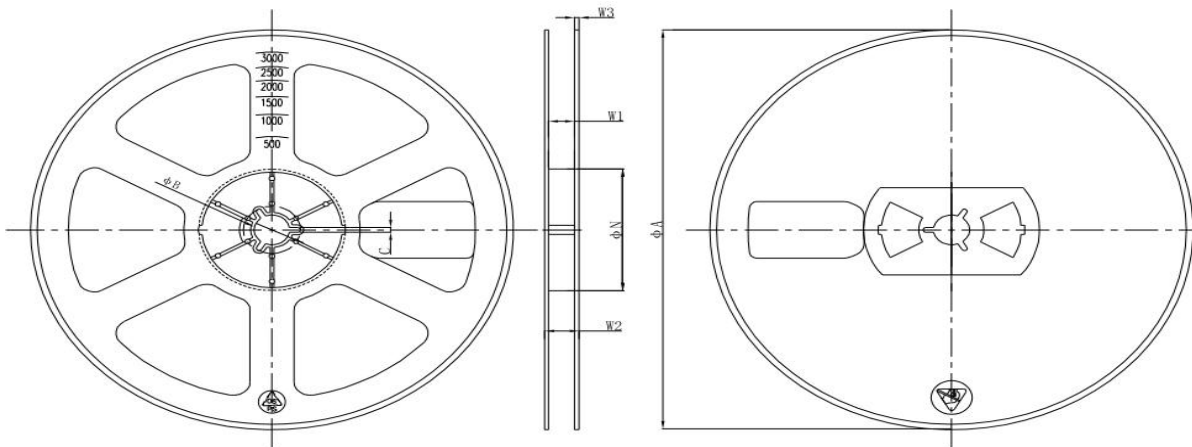

ΦA	ΦN	ΦB	C	W1	W2	W3
178mm	54mm	13.2mm	2.2mm	9.5mm	13 _{max} mm	1.4mm



DISCLAIMER

SSCSEMI RESERVES THE RIGHT TO MAKE CHANGES WITHOUT FURTHER NOTICE TO ANY PRODUCTS HEREIN TO IMPROVE RELIABILITY, FUNCTION OR DESIGN. SSCSEMI DOES NOT ASSUME ANY LIABILITY ARISING OUT OF THE APPLICATION OR USE OF ANY PRODUCT OR CIRCUIT DESCRIBED HEREIN; NEITHER DOES IT CONVEY ANY LICIENCE UNDER ITS PATENT RIGHTS, NOR THE RIGHTS OF OTHERS.

THE GRAPHS PROVIDED IN THIS DOCUMENT ARE STATISTICAL SUMMARIES BASED ON A LIMITED NUMBER OF SAMPLES AND ARE PROVIDED FOR INFORMATIONAL PURPOSE ONLY. THE PERFORMANCE CHARACTERISTICS LISTED IN THEM ARE NOT TESTED OR GUARANTEED. IN SOME GRAPHS, THE DATA PRESENTED MAY BE OUTSIDE THE SPECIFIED OPERATING RANGE (E.G. OUTSIDE SPECIFIED POWER SUPPLY RANGE) AND THEREFORE OUTSIDE THE WARRANTED RANGE.

OUR PRODUCT SPECIFICATIONS ARE ONLY VALID IF OBTAINED THROUGH THE COMPANY'S OFFICIAL WEBSITE, CRM SYSTEM, OR OUR SALES PERSONNEL CHANNELS. IF CHANGES OR SPECIAL VERSIONS ARE INVOLVED, THEY MUST BE STAMPED WITH A QUALITY SEAL AND MARKED WITH A SPECIAL VERSION NUMBER TO BE VALID.