

## FGH20N60SFDTU-VB Datasheet

### 600V Trench and Fieldstop IGBT

PRODUCT SUMMARY		
V <sub>CE</sub> (V)	600	
I <sub>C</sub> (A)	40 (T <sub>C</sub> =25 °C)	20 (T <sub>C</sub> =100 °C)
V <sub>CE (sat)</sub> (V)	1.6	
I <sub>CM</sub> (A)	60	

#### FEATURES

- Very Low V<sub>CEsat</sub>
- Low turn-off losses
- High speed switching
- Maximum junction temperature 175°C
- Ultra low gate charge (Q<sub>g</sub>)
- Avalanche energy rated (UIS)



**RoHS**  
COMPLIANT  
HALOGEN  
**FREE**

#### APPLICATIONS

- Telecommunications
  - Server and telecom power supplies
- Lighting
  - High-intensity discharge (HID)
  - Fluorescent ballast lighting
- Consumer and computing
  - ATX power supplies
- Industrial
  - Welding
  - Battery chargers
- Renewable energy
  - Solar (PV inverters)
- Switch mode power supplies (SMPS)

#### Package pin definition

- Pin1 G - Gate
- Pin2 C & backside - Collector
- Pin3 E - Emitter

TO-247

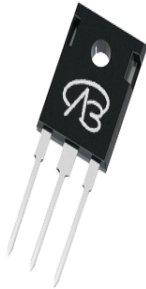

Top View

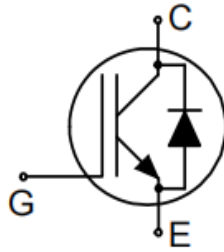

ABSOLUTE MAXIMUM RATINGS (T <sub>C</sub> = 25 °C, unless otherwise noted)			
PARAMETER	SYMBOL	LIMIT	UNIT
Collector-Emitter Voltage	V <sub>CE</sub>	600	V
Gate-Emitter Voltage	V <sub>GE</sub>	±30	
Continuous Collector Current (T <sub>J</sub> = 150 °C)	V <sub>GE</sub> at 15 V	T <sub>C</sub> = 25 °C	A
		T <sub>C</sub> = 100 °C	
Pulsed Collector Current <sup>a</sup>	I <sub>CM</sub>	60	
Diode Forward Current <sup>b</sup>	I <sub>F</sub>	20	A
Maximum Power Dissipation	P <sub>D</sub>	T <sub>C</sub> = 25 °C	266
		T <sub>C</sub> = 100 °C	158
Operating Junction and Storage Temperature Range		T <sub>J</sub> , T <sub>stg</sub>	-55 to +175
Short Circuit Withstand Time <sup>TC=150</sup>	V <sub>GE</sub> = 15V, V <sub>CE</sub> 400V	tsc	3
Short Circuit Withstand Time <sup>TC=100</sup>	V <sub>GE</sub> = 15V, V <sub>CE</sub> 330V		5
Soldering Recommendations (Peak Temperature) <sup>c</sup>	for 10 s		260
			°C

#### Notes

- Repetitive rating; pulse width limited by maximum junction temperature.
- Current limited by maximum junction temperature.
- 1.6 mm from case.

THERMAL RESISTANCE RATINGS				
PARAMETER	SYMBOL	TYP.	MAX.	UNIT
Maximum Junction-to-Ambient	$R_{thJA}$	-	40	°C/W
Maximum Junction-to-Case	$R_{thJC}$	-	0.5	

SPECIFICATIONS ( $T_J = 25\text{ }^\circ\text{C}$ , unless otherwise noted)							
PARAMETER	SYMBOL	TEST CONDITIONS		MIN.	TYP.	MAX.	UNIT
<b>Static</b>							
Collector-Emitter Breakdown Voltage	$BV_{CE}$	$V_{GE} = 0\text{ V}, I_C = 250\text{ }\mu\text{A}$ $V_{GE} = 0\text{ V}, I_C = 1\text{ mA}$		600 600	- -	- -	V
Gate-Source Threshold Voltage (N)	$V_{GE(th)}$	$V_{CE} = V_{GE}, I_D = 250\text{ }\mu\text{A}$		4	5	6	V
Zero Gate Voltage Collector Current	$I_{CES}$	$V_{CE} = 600\text{ V}, V_{GE} = 0\text{ V}, T_J = 25\text{ }^\circ\text{C}$		-	1	20	$\mu\text{A}$
		$V_{CE} = 600\text{ V}, V_{GE} = 0\text{ V}, T_J = 150\text{ }^\circ\text{C}$		-	1000	-	$\mu\text{A}$
Gate-Emitter Leakage Current	$I_{GES}$	$V_{CE} = 0\text{ V}, V_{GS} = \pm 2.0\text{ V}$		-	-	100	nA
Collector-Emitter Saturation Voltage	$V_{CE(sat)}$	$V_{GE} = 15\text{ V}$	$I_C = 20\text{ A}$	-	1.8	2.1	V
Forward Transconductance	$g_{fs}$	$V_{CE} = 20\text{ V}, I_C = 20\text{ A}$		-	17	-	S
<b>Dynamic</b>							
Input Capacitance	$C_{ies}$	$V_{GE} = 0\text{ V}, V_{CE} = 25\text{ V},$ $f = 500\text{ KHz}$		-	2200	-	pF
Output Capacitance	$C_{oes}$			-	162	-	
Reverse Transfer Capacitance	$C_{res}$			-	121	-	
Turn-on Energy	$E_{on}$	$V_{CE} = 400\text{ V}, V_{GE} = 0/15\text{V},$ $I_C = 20\text{ A}, R_g = 10\Omega$		-	17	-	nJ
Turn-off Energy	$E_{off}$			-	0.5	-	
Total Gate Charge	$Q_g$	$V_{GE} = 20\text{ V}$	$I_C = 20\text{ A}, V_{CE} = 400\text{ V}$	-	218	-	nC
Gate-Emitter Charge	$Q_{ge}$			-	62	-	
Gate to Collector Charge	$Q_{gc}$			-	121	-	
Turn-On Delay Time	$t_{d(on)}$	$V_{CE} = 400\text{ V}, V_{GE} = 0/15\text{V},$ $I_C = 20\text{ A}, R_g = 10\Omega$		-	46	-	ns
Rise Time	$t_r$			-	42	-	
Turn-Off Delay Time	$t_{d(off)}$			-	165	-	
Fall Time	$t_f$			-	31	-	
Internal emitter inductance measured 5 mm	$L_E$			-	13	-	
<b>Diode Characteristics</b>							
Diode Forward Current	$I_F$	IGBT symbol showing the integral reverse junction diode		-	-	20	A
Pulsed Diode Forward Current	$I_{FM}$			-	-	60	
Diode Forward Voltage	$V_F$	$I_F = 20\text{ A}$		-	1.51	2.0	V
Reverse Recovery Time	$t_{rr}$	$T_J = 25\text{ }^\circ\text{C}, I_F = 20\text{ A},$ $dI_F/dt = 200\text{ A}/\mu\text{s}, V_R = 400\text{ V}$		-	45	-	ns
Reverse Recovery Charge	$Q_{rr}$			-	0.23	-	$\mu\text{C}$
Reverse Recovery Current	$I_{RRM}$			-	11.6	-	A

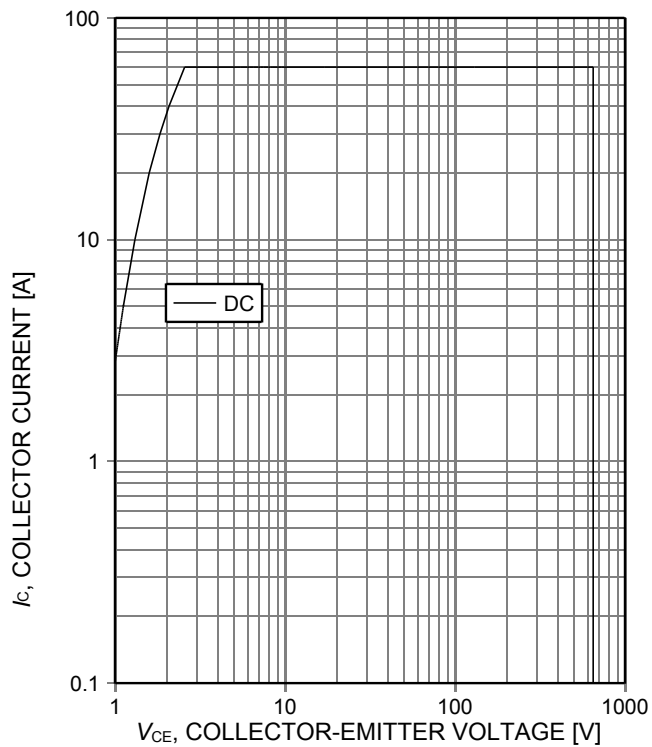

Figure 1. **Forward bias safe operating area**  
( $D=0$ ,  $T_C=25^\circ\text{C}$ ,  $T_{vj}\leq 175^\circ\text{C}$ ;  $V_{GE}=15\text{V}$ .  
Recommended use at  $V_{GE}\geq 7.5\text{V}$ )

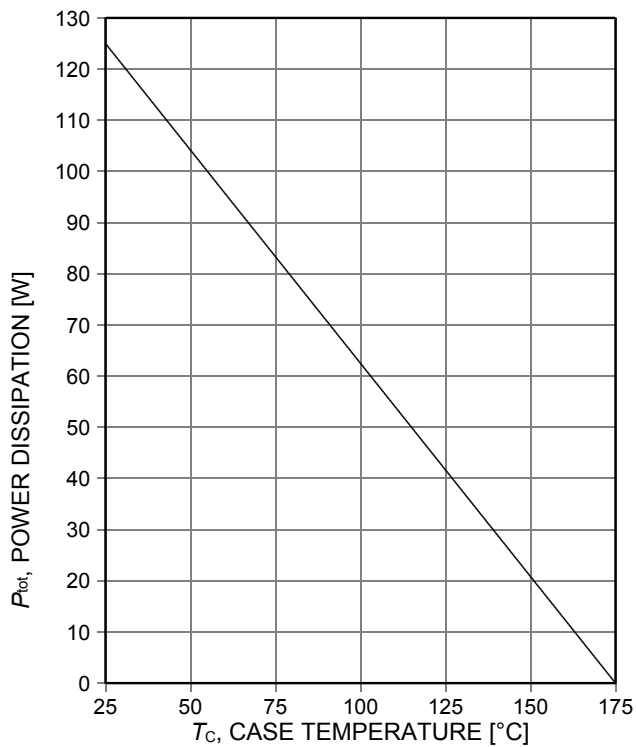

Figure 2. **Power dissipation as a function of case temperature**  
( $T_{vj}\leq 175^\circ\text{C}$ )

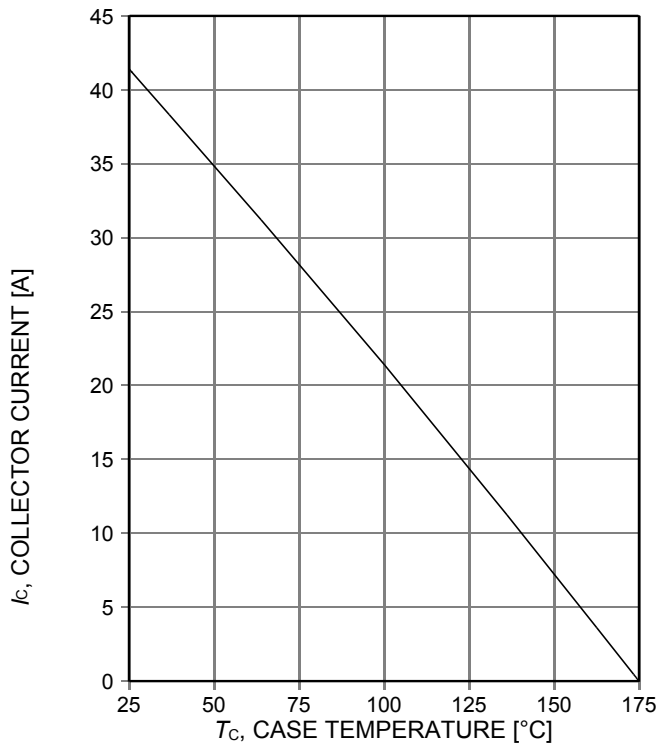

Figure 3. **Collector current as a function of case temperature**

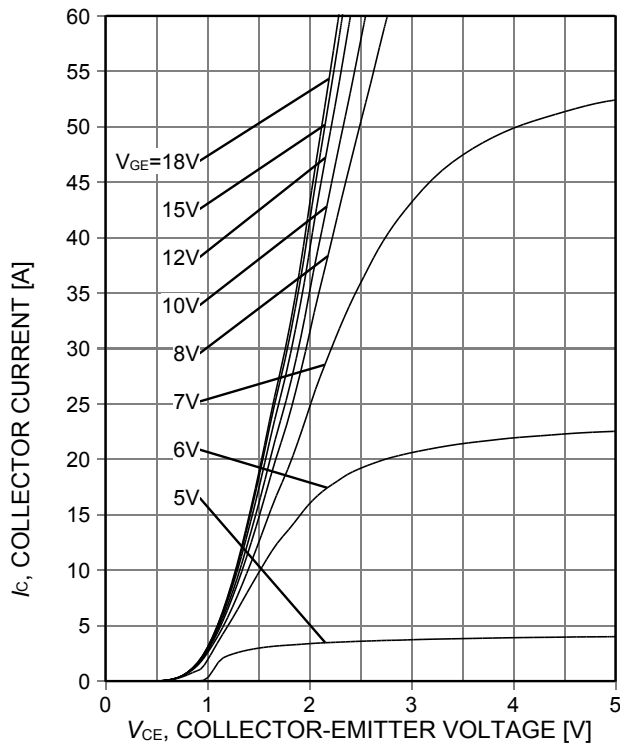

Figure 4. **Typical output characteristic**

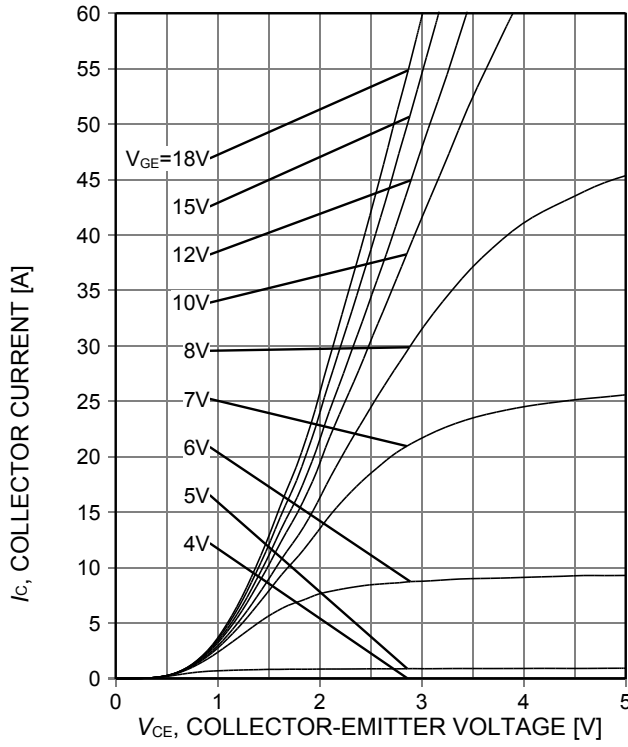

Figure 5. Typical output characteristic ( $T_{vj}=150^{\circ}\text{C}$ )



Figure 6. Typical transfer characteristic ( $V_{CE}=20\text{V}$ )



Figure 7. Typical collector-emitter saturation voltage as a function of junction temperature



Figure 8. Typical switching times as a function of collector current

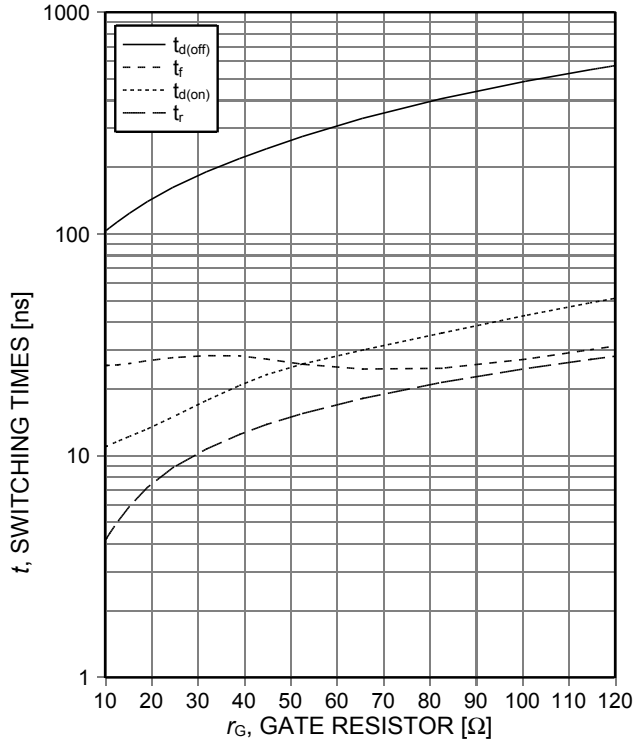

Figure 9. Typical switching times as a function of gate resistor



Figure 10. Typical switching times as a function of junction temperature



Figure 11. Gate-emitter threshold voltage as a function of junction temperature



Figure 12. Typical switching energy losses as a function of collector current



Figure 13. Typical switching energy losses as a function of gate resistor



Figure 14. Typical switching energy losses as a function of junction temperature



Figure 15. Typical switching energy losses as a function of collector emitter voltage



Figure 16. Typical gate charge



Figure 17. Typical capacitance as a function of collector-emitter voltage



Figure 18. IGBT transient thermal impedance

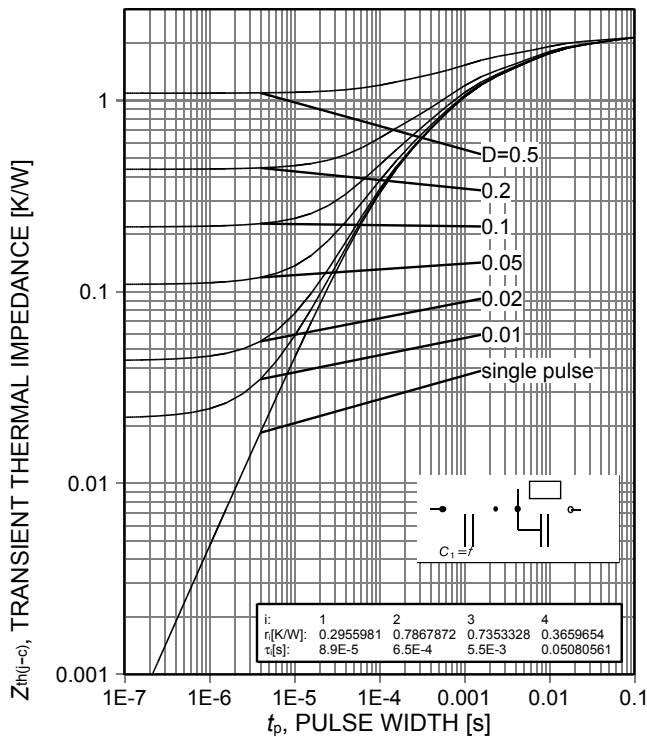
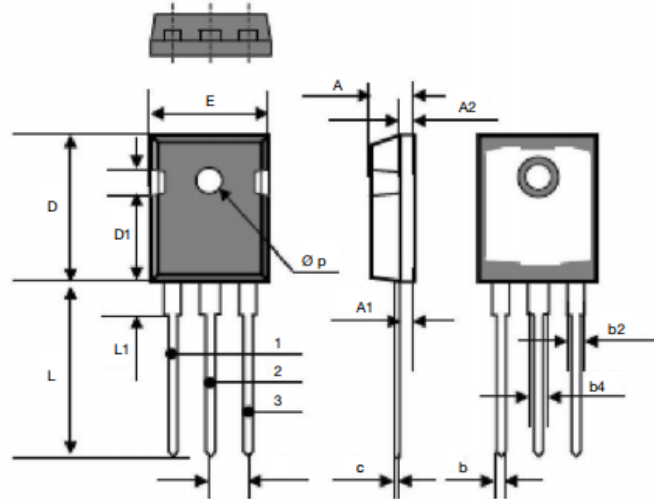

Figure 19. Diode transient thermal impedance as a function of pulse width



Figure 20. Typical reverse recovery time as a function of diode current slope

TO-247



DIM.	MILLIMETERS		INCHES	
	MIN.	MAX.	MIN.	MAX.
A	4.70	5.31	0.185	0.209
A1	2.21	2.59	0.087	0.102
A2	1.50	2.49	0.059	0.098
b	0.99	1.40	0.039	0.055
b2	1.65	2.41	0.065	0.095
b4	2.59	3.43	0.102	0.135
c	0.61 BSC		0.024 BSC	
D	20.80	21.46	0.819	0.845
D1	3.68	5.49	0.145	0.216
(e)	5.46 BSC		0.215 BSC	
E	15.49	16.26	0.610	0.640
L	19.81	20.32	0.780	0.800
L1	4.06	4.50	0.160	0.177
$\varnothing p$	3.51	3.66	0.138	0.144

# Disclaimer

All products due to improve reliability, function or design or for other reasons, product specifications and data are subject to change without notice.

Taiwan VBsemi Electronics Co., Ltd., branches, agents, employees, and all persons acting on its or their representatives (collectively, the "Taiwan VBsemi"), assumes no responsibility for any errors, inaccuracies or incomplete data contained in the table or any other any disclosure of any information related to the product.(www.VBsemi.com)

Taiwan VBsemi makes no guarantee, representation or warranty on the product for any particular purpose of any goods or continuous production. To the maximum extent permitted by applicable law on Taiwan VBsemi relinquished: (1) any application and all liability arising out of or use of any products; (2) any and all liability, including but not limited to special, consequential damages or incidental ; (3) any and all implied warranties, including a particular purpose, non-infringement and merchantability guarantee.

Statement on certain types of applications are based on knowledge of the product is often used in a typical application of the general product VBsemi Taiwan demand that the Taiwan VBsemi of. Statement on whether the product is suitable for a particular application is non-binding. It is the customer's responsibility to verify specific product features in the products described in the specification is appropriate for use in a particular application. Parameter data sheets and technical specifications can be provided may vary depending on the application and performance over time. All operating parameters, including typical parameters must be made by customer's technical experts validated for each customer application. Product specifications do not expand or modify Taiwan VBsemi purchasing terms and conditions, including but not limited to warranty herein.

Unless expressly stated in writing, Taiwan VBsemi products are not intended for use in medical, life saving, or life sustaining applications or any other application. Wherein VBsemi product failure could lead to personal injury or death, use or sale of products used in Taiwan VBsemi such applications using client did not express their own risk. Contact your authorized Taiwan VBsemi people who are related to product design applications and other terms and conditions in writing.

The information provided in this document and the company's products without a license, express or implied, by estoppel or otherwise, to any intellectual property rights granted to the VBsemi act or document. Product names and trademarks referred to herein are trademarks of their respective representatives will be all.

## Material Category Policy

**Taiwan VBsemi Electronics Co., Ltd., hereby certify that all of the products are determined to be RoHS compliant and meets the definition of restrictions under Directive of the European Parliament 2011/65 / EU, 2011 Nian. 6. 8 Ri Yue restrict the use of certain hazardous substances in electrical and electronic equipment (EEE) - modification, unless otherwise specified as inconsistent.(www.VBsemi.com)**

**Please note that some documents may still refer to Taiwan VBsemi RoHS Directive 2002/95 / EC. We confirm that all products identified as consistent with the Directive 2002/95 / EC European Directive 2011/65 /.**

**Taiwan VBsemi Electronics Co., Ltd. hereby certify that all of its products comply identified as halogen-free halogen-free standards required by the JEDEC JS709A. Please note that some Taiwanese VBsemi documents still refer to the definition of IEC 61249-2-21, and we are sure that all products conform to confirm compliance with IEC 61249-2-21 standard level JS709A.**