



Features

- Wide bandgap SiC MOSFET technology
- Low On-Resistance with High Blocking Voltage
- Low Capacitances with High-Speed switching
- Low reverse recovery(Qrr)
- Halogen free, RoHs compliant

Benefits

- Reduce switching losses
- Increased system Switching Frequency
- Increased power density
- Reduction of heat sink requirements

Applications

- Switch mode power supplies
- Renewable energy
- On Board Charger
- High Voltage DC/DC Converters

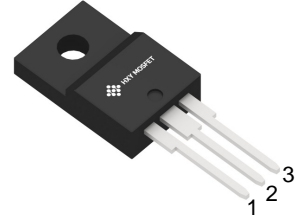

TO-220F

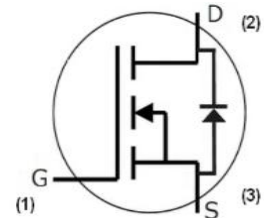

Ordering Part Number	Package	Brand
STF40N65M2	TO-220F	HXY MOSFET

Maximum Ratings (T_c = 25 °C unless otherwise specified)

Symbol	Parameter	Test conditions	Value	Unit	Note
V _{DSmax}	Drain-Source Voltage	V _{GS} = 0V, I _D = 100μA	650	V	
V _{GS}	Gate-Source voltage (transient)	t _p ≤ 500ns, duty cycle ≤ 1%	-8/+20	V	
V _{GSop}	Recommend Gate-Source Voltage	Static	-4/+18	V	
EAS	Single pulse avalanche energy	V _{DS} =650V, V _{DD} =50V, V _{GS} =10V, L=10mH, T _C =25°C	332	mJ	
I _D	Continuous Drain current	V _{GS} = 18V, T _C = 25°C	24	A	Fig. 14
		V _{GS} = 18V, T _C = 100°C	17		
I _{D,pulse}	Pulsed Drain Current	Pulse with t _p limited by T _{jmax}	53	A	
P _D	Power Dissipation	T _C = 25°C, T _J = 175°C	64	W	Fig. 16
T _j	Operating junction temperature		-55~175	°C	
T _{stg}	Storage temperature		-55~175	°C	



Thermal Characteristics

Symbol	Parameter	Value			Unit	Note
		Min.	Typ.	Max.		
$R_{th(jc)}$	Thermal resistance from Junction to Case		2.35		K/W	Fig. 15
$R_{th(ja)}$	Thermal resistance from Junction to Ambient		40		K/W	

Electrical Characteristics (T_c = 25°C unless other wise specified)

Static Characteristics

Symbol	Parameter	Test conditions	Value			Unit	Note
			Min.	Typ.	Max.		
$V_{(BR)DSS}$	Drain-Source Breakdown voltage	$V_{GS} = 0V, I_D = 100\mu A$	650			V	
$V_{GS(th)}$	Gate Threshold voltage	$V_{GS} = V_{DS}, I_D = 4mA$		3.0		V	Fig. 9
		$V_{GS} = V_{DS}, I_D = 4mA, T_j = 175^\circ C$		2.0			
I_{GSS}	Gate-Source Leakage current	$V_{GS} = 18V, V_{DS} = 0V$			250	nA	
I_{DSS}	Zero Gate Voltage Drain Current	$V_{DS} = 650V, V_{GS} = 0V, T_j = 25^\circ C$		1	50	μA	
$R_{DS(on)}$	Drain-Source On-state Resistance	$V_{GS} = 18V, I_D = 10A$		95	125	m Ω	Fig. 3, 4, 5
		$V_{GS} = 18V, I_D = 10A, T_j = 175^\circ C$		135			
g_{fs}	Transconductance	$V_{DS} = 18V, I_D = 10A$		7		S	Fig. 6
		$V_{DS} = 18V, I_D = 10A, T_j = 175^\circ C$		6			



Gate Charge Characteristics

Symbol	Parameter	Test conditions	Value			Unit	Note
			Min.	Typ.	Max.		
Q_{GS}	Gate to Source Charge	$V_{DS} = 400V$ $I_D = 10A$ $V_{GS} = -4V/18V$		7.8		nC	Fig. 10
Q_{GD}	Gate to Drain Charge			9			
Q_G	Total Gate Charge			34			

AC Characteristics

Symbol	Parameter	Test conditions	Value			Unit	Note
			Min.	Typ.	Max.		
C_{iss}	Input Capacitance	$V_{GS} = 0V, V_{DS} = 600V$ $f = 1\text{ MHz}$ $V_{AC} = 25mV$		803		pF	Fig. 13
C_{oss}	Output Capacitance			77		pF	
C_{rss}	Reverse Transfer Capacitance			5		pF	
$R_{G(int)}$	Internal Gate Resistance	$f=1\text{ MHz}, V_{AC} = 25mV$		3.8		Ω	



Reverse Diode Characteristics

Symbol	Parameter	Test conditions	Value			Unit	Note
			Min.	Typ.	Max.		
V_{SD}	Diode Forward Voltage	$V_{GS} = -4V, I_{SD} = 5A$		1.4	4.0	V	Fig. 7,8
		$V_{GS} = -4V, I_{SD} = 5A, T_j = 175^\circ C$		1.9	4.5		
I_S	Continuous Diode Forward Current	$V_{GS} = -5V, T_C = 25^\circ C$		19		A	
$I_{S, pulse}$	Diode pulse Current	$V_{GS} = -5V$, pulse width t_p limited by T_{jmax}		53		A	
t_{rr}	Reverse Recovery Time	$V_{GS} = -4V, I_{SD} = 10A, V_R = 400V$ $diff/dt = 1000A/us$		29		nS	
Q_{rr}	Reverse Recovery Charge			63		nC	
I_{rm}	Peak Reverse Recovery Current			5		A	

Switching Characteristics

Symbol	Parameter	Test conditions	Value			Unit	Note
			Min.	Typ.	Max.		
$t_{d(on)}$	Turn-On Delay Time	$V_{DS} = 400V, V_{GS} = -4/+18V$ $I_D = 10A, R_{G(ext)} = 5\Omega$ $L = 294\mu H$		5		nS	Fig.21
t_r	Rise Time			18		nS	
$t_{d(off)}$	Turn-Off Delay Time			17		nS	
t_f	Fall Time			10		nS	
E_{on}	Turn-On Energy			43		μJ	Fig.19
E_{off}	Turn-Off Energy			17		μJ	
E_{tot}	Total switching energy			60		μJ	



Typical Performance

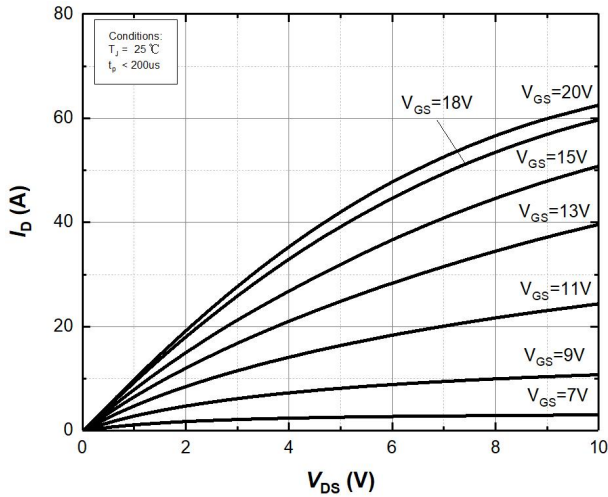

Figure 1. Output characteristics at $T_j=25^\circ\text{C}$

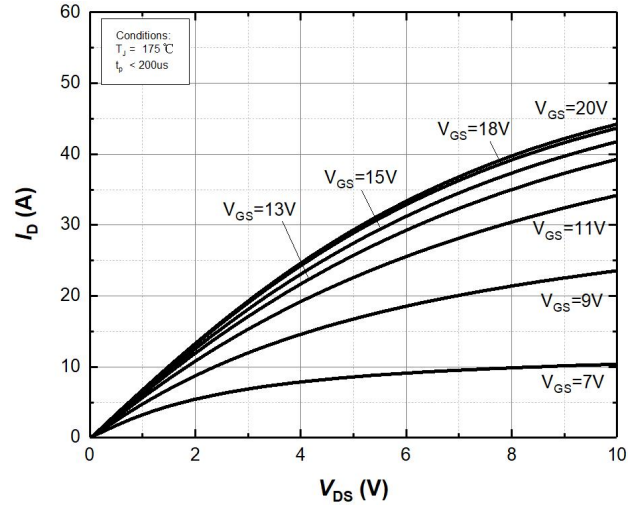

Figure 2. Output characteristics at $T_j=175^\circ\text{C}$

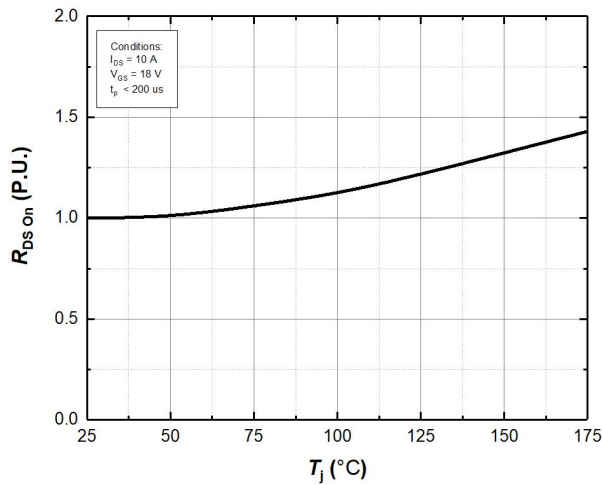

Figure 3. Normalized On-Resistance vs. Temperature

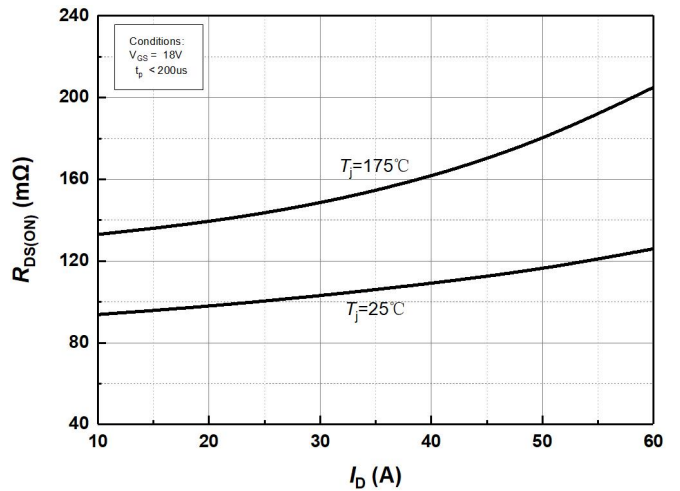

Figure 4. On-Resistance vs. Drain current for Various Temperature

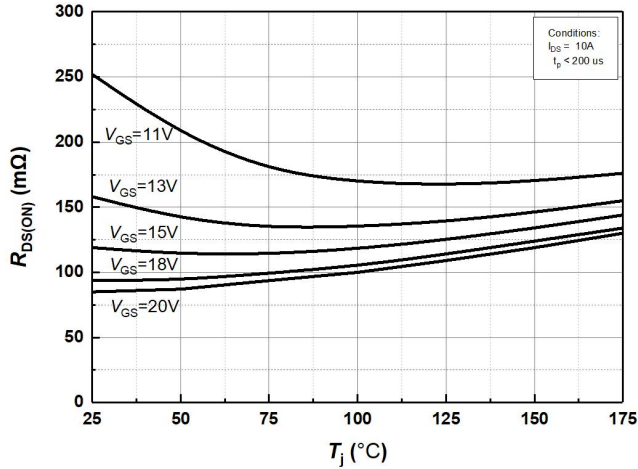

Figure 5. On-Resistance vs. Temperature for Various Gate Voltage

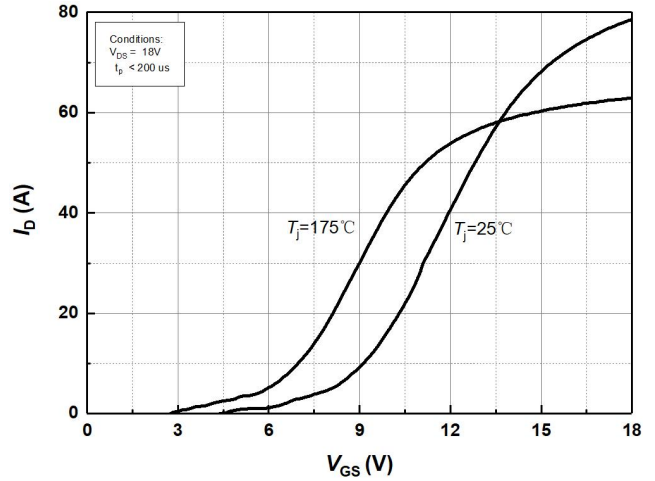

Figure 6. Transfer Characteristics for Various Junction Temperatures

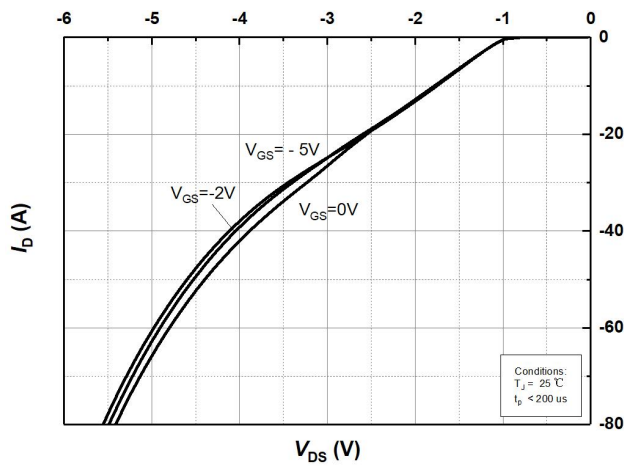

Figure 7. Body Diode Characteristics at $T_J=25^\circ C$

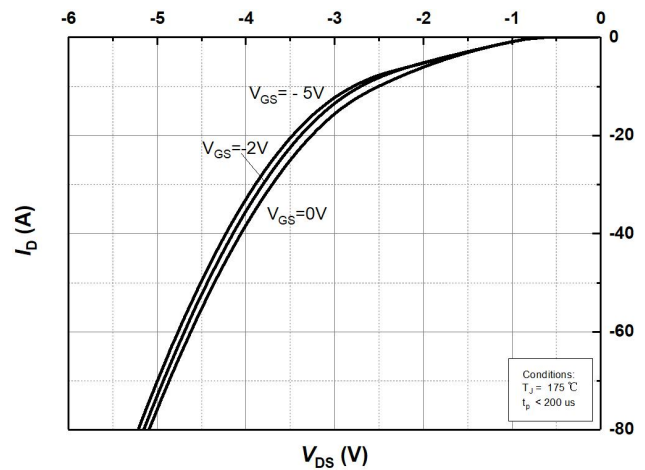

Figure 8. Body Diode Characteristics at $T_J=175^\circ C$

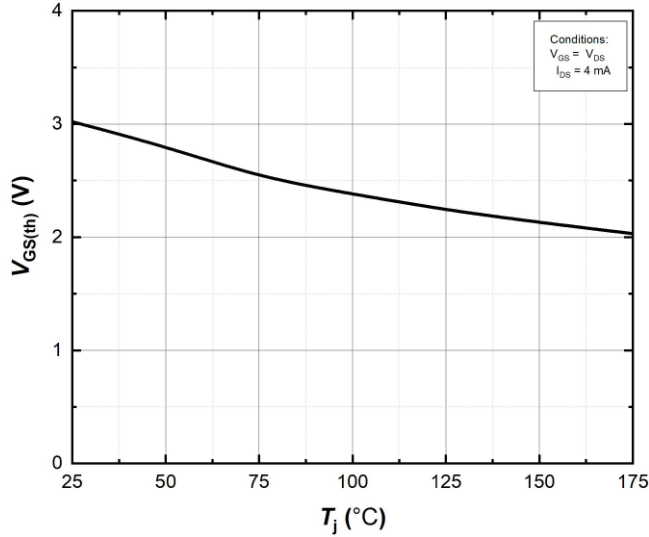

Figure 9. Threshold Voltage vs. Temperature

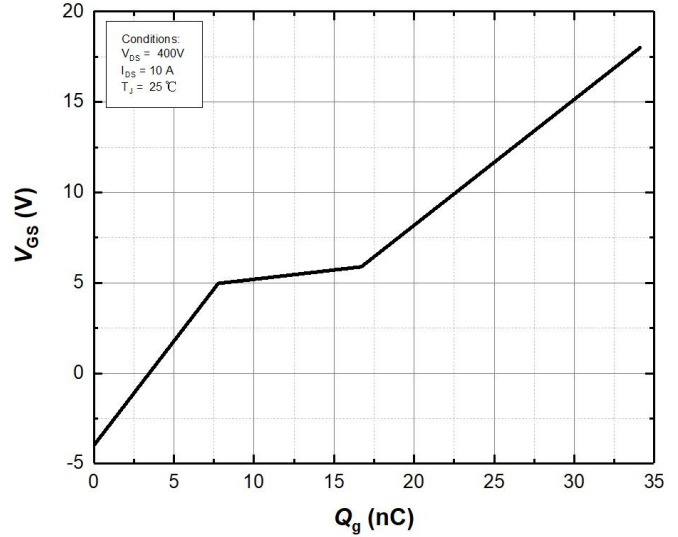

Figure 10 Gate Charge Characteristics

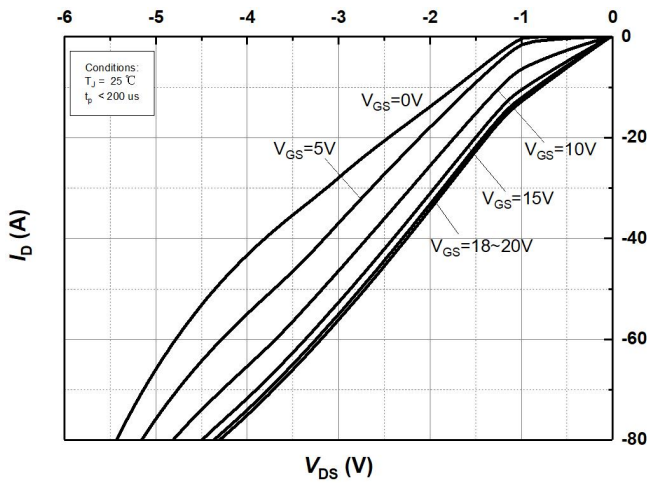

Figure 11. 3rd Quadrant Characteristic at $T_j=25^\circ\text{C}$

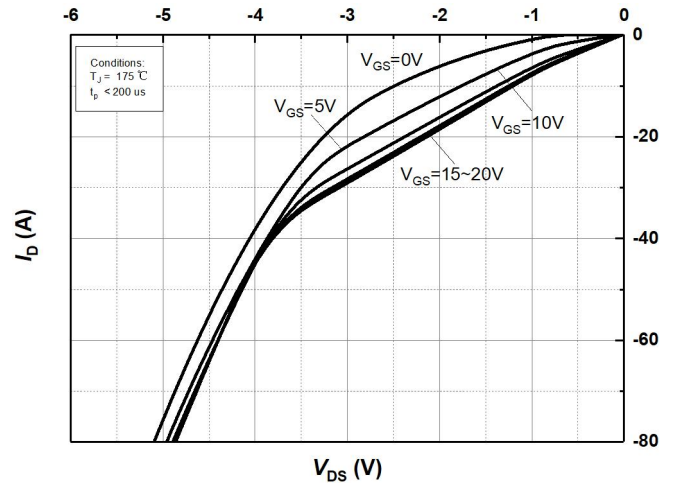

Figure 12. 3rd Quadrant Characteristic at $T_j=175^\circ\text{C}$

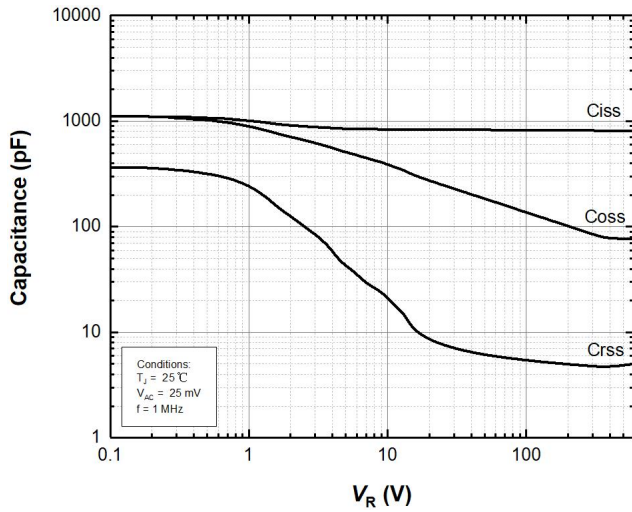

Figure 13. Capacitance vs. Drain-Source Voltage (0 – 600V)

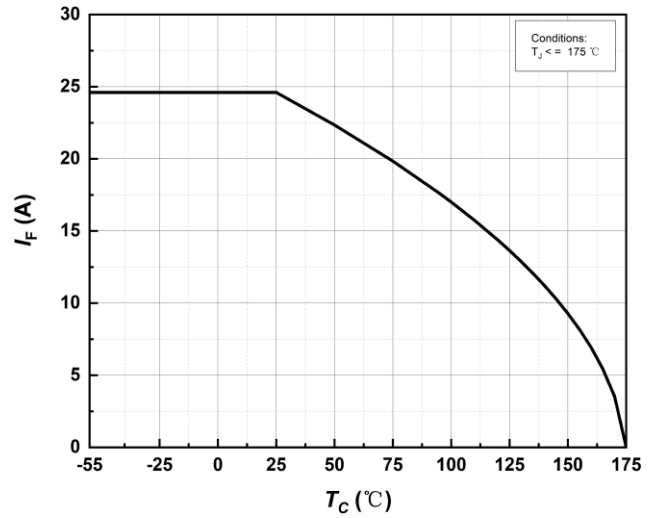

Figure 14. Continuous Drain Current Derating vs Case Temperature

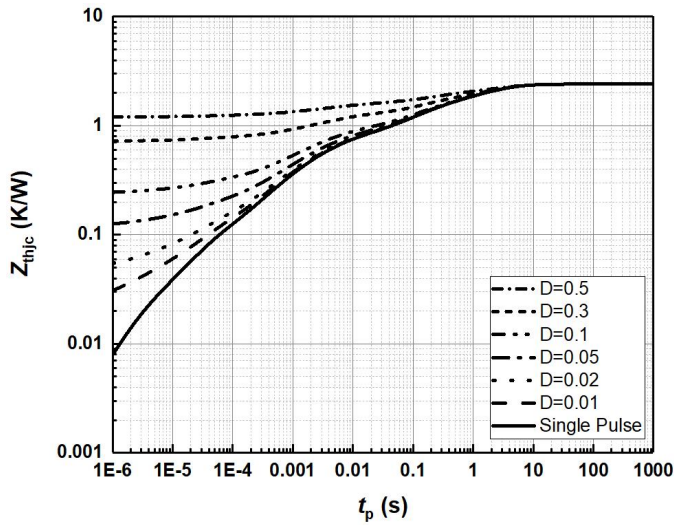

Figure 15. Transient Thermal Impedance (Junction – Case)

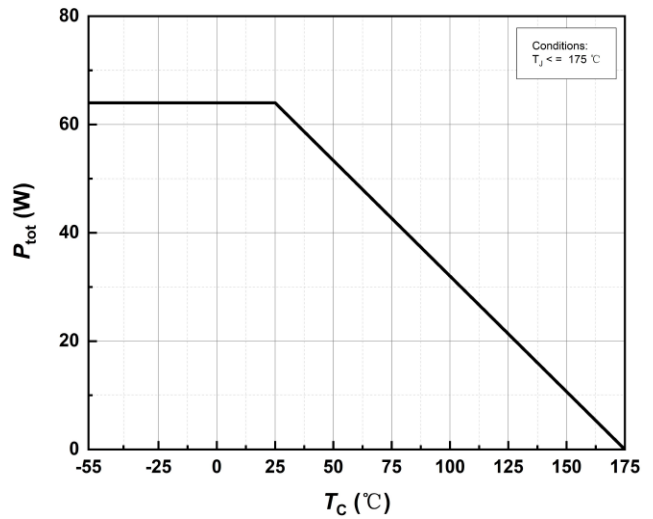

Figure 16. Maximum Power Dissipation Derating vs. Case Temperature

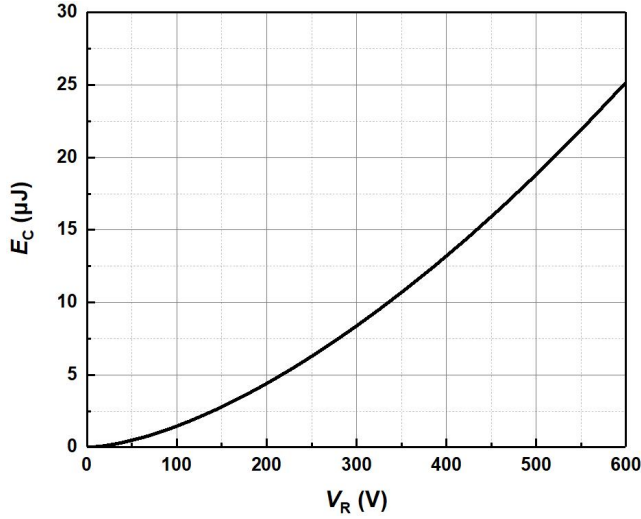

Figure 17. Output Capacitor Stored Energy

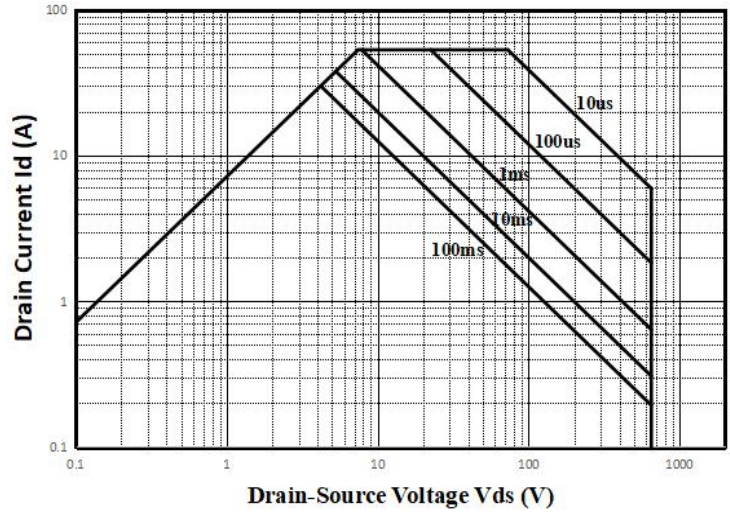

Figure 18. Safe Operating Area

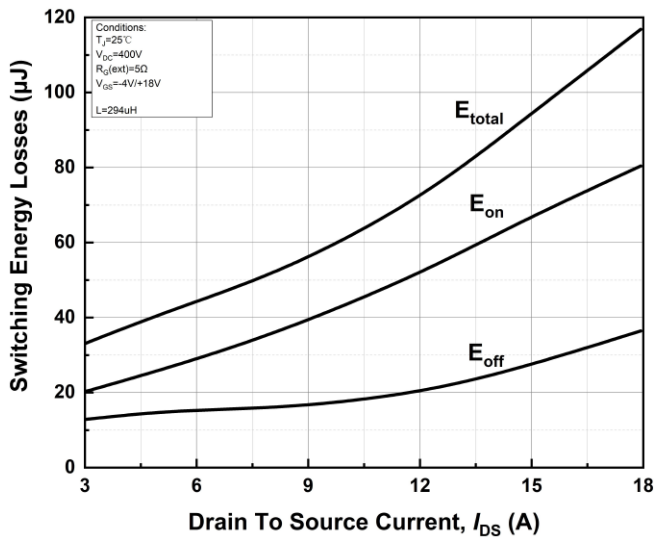

Figure 19. Clamped Inductive Switching Energy vs. Drain Current ($V_{DD} = 400\text{V}$)

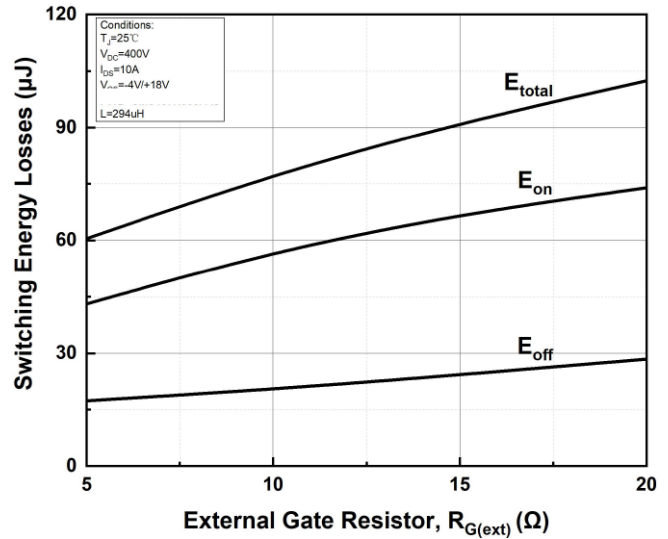

Figure 20. Clamped Inductive Switching Energy vs. $R_{G(ext)}$

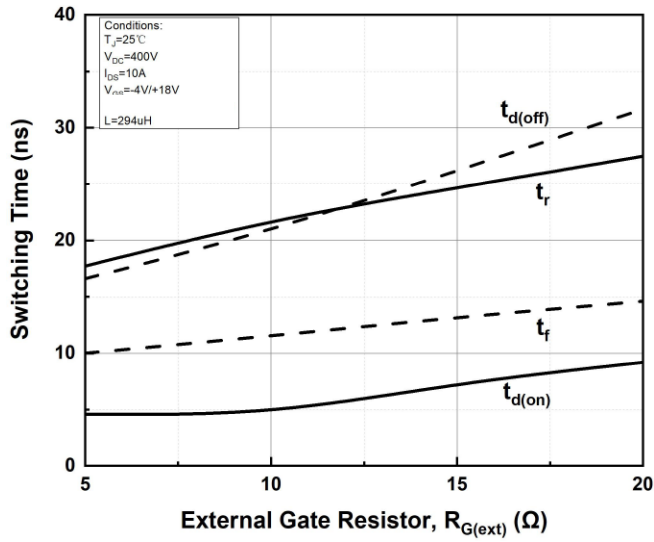
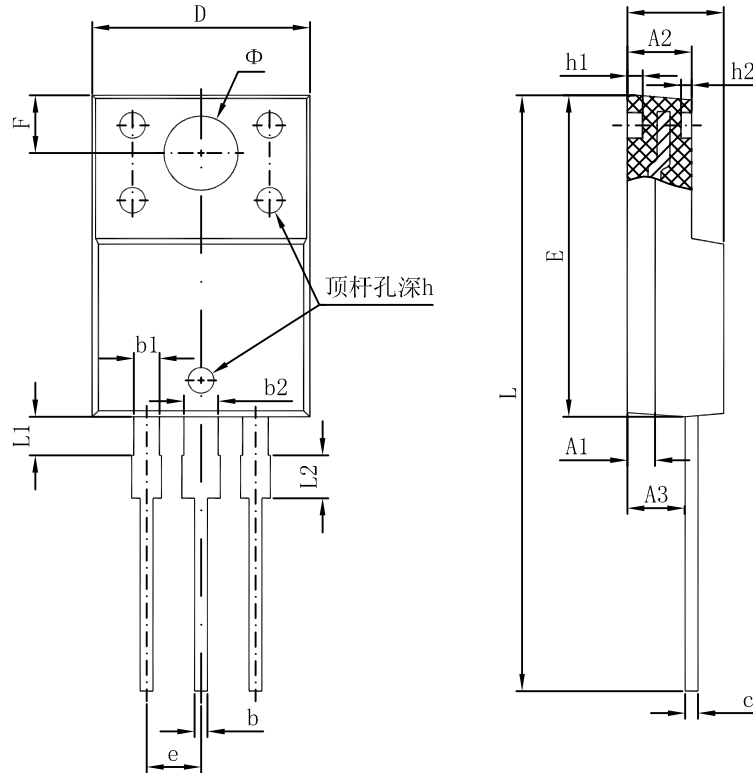

Figure 21. Switching Times vs. $R_{G(\text{ext})}$



Package Dimensions

Package TO-220F



Symbol	Dimensions In Millimeters		Dimensions In Inches	
	Min.	Max.	Min.	Max.
A	4.300	4.700	0.169	0.185
A1	1.300 REF.		0.051 REF.	
A2	2.800	3.200	0.110	0.126
A3	2.500	2.900	0.098	0.114
b	0.500	0.750	0.020	0.030
b1	1.100	1.350	0.043	0.053
b2	1.500	1.750	0.059	0.069
c	0.500	0.750	0.020	0.030
D	9.960	10.360	0.392	0.408
E	14.800	15.200	0.583	0.598
e	2.540 TYP.		0.100 TYP.	
F	2.700 REF.		0.106 REF.	
Φ	3.500 REF.		0.138 REF.	
h	0.000	0.300	0.000	0.012
h1	0.800 REF.		0.031 REF.	
h2	0.500 REF.		0.020 REF.	
L	28.000	28.400	1.102	1.118
L1	1.700	1.900	0.067	0.075
L2	1.900	2.100	0.075	0.083



Attention

- Any and all HUA XUAN YANG ELECTRONICS products described or contained herein do not have specifications that can handle applications that require extremely high levels of reliability, such as life-support systems, aircraft's control systems, or other applications whose failure can be reasonably expected to result in serious physical and/or material damage. Consult with your HUA XUAN YANG ELECTRONICS representative nearest you before using any HUA XUAN YANG ELECTRONICS products described or contained herein in such applications.
- HUA XUAN YANG ELECTRONICS assumes no responsibility for equipment failures that result from using products at values that exceed, even momentarily, rated values (such as maximum ratings, operating condition ranges, or other parameters) listed in products specifications of any and all HUA XUAN YANG ELECTRONICS products described or contained herein.
- Specifications of any and all HUA XUAN YANG ELECTRONICS products described or contained herein stipulate the performance, characteristics, and functions of the described products in the independent state, and are not guarantees of the performance, characteristics, and functions of the described products as mounted in the customer's products or equipment. To verify symptoms and states that cannot be evaluated in an independent device, the customer should always evaluate and test devices mounted in the customer's products or equipment.
- HUA XUAN YANG ELECTRONICS CO.,LTD. strives to supply high-quality high-reliability products. However, any and all semiconductor products fail with some probability. It is possible that these probabilistic failures could give rise to accidents or events that could endanger human lives, that could give rise to smoke or fire, or that could cause damage to other property. When designing equipment, adopt safety measures so that these kinds of accidents or events cannot occur. Such measures include but are not limited to protective circuits and error prevention circuits for safe design, redundant design, and structural design.
- In the event that any or all HUA XUAN YANG ELECTRONICS products(including technical data, services) described or contained herein are controlled under any of applicable local export control laws and regulations, such products must not be exported without obtaining the export license from the authorities concerned in accordance with the above law.
- No part of this publication may be reproduced or transmitted in any form or by any means, electronic or mechanical, including photocopying and recording, or any information storage or retrieval system, or otherwise, without the prior written permission of HUA XUAN YANG ELECTRONICS CO.,LTD.
- Information (including circuit diagrams and circuit parameters) herein is for example only ; it is not guaranteed for volume production. HUA XUAN YANG ELECTRONICS believes information herein is accurate and reliable, but no guarantees are made or implied regarding its use or any infringements of intellectual property rights or other rights of third parties.
- Any and all information described or contained herein are subject to change without notice due to product/technology improvement, etc. When designing equipment, refer to the "Delivery Specification" for the HUA XUAN YANG ELECTRONICS product that you intend to use.