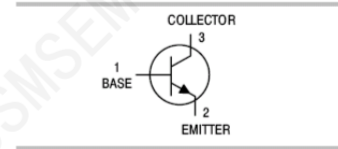
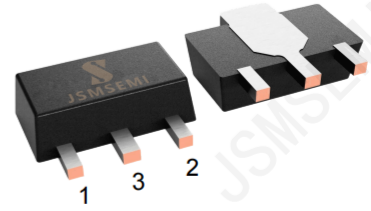

FEATURES

- For AF driver and output stages
- High collector current
- Low collector-emitter saturation voltage
- Complementary types: BCX51...BCX53(PNP)

SOT-89
ORDERING INFORMATION

Type No.	Marking	Package Code
BCX54,115-JSM	BA	SOT-89
BCX54-10,115-JSM	BC	SOT-89
BCX54-16,115-JSM	BD	SOT-89
BCX55,115-JSM	BE	SOT-89
BCX55-10,115-JSM	BG	SOT-89
BCX55-16,115-JSM	BM	SOT-89
BCX56,115-JSM	BH	SOT-89
BCX56-10,115-JSM	BK	SOT-89
BCX56-16,115-JSM	BL	SOT-89

MAXIMUM RATING @ Ta=25°C unless otherwise specified

Symbol	Parameter	Value	Unit
V _{CBO}	Collector-Base Voltage	BCX54	45
		BCX55	60
		BCX56	100
V _{CEO}	Collector-Emitter Voltage	BCX54	45
		BCX55	60
		BCX56	80
V _{EBO}	Emitter-Base Voltage	5	V
I _C	DC Collector Current	1	A
I _{CM}	Peak Collector Current	1.5	A
I _B	Base current	100	mA
I _{BM}	Peak base current	200	mA
P _{tot}	Total power dissipation, T _S =130°C	500	mW
T _j , T _{stg}	Junction and Storage Temperature	-65 to +150	°C

ELECTRICAL CHARACTERISTICS @ Ta=25°C unless otherwise specified

Parameter	Symbol	Test conditions	MIN	MAX	UNIT
Collector-base breakdown voltage	$V_{(BR)CBO}$	$I_C=100\mu A, I_B=0$ BCX54 BCX55 BCX56	45 60 100		V
Collector-emitter breakdown voltage	$V_{(BR)CEO}$	$I_C=10mA, I_B=0$ BCX54 BCX55 BCX56	45 60 80		V
Emitter-base breakdown voltage	$V_{(BR)EBO}$	$I_E=10\mu A, I_C=0$	5		V
Collector cut-off current	I_{CBO}	$V_{CB}=30V, I_E=0$		100	nA
		$V_{CB}=30V, I_E=0, T_A=150^\circ C$		20	μA
DC current gain	h_{FE}	$V_{CE}=2V, I_C=5mA$	25		
		$V_{CE}=2V, I_C=150mA$ BCX54...56	40	250	
		$V_{CE}=2V, I_C=150mA$ -10 -16	63 100	160 250	
		$V_{CE}=2V, I_C=500mA$	25		
Collector-emitter saturation voltage	$V_{CE(sat)}$	$I_C=500mA, I_B=50mA$		0.5	V
Base-emitter voltage	V_{BE}	$I_C=500mA, V_{CE}=2V$		1	V
Transition frequency	f_T	$V_{CE}=10V, I_C=50mA,$ $f=20MHz$	100		MHz

TYPICAL CHARACTERISTICS @ Ta=25°C unless otherwise specified

Total power dissipation $P_{tot} = f(T_S)$

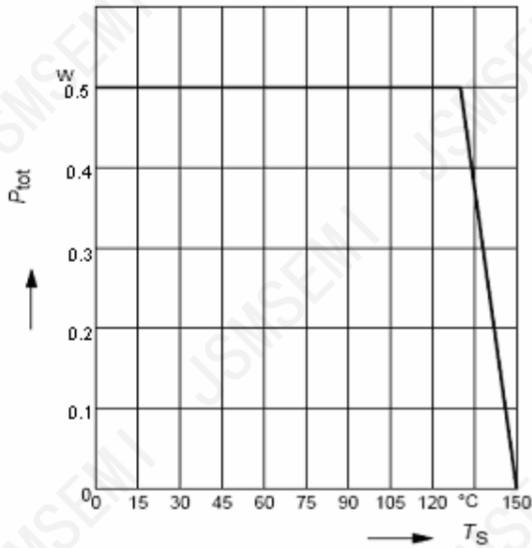

Transition frequency $f_T = f(I_C)$

$V_{CE} = 10V$

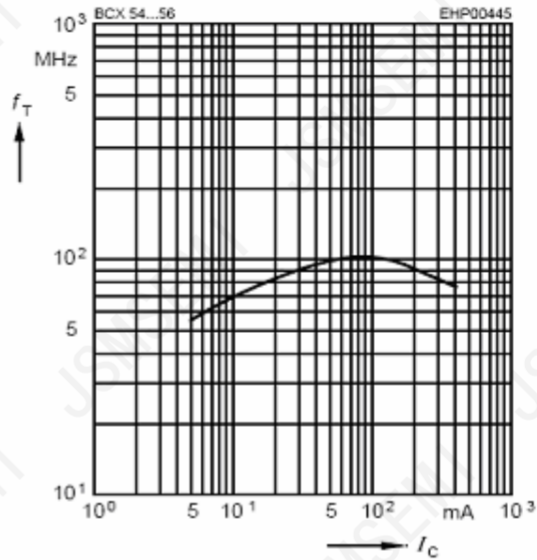

Collector current $I_C = f(V_{BE})$

$V_{CE} = 2V$

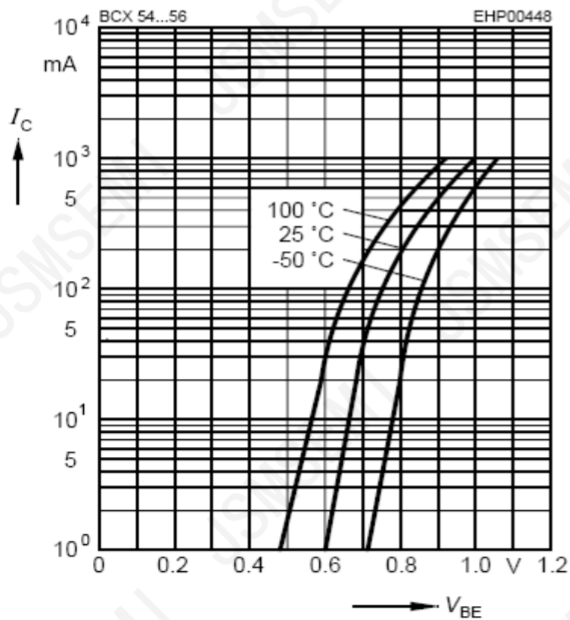

Collector-emitter saturation voltage

$I_C = f(V_{CEsat}), h_{FE} = 10$

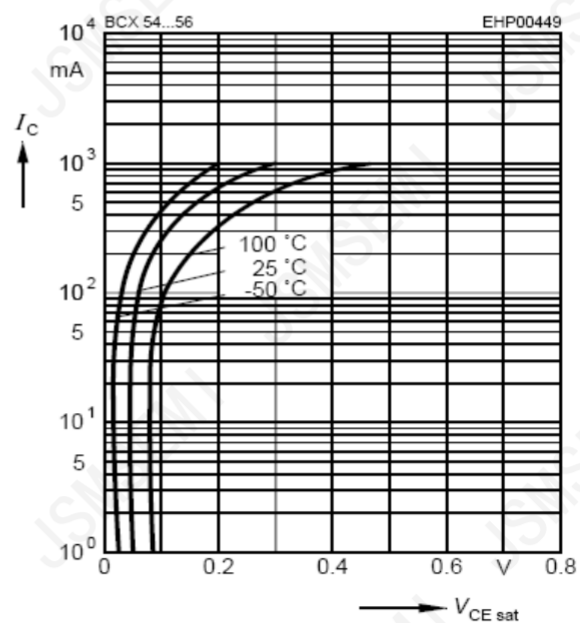

Base-emitter saturation voltage

$I_C = f(V_{BEsat}), h_{FE} = 10$

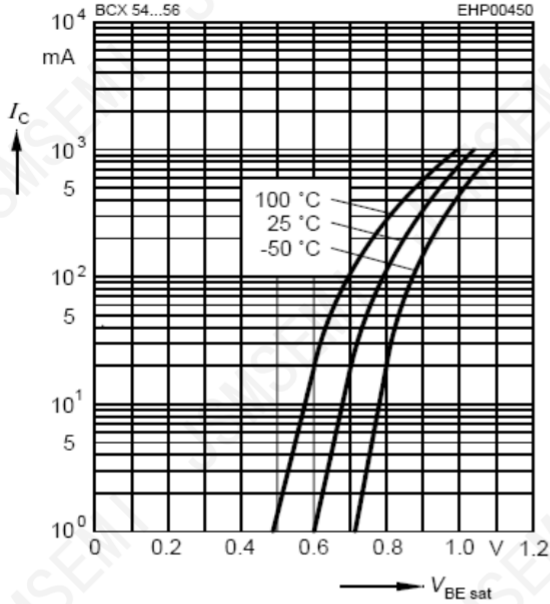

DC current gain $h_{FE} = f(I_C)$

$V_{CE} = 2V$

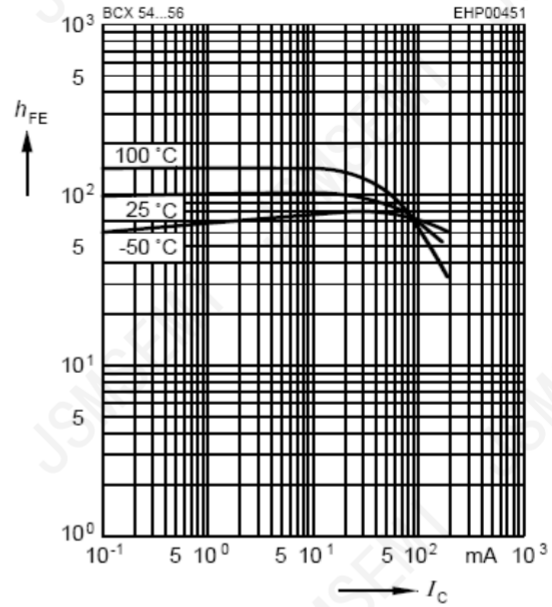

Collector cutoff current $I_{CBO} = f(T_A)$

$V_{CB} = 30V$

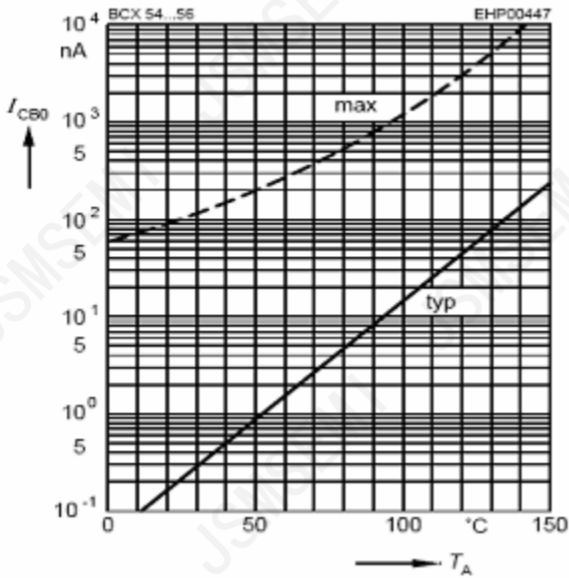

PACKAGE OUTLINE

Plastic surface mounted package

SOT-89

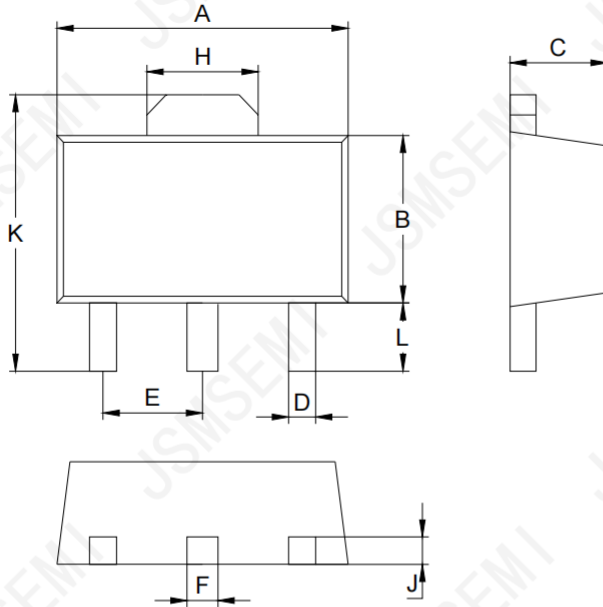

SOT-89		
Dim	Min	Max
A	4.30	4.70
B	2.25	2.65
C	1.50 Typical	
D	0.40 Typical	
E	1.40	1.60
F	0.48 Typical	
H	1.60	1.80
J	0.40 Typical	
L	0.90	1.10
K	3.95	4.35
All Dimensions in mm		

SOLDERING FOOTPRINT

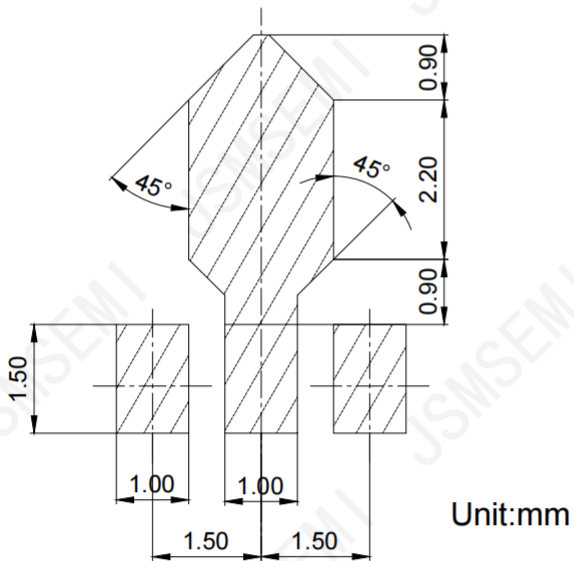

PACKAGE INFORMATION

Device	Package	Shipping
BCX54-16,115-JSM	SOT-89	1000/Tape&Reel

Revision History

Rev.	Change	Date
V1.0	Initial version	2/23/2024

Important Notice

JSMSEMI Semiconductor (JSMSEMI) PRODUCTS ARE NEITHER DESIGNED NOR INTENDED FOR USE IN MILITARY AND/OR AEROSPACE, AUTOMOTIVE OR MEDICAL DEVICES OR SYSTEMS UNLESS THE SPECIFIC JSMSEMI PRODUCTS ARE SPECIFICALLY DESIGNATED BY JSMSEMI FOR SUCH USE. BUYERS ACKNOWLEDGE AND AGREE THAT ANY SUCH USE OF JSMSEMI PRODUCTS WHICH JSMSEMI HAS NOT DESIGNATED FOR USE IN MILITARY AND/OR AEROSPACE, AUTOMOTIVE OR MEDICAL DEVICES OR SYSTEMS IS SOLELY AT THE BUYER' S RISK.

JSMSEMI assumes no liability for application assistance or customer product design. Customers are responsible for their products and applications using JSMSEMI products.

Resale of JSMSEMI products or services with statements diferent from or beyond the parameters stated by JSMSEMI for that product or service voids all express and any implied warranties for the associated JSMSEMI product or s ervice. JSMSEMI is not responsible or liable for any such statements.

JSMSEMI All Rights Reserved. Information and data in this document are owned by JSMSEMI wholly and may not be edited, reproduced, or redistributed in any way without the express written consent from JSMSEMI.

Any and all information described or contained herein are subject to change without notice due to product/technology improvement, etc. When designing equipment, refer to the "Delivery Specification" for the JSMSEMI product that you intend to use.

For additional information please contact Kevin@jsmsemi.com or visit www.jsmsemi.com