

版本	变更内容	工程确认	日期

A

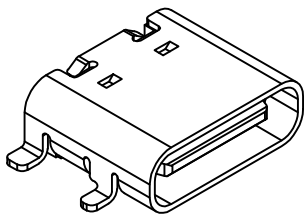

B

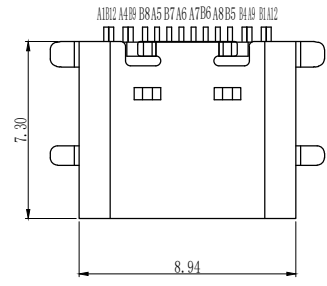
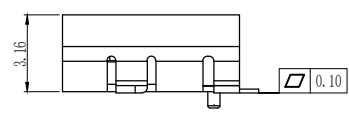
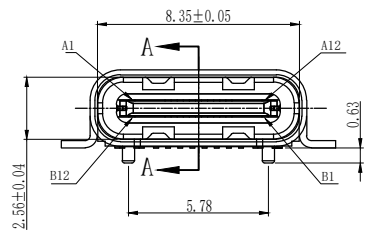

C

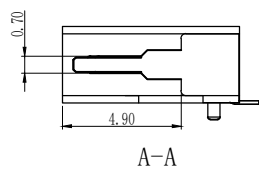
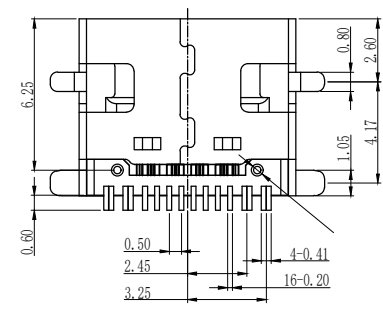

D

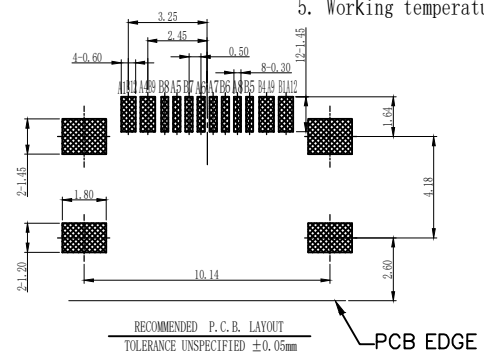

E

A1	GND	B12	GND
A4	VBUS	B9	VBUS
A5	CC1	B8	SBU2
A6	DP1	B7	DN2
A7	DN1	B6	DP2
A8	SBU1	B5	CC2
A9	VBUS	B4	VBUS
A12	GND	B1	GND
PIN	SIGNAL NAME	PIN	SIGNAL NAME

yi YUAN 深圳市怡远科技有限公司
SHENZHEN YIYUAN TECHNOLOGY CO., LTD

品名 (ITEM NO) Type C 母座 16P 板上 SMT 全贴
料号 (PART NO) YTC-TC16-273AS
图号 (DWG NO)

页码 (SHEET)	1/1	单位 (UNIT) : MM
版本 (REV)	A1	比例 (SCALE)
日期 (DATE)	2021. 10. 12	
设计 (DESIGN)	LUO	未注公差 TOLERANCE UNSPECIFIED
审核 (CHECKED)	ROGER LI	X.X ±0.20 X.XX ±0.15 X.XXX ±0.10
核准 (APPROVED)	ROC ZHAO	X° ±5° X.X° ±2°

F

These drawings and specifications are Shenzhen Yiyuan Technology Co Ltd. The property should not be copied. Without Shenzhen Yiyuan Technology Co. Ltd. Prior written consent to copy or use in any way Email at info@yiyuanswitches.com