

### Product Summary

- $V_{DS}$  100 V
- $I_{DS}$  (at  $V_{GS}=10V$ ) 50A
- $R_{DS(ON)}$  (at  $V_{GS}=10V$ )  $\leq 12.5m\Omega$  (TYP)

### Application

- Load switch
- High Frequency Switching and Synchronous Rectification
- Active Clamp in Intermediate
- DC/DC Power Supplies

### Package and Pin Configuration

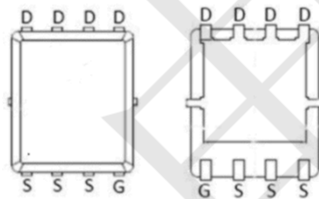

### Circuit diagram

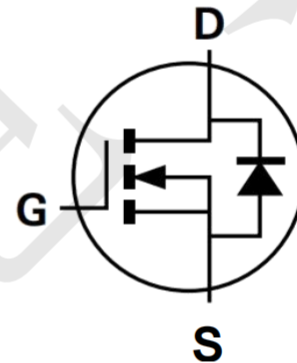

PDFN5X6-8

### Absolute Maximum Ratings

( $T_A=25^\circ C$  unless otherwise noted)

PARAMETER	SYMBOL	LIMIT	UNIT
Drain-Source Voltage	$V_{DS}$	100	V
Gate-Source Voltage	$V_{GS}$	$\pm 20$	V
Continuous Drain Current	$I_D$	$T_C=25^\circ C$	50
		$T_C=100^\circ C$	42
Pulsed Drain Current	$I_{DM}$	85	A
Single Pulse Avalanche Energy	EAS	55	mJ
Total Power Dissipation	$P_{TOT}$	57	W
Operating Junction Temperature Range	$T_J$	-55 to +150	$^\circ C$
Storage Temperature Range	$T_{stg}$	-55 to +150	$^\circ C$

### Thermal Characteristic

PARAMETER	Symbol	Value	Unit
Junction-to-Ambient Thermal Resistance	$R_{\theta JA}$	62	$^\circ C/W$
Thermal Resistance Junction-Case	$R_{\theta JC}$	2.2	$^\circ C/W$

Note : The data tested by surface mounted on a 1 inch2 FR-4 board with 2OZ copper.

### Electrical Characteristics (T<sub>A</sub>=25°C unless otherwise noted)

PARAMETER	CONDITIONS	SYMBOL	MIN	TYP	MAX	UNIT
<b>Static</b>						
Drain-Source Breakdown Voltage	V <sub>GS</sub> =0V, I <sub>D</sub> =250μA	BV <sub>DSS</sub>	100	--	--	V
Gate-Source Threshold Voltage	V <sub>DS</sub> =V <sub>GS</sub> , I <sub>D</sub> =250μA	V <sub>GS(th)</sub>	2.0	3.0	4.0	V
Gate-Source Leakage	V <sub>DS</sub> =0V, V <sub>GS</sub> =±20V	I <sub>GSS</sub>	--	--	±100	nA
Zero Gate Voltage Drain Current	V <sub>DS</sub> =80V, V <sub>GS</sub> =0V	I <sub>DSS</sub>	--	0.1	1.0	μA
	V <sub>DS</sub> =80V, T <sub>J</sub> =55°C		--	1.0	5.0	μA
Drain-Source On-State Resistance (Note 1)	V <sub>GS</sub> =10V, I <sub>D</sub> =15A	R <sub>DS(on)</sub>	--	12.5	20	mΩ
	V <sub>GS</sub> =4.5V, I <sub>D</sub> =8A		--	21	35	
Forward Transconductance (Note 2)	V <sub>DS</sub> =5V, I <sub>D</sub> =20A	g <sub>fs</sub>	--	72	--	S
<b>Dynamic (Note 2)</b>						
Total Gate Charge (Note 3)	V <sub>DS</sub> =50V, I <sub>D</sub> =20A, V <sub>GS</sub> =10V	Q <sub>g</sub>	--	40	--	nC
Gate-Source Charge (Note 3)		Q <sub>gs</sub>	--	7.1	--	
Gate-Drain Charge (Note 3)		Q <sub>gd</sub>	--	6.2	--	
Input Capacitance	V <sub>DS</sub> =50V, V <sub>GS</sub> =0V, F=1.0MHz	C <sub>iss</sub>	--	2800	--	pF
Output Capacitance		C <sub>oss</sub>	--	400	--	
Reverse Transfer Capacitance		C <sub>rss</sub>	--	36	--	
<b>Switching</b>						
Turn-On Delay Time (Note 3)	V <sub>DD</sub> =30V, I <sub>D</sub> =1A, V <sub>GS</sub> =10V, R <sub>G</sub> =3.3Ω	t <sub>d(on)</sub>	--	8.1	--	nS
Rise Time (Note 3)		t <sub>r</sub>	--	4.5	--	
Turn-Off Delay Time (Note 3)		t <sub>d(off)</sub>	--	37	--	
Fall Time (Note 3)		t <sub>f</sub>	--	6.6	--	
<b>Source-Drain Diode Ratings and Characteristics (Note 2)</b>						
Forward Voltage	V <sub>GS</sub> =0V, I <sub>F</sub> =10A	V <sub>SD</sub>	--	0.7	1.2	V
Continuous Source Current	Integral reverse diode in the MOSFET	I <sub>S</sub>	--	--	50	A
Pulsed Current (Note 1)		I <sub>SM</sub>	--	--	85	A

Notes:

1. Pulse test; pulse width ≤ 300 μS, duty cycle ≤ 2%.
2. Guaranteed by design, not subject to production testing.
3. Independent of operating temperature

### Typical Electrical and Thermal Characteristics

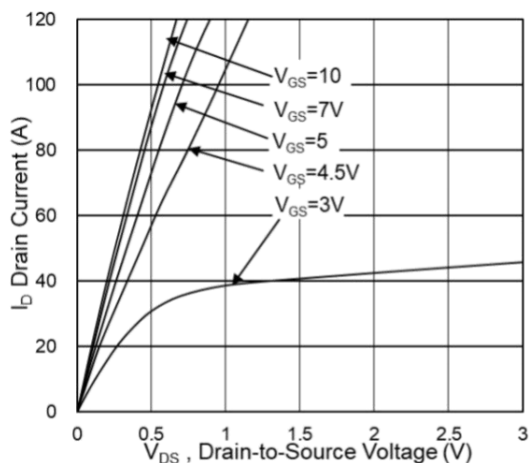

Fig.1 Typical Output Characteristics

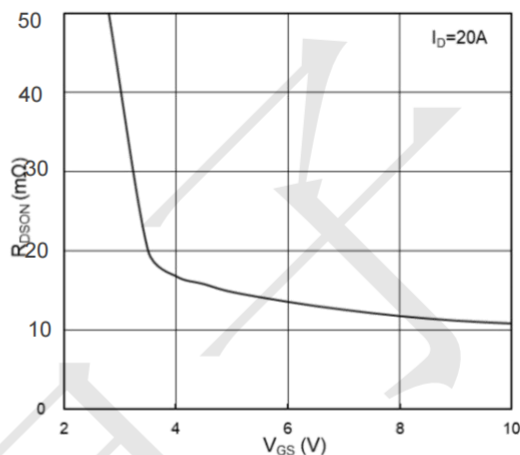

Fig.2 On-Resistance vs G-S Voltage

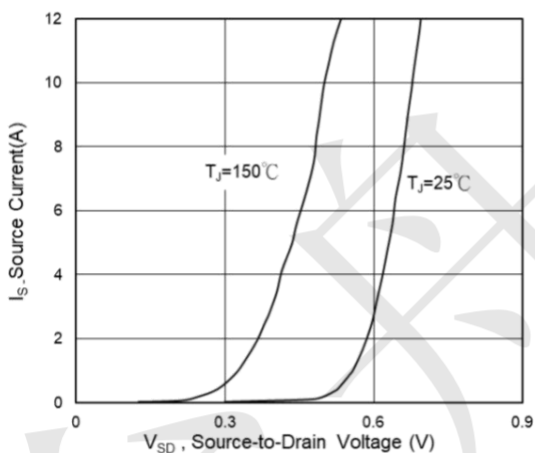

Fig.3 Source Current vs Source-to-Drain Voltage

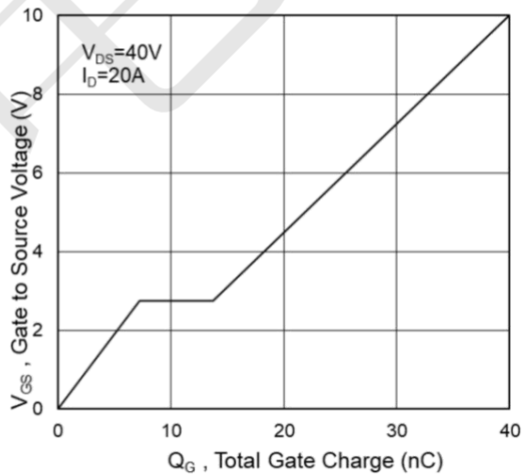

Fig.4 Gate to Source Voltage vs Total Gate Charge

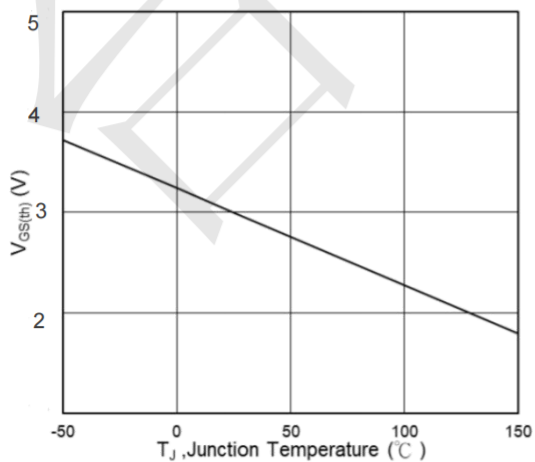

Fig.5 Normalized  $V_{GS(th)}$  vs.  $T_J$

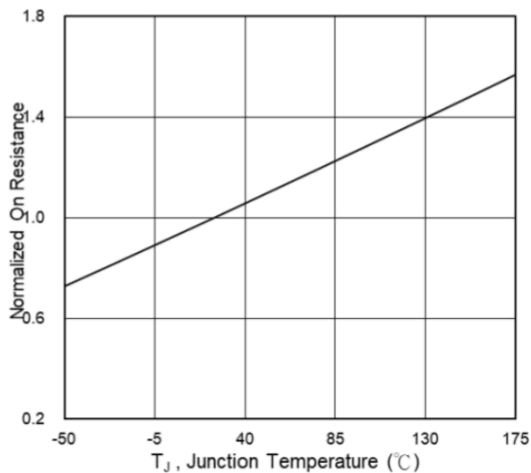
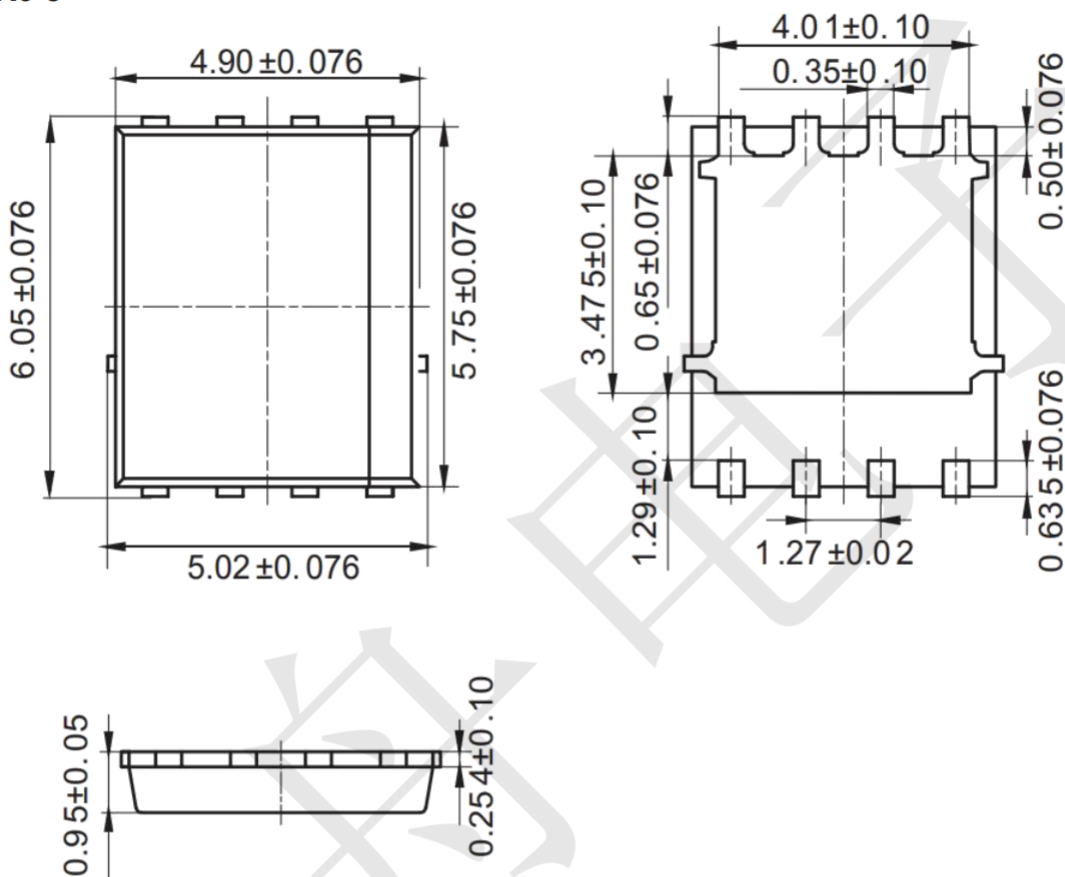

Fig.6 Normalized  $R_{DS(on)}$  vs.  $T_J$

**Package Information**

PDFN5X6-8



**Mounting Pad Layout (unit: mm)**

