

Product Summary

- V_{DS} 100 V
- I_{DS} (at $V_{GS}=10V$) 50A
- $R_{DS(ON)}$ (at $V_{GS}=10V$) $\leq 12.5m\Omega$ (TYP)

Application

- Load switch
- High Frequency Switching and Synchronous Rectification
- Active Clamp in Intermediate
- DC/DC Power Supplies

Package and Pin Configuration

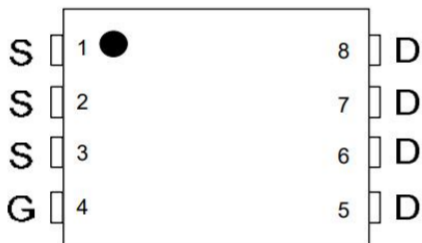

PDFN5X6-8

Circuit diagram

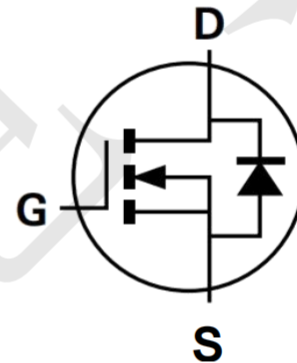

Absolute Maximum Ratings

($T_A=25^\circ C$ unless otherwise noted)

PARAMETER	SYMBOL	LIMIT	UNIT
Drain-Source Voltage	V_{DS}	100	V
Gate-Source Voltage	V_{GS}	± 20	V
Continuous Drain Current	I_D	$T_C=25^\circ C$	50
		$T_C=100^\circ C$	42
Pulsed Drain Current	I_{DM}	85	A
Single Pulse Avalanche Energy	EAS	55	mJ
Total Power Dissipation	P_{TOT}	57	W
Operating Junction Temperature Range	T_J	-55 to +150	$^\circ C$
Storage Temperature Range	T_{stg}	-55 to +150	$^\circ C$

Thermal Characteristic

PARAMETER	Symbol	Value	Unit
Junction-to-Ambient Thermal Resistance	$R_{\theta JA}$	62	$^\circ C/W$
Thermal Resistance Junction-Case	$R_{\theta JC}$	2.2	$^\circ C/W$

Note : The data tested by surface mounted on a 1 inch2 FR-4 board with 2OZ copper.

Electrical Characteristics (T_A=25°C unless otherwise noted)

PARAMETER	CONDITIONS	SYMBOL	MIN	TYP	MAX	UNIT
Static						
Drain-Source Breakdown Voltage	V _{GS} =0V, I _D =250μA	BV _{DSS}	100	--	--	V
Gate-Source Threshold Voltage	V _{DS} =V _{GS} , I _D =250μA	V _{GS(th)}	2.0	3.0	4.0	V
Gate-Source Leakage	V _{DS} =0V, V _{GS} =±20V	I _{GSS}	--	--	±100	nA
Zero Gate Voltage Drain Current	V _{DS} =80V, V _{GS} =0V	I _{DSS}	--	0.1	1.0	μA
	V _{DS} =80V, T _J =55°C		--	1.0	5.0	μA
Drain-Source On-State Resistance (Note 1)	V _{GS} =10V, I _D =15A	R _{DS(on)}	--	12.5	20	mΩ
	V _{GS} =4.5V, I _D =8A		--	21	35	
Forward Transconductance (Note 2)	V _{DS} =5V, I _D =20A	g _{fs}	--	72	--	S
Dynamic (Note 2)						
Total Gate Charge (Note 3)	V _{DS} =50V, I _D =20A, V _{GS} =10V	Q _g	--	40	--	nC
Gate-Source Charge (Note 3)		Q _{gs}	--	7.1	--	
Gate-Drain Charge (Note 3)		Q _{gd}	--	6.2	--	
Input Capacitance	V _{DS} =50V, V _{GS} =0V, F=1.0MHz	C _{iss}	--	2800	--	pF
Output Capacitance		C _{oss}	--	400	--	
Reverse Transfer Capacitance		C _{rss}	--	36	--	
Switching						
Turn-On Delay Time (Note 3)	V _{DD} =30V, I _D =1A, V _{GS} =10V, R _G =3.3Ω	t _{d(on)}	--	8.1	--	nS
Rise Time (Note 3)		t _r	--	4.5	--	
Turn-Off Delay Time (Note 3)		t _{d(off)}	--	37	--	
Fall Time (Note 3)		t _f	--	6.6	--	
Source-Drain Diode Ratings and Characteristics (Note 2)						
Forward Voltage	V _{GS} =0V, I _F =10A	V _{SD}	--	0.7	1.2	V
Continuous Source Current	Integral reverse diode in the MOSFET	I _S	--	--	50	A
Pulsed Current (Note 1)		I _{SM}	--	--	85	A

Notes:

1. Pulse test; pulse width ≤ 300 μS, duty cycle ≤ 2%.
2. Guaranteed by design, not subject to production testing.
3. Independent of operating temperature

Typical Electrical and Thermal Characteristics

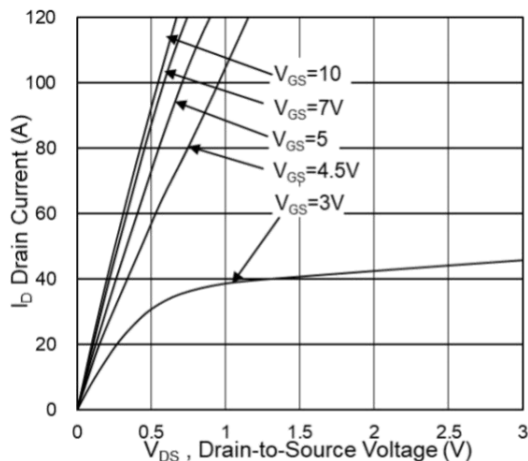

Fig.1 Typical Output Characteristics

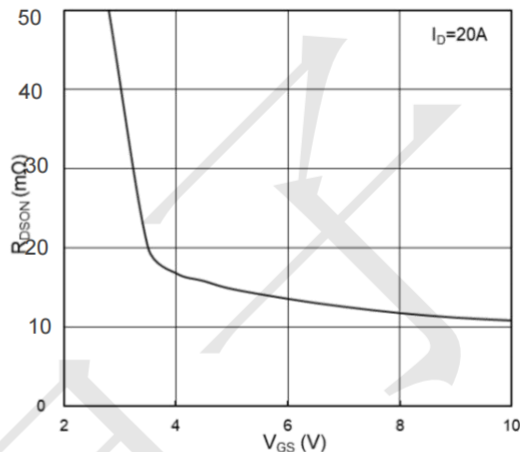

Fig.2 On-Resistance vs G-S Voltage

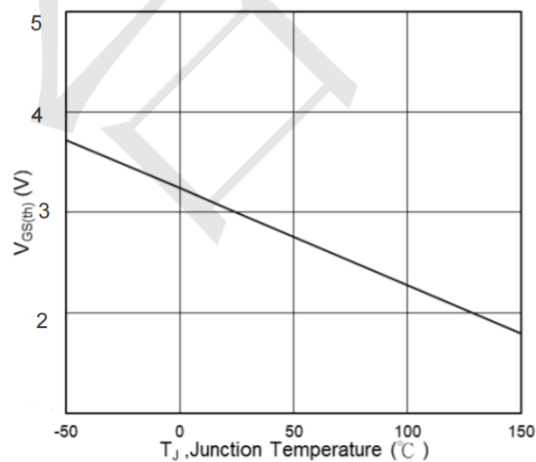
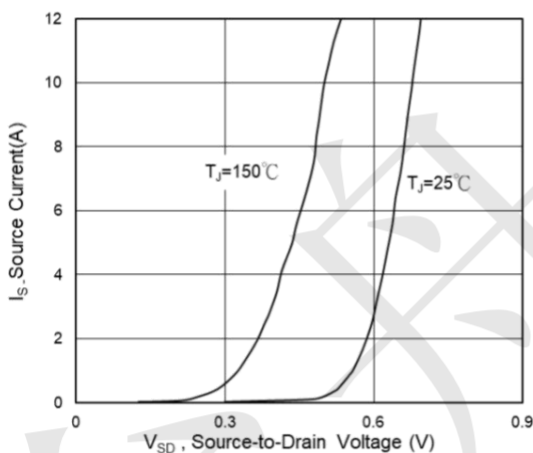

Fig.5 Normalized $V_{GS(th)}$ vs. T_J

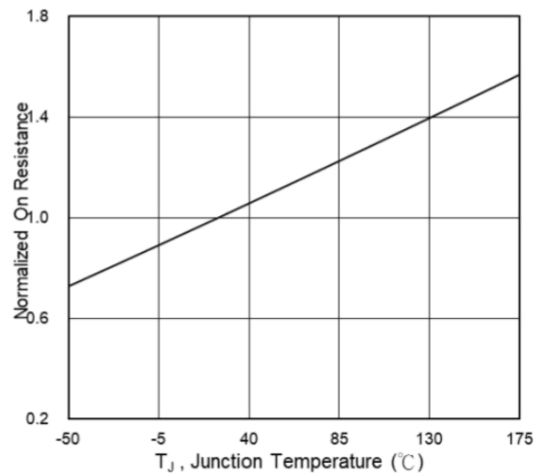
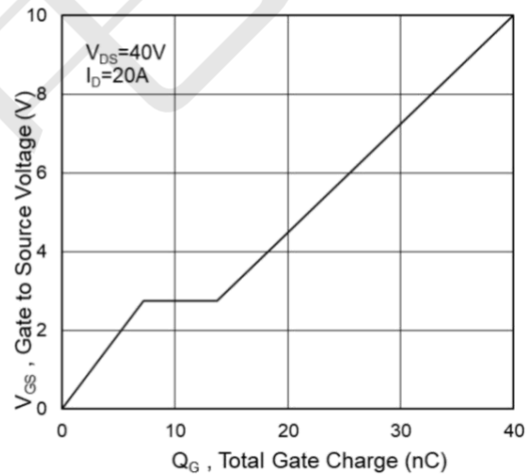
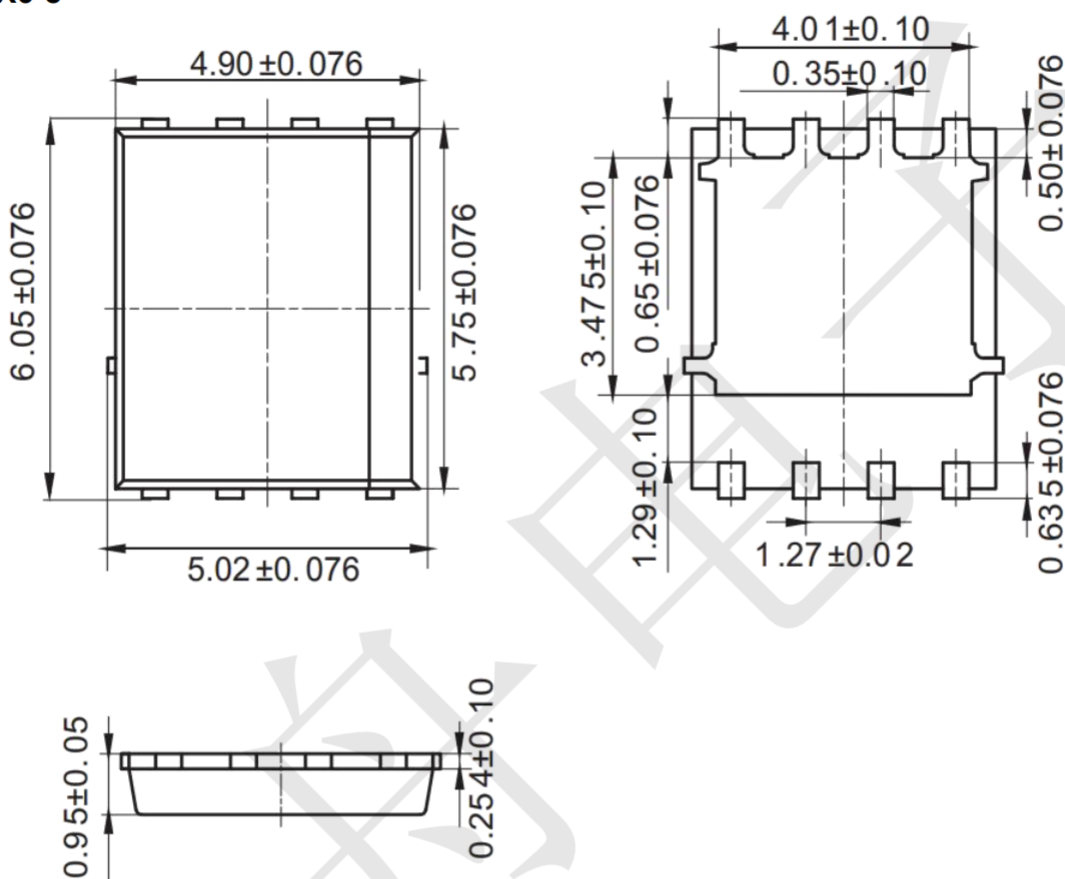

Fig.6 Normalized $R_{DS(on)}$ vs. T_J

Package Information

PDFN5X6-8



Mounting Pad Layout (unit: mm)

